



7880-7881-7882-7885

EXPERT TV METERS

USER MANUAL

This product contains one or more programs protected under international and US copyright laws as unpublished works. They are confidential and proprietary to Dolby laboratories. Their reproduction or disclosure, in whole or in part, or the production of derivative works therefrom without the express permission of Dolby Laboratories is prohibited. Copyright 2003-2005 by Dolby Laboratories. All rights reserved.

Revision follow-up

Version / Date	Page or §	Changes
1.0 / november 2017	All	First edition

Thank you for purchasing this SEFRAM product and therefore trusting our company. Our different teams (research department, production, sales department, after-sales service...) are aiming at satisfying your wishes by designing and updating very advanced appliances.

To obtain the best performance from this product please read this manual carefully.

For more information please contact our different services

E-mail Sales department: sales@sefram.fr

E-mail After-sales: sav@sefram.fr

E-mail Technical support: support@sefram.fr

Tel: +33 (0)4 77 59 01 01

Fax: +33 (0)4 77 57 23 23

Web: www.sefram.fr



GUARANTEE

Your instrument is guaranteed for two years for labor and parts against any manufacturing defect and/or functioning hazard. This guarantee extends from the delivery date and ends 730 calendar days later.

In case of guarantee contract, this will cancel or replace these guarantee conditions hereabove.

The guarantee conditions by SEFRAM are available on the website www.sefram.com. The general guarantee conditions should prevail on the following conditions that they sum up.

This guarantee does not cover the result of any abnormal use, handling mistake or mistake in the storage conditions outside the defined range.

In case of application of the guarantee, the user shall return, at its own expenses, the relevant appliance to our factory:

SEFRAM Instruments & Systèmes
Service Après-Vente
32, Rue Edouard MARTEL
BP 55
42009 SAINT-ETIENNE CEDEX 2

And add a description of the observed breakdown to the appliance.

The standard supplies provided with the appliance (cables, outlets...), the consumables (batteries ...) and the optional supplies (suitcases...) are guaranteed for 3 months against any manufacturing defect.

Such items as a suitcase, a LCD screen or a touchpad are guaranteed only for a normal use.

The guarantee does not cover wearing, accidental breaks or consecutive to a shock or any abnormal use.

The factory options integrated to the appliance are guaranteed for the same duration as the appliance itself.

In case of replacement or repair of the product, the remaining guarantee duration shall be:

- The remaining duration of the guarantee if the appliance is still under guarantee
- If the guarantee duration is less than 90 days, the replaced part is guaranteed for 90 days

Any replacement part becomes the property of the user and the exchanged parts become the property of SEFRAM.

In case of intervention by an insurance company, the product becomes the property of the insurance company upon its exclusive request. Else, it shall remain property of the user.

The guarantee covers exclusively the materials manufactured and provided by SEFRAM.

Any intervention by the user or any third party without prior authorization by the company voids the guarantee.

The user shall be responsible for the return of its appliance to our site. Hence, it shall provide for a conditioning that shall correctly protect the appliance while shipping. It shall subscribe, at its own expenses, any insurance required for the transport.

The SEFRAM company reserves the right to refuse any product wrongly conditioned and not to take in charge any break consecutive to the transport.

Particular case of the battery: There is a Li-ion battery as a standard equipment of this appliance. It shall not be transported outside the appliance. In no case shall the user replace it. Its replacement in the factory is necessary to check the charge system and the protective securities.

What to do in case of malfunction?

In case of malfunction or for any advice for use, please contact the technical support by SEFRAM Instruments & Systèmes.

A technician shall answer you and give you any information required to solve your problem.

What to do in case of failure?

In case of failure of your appliance, please contact the after-sales support.

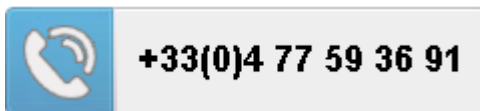

Some advice!

Some technical help!

SEFRAM Instruments & Systèmes commits itself to help you on the phone about the use of your appliance.

Please call or Technical Support:

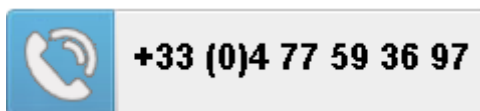

Or e-mail:

support@sefram.fr

We thank you for your trust.

METROLOGY

The meteorological conditions of your measurement instrument are defined in the specifications of this notice. Climate and environmental conditions restrict the specifications of your Field Strength Measurer (MDC). SEFRAM checks the characteristics of each appliance one by one on an automatic bench during its manufacture. The adjustment and control are guaranteed under conditions of the ISO9001 certification by facilities in connection with the COFRAC (or equivalent in the context of ILAC reciprocity).

The specified characteristics are considered stable for a period of 12 months from the first use under normal conditions of use. We recommend a check after 12 months and max. 24 months of use, then every 12 months after 24 months.

For any check of the characteristics, the following average climate conditions shall be maintained ($23^{\circ}\text{C}\pm 3^{\circ}\text{C} - 50(\pm 20)\% \text{RH}$). The MDC should have been working for 0,5 hour before check.

We recommend that you have this control made by our after-sales service (Service Après-Vente) for the best service and preservation of the measuring quality of your instrument.

When a MDC returns to SEFRAM, maximum service is provided with internal updating according to the required adjustments and software updates. In case of shift in the characteristics, your instrument shall be adjusted to recover its original characteristics.

PACKAGING

The packaging of this product is fully recyclable. Its design allows the transport of your instrument under the best possible conditions. Please note that the original packaging should be additionally wrapped in case of transport by air, road or postal.

TABLE OF CONTENTS

1	Important information	10
1.1	Particular precautions	10
1.2	Security instructions	10
1.3	Conformity and restrictions of the appliance	10
2	Quick start-up	11
2.1	Presentation of the appliance	11
2.2	Signal spotting	13
2.2.1	Checking a terrestrial antenna	13
2.2.2	Installation of a terrestrial antenna	14
2.2.2.1	Using Spectrum function	14
2.2.2.1	Using Pointing function	16
2.2.3	Installation of a satellite dish	17
2.2.3.1	Using Spectrum function	17
2.2.3.2	Using Pointing function	19
3	Presentation	22
3.1	General	22
3.2	Description of the appliance	23
4	Power-up	25
4.1	Battery	25
4.2	Charging battery	25
4.3	External power supply	26
4.4	Turning the appliance on and off	26
5	Man-machine interface	27
5.1	Content of the screen	27
5.2	Changing a name or a value	29
5.2.1	Change inside a table	29
5.2.2	Change with selection	30
5.2.3	Change with virtual keyboard	30
5.3	Lists of measurements and setup library	31
6	Measurement lists	34
6.1	The List page	34
6.2	Modification of a list	35
7	Setup library	37
7.1	The Library page	37
7.2	Creation or modification of setups in the library	37
8	AUTOSET mode	40
8.1	Terrestrial mode	41
8.2	Satellite mode	41
8.3	Cable mode	42
8.4	«START »	42

9	Pointing antennas	44
9.1	Terrestrial antenna pointing	45
9.1.1	Updating channels	46
9.2	Satellite dish pointing	48
9.2.1	Updating satellites	50
9.2.2	Double Check Sat	51
9.2.3	Alignment of the satellite dish	51
9.2.4	Azimuth-Elevation-Polarization	52
10	The Measures-TV-Spectrum page	53
10.1	Modification of parameters	54
10.2	« AutoLock » function	54
10.3	Level measurements	55
10.3.1	Satellite band	55
10.3.2	Terrestrial band	56
10.4	C/N	57
10.5	Thresholds	58
10.6	Digital measurements	58
10.7	DVB-T/H	60
10.8	DVB-T2 / T2 Lite	61
10.9	DVB-C	62
10.10	J83B (MCNS)	63
10.11	DVB-C2	64
10.12	DVB-S and DSS	65
10.13	DVB-S2	66
10.13.1	Multistream	66
10.14	FM-RDS	68
10.15	DAB/DAB+	69
11	Spectrum analyser	70
11.1	Display modes	71
11.2	NIT/TV	73
12	Image and Sound	75
12.1	Digital TV	75
12.2	Audio	76
12.3	Table of services	76
12.4	PID function	76
12.5	NIT function	77
12.6	Record function PVR	77
12.7	ETR290 Alarms function	78
12.8	ETR290 Bitrates function	79
12.9	CAM installation / Access card	80
13	Monitoring	81
14	Remote power supply / LNB – DiSEqC	82
14.1	Terrestrial band	82
14.2	Satellite band	83

14.2.1	Launching.....	83
14.2.2	Switches.....	84
14.2.3	Positioner	85
14.2.4	DCSS	86
14.2.4.1	Influence of the DCSS on the spectrum analyzer.....	88
15	Measurement map.....	89
15.1	Measurements filtering	89
15.2	Periodic scan	89
15.3	USB recording	90
15.4	Values beyond tolerance	91
15.5	Graphics	91
16	Constellation	93
17	Echo / Guard interval.....	94
18	MER/Carrier	97
19	Shoulder Attenuation.....	98
20	ASI function.....	99
21	A/V function (external video)	100
22	GPS	101
22.1	VIEW function	101
22.2	LOG function.....	102
22.3	MAPPING function.....	102
22.3.1	Recording a file	104
22.3.2	Export and cartography.....	105
23	Optical Fiber function	107
23.1	What you should know.....	107
23.1.1	Optical fiber	107
23.1.2	Connectors.....	108
23.2	Satellite reception	109
23.3	Wavelengths	110
23.4	Optical Power measurement	111
24	5GHz input	112
25	WIFI	114
26	IPTV function.....	115
27	Save.....	116
28	Configuration	117
28.1	Language.....	117
28.2	Frequency map.....	117
28.3	Memories	117
28.3.1	View	118
28.3.2	Save	118
28.3.3	Save all	119
28.4	Adjustment.....	120

28.4.1	Measurement unit	120
28.4.2	Impedance	120
28.4.3	Bip	120
28.4.4	LCD	120
28.4.5	IP address	120
28.4.6	Password	121
28.4.7	Background	121
28.5	Configuration	122
28.6	Update	123
28.7	Factory recovery	123
29	Software update	124
30	Connection of the appliance to a PC.....	125
30.1	Required configuration	125
30.2	ETHERNET interface.....	125
30.3	Network connexion	126
31	HDMI Connection	127
32	Displayed messages.....	128
32.1	Alert messages	128
32.2	Error messages	129
33	Maintenance	130
34	Technical specifications.....	132
34.1	Selection Guide	132
34.2	Common technical specifications	133
34.3	Digital measurements	134
34.4	Divers.....	136
34.5	General specifications	137
34.6	Accessories	137
34.7	V, dB μ V, dBmV et dBm conversion.....	138
34.8	Typical values for measurements.....	138
35	CE Declaration	139

1 Important information

Please read carefully the following instructions before using your appliance.

1.1 Particular precautions

- Do not use the product for any other use than specified.
- Use the provided charger unit to prevent any deterioration of the appliance and guarantee its measurement characteristics.
- Do not use in a wet environment.
- Do not use in an explosive environment.
- In case of failure or for the maintenance of the appliance, only a qualified personal shall be entitled to work on it. In such a case, it is required to use SEFRAM spare parts.
- Do not open the appliance: risk of electric shock.
- You should use the F/F adaptor provided with your measuring instrument. Any other adaptor could damage your appliance and jeopardizes the guarantee.
- Do not use gloves, stylus or any other object on to the touchscreen. Handle the screen carefully.

1.2 Security instructions

For a correct use of the appliance, it is necessary that users abide by the security and use instructions described in this manual.

Symbols on the appliance:



Attention: Refer to the manual. Shows a risk of damage for the material connected to the instrument or to the instrument itself.



Ground: Grounded accessible parts.



Product for recycling.

1.3 Conformity and restrictions of the appliance

See chapter EC Declaration of conformity.

2 Quick start-up

2.1 Presentation of the appliance

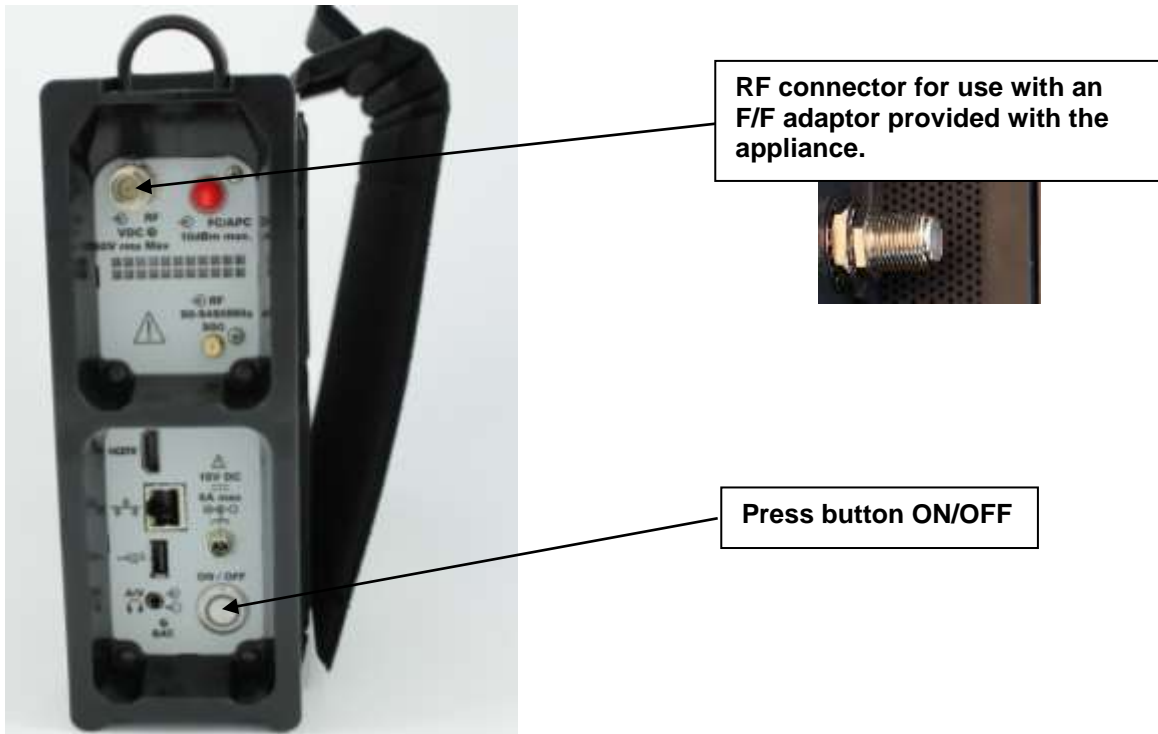

Important keys:

788X is an appliance with a capacitive touchscreen. This requires a soft handling. No glove and no stylus should be used, so that the triggering should be taken into account.

You will recognize the « keys » by their dark grey color.

Example the HOME key : 

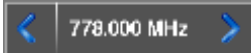

Some parameters can move 'step by step' : use arrows on each side of the value.

Frequency example : 

You may also access tables by pressing lines (on white or yellow)



Programme	
307	P1
300	P2
308	P3
310	P4
311	P5

	Attention: To exit a window like in this example below, press the key: 
---	---

Welcoming page:



- HOME**
Access to the main menu Home
- SAVE**
current page Save
- Measures-TV-Spectrum**
Access measurements

Home page :

The functions of the device are grouped by type: choose the category in this page by selecting a tab; the possible functions will then be accessible.



2.2 Signal spotting

The 788X allows spotting signals in terrestrial or satellite very quickly.

In the following chapter, we will see how to spot a signal on three types of installation:



- checking of a terrestrial antenna (the installation has already been made)
- installation of a terrestrial antenna
- installation of a satellite dish

2.2.1 Checking a terrestrial antenna

In this case, the “Autoset” function allows a “scan” of the channels that the antenna detects.

Plug the cable of your antenna to the 788X (take care to use an adequate adaptor)

Turn your appliance on.

Press the “Home” key , then choose the tab “RF” 

The Home page appears on screen. Press “Autoset”



On this page, press “Mode”, “Terrestrial”, then select DVB-T and 8MHz (as here below)

The scan should range from the E2 to the E69 channels, frequency range Europe (you may reduce the number of channels to scan if you know the range of the emitter where the antenna points at: the scan will be faster)



Press “START”, the appliance starts a search.

At the end of the scan, it turns directly to the “Measurement Plan” mode. If channels were found, the appliance makes measurements continuously (level, C/N1, BER/MER) on the detected channels.

freq	std	RF	C/N	BER _{ts}	BER _{ts}	PER	MER	LNB
E38	DVB-T/H	57.1	>42.0	2.3E-09	<2.4E-08	<2.4E-08	34.4	13.4
E44	DVB-T/H	57.8	>38.8	1.3E-08	<2.4E-08	<2.4E-08	32.7	12.7
E29	DVB-T/H	56.7	>36.4	1.4E-08	<2.3E-08	<2.3E-08	32.9	12.9
E40	DVB-T/H	58.7	>38.8	9.8E-09	<3.1E-08	<3.2E-08	33.0	12.0
E45	DVB-T/H	58.5	>40.0	6.1E-07	<2.4E-08	<2.4E-08	33.8	13.8
E49	DVB-T/H	58.3	>41.7	1.1E-08	<2.4E-08	<2.4E-08	32.8	11.8

Eventually, press the “Measures/TV/Spectrum” key; on this new page, select the channel that you want to display.

The instrument display on a single page of parameters of the signal, TV picture and Spectrum scan : a great time gain for your installs.



2.2.2 Installation of a terrestrial antenna

To install a terrestrial antenna, two ways are possible :

- Spectrum function use
- Pointing function use

2.2.2.1 Using Spectrum function

Plug the cable of your antenna to the 788X (take care to use an adequate adaptor)

Turn your appliance on. Press the “Measures-TV-Spectrum” key



Press the “Spectrum” area



Access to full SPAN mode

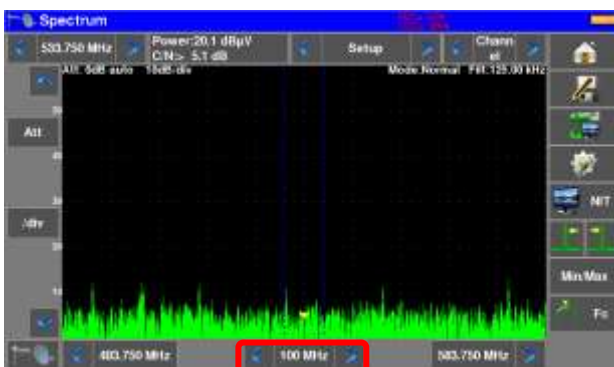

Adjust the antenna to get the most powerful signal possible

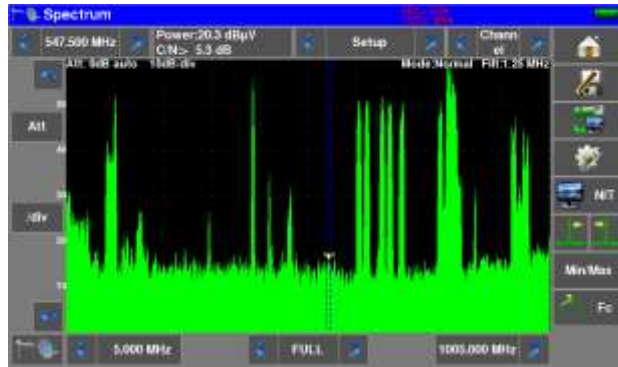

Press directly the signal you want in the spectrum (the cursor moves to where you press)

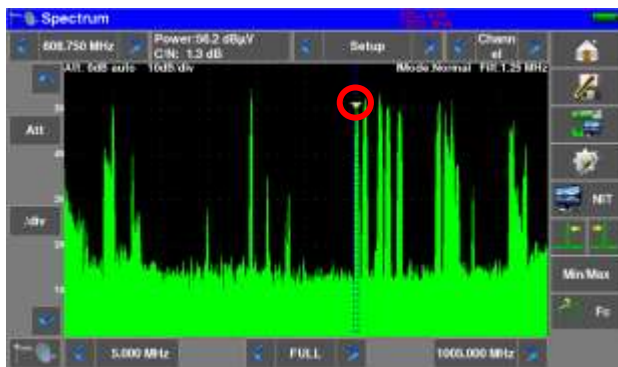

Press the NIT/TV key  , the device find automatically all the parameters of the signal.

Once the search ended, the device display TV picture, TV name, "Network Name" and "Network ID".

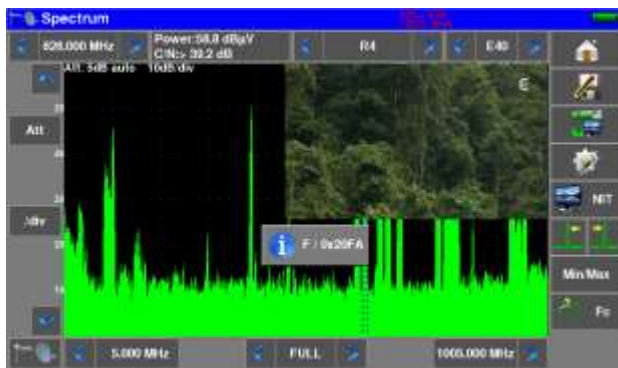

Press the "Measures-TV-Spectrum" key. You can now display the level, the BER/MER, the TV picture (with information about the current service) and the spectrum of the signal selected on the same page...



2.2.2.1 Using Pointing function

The device has a terrestrial pointing function to quickly and easily adjust your terrestrial antenna. Access the terrestrial pointing menu from the "HOME" page by pressing the key « Pointing »

 , puis « Terrestrial »

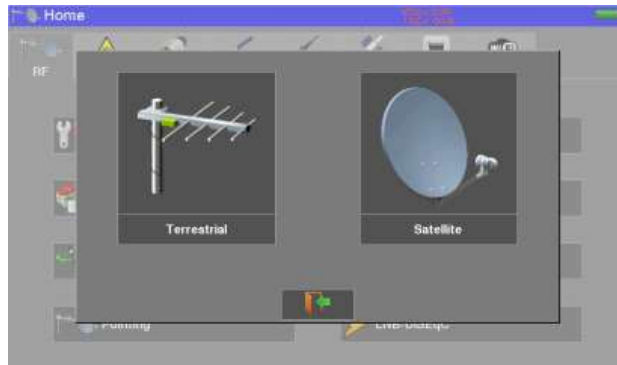

The following page appears :

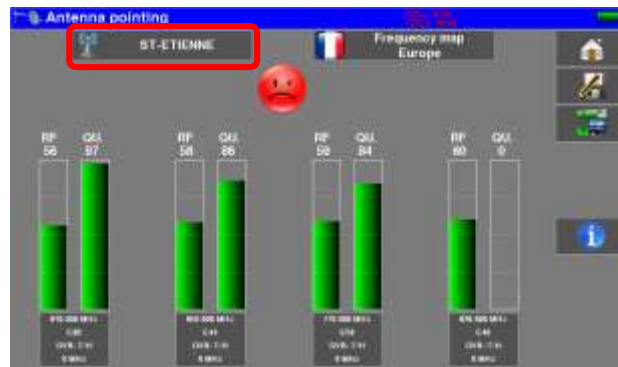

Choose the transmitter to point in the list

If your transmitter is not in the list, if you want to enter a new transmitter, please refer to chapter 9.1

Once you have completed the four channels, turn the antenna slowly until you hear the melody and get the maximum quality



No channels found → Red Smiley



Average reception quality → Orange smiley



Good reception quality → Green Smiley

2.2.3 Installation of a satellite dish

To install a satellite antenna, two ways are possible :

- Spectrum function use
- Pointing function use

2.2.3.1 Using Spectrum function

Connect the satellite dish to the appliance.

Activate the remote power supply

To access to the Remote power supply page, press “Home” and then “LNB-DISEQC”

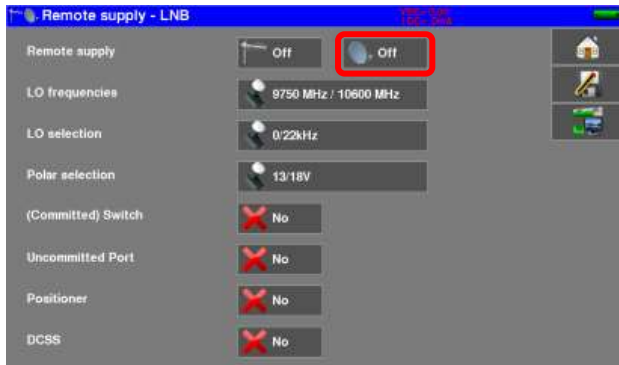

Press key « Measures-TV-Spectrum »



Press the “Spectrum” area (see below)

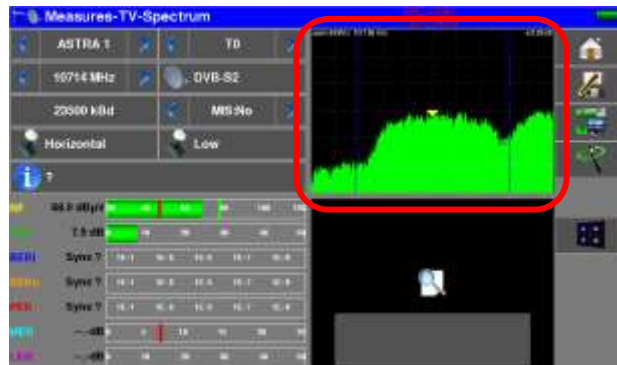

Access to full SPAN mode

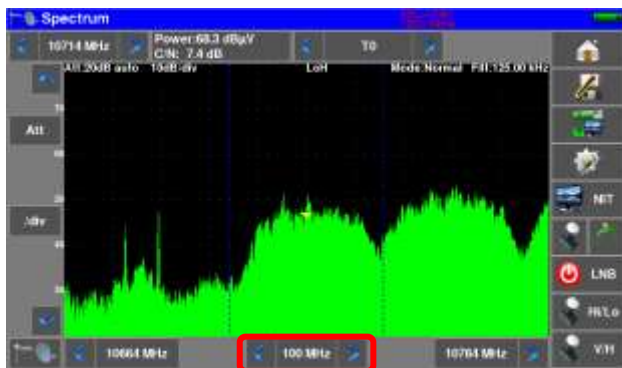

Adjust the antenna to get the most powerful signal possible

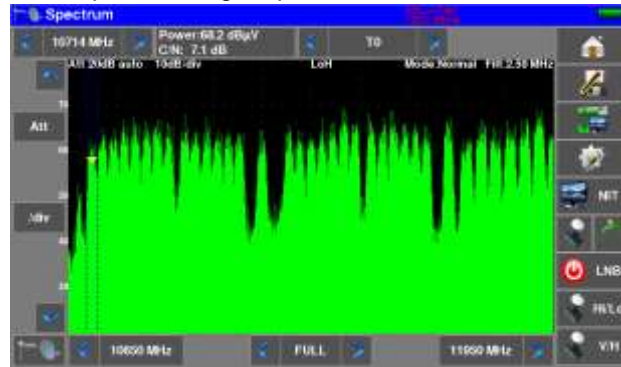

Press directly the signal you want in the spectrum (the cursor moves to where you press)

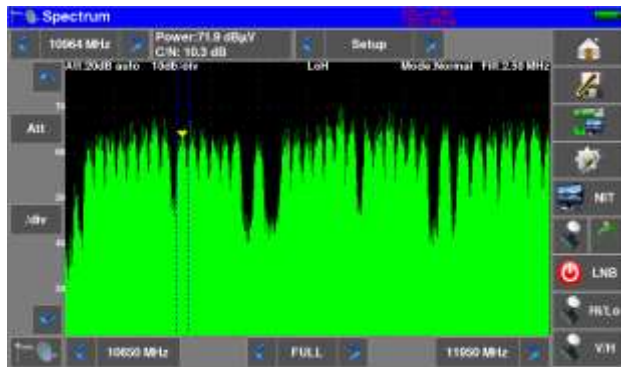

Press the NIT/TV key  , the device find automatically all the parameters of the signal.

Once the search ended, the device display TV picture, Satellite name, and “Network ID”.



Press the “Measures-TV-Spectrum” key. You can now display the level, the BER/MER, the TV picture (with information about the current service) and the spectrum of the signal selected on the same page...



2.2.3.2 Using Pointing function

The device has a satellite pointing function to quickly and easily adjust your dish.

Access the satellite pointing menu from the "HOME" page by pressing the key « Pointing » , then "Satellite".



The device proposes to activate the remote power supply :

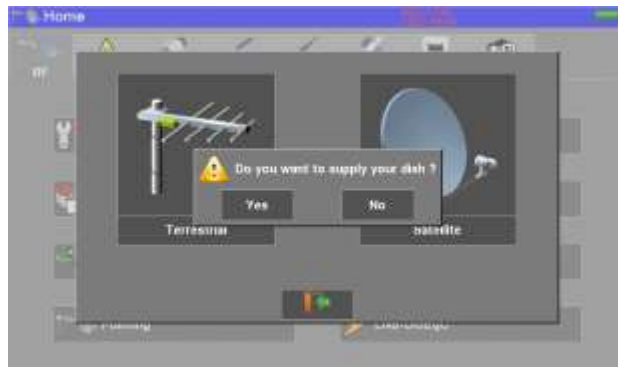

The following page appears:

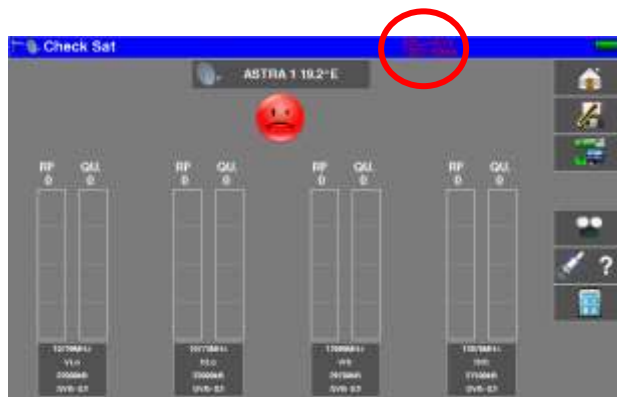

Check the indication of consumption on the remote power supply; zero consumption indicates a failed LNB, or a cut coaxial cable, for example.

Select a satellite like in the example below (here Astra1):

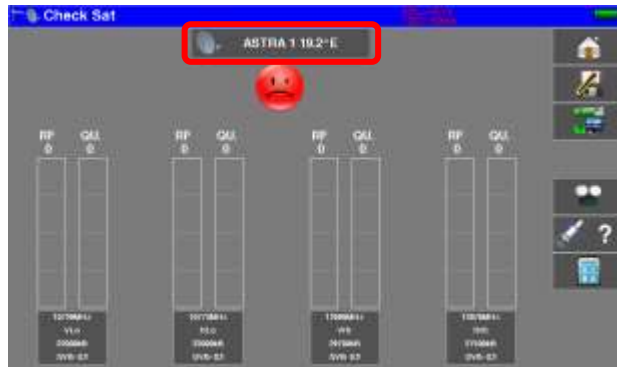

If your satellite is not in the list, if you want to enter a new satellite, refer to chapter 9.2.

Slowly orientate the satellite dish until hearing the locking melody and getting the best quality

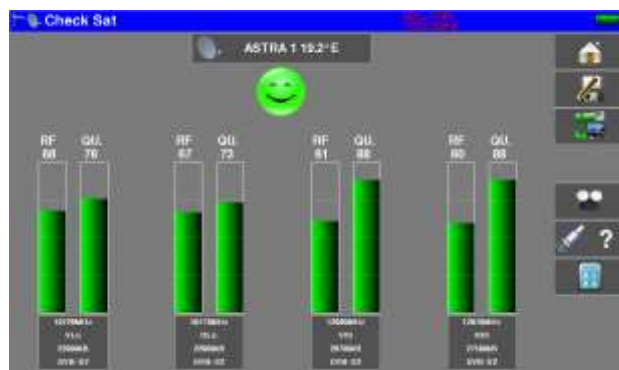

No found transponder → red smiley



Average reception quality → orange smiley



Good reception quality → green smiley

Reminder: transponder = satellite channel

To check if the aimed satellite is the right one: press the “NIT key” 

The appliance searches the MPEG NIT table on one of the 4 transponders and displays the name of the satellite:



Attention: The displayed name depends on the content of the MPEG NIT table.
Some distributors provide no (or poor) such table.
The displayed information may be wrong.



Attention:
To identify a satellite, you must be « hooked » on all 4 transponders. (Quality > 0)
However, some transponders are regularly modified. See the frequency range of the satellite when a transponder does not seem to work.
Some switches or LNB work only with DiSEqC commands. In this case, position the band (OL) and the polarization on DiSEqC at the Configuration page LNB-DiSEqC.
(Attention: the Check Sat is slower when using the DiSEqC command).

For any additional information, our technical support is at your disposal:

3 Presentation

3.1 General

The field strength measurers **788X** are handy appliances designed for the installation and maintenance of any broadcasting and reception installations of analogical and digital terrestrial television channels, satellites or cable networks.

The band ranges between **5 MHz to 2200 MHz**; this allows accurate measurements on all analogical television standards, FM carrier waves and the various digital standards DVB-C/C2, DVB-T/T2/T2Lite, DAB/DAB+, DVB-S/S2, DSS.

They do **Level** measurements in average, peak and power according to the selected standard.

In **Measurement Plan** mode, they scan up to 50 setups at the same time and compare them to decision levels (min / max).

Equipped with an efficient **Bit Error Rate** measurement (various BER, MER), they allow the full validation of digital transmissions DVB-T/T2/T2Lite, DVB-C/C2, DAB/DAB+, DVB-S/S2 and DSS.

Providing a **Constellation** diagram for digital standards, the detection and display of **Echoes and pre-echoes** and the display of **MER per carrier** in DVB-T/T2/T2Lite and DVB-C2 to have a complete analysis of the digital signals.

The **Spectrum** analysis, quick and accurate, allows the display of the disturbances and the measurement of C/N, power...

You can display the **digital TV terrestrial or satellite** under SD or HD, on standards **MPEG2, MPEG4, and HEVC**.

The visualization of the **terrestrial analog TV** image is also possible, in **RF** signal or **CVBS** video input.

The **Measures-TV-Spectrum** mode allows the simultaneous display of level, spectrum and of video of the same signal.

A **HDMI** socket allows the transmission of the TV picture to an external monitor.

The sound is audible through the built-in speakers, as well as available on the Jack headphone socket.

Designed for use on field, they are compact (less than 3 kg, battery included), autonomous (battery pack and quick charger), equipped with a LCD 10" touchscreen (capacitive).

The high memory content allows the storage of many configurations, measurements and spectrum curves.

Each appliance is fully remote-controlled through ETHERNET connection via a computer.

How to use the belts



Use of the sun visor



4 Power-up

All the material is checked before shipment and delivered in an adapted packaging. There is no particular unpacking instruction.

The appliance is equipped with a Lithium-Ion (Li-ion) battery. It is shipped with the battery loaded.

However, if the appliance has remained idle more than one month long, check its charge state and reload if required.

4.1 Battery



Attention: Any intervention on the battery requires the disassembly of the appliance and should be made by a SEFRAM technician.
Use only batteries provided by SEFRAM.

Security advice:

- Do not throw into the fire or heat up the battery pack
- Do not shunt the parts of the battery: risk of explosion!
- Do not drill
- Do not disassemble the battery pack
- Do not reverse the polarities of the battery
- This battery pack includes a protective item that should not be damaged or removed
- Protect the pack from the heat while storing
- Do not damage the protective sheath of the pack
- Do not store the appliance in a vehicle under sunlight
- Used batteries are not for domestic waste; lithium batteries should be recycled.

The battery has a 200-charge-discharge cycle life or 2 years.

Advice to extend the life of your battery:

- Avoid deep discharges
- Do not store the batteries too long without using them
- Store the battery around 40% loading
- Do not fully charge or fully discharge the battery before storage.

When the battery is almost fully discharged, the appliance will warn “Low battery”, then will shut off after a few minutes.

4.2 Charging battery

To charge the battery inside the appliance:

- Connect the external power supply provided through the jack plug of the appliance (on the right side)
- Connect the power supply on the mains
- The internal charger starts charging the battery; the green lamp lights up.



Loading will be faster if the **appliance is off** but will work if the appliance is on. Once the battery loaded, the lamp will shut off automatically.
Discharge the appliance only with the provided power supply block.

The battery is 80%-loaded after 1 hour 50 minutes.

The total charge is reached after 2 hours 40 minutes.

The autonomy is set in terrestrial mode at 50% brightness, without remote power supply, interfaces not connected, sound at 10%

4.3 External power supply

The appliance works under 15V (4.6 A) power supply.

The power supply block provided is an external power supply too.

Only use the power supply block provided with the appliance.



Using another power supply could damage your device and void the warranty.

4.4 Turning the appliance on and off

Press the button on the right side of the appliance:



The entry page appears on screen.

The message “**Autotest: running**” is shortly displayed, then disappears.



Pressing this button turns the appliance off.



The ON/OFF button **lights up** when the appliance is working.
Pressing the ON/OFF button for a long time **forces the shut-off** of the appliance;
proceed this way only in case of necessity.

5 Man-machine interface

5.1 Content of the screen

788X is an appliance with a capacitive touchscreen. This requires a soft handling. No glove and no stylus should be used, so that the triggering should be taken into account.

You will recognize the « keys » by their dark grey color.

Exemple the home key:



Certains paramètres sont modifiables par pas : utiliser les flèches de chaque côté de la valeur.

Exemple de la fréquence :



You can also select lines in tables.

Programme		
307	P1	▲
308	H2	
309	P3	
310	P4	

Presentation page :



Home

Access to the main menu page

Save

Access to the save of the current page

Measures-TV-Spectrum

Access to the Measures/TV/Spectrum page

Windows :



Attention: To display a window like this one below, you have to press the key 











Home page :

The functions of the device are grouped by type: choose the category in this page by selecting a tab; the possible functions will then be accessible.



"Home" page allows the navigation through all functions of the appliance.

We find the categories related to the **measurement input used**:

-  RF access to measurements on the RF input socket (levels, BER / MER, spectrum, TV, ...)
-  Optical access to measurements on the Fiber Optic input (power, demodulation, ...)
-  5 GHz access to measurements on RF input 5GHz (levels, BER / MER, spectrum, TV, ...)
-  ASI access to measurements on the input ASI (TV, ETR290, ...)
-  A/V access to the measurements on the Audio / Video input (TV, ...)
-  GPS access to GPS-related measurements (cartography, reception, ...)
-  IPTV access to measurements on the IPTV Ethernet input (IAT, TV, ...)
-  Wi-Fi access to measurements on the Wi-Fi input (levels, SSID, ...)

Informations :

On all pages is displayed the following informations :

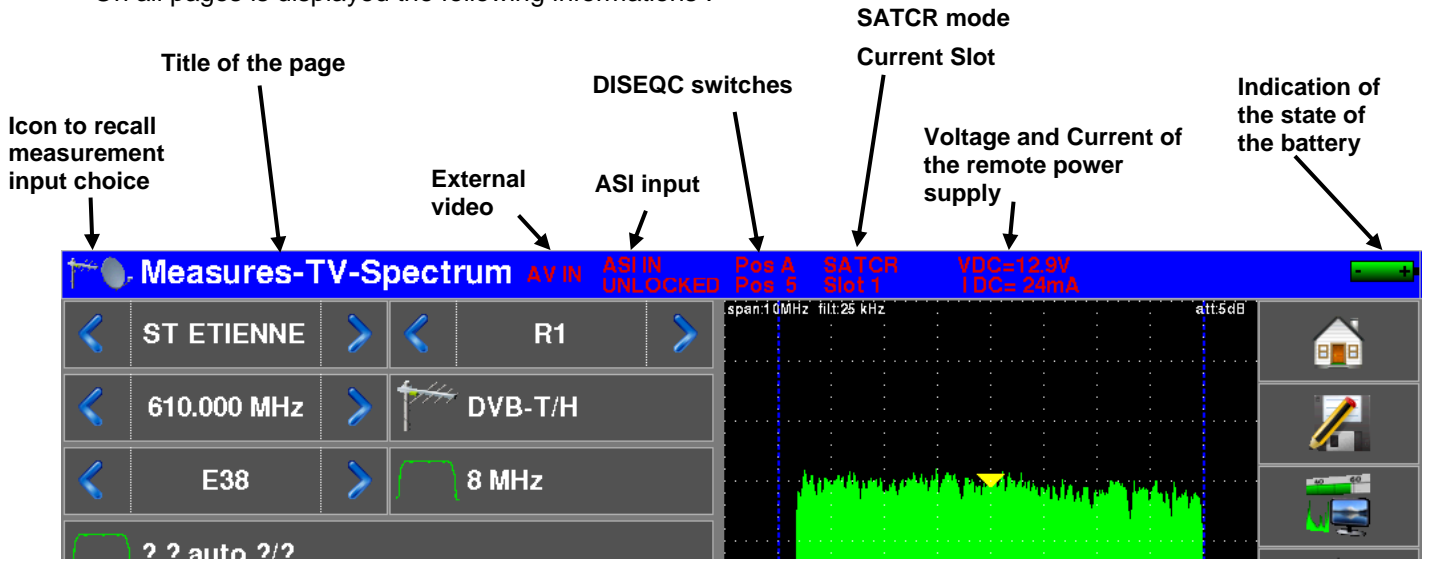

5.2 Changing a name or a value

5.2.1 Change inside a table

You can select a setup in the table. In this case, you can validate a setup by pressing the line you want to display

In this example, you change from the TNT-R1 setup to the TNT-R4 in the Measure page:

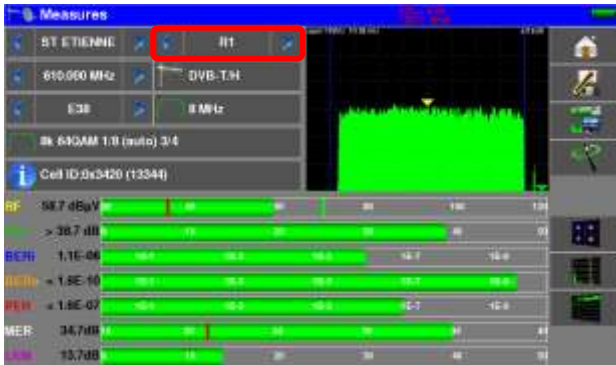

5.2.2 Change with selection

When pressing a key, you may have a window with multiple choice. You only have to press the value you want to validate it. The  key allows you to cancel and exit this window, like in the example below. In this example, the bandwidth changes from 6 to 8 MHz:

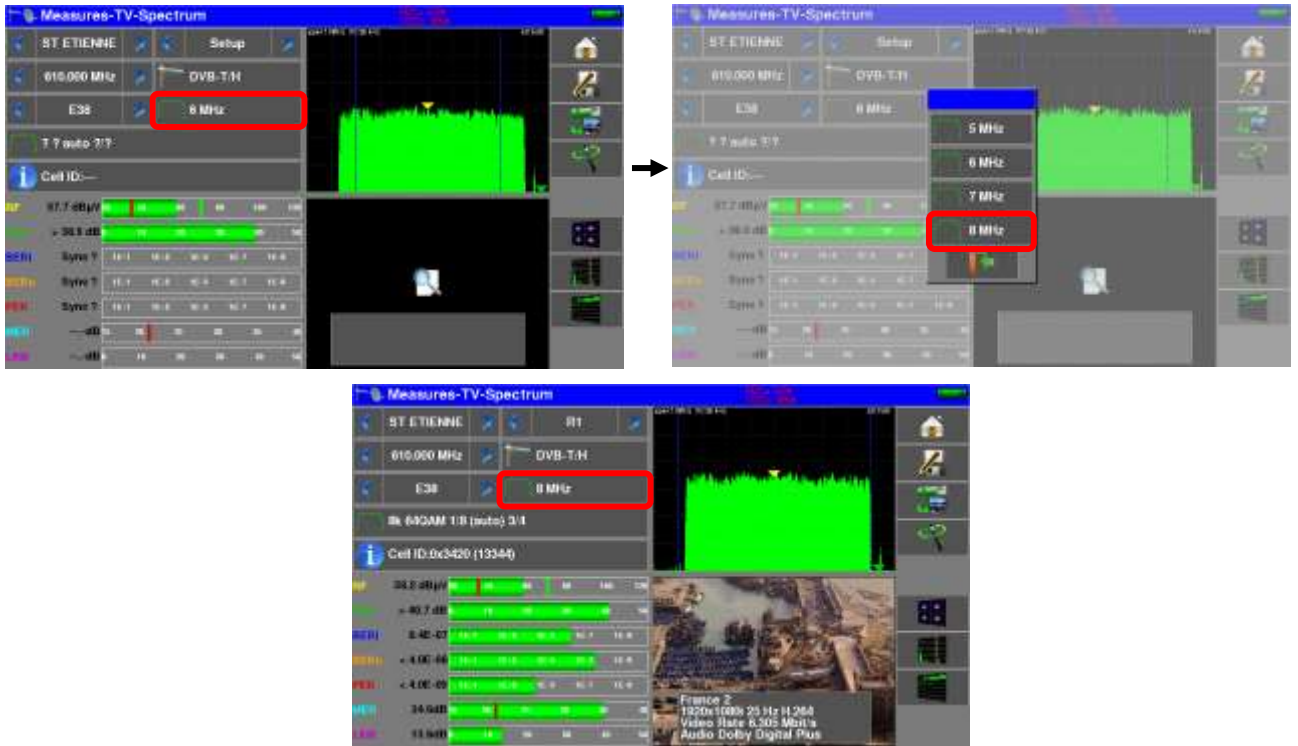

5.2.3 Change with virtual keyboard

If you want to enter a name of a number, press on the “keyboard” symbol on the line you want to change :



or on the numeric value you want to change :



5.3 Lists of measurements and setup library

In order to make easier the recall of data on field, the appliance uses **20 Measurement Lists** of each 50 lines and a **Library** of 1000 setups.

A setup corresponds to a terrestrial, cable or satellite emission.

A list of measurements corresponds to a particular installation: presence of several satellite dishes, of various switches...

Example of list (the background of the table is white)

#	name	freq	standard	config
307	R1 ST-ETIENNE	E38	DVB-T-H 8M GI auto	---
308	R2 ST-ETIENNE	E44	DVB-T-H 8M GI auto	---
309	R3 ST-ETIENNE	E58	DVB-T-H 8M GI auto	---
310	R4 ST-ETIENNE	E40	DVB-T-H 8M GI auto	---
311	R5 ST-ETIENNE	E46	DVB-T-H 8M GI auto	---
312	R7 ST-ETIENNE	E48	DVB-T-H 8M GI auto	---
---	---	---	---	---
---	---	---	---	---
---	---	---	---	---
---	---	---	---	---

Example of library (the background of the table is yellow)

#	name	freq	standard
0	T0 19.2E	10714 HL	DVB-S2 23900
1	T1 19.2E	10720 VL	DVB-S2 22000
2	T2 19.2E	10740 HL	DVB-S 22000
3	T3 19.2E	10750 VL	DVB-S 22000
4	T4 19.2E	10770 HL	DVB-S2 22000
5	T5 19.2E	10780 VL	DVB-S 22000
6	T6 19.2E	10800 HL	DVB-S2 22000
7	T7 19.2E	10817 VL	DVB-S2 22000
8	T8 19.2E	10832 HL	DVB-S2 22000
9	T9 19.2E	10847 VL	DVB-S 22000

The same setup may be used in several measurement lists.

The same installation may use two satellite dishes

ASTRA 19.2 in DiSEqC position A

HOT BIRD 13 in DiSEqC position B

Another one may use three satellite dishes

ATLANTIC BIRD 3 in DiSEqC position A

ASTRA 1 in DiSEqC position B

HOT BIRD in DiSEqC position C

The same setup may be used several times in the same measurement list.

ZDF SatCR slot 0

ZDF SatCR slot 1

ZDF SatCR slot 2

ZDF SatCR slot 3...

If a parameter of a setup changes, for example a modification of rate or change from DVB-S to DVB-S2, only the setup inside the library should be updated.



These lists and setups may be created on a computer thanks to TR7837 free software, and loaded to the appliance through a USB stick.

A list of measurements is made of:

- a list name in 10 characters
- the lowest frequency of the LNB (OL1)
- the highest frequency of the LNB (OL2)
- the selection mode low band / high band of the LNB
- the selection mode of the polarization
- the presence of the position number of the positioner (motorized satellite dish)
- 50 lines including each:
 - a setup number corresponding to the setup list
 - the presence and the functioning mode of the switch, committed type
 - the position of the switch, committed type
 - the presence and the functioning mode of the switch, uncommitted type
 - the position of the switch, uncommitted type
 - the presence of SatCR equipment
 - the SatCR slot number
 - the position of the SatCR switch

A few of these parameters are specific to the waveband of the satellite and have no influence in terrestrial and cable modes.

Presentation of a measurement list in TR7837 :

A	B	C	D	E	F	G	H	I
Nom de la liste / List name	ASTRA1+HOT							
Fréquence OL1 / LO1 frequency	9750							
Fréquence OL2 / LO2 frequency	10600							
Sélection OL / LO setup	DSEqC							
Sélection polarisation / Polarization setup	DSEqC							
Positionneur / Positioner								
	Numéro de programme Setup number	Switch committed Committed switch	Position Switch committed Committed switch position	Switch uncommitted Uncommitted switch	Position switch uncommitted Uncommitted switch position	Activation SatCR SatCR enabled	Numéro de slot Slot number	Switch SatCR SatCR switch
0								
1	1	DSEqC	Pos A					
2	2	DSEqC	Pos A					
3	3	DSEqC	Pos A					
4	4	DSEqC	Pos A					
5	5	DSEqC	Pos A					
6	6	DSEqC	Pos A					
7	7	DSEqC	Pos A					
8	8	DSEqC	Pos A					
9	9	DSEqC	Pos A					
10	10	DSEqC	Pos A					
11	11	DSEqC	Pos A					
12								
13	18	DSEqC	Pos B					
14	19	DSEqC	Pos B					
15	20	DSEqC	Pos B					
16	21	DSEqC	Pos B					
17	22	DSEqC	Pos B					
18	23	DSEqC	Pos B					
19	24	DSEqC	Pos B					
20	25	DSEqC	Pos B					

A setup is made of:

- a setup name in 8 characters
- a place name in 10 characters
- a frequency
- a channel number in terrestrial or cable mode
- a frequency map in terrestrial or cable mode
- a vertical or horizontal polarization in satellite mode
- a low or high LNB band in satellite mode
- a standard

- an analogical mono stereo or NICAM mode in terrestrial or cable mode
- a constellation type 64QAM 256QAM under DVB-C and J83B
- a bandwidth 5, 6, 7 or 8 MHz under DVB-T and DVB-T2
- a symbol rate under DVB-C, J83B, DVB-S, DVB-S2 or DSS
- a value for the guard interval under DVB-T and DVB-T2
- the inversion or not of the spectrum under DVB-T

According to the terrestrial, cable or satellite band mode and to the standard, some parameters have no influence.

The place name may distinguish two distinct emitters, example TF1 Fourvière and TF1 Chambéry.

Frequency and channel number are equivalent: a valid channel number has priority over a frequency.

The frequency map parameter associated with the setup allows frontiersmen to keep on using channel numbers.



Selecting a list in the **Lists** page automatically recalls all information associated with this list.



Selecting a **Setup** on a measurement page automatically recalls all information associated with this setup.

Presentation of a setup library in TR7837 :

A	B	C	D	E	F	G	H	I	J	K	L	M	N	O
	Nom du programme Setup name	Nom du site Place name	Fréquence Frequency	N° de canal Channel #	Plan de fréquence Frequency map	Polarisation Polarization	Bande LNB LNB band	Standard	Mode audio Audio mode	Coexistence	Largeur de bande Bandwidth	Débit symbole Symbol rate	Intervalle de garde Guard interval	Inversion de spectre Spectrum inversion
2	0	DIGITAL+	ASTRA 1	10729 000		V		DVB-S2				22000		
3	1	ARD	ASTRA 1	10743 000		H		DVB-S				22000		
4	2	SKY D	ASTRA 1	10773 000		H		DVB-S2				22000		
5	3	DIGITAL+	ASTRA 1	10788 000		V		DVB-S				22000		
6	4	DIGITAL+	ASTRA 1	10817 000		V		DVB-S2				22000		
7	5	ANIXE HD	ASTRA 1	10832 000		H		DVB-S2				22000		
8	6	DIGITAL+	ASTRA 1	10847 000		V		DVB-S				22000		
9	7	TVP HD	ASTRA 1	10861 000		H		DVB-S				22000		
10	8	DIGITAL+	ASTRA 1	10876 000		V		DVB-S				22000		
11	9	UPC	ASTRA 1	10920 000		H		DVB-S				22000		
12	10	DIGITAL+	ASTRA 1	10979 000		V		DVB-S				22000		
13	11	SKY D	ASTRA 1	11023 000		H		DVB-S2				22000		
14	12	DIGITAL+	ASTRA 1	11038 000		V		DVB-S				22000		
15	13	DIGITAL+	ASTRA 1	11097 000		V		DVB-S				22000		
16	14	DIGITAL+	ASTRA 1	11156 000		V		DVB-S				22000		
17	15	ORANGE	ASTRA 1	11170 000		H		DVB-S2				22000		
18	16	ORF	ASTRA 1	11302 000		H		DVB-S2				22000		
19	17	DIGITAL+	ASTRA 1	11317 000		V		DVB-S				22000		
20	18	DASERSTE	ASTRA 1	11361 000		H		DVB-S2				22000		
21	19	DIGITAL+	ASTRA 1	11435 000		V		DVB-S2				22000		
22	20	HD+	ASTRA 1	11464 000		H		DVB-S2				22000		
23	21	CANALSAT	ASTRA 1	11479 000		V		DVB-S				22000		
24	22	GLOBECAS	ASTRA 1	11508 000		V		DVB-S				22000		
25	23	GLOBECAS	ASTRA 1	11538 000		V		DVB-S				22000		
26	24	CANALSAT	ASTRA 1	11567 000		V		DVB-S2				22000		
27	25	ASTRA	ASTRA 1	11597 000		V		DVB-S				22000		
28	26	DIGITAL+	ASTRA 1	11626 000		V		DVB-S2				22000		
29	27	UPC	ASTRA 1	11670 000		H		DVB-S				22000		
30	28	DIGITAL+	ASTRA 1	11685 000		V		DVB-S				22000		
31	29	SKY D	ASTRA 1	11719 000		H		DVB-S				27500		
32	30	VIACOM	ASTRA 1	11739 000		V		DVB-S				27500		
33	31	SKY D	ASTRA 1	11758 000		H		DVB-S				27500		
34	32	CANALSAT	ASTRA 1	11778 000		V		DVB-S				27500		
35	33	SKY D	ASTRA 1	11797 000		H		DVB-S				27500		
36	34	CANALSAT	ASTRA 1	11817 000		V		DVB-S				27500		
37	35	ARD	ASTRA 1	11836 000		H		DVB-S				27500		
38	36	CANALSAT	ASTRA 1	11856 000		V		DVB-S				27500		
39	37	SKY D	ASTRA 1	11875 000		H		DVB-S				27500		
40	38	CANALSAT	ASTRA 1	11895 000		V		DVB-S				27500		
41	39	SKY D	ASTRA 1	11914 000		H		DVB-S2				27500		
42	40	CANALSAT	ASTRA 1	11934 000		V		DVB-S				27500		

6 Measurement lists

6.1 The List page

In this page, you can select the list where you will work on measurements.

Pressing Home Lists function:



then Lists-Library



gives you access to the

#	name	freq.	standard	config
307	R1 ST-ETIENNE	E36	DVB-T/H 8M GI auto	---
308	R2 ST-ETIENNE	E44	DVB-T/H 8M GI auto	---
309	R3 ST-ETIENNE	E55	DVB-T/H 8M GI auto	---
310	R4 ST-ETIENNE	E40	DVB-T/H 8M GI auto	---
311	R6 ST-ETIENNE	E46	DVB-T/H 8M GI auto	---
312	R7 ST-ETIENNE	E48	DVB-T/H 8M GI auto	---
---	---	---	---	---
---	---	---	---	---
---	---	---	---	---
---	---	---	---	---

Lists are ranked from 0 to 19. To select the list you want, press the following the name of the list. Available Lists are displayed. Press the one you want:

#	name	freq.	standard	config
0	ASTRA 1			
1	HOTBIRD			
2	EUTELSAT			
3	ASTRA 3			
4	ASTRA 2			
5	TURKSAT			
6	ST ETIENNE			
7				
8				
9				
10				

In this example, we selected ST ETIENNE.

#	name	freq.	standard	config
0	ASTRA 1			
1	HOTBIRD			
2	EUTELSAT			
3	ASTRA 3			
4	ASTRA 2			
5	TURKSAT			
6	ST ETIENNE			
7				
8				
9				
10				



#	name	freq.	standard	config
307	R1 ST-ETIENNE	E36	DVB-T/H 8M GI auto	---
308	R2 ST-ETIENNE	E44	DVB-T/H 8M GI auto	---
309	R3 ST-ETIENNE	E55	DVB-T/H 8M GI auto	---
310	R4 ST-ETIENNE	E40	DVB-T/H 8M GI auto	---
311	R6 ST-ETIENNE	E46	DVB-T/H 8M GI auto	---
312	R7 ST-ETIENNE	E48	DVB-T/H 8M GI auto	---
---	---	---	---	---
---	---	---	---	---
---	---	---	---	---
---	---	---	---	---



Attention: A list may contain both Satellite and Terrestrial setups.

6.2 Modification of a list

To change the name of a list, you must trigger its name.

A virtual keypad shows up, type the new name.

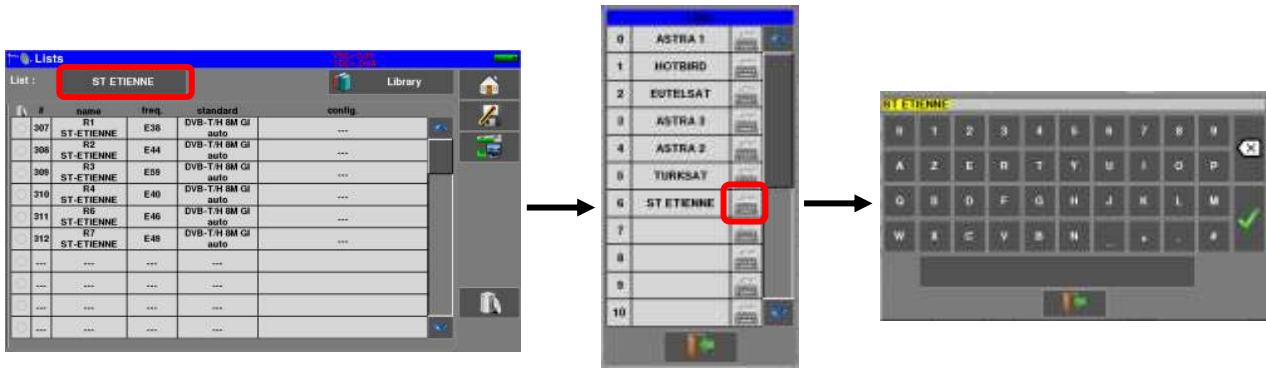

To add a setup to the list, select the line. A window shows up:

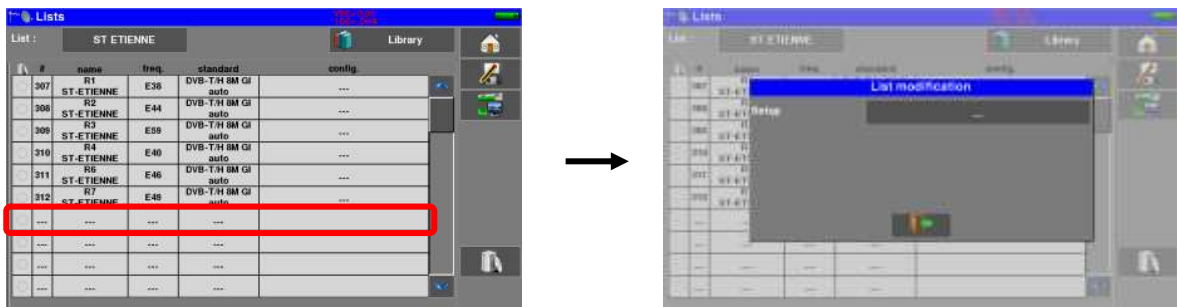



Attention: If the line contains a setup, it shall be erased. To cancel, press: 

By pressing the key before Setup, you disclose the available setups from the library (you cannot create a setup from a list; to create a setup, see [Setup creation or modification in the library](#)):

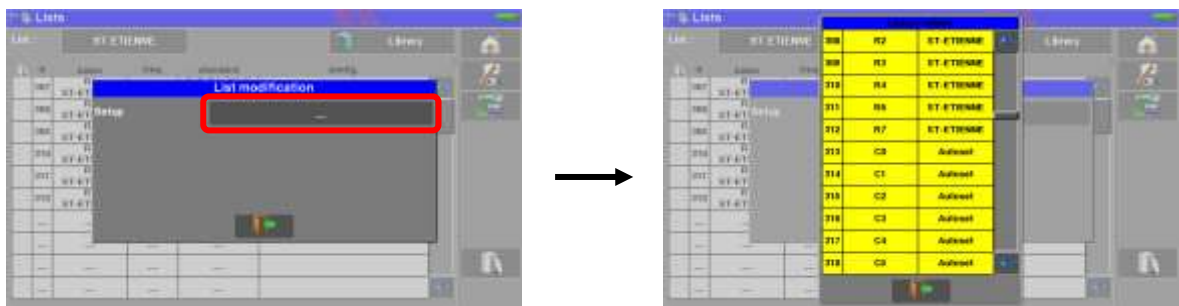

Scroll the list up or down to find the setup you want to add to your list. Press the line you want:



The setup is now in the list:

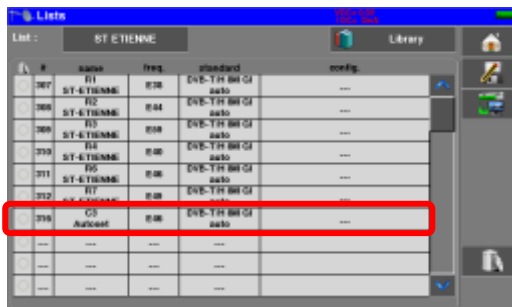

You may erase one or all setup(s) from the list :
mark on the left all lines to be deleted:

Then simply press the trash  and validate your choice:

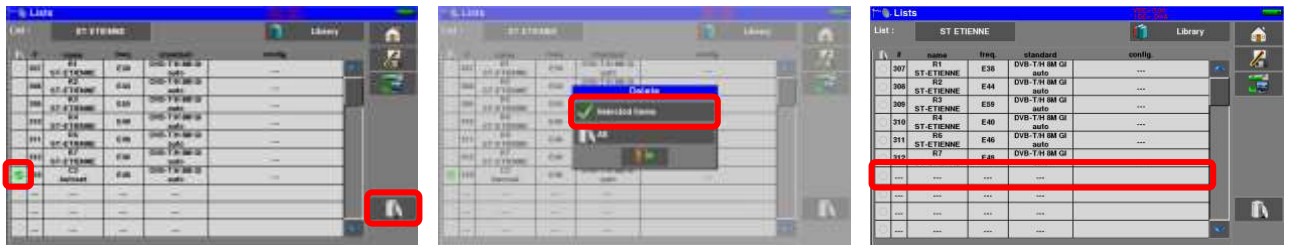

In a satellite setup, you can change the Switch, the Uncommitted Port and the DCSS by activating any of these keys (this change will affect only the setup in this list, not in the library):

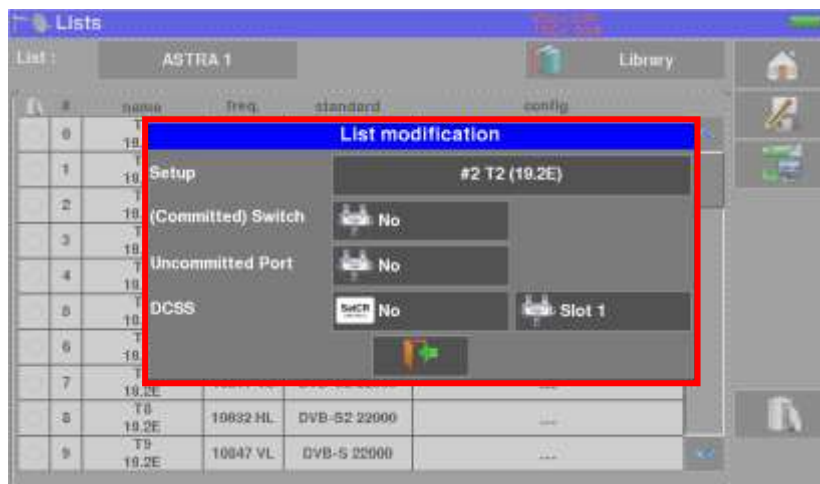

7 Setup library

7.1 The Library page



By pressing Home  then Lists-Library , you can access the Lists function. From there, you can access the Library by pressing the key: 



#	name	freq.	standard
307	R1 ST-ETIENNE	E38	DVB-T/H 8M GI auto
308	R2 ST-ETIENNE	E44	DVB-T/H 8M GI auto
309	R3 ST-ETIENNE	E59	DVB-T/H 8M GI auto
310	R4 ST-ETIENNE	E40	DVB-T/H 8M GI auto
311	R6 ST-ETIENNE	E46	DVB-T/H 8M GI auto
312	R7 ST-ETIENNE	E49	DVB-T/H 8M GI auto
313	C0 Autoset	E38	DVB-T/H 8M GI auto
314	C1 Autoset	E40	DVB-T/H 8M GI auto
315	C2 Autoset	E44	DVB-T/H 8M GI auto
316	C3 Autoset	E46	DVB-T/H 8M GI auto

7.2 Creation or modification of setups in the library

To create or change a setup in the library, you have to select a line in the table. A window pops up:

 **Attention:** If the line contains a setup, it will be erased. To cancel, press: 



#	name	freq.	standard
314	C1 Autoset	E46	DVB-T/H 8M GI auto
315	C2 Autoset	E44	DVB-T/H 8M GI auto
316	C3 Autoset	E46	DVB-T/H 8M GI auto
317	C4 Autoset	E48	DVB-T/H 8M GI auto
318	C4 Autoset	E59	DVB-T/H 8M GI auto
319	---	---	---
320	---	---	---
321	---	---	---
322	---	---	---
323	---	---	---

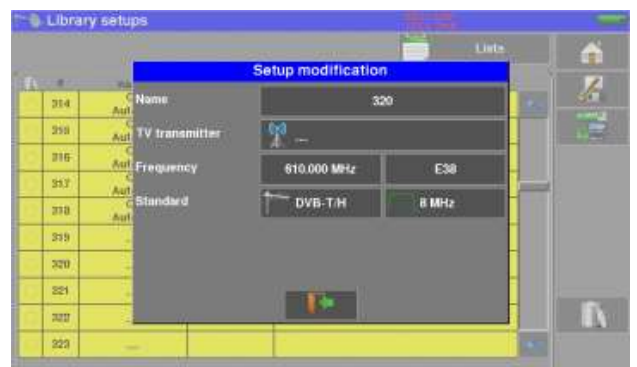

Setup modification

Name: 320

TV transmitter: 

Frequency: 610.000 MHz | E38

Standard: DVB-T/H | 8 MHz



From this window, you can create a terrestrial, satellite KU, L or C setup.

First choose the Standard of the program you want to create; you will then have access to parameters related to the standard.

To proceed, see chapter “ [Man-machine interface](#) “

➤ **Terrestrial setup:**

Under standard DVB-T/H (DVB-T2 identical, except modulation)

To enter the name you want for the setup

To enter the frequency you want for the setup

To enter the standard you want for the setup (DVB-T/H in this case)

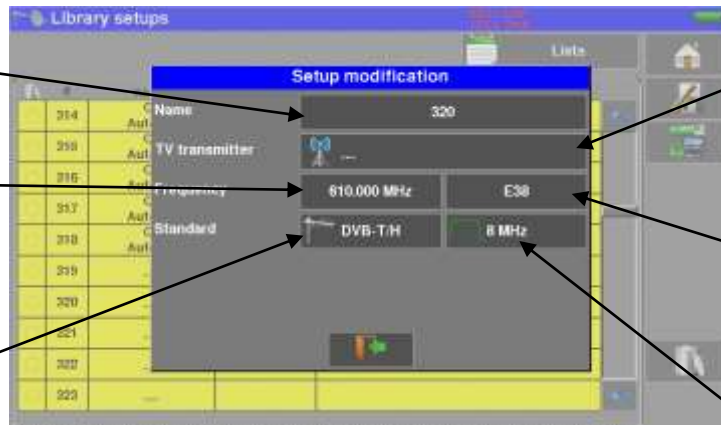

To enter the place name you want for the setup

To enter the channel you want for the setup

To enter the frequency band you want for the setup

Under standard DVB-C

To enter the symbol rate you want for the setup

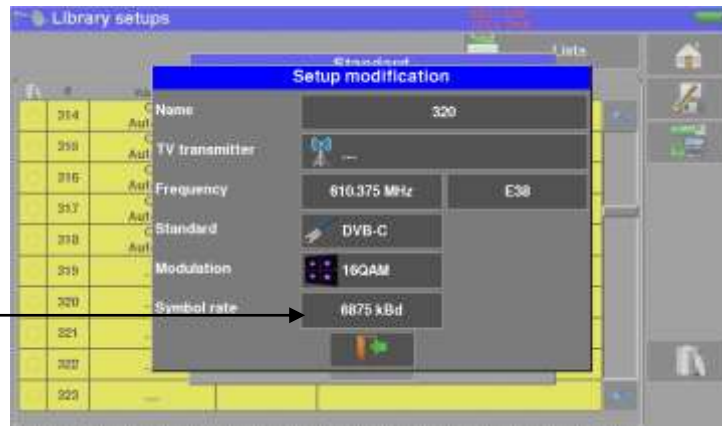

In terrestrial analogical standard (L, BG, DK, I and MN)

To enter the type of audio configuration you want for the setup (mono, stereo or NICAM)

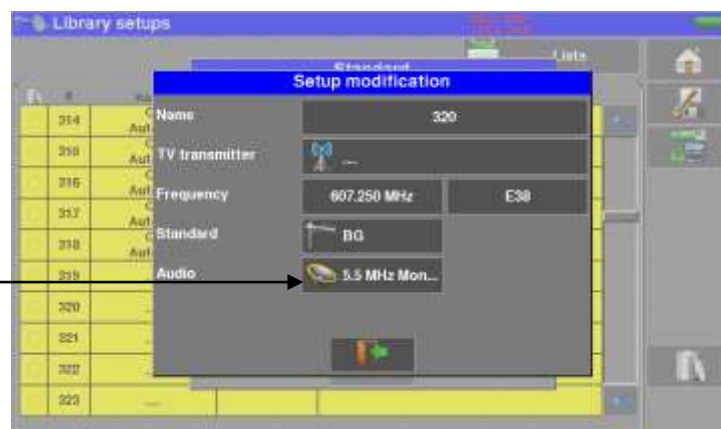

➤ **Setup Satellite KU, L or C:**

Ku, L, or C corresponds to the satellite band of the setup

To enter the type of polarity you want for the setup (high or low, vertical or horizontal)

To enter the symbol rate you want for the setup

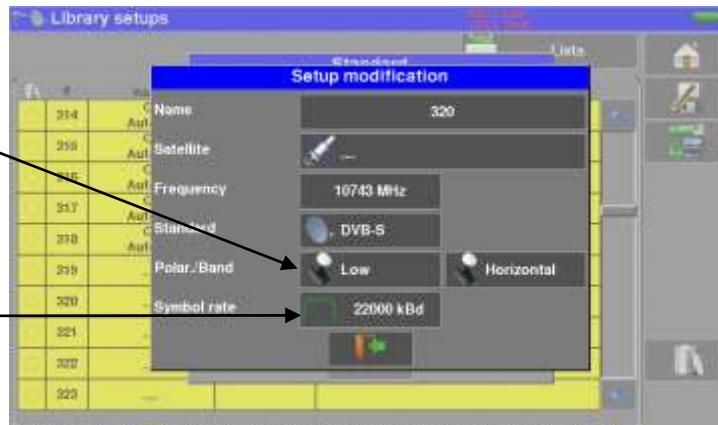

8 AUTOSSET mode

 **Attention:** The Autoset channel research is only possible when at least one list is empty with enough place in the library

This mode allows an **automatic research of setups** and to provide information about the current place. You can access it through the key  on page "Home".

The displayed lines on this page depend on the selected **Frequency band** : terrestrial, cable or satellite mode:



Once the mode selected, the keys of the various parameters activate or deactivate each option.

A green check shows that the parameter is included in the research. If there is no green check, the parameter will not be taken into account for the research.

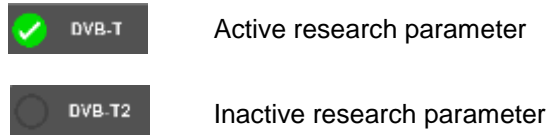

	Attention: The more you select options, the longer the research.
---	---

8.1 Terrestrial mode

This mode allows automatic research on the **terrestrial** frequency band.

The table allows the selection of:

- Standards
- Channel widths
- The channel range of the research (i.e. 21 to 58).

Reducing the number of active parameters reduces the search time.



8.2 Satellite mode

This mode allows automatic research on the **satellite** frequency band.

The table allows the selection of:

- Standards
- LNB bands
- LNB polarizations.



8.3 Cable mode

This mode allows automatic research on the **cable** frequency band.

The table allows the selection of:

- Standards
- Channel widths
- The channel range of the research (i.e. 21 to 58).



8.4 «START »

No matter which mode is selected, press the “**START**” key when the table is filled to launch the research.

Pressing “**Stop**” will abort the research.

When the research is done, the appliance turns automatically to the **Measurement map** function.

The screenshot shows the 'Measurement map' screen with a table of results. The table has columns for 'freq.', 'std', 'RF', 'C/N', 'BER1', 'BER0', 'PER', 'MER', and 'LKM'. The first six rows contain data for frequencies E38, E40, E44, E46, E49, and E59, all using the DVB-T/H standard. The table is part of an 'AUTOSET' mode, as indicated by the header and a progress bar showing '1/6 -> 0 min'. On the right side, there are buttons for 'Measure', 'Mode', and other navigation icons.

freq.	std	RF	C/N	BER1	BER0	PER	MER	LKM
E38	DVB-T/H	59.8	>39.8	1.1E-06	<3.1E-06	<3.2E-05	35.1	14.1
E40	DVB-T/H	61.2	>41.2	1.5E-05	<2.3E-06	<2.3E-05	33.4	12.4
E44	DVB-T/H	61.1	>41.1	7.6E-08	<2.4E-06	<2.4E-05	34.7	13.7
E46	DVB-T/H	60.7	>40.7	3.8E-07	<2.4E-06	<2.4E-05	32.6	11.6
E49	DVB-T/H	56.2	>36.2	<7.3E-06	<2.3E-06	<2.3E-05	32.6	11.6
E59	DVB-T/H	58.8	>38.8	<7.3E-06	<2.3E-06	<2.3E-05	33.9	12.9

Any detected channel will be registered into the first empty list (automatically renamed AUTOSET) and into the first available setups of the library, starting from the end of the table.

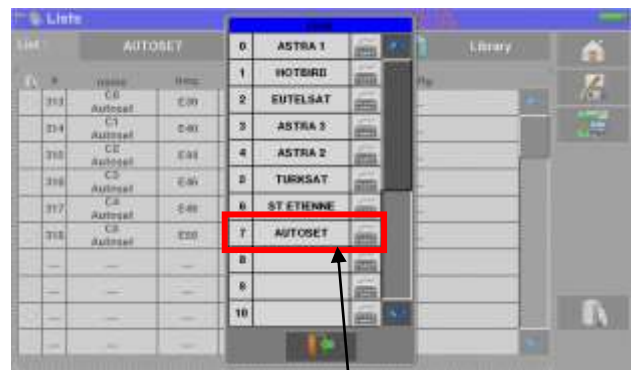
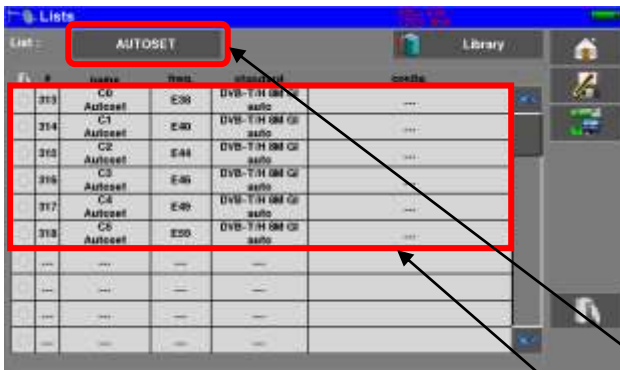

The new list is created in the first available list

The default name of the new list is AUTOSET

New found channels are added one by one into the new list

New found channels are added one by one into the first available setups of the library, starting from the end of the table

9 Pointing antennas

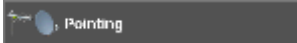
Press  and  to access the Pointing Antennas mode.

Then choose the antenna to point: terrestrial or satellite dish

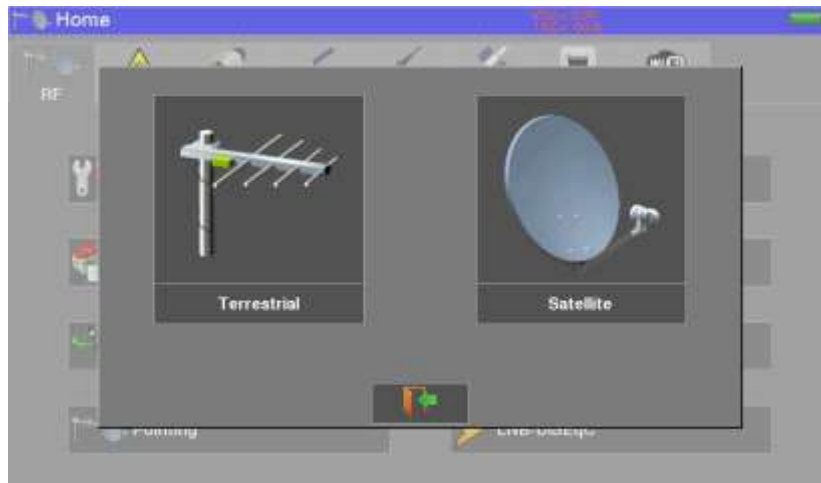

In the case of the satellite dish, the device offers you to supply now your dish:

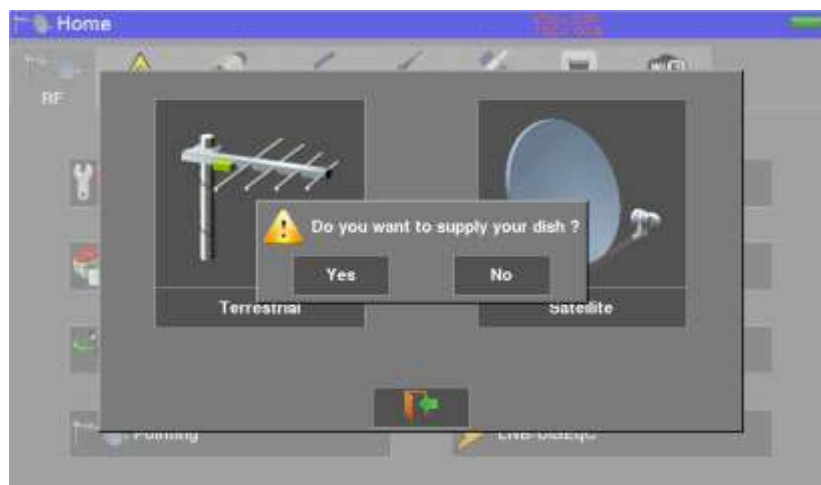

9.1 Terrestrial antenna pointing

The following page appears:



Set your pointer:

- Name of the issuer
- 4 channel settings

You can choose an existing issuer from the available list or create a new one.

This new transmitter will be registered in the list of transmitters for future re-use.

Name of the transmitter :



Enter 4 frequencies or channels of the transmitter that you want to point to.



Once you have completed the four channels, turn the antenna slowly until you hear the melody and get the maximum quality

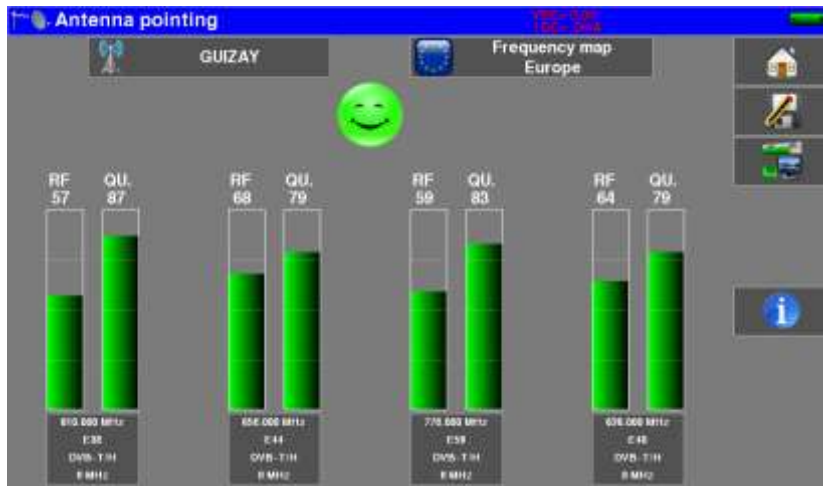

not synchronized on all four channels → RED Smiley



Average reception quality → ORANGE smiley



Good reception quality → GREEN Smiley

Pressing the key



display the service's names distributed on each multiplex:

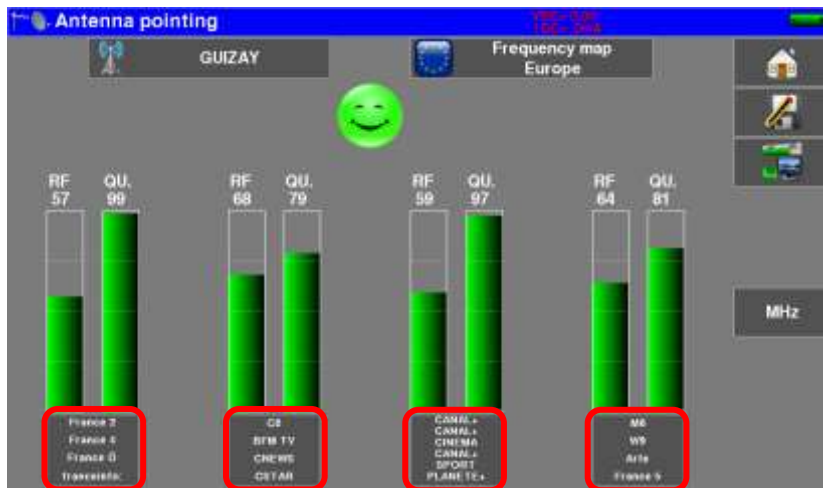

9.1.1 Updating channels

If a channel does not give an indication of Quality, its parameters may have changed.

You can update the parameters by consulting the PDF file posted on the SEFRAM website. It is then enough to modify the frequencies by following the preceding paragraph.



You can find the channel numbers of the various French transmitters on the SEFRAM website (download section) or by clicking on the link below :

http://www.sefram.com/downloads/maj_soft/fr/CANAUX_TNT_FRANCE_2015_2016.xls

You may add new transmitters and update or suppress old ones thanks to a computer and an USB memory stick.

You can use of free PC software TR7837: download it from our website.

Embedded Help will be useful for each work.

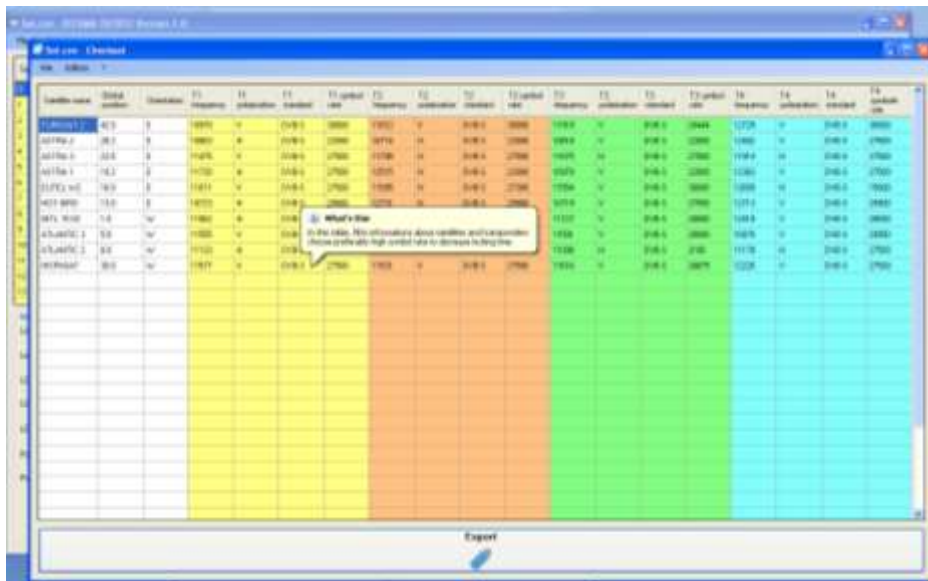

After changes, you only need to record a file **TER.CSV** on an USB memory stick and Import inside your instrument.

9.2 Satellite dish pointing

The following page appears:



Set your pointer:

- Satellite to point
- 4 transponders settings

The appliance has 30 possible orbital positions for satellites. It is provided with 10 satellites registered. 4 transponders are appended to each satellite.

To modify a transponder, you must press the corresponding key.



Once all four transponders have been completed, slowly orient the dish until you hear the locking melody and get the maximum quality.

Also, turn the LNB slightly to obtain the maximum quality (against polarization).

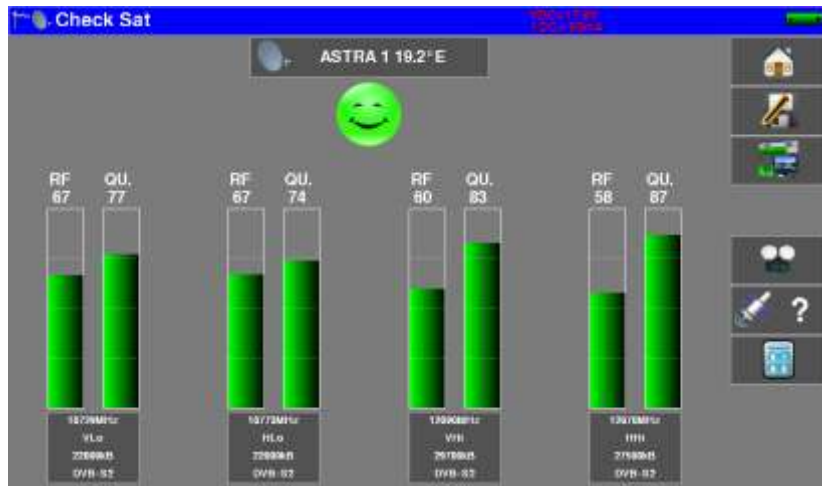

not synchronized on all four transponders → RED Smiley



all transponders locked, but average reception quality → ORANGE smiley



Good reception quality → GREEN Smiley

Attention:

To identify a satellite, it must be synchronized on all 4 transponders.

However, some transponders are regularly modified.
See the frequency map of the satellite if a transponder does not seem to work.

Some switches or LNB work only with DiSEqC commands. In this case, position the OL and the polarization on DiSEqC in the Configuration page LNB-DiSEqC.
(Attention: the Check Sat is slower with DiSEqC commands).

Press the key  to check if the satellite pointed is the right one.

The device then searches the MPEG NIT table on one of the 4 transponders and displays the name of the satellite:





Attention: The displayed name depends on the content of the MPEG NIT table. Some distributors provide no (or poor) such table. The displayed information may be wrong.

9.2.1 Updating satellites

If a transponder does not give an indication of Quality, its parameters may have changed.

You can update the frequencies of the satellite pointers by consulting the PDF file posted on the SEFRAM website.

It is then enough to modify the frequencies by following the preceding paragraph.



You can find the updated list of satellites on the SEFRAM website (download section) or by clicking on the link below :

http://www.sefram.com/downloads/maj_soft/fr/Sat_PDF.pdf

We advise you to check and update your frequencies every 3 months.

You may add new satellites and update or suppress old ones thanks to a computer and an USB memory stick.

You can use of free PC software TR7837: download it from our website.

Embedded Help will be useful for each work.

satellite name	Orbit	Altitude	Frequency	Orbit	Altitude	Frequency	Orbit	Altitude	Frequency	Orbit	Altitude	Frequency	Orbit	Altitude	Frequency	Orbit	Altitude	Frequency
ARTEMIS	EO	3	10750	EO	3	10750	EO	3	10750	EO	3	10750	EO	3	10750	EO	3	10750
ARTEMIS 2	EO	3	10750	EO	3	10750	EO	3	10750	EO	3	10750	EO	3	10750	EO	3	10750
ARTEMIS 3	EO	3	10750	EO	3	10750	EO	3	10750	EO	3	10750	EO	3	10750	EO	3	10750
ARTEMIS 4	EO	3	10750	EO	3	10750	EO	3	10750	EO	3	10750	EO	3	10750	EO	3	10750
ARTEMIS 5	EO	3	10750	EO	3	10750	EO	3	10750	EO	3	10750	EO	3	10750	EO	3	10750
ARTEMIS 6	EO	3	10750	EO	3	10750	EO	3	10750	EO	3	10750	EO	3	10750	EO	3	10750
ARTEMIS 7	EO	3	10750	EO	3	10750	EO	3	10750	EO	3	10750	EO	3	10750	EO	3	10750
ARTEMIS 8	EO	3	10750	EO	3	10750	EO	3	10750	EO	3	10750	EO	3	10750	EO	3	10750
ARTEMIS 9	EO	3	10750	EO	3	10750	EO	3	10750	EO	3	10750	EO	3	10750	EO	3	10750
ARTEMIS 10	EO	3	10750	EO	3	10750	EO	3	10750	EO	3	10750	EO	3	10750	EO	3	10750
ARTEMIS 11	EO	3	10750	EO	3	10750	EO	3	10750	EO	3	10750	EO	3	10750	EO	3	10750
ARTEMIS 12	EO	3	10750	EO	3	10750	EO	3	10750	EO	3	10750	EO	3	10750	EO	3	10750
ARTEMIS 13	EO	3	10750	EO	3	10750	EO	3	10750	EO	3	10750	EO	3	10750	EO	3	10750
ARTEMIS 14	EO	3	10750	EO	3	10750	EO	3	10750	EO	3	10750	EO	3	10750	EO	3	10750
ARTEMIS 15	EO	3	10750	EO	3	10750	EO	3	10750	EO	3	10750	EO	3	10750	EO	3	10750
ARTEMIS 16	EO	3	10750	EO	3	10750	EO	3	10750	EO	3	10750	EO	3	10750	EO	3	10750
ARTEMIS 17	EO	3	10750	EO	3	10750	EO	3	10750	EO	3	10750	EO	3	10750	EO	3	10750
ARTEMIS 18	EO	3	10750	EO	3	10750	EO	3	10750	EO	3	10750	EO	3	10750	EO	3	10750
ARTEMIS 19	EO	3	10750	EO	3	10750	EO	3	10750	EO	3	10750	EO	3	10750	EO	3	10750
ARTEMIS 20	EO	3	10750	EO	3	10750	EO	3	10750	EO	3	10750	EO	3	10750	EO	3	10750

After changes, you only need to record a file **SAT.CSV** on an USB memory stick and Import inside your instrument.



The setting time depends on the rate of the transponder.
The lower the rate, the longer the setting time.
Hence you'd better select high rate transponders to align a satellite dish.

9.2.2 Double Check Sat

This mode allows you to orientate a double LNB by checking 4 transponders on 2 selected satellites.
This mode is identical to the simple Check Sat mode.
To access the double Check Sat mode, you have to trigger the Double key 

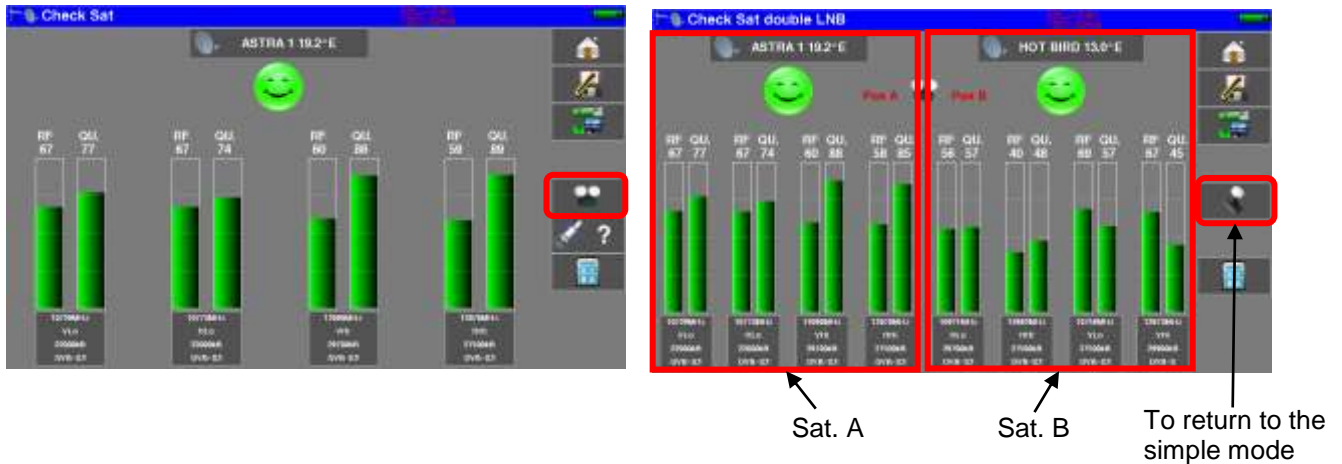

9.2.3 Alignment of the satellite dish

Pressing the « **Alignment** » key  enables the calculation of the Altitude, Azimuth and Polarization values of your satellite dish:

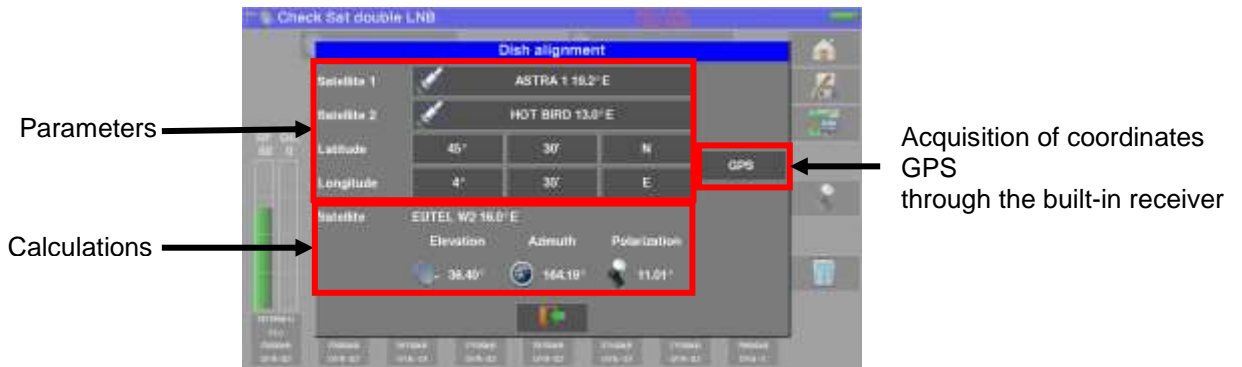

Parameters :

- Satellite 1: satellite to point; or 1st satellite in case of multi-headed satellite dish
- Satellite 2: 2nd satellite in case of multi-headed satellite dish (else, input the same value as satellite 1)
- Latitude: latitude of your current geographical place
- Longitude: longitude of your current geographical place
- GPS: the GPS key inputs automatically the latitude and longitude fields (if the GPS option is available in the appliance)

Calculations :

- Satellite: satellite to aim, the closest to the median position between Satellite1 and Satellite2
- Elevation: tilting angle of the satellite dish
- Azimuth: horizontal angle of the satellite dish with reference to the north
- Polarization: rotation of LNB with reference to a vertical line.

9.2.4 Azimut-Elevation-Polarization

Azimuth

Position of the satellite dish on the horizontal plane with reference to the north. Measured in degrees.



Elevation

Tilt angle under which the beam from the satellite reaches your antenna. Measured in degrees using what is specified on the stand of the satellite dish.

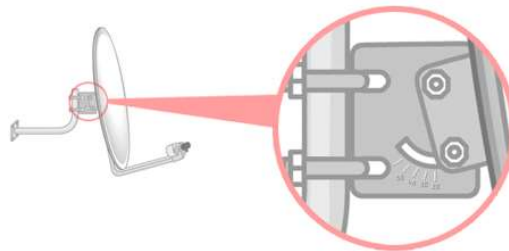

Polarization

Rotation required for the LNB from a vertical line. Measured in degrees.

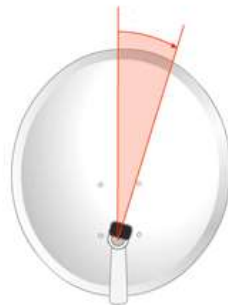

To calculate the parameters of a single-headed satellite dish, enter the same satellite for Check Sat on both parameters '**Satellite 1**' and '**Satellite 2**'.



Note: The list of the available satellites for this calculation is the same as for Check Sat.

10 The Measures-TV-Spectrum page

The "TV-Spectrum Measurement" page  contains Level / BER / MER measurements, access to Spectrum Analyzer, access to the full screen TV image and all signal parameters.

So, pressing the red-circled zones will result in:

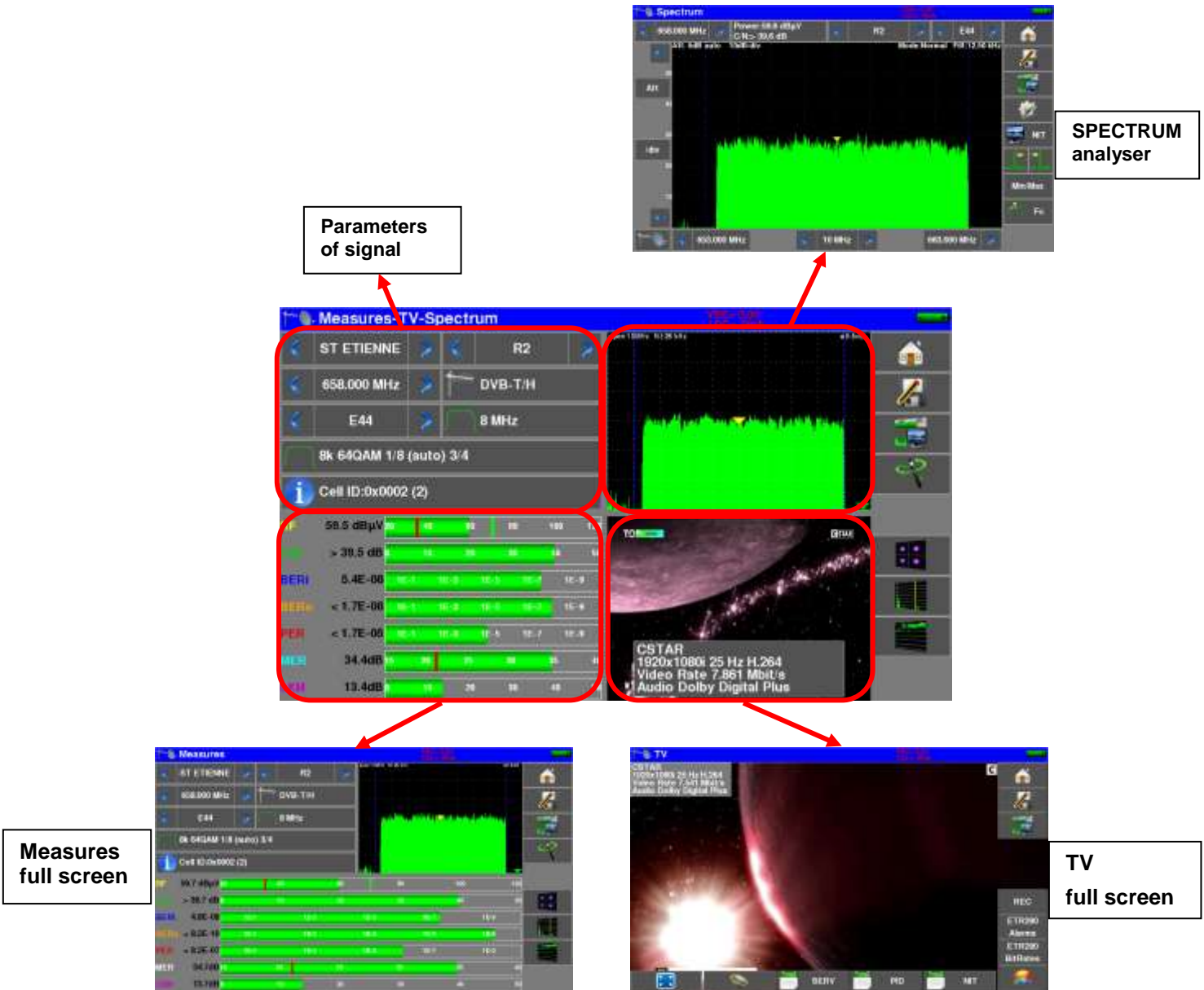

From this page, you can either perform measurements on a program stored in the current list (see chapter "Setting Measurement Lists"), or manually change each of the parameters, or use the "AutoLock" function.

10.1 Modification of parameters

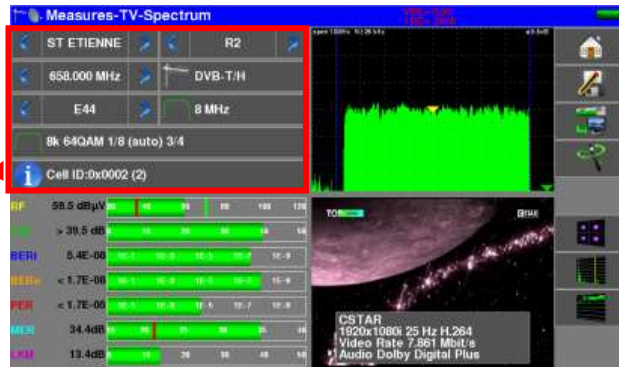

The various parameters are:

- The active List
- The name of the setup
- The frequency of the emitter or transponder
- The standard and bandwidth for DVB-T/H and DVB-T2
- The corresponding channel number for terrestrial and cable mode
- The symbol rate
- The polarization and the band for the satellite
- The audio mode for the analogical TV

	<p>You can shift from terrestrial to satellite mode by:</p> <ul style="list-style-type: none">- Changing the setup frequency- Changing of standard- Changing of setup (from a terrestrial to a satellite setup)
---	---

10.2 « AutoLock » function

This function allows you to lock on a digital channel (cable, satellite or terrestrial)

Just enter the frequency or channel (terrestrial), press the "AutoLock" key  , the device finds in a few seconds the standard, modulation and other signal parameters.

Terrestrial example on channel 38 (frequency 610MHz):





Le fonctionnement est le même en satellite.

The "INFO" key  gives you access to additional indications depending on the standard



10.3 Level measurements

You can measure levels at a specific frequency with a detection matching the standard.

	<p>In terrestrial band, for an user socket, the level should be:</p> <ul style="list-style-type: none"> - between 50 and 66 dBμV under FM - between 35 and 70 dBμV under DVB-T/H, DVB-T2 and DAB/DAB+ - between 57 and 74 dBμV in any other case.
	<p>In satellite band, for an user socket, the level should be:</p> <ul style="list-style-type: none"> - between 47 and 77 dBμV.

The possible measurements are:

- **Average** measurement
- **Peak** measurement
- **Power** measurement.

10.3.1 Satellite band

The following table sums up the measurement types and filters for each standard:

Standard	Video carrier	Measure	filter
PAL	FM	Peak	125KHz
SECAM	FM	Peak	125KHz
NTSC	FM	Peak	125KHz
DVB-S	Digital	Power	125KHz
DSS	Digital	Power	125KHz
DVB-S2	Digital	Power	125KHz

10.3.2 Terrestrial band

The appliance automatically makes level measurements on the **Video carrier wave**.

The following table sums up the measurement types, filters and the frequencies of the audio carrier for each standard:

Standard	Video carrier	Measure	filter	Sound carrier		
				Mono	Stereo	NICAM
BG	negative, AM	peak	25KHz	FM 5.5 MHz	FM 5.74 MHz	DQPSK 5.85 MHz
DK	negative, AM	peak	25KHz	FM 6.5 MHz	FM 6.258 MHz	DQPSK 5.85 MHz
I	positive, AM	peak	25KHz	FM 6.0 MHz		DQPSK 6.552 MHz
L	positive, AM	peak	25KHz	AM 6.5 MHz		DQPSK 5.85 MHz
MN	negative, AM	peak	25KHz	FM 4.5 MHz	FM 4.72 MHz	
DVB-C	digital	power	25KHz			
DVB-T/H	digital	power	25KHz			
DVB-T2	digital	power	25KHz			
DAB/DAB+	digital	power	25KHz			
FM	FM	average	25KHz			
Carrier	not modulated	average	25KHz			

The appliance displays the level of the **Video** carrier wave, the **C/N** ratio and the ratio **Video/Audio** in case an analog standard.

10.4 C/N

The device automatically measures C / N (carrier to noise ratio).



The calculation of C / N depends on the chosen standard:

analog standard: $C / N \text{ (dB)} = \text{carrier} - \text{noise} - 10 \times \log (\text{bandwidth} / \text{filter})$

digital standard: $C / N \text{ (dB)} = \text{carrier} - \text{noise}$

Standard	'carrier' detection	'noise' détection	bandwidth	filter
Analog TV BG, DK, I, L	peak	mean	5 MHz	25KHz
Analog TV MN	peak	mean	4MHz	25KHz
Digital TV Terrestrial	mean	mean	5, 6, 7 ou 8MHz	25KHz
DAB/DAB+	mean	mean	1.7MHz	25KHz
Digital TV satellite	mean	mean	bitrate x (1+rolloff)	125KHz

10.5 Thresholds

Predefined thresholds are used to assess if the measurement is pertinent.

Standard	Min	Max
Analogical terrestrial TV	57	74
DVB-C/C2, J83B	57	74
DVB-T/T2	35	70
DAB-DAB+	35	70
FM, carrier	50	66
Analogical satellite TV	47	77
DVB-S, DSS	47	77
DVB-S2	47	77

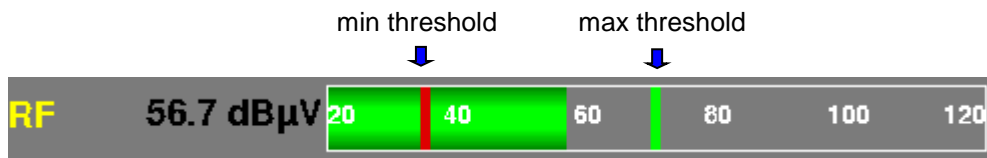

Decision thresholds are used to display the measures « Power Level » and « Measurement Map »:

10.6 Digital measurements

In digital standards, in addition to the **RF** level and to the **C/N** hereabove, the appliance also displays :

- different BER (Bit Error Rate): ratio false bits / transmitted bits
- the Packet Error Rate (PER): ratio false packets / transmitted packets
- the MER (Modulation Error Ratio): digital signal-to-noise ratio
- LKM (Link Margin): difference between measured MER and MER before unlocked (this is the margin available before unlocking.)



The bargraphs are displayed with colors depending on the measured error rates:

- GREEN: good error rates
- ORANGE: BER_o > 10⁻⁴ (QEF : Quasi Error Free) without lost packet
- RED: lost packets (PER).

An automatic frequency check (AFC) is automatically activated in error rate measurement mode.



“**Sync ?**” displayed on screen means that the signal is absent or unlocked; check its presence, the modulation parameters, the presence of remote power supply and the LNB and DiSEqC parameters under satellite band.



The sign < before a value or error rate shows that there is no error but that 10^{-x} bits have been tested (i.e. $<10^{-8}$ means that 10^8 bits have been tested).



You can shift from terrestrial to satellite mode by:

- Changing the setup frequency
- Changing of standard
- Changing of setup (from a terrestrial to a satellite setup)

10.7 DVB-T/H

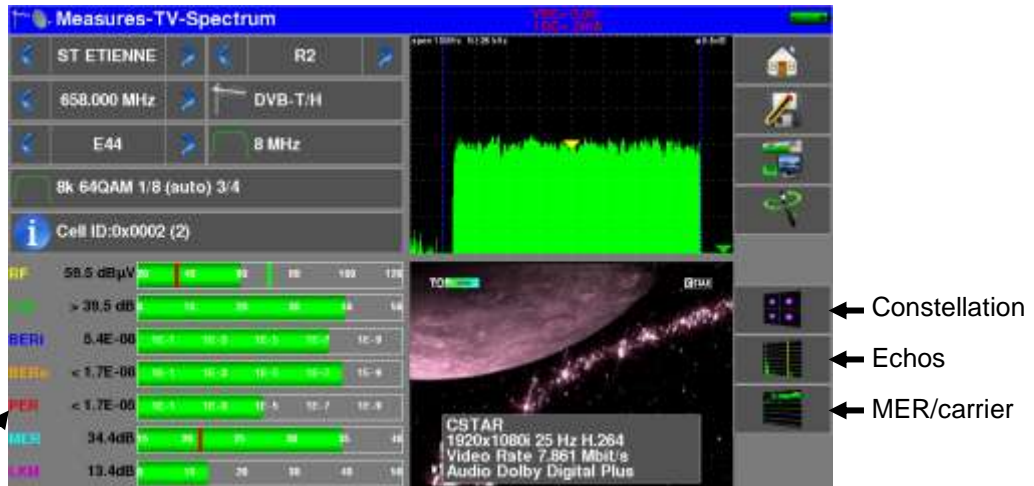
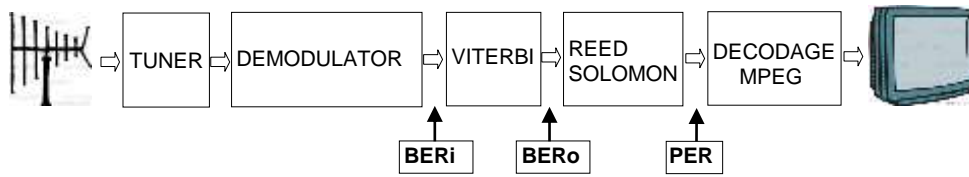

Display of the measures of:

- **BERi:** error rate before Viterbi
- **BERo:** error rate after Viterbi
- **PER:** error rate after Reed Solomon (error rate packet)
- **MER:** modulation error rate
- **LKM:** noise margin (Link Margin)

BERx: 'bits' error rate

Ratio between the number of false bits / number of transmitted bits during the measurement time

PER: 'paquets' error rate

Ratio between the number of false packets / number of transmitted packets during the measurement time

Recall: under DVB-T/H, a packet is made of 188 bytes; a packet is "false" if it includes more than 8 wrong bytes (correction by Reed Solomon coding).

Display of the type of **Modulation** detected:

- number of carriers (8 K)
- constellation (64QAM)
- guard interval (1/32 auto)
- Viterbi rate (2/3)
- spectrum inversion

In case of poor signal quality or co-frequent analogical signal, it is wise to switch to the manual guard interval mode. To do so, you have to select the « Modulation » line and set the guard interval parameter to the right value.

Display of the value of Cell ID from the diffuser and specific to the emitter.

10.8 DVB-T2 / T2 Lite

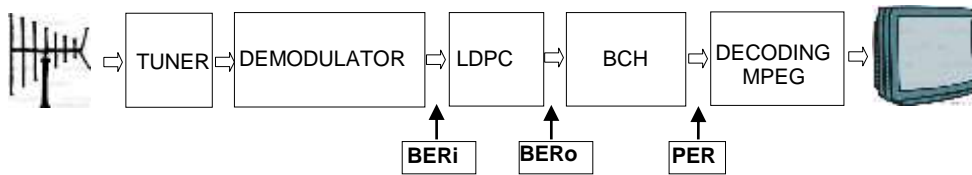

Display of the measures of:

- **BERi**: error rate before LDPC
- **BERo**: error rate after LDPC
- **PER**: error rate after BCH (lost packets)
- **MER**: modulation error rate
- **LKM**: noise margin (Link Margin)

Recall:

LDPC: Low Density Parity Check

BCH: Bose Chauhuri Houqueno hem

The concatenation Viterbi + Reed Solomon of the correction of DVB-T/H has been replaced by the concatenation LDPC + BCH under DVB-T2.

Display of the type of **Modulation** detected:

- number of carriers (32 K)
- constellation (256QAM R)
- guard interval (1/8)
- Viterbi rate (3/5)

Display of the values of Network_ID, System_ID, Cell_ID from the diffuser and specific to the emitter.

10.9 DVB-C

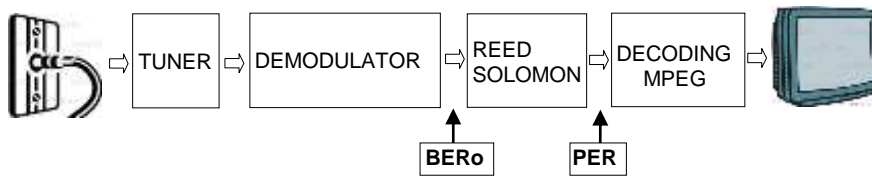

Display of the measures of:

- **BERo:** error rate before Reed Solomon
- **PER:** error rate after Reed Solomon (error rate packet)
- **MER:** modulation error rate
- **LKM:** Noise margin (Link Margin)

BERo: error rate 'bits'

Ratio between the number of false bits / number of transmitted bits during the measurement time

PER: error rate 'packets'

Ratio between the number of false packets / number of transmitted packets during the measurement time

Recall: under DVB-C, a packet is made of 188 bytes; a packet is "false" if it includes more than 8 wrong bytes (correction by Reed Solomon coding).

10.10 J83B (MCNS)

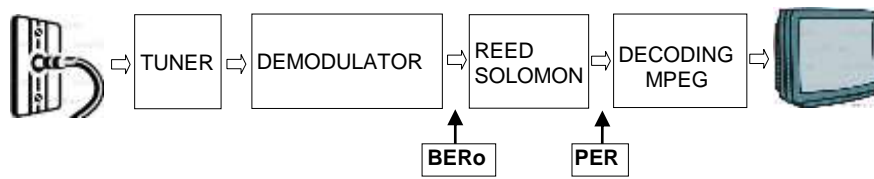

Display of the measures of:

- **BERo:** error rate before Reed Solomon
- **PER:** error rate after Reed Solomon (error rate packet)
- **MER:** modulation error rate
- **LKM:** Noise margin (Link Margin)

BERo: error rate 'bits'

Ratio between the number of false bits / number of transmitted bits during the measurement time

PER: error rate 'packets'

Ratio between the number of false packets / number of transmitted packets during the measurement time

Recall: Under J83-B, a packet is made of 188 bytes; a packet is "false" if it includes more than 8 wrong bytes (correction by Reed Solomon coding).

10.11 DVB-C2

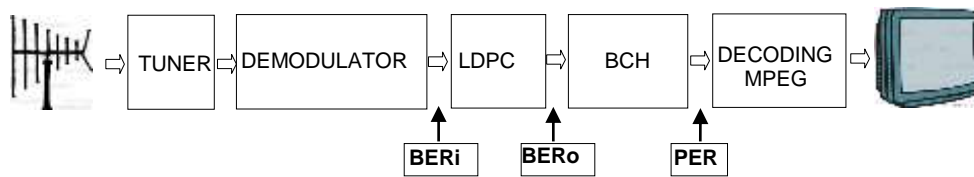

Display of the measures of:

- **BERi**: error rate before LDPC
- **BERo**: error rate after LDPC
- **PER**: error rate after BCH (lost packets)
- **MER**: modulation error rate
- **LKM**: noise margin (Link Margin)

Recall:

LDPC: Low Density Parity Check

BCH: Bose Chauhuri Houquenochem

Display of the type of **Modulation** detected:

- number of carriers
- constellation
- guard interval
- Viterbi rate
- Active PLP and Data Slice

10.12 DVB-S and DSS

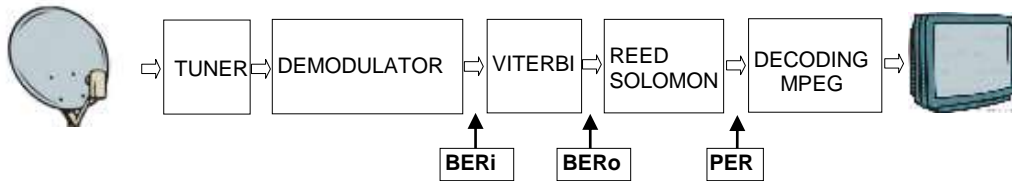

Display of the measures of:

- **BERi** : error rate before Viterbi
- **BERo** : error rate after Viterbi
- **PER** : error rate after Reed Solomon (error rate paquet)
- **MER** : modulation error rate
- **LKM** : Noise margin (Link Margin)

BERx : error rate 'bits'

Ratio between the number of false bits / number of transmitted bits during the measurement time

PER : error rate 'paquets'

Ratio between the number of false packets / number of transmitted packets during the measurement time

Recall: Under QPSK (DVB-S) a packet is made of 204 octets; a packet is "false" if it includes more than 8 wrong octets (correction by Reed Solomon coding). Under DSS, a packet is made of 146 octets.

Display of the type of **Modulation** detected:

- constellation (QPSK)
- Viterbi rate (3/4)

10.13 DVB-S2

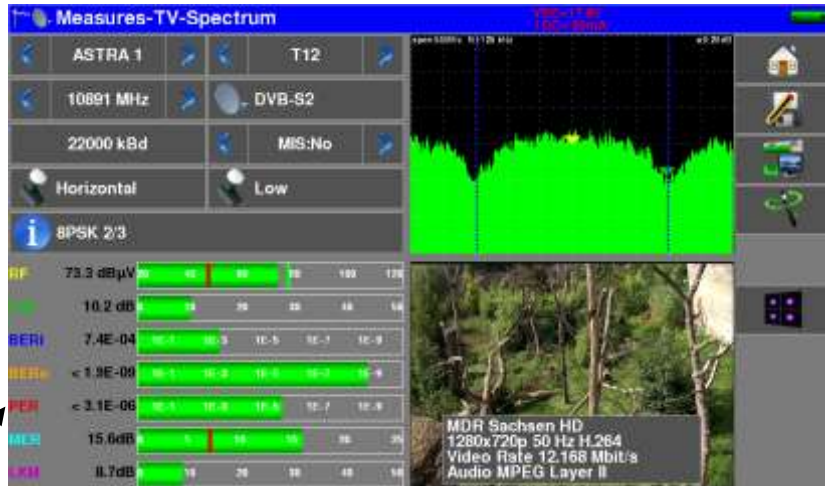
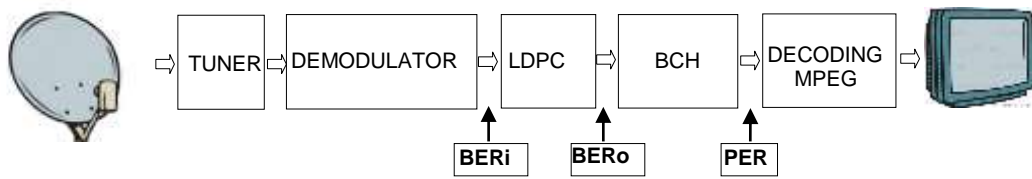

Display of the measures of:

- **BERi** : error rate before LDPC
- **BERo** : error rate after LDPC
- **PER** : error rate after BCH (lost packets)
- **MER** : modulation error rate
- **LKM** : Noise margin (Link Margin)

Recall:

LDPC: Low Density Parity Check

BCH: Bose Chauhuri Houquenoheh

The concatenation Viterbi + Reed Solomon of the correction of DVB-S has been replaced by the concatenation LDPC + BCH under DVB-S2.

Display of the type of **Modulation** detected:

- constellation (8PSK)
- Viterbi rate (2/3)

10.13.1 Multistream

The 'Multistream' option allows you to view a DVB-S2 signal that uses Multiple Transport Stream technology (several multiplexes are transported on the same transponder simultaneously).

Example: broadcasting of the two multiplexes of the TNT on **Eutelsat 5 West A 5°W** inside the same transponder

Frequency: 12648MHz Vertical, DVB-S2 29500, ISI: 1, Gold code: 121212

To turn ON the Multistream, press "MIS":

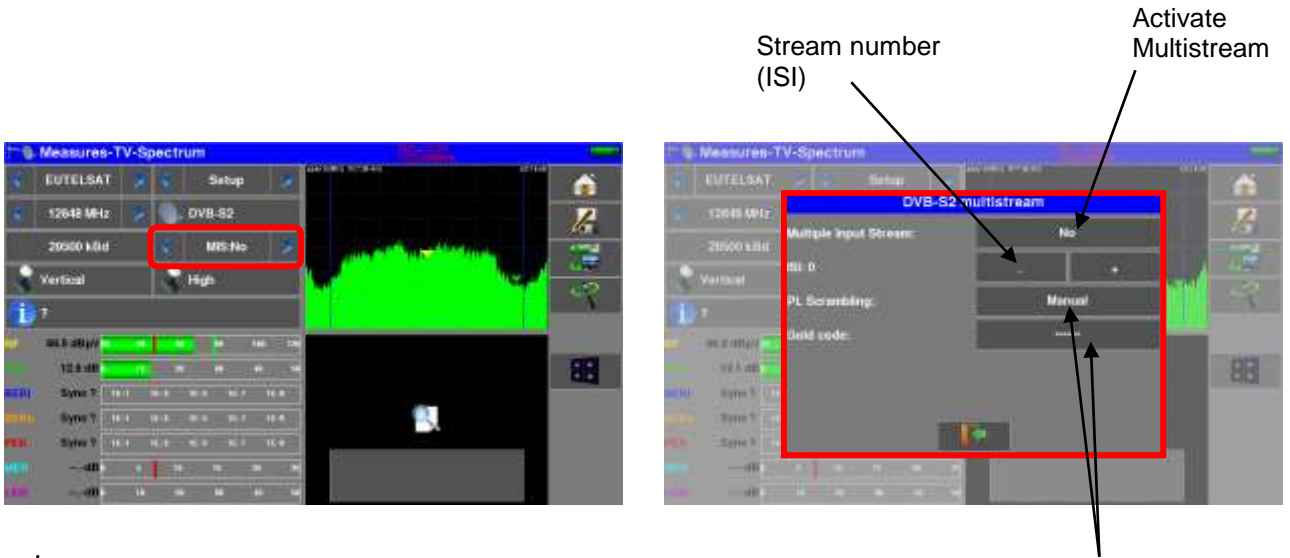

Proprietary stream coding: PL Scrambling

- NO: no coding
- MANUAL: a code to enter
- AUTO: the 3 codes to enter are tried successively by the device



10.14 FM-RDS

FM radio demodulation and RDS services display.

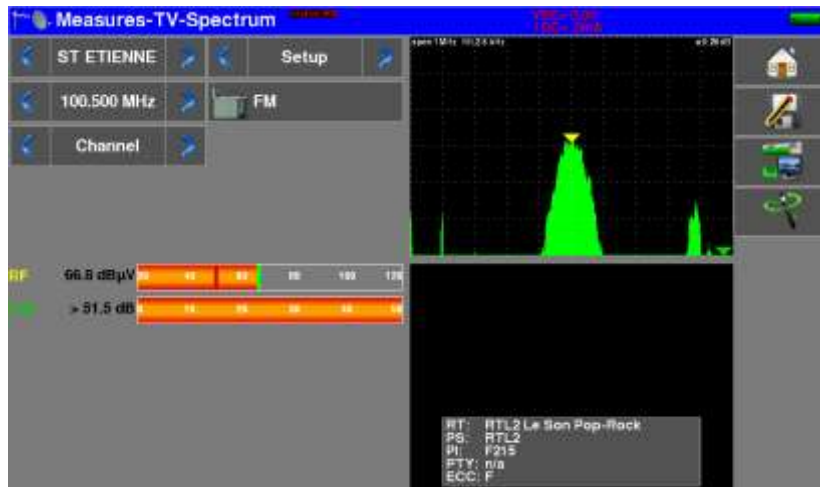

- **RT (Radio Text)**

Texts diffusion; few nets use it to send referencies of musics currently playing.

- **PS (Program Service)**

Station name, 8 letters long. The RDS standard explain that these 8 letters must be fixed, and are the name of the station. In practice, few radio station used this service to pass dynamic informations.

- **PI (Program Identification)**

PI code is an single code for each station (16 bits display in hexadecimal).

- **PTY (Program TYPe)**

Program Type for current reception, from 32 types predefined.

- **ECC (Extended Country Code)**

PI code est completed with the country code ECC.

The couple PI+ECC made this ID really single for one station all other the world.

10.15 DAB/DAB+

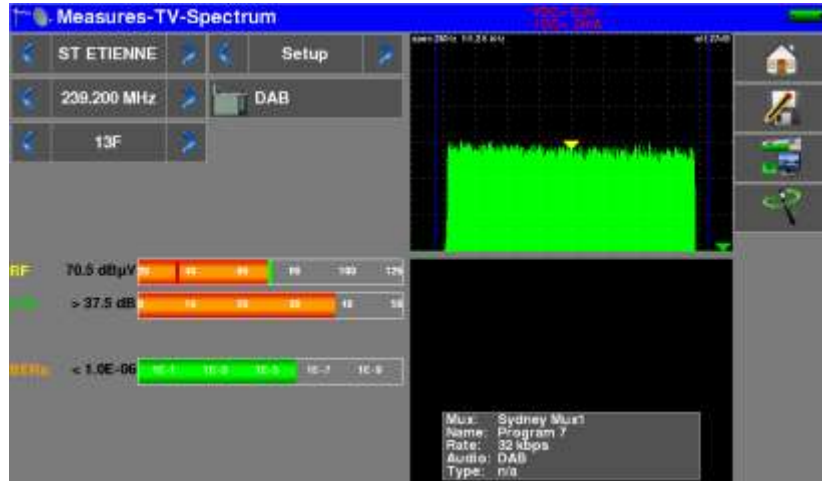

DAB/DAB+ digital radio demodulation and services display.

DAB is a Digital audio radio diffusion using COFDM modulation carrying audio using system MPEG Layer 2.

- DAB : sound MPEG Audio Layer II
- DAB+ : sound HE-AAC V2.

Display of :

- **BERo** : bit error rate measurement; convolutive coding for DAB, Reed-Solomon for DAB+
- Service information:
 - Ensemble name : multiplex name
 - Service name
 - Service binary bit rate Kbits/s
 - current diffusion standard DAB /DAB+
 - Service type (News, Sport, Pop Music, Weather, ...)

List of Services inside current multiplex :



11 Spectrum analyser

Pressing SPECTRUM gives access to the **SPECTRUM ANALYSER** function.

(frequency / amplitude graphical representation of the signals present at the input of the device)

Cursor frequency
entering the cursor position

Measurement cursor
level, C/N

Cursor :
Manual Positioning

Setup :
Setup from active list

Channel:
Terrestrial channel number

Reference level:
press arrows to modify

Att :
attenuator (auto, 5, 10, 15dB,...)

/div :
level scale 2, 5 or 10dB/div

Mode :
terrestrial/satellite

Span :
excursion around the central frequency

Frequency range:
press arrows to modify

Display:
mean/max/hold/zoom /...

NIT/TV:
TV and NIT image overlay

Cursor:
automatic positioning (peak/min/max/center)

Satellite :

In Satellite mode, remote power control:

On / Off, horizontal / vertical polarization, low / high band

Half keys:
LNB or CURSOR control

The input attenuator is automatically positioned according to the "Reference Level".

The filter is also automatically positioned according to the "Span".

The value of the filter is indicated at the top of the spectrum



Beware of saturation risks, use the formula:

$$\text{Input attenuator} = \text{Reference level} - 60 \text{ dB}\mu\text{V}.$$

Example: to correctly display a 110 dB μ V signal, you need a 50 dB attenuator

11.1 Display modes

The spectrum display modes are:



- **Normal** Normal sweep

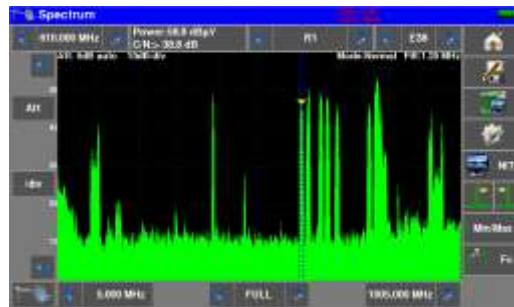

- **MaxHold** Keeps crests on every sweep

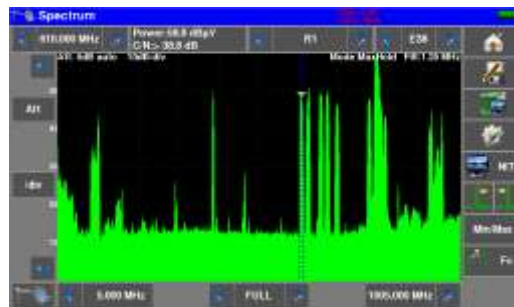

- **Average** Averaging at each sweep



- **Single** Hold back the last sweep

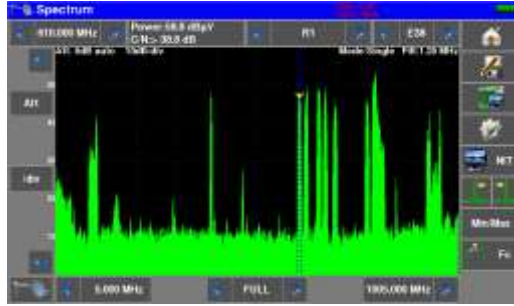

- **Buzzer** auditory indication of the total power seen

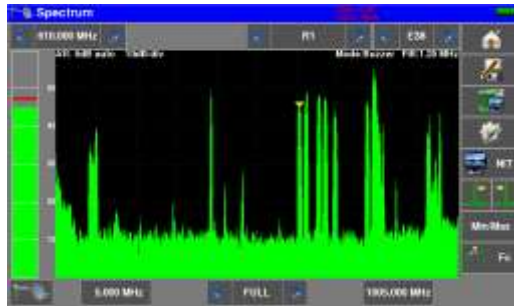

- **Zoom** double display, zoom of the spectrum under the cursor (10MHz in terrestrial, 50MHz in satellite)

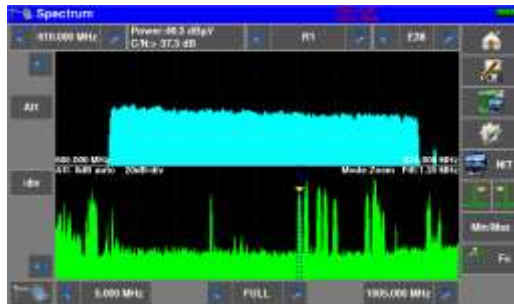

- **LTE** Simulation of an LTE filter (4G); influence on high frequencies (4G present on channel 61 to 69).

The red curve corresponds to the spectrum with filter (example: channel 59 is attenuated).

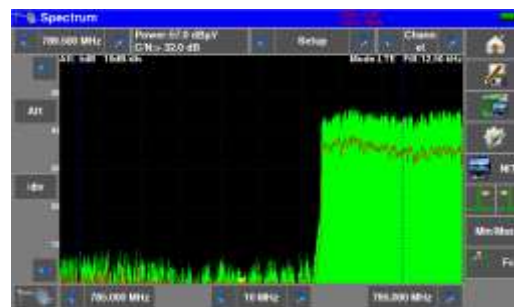

- Full or wired plot



- Measurement with 2 cursors: display of level / frequency differences

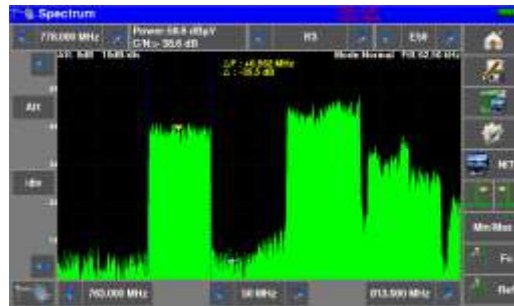

11.2 NIT/TV

This mode is used to display the TV channel pointed by the cursor in the spectrum page, this mode works in terrestrial, cable and satellite.

The message displays the name of the channel "Network Name" and "Network id"



In satellite, the device also displays the name of the satellite and its position





The display of a TV program is possible only for non-encrypted channels. For encrypted channels, the instrument will display « conditional access ».

Displaying TV program can take several seconds because the instrument is looking for standard and modulation of the channel before being able to decode and display the program.

Some broadcasters did not fill the MPEG NIT information.

Instrument can display only the information supplied by broadcasters in the digital signals.

12 Image and Sound

Pressing the TV zone gives access to the TV function.



Pressing the key  switches to full screen mode, the image uses the entire screen, the only remaining indication battery and current-voltage remote power supply:



To exit this mode, simply press anywhere on the screen.

12.1 Digital TV

The name of the service and its main characteristics are displayed on top right of the screen.

- 720x576i: picture resolution 720 pixels / line, 576 lines, interlace
- 25 Hz: frame frequency
- MPEG-2 or H264 or HEVC: picture compression
- Video Rate : instantaneous binary rate of the service
- Audio MPEG Layer II: sound compression



12.2 Audio

To set the volume, press  an adjustment bar shows up:

The instrument can decode the following digital sound formats:

MPEG-1 L1/L2

AAC Advanced Audio Coding License Via Licensing

HE-AAC High Efficiency AAC License Via Licensing

Dolby Digital License Dolby®

Dolby Digital Plus License Dolby®

Made under **licence** by **Dolby** laboratories.

Dolby and the double-D symbol are trademarks of **Dolby Laboratories**

12.3 Table of services

Pressing  gives access to the list of services:



This function also allows you to select the channel you want to display. You only have to press the line you want.

12.4 PID function

Pressing  gives you access to the PID list:



The various PID are described under this function.

In the case of a multilingual emission, you can change the language by pressing the line you want.
Example: PID 732/Audio MPEG1 for an emission in German (code deu).

12.5 NIT function

Pressing  gives you access to the NIT list:



This function allows the display of the « Network Information Table » of the multiplex.
The name of the network and some other helpful information are shown in this list.

12.6 Record function PVR

When using  function, the instrument will record on USB memory stick the transport stream (audio and video). The stream is the one of the displayed channel. File type is *.TS

The first press on Rec start recording; a second press stops recording.

Only the current Service (displayed) will be registered with the necessary Service Tables.



Notes:

- it is not possible to play back the recorded stream by the instrument
- the *.TS file can be played on a computer with appropriate software
- when recording an encrypted channel, the record keeps the encryption.

12.7 ETR290 Alarms function

Pressing **ETR290 Alarms** gives you access to the ETR290 Alarms function.



The instrument analyze in real time, the Transport Stream (TS) according the DVB recommendation TR101290 defining an Alarms list.

Each error detected is displayed with a red cross beside its meaning **✘ 1.6 PID_error** .

These alarms are recorded (latched) on the display to help you to detect a short error along a long time analyzing.

The status of each alarm can be simultaneously recorded on an USB stick : a file TSLOGxx.txt is created with date and time of each alarm detected.

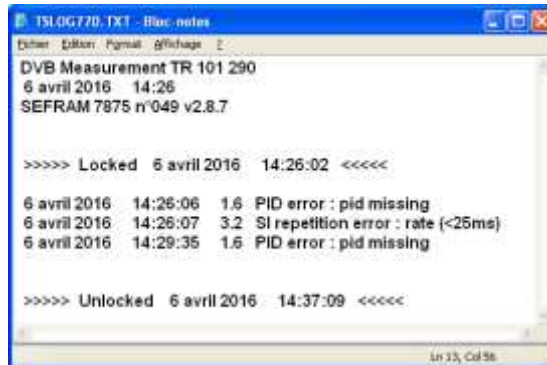

12.8 ETR290 Bitrates function

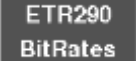
Pressing the key  accesses the ETR290 BITRATES function.



The device analyzes the Transport Stream (TS), and measures for each Service its bit rate and occupation in the Multiplex.

In the list of Services are displayed, for each Service:

- the current bit rate
- the measured minimum
- the maximum measured
- the percentage occupied in the total multiplex

A graphic display is also possible:

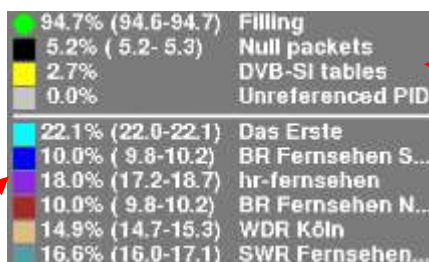
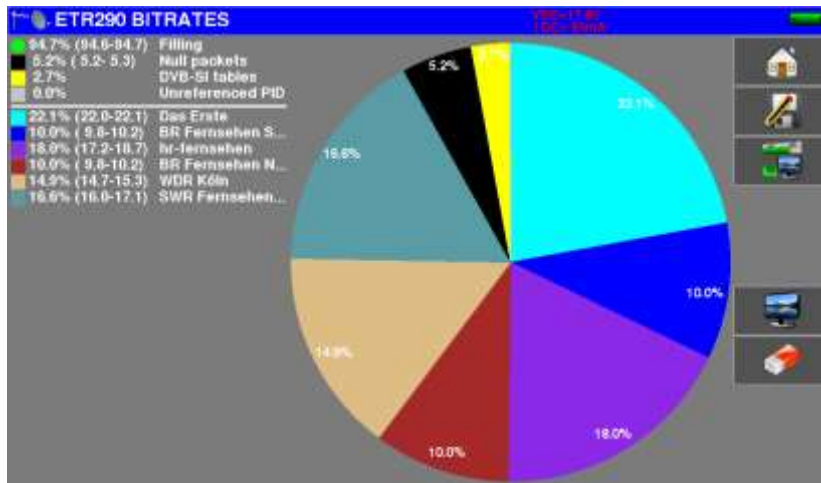

Multiplex:
 - total occupation
 - 'Null' packets
 - Services tables

Bit rate per service :
 - percentage
 - minimum
 - maximum

12.9 CAM installation / Access card

To display encrypted services, it is necessary to install a CAM (Conditionnal Access Module) and a valid Access card inside the instrument.

The slot of the CAM is placed on left side of the instrument.

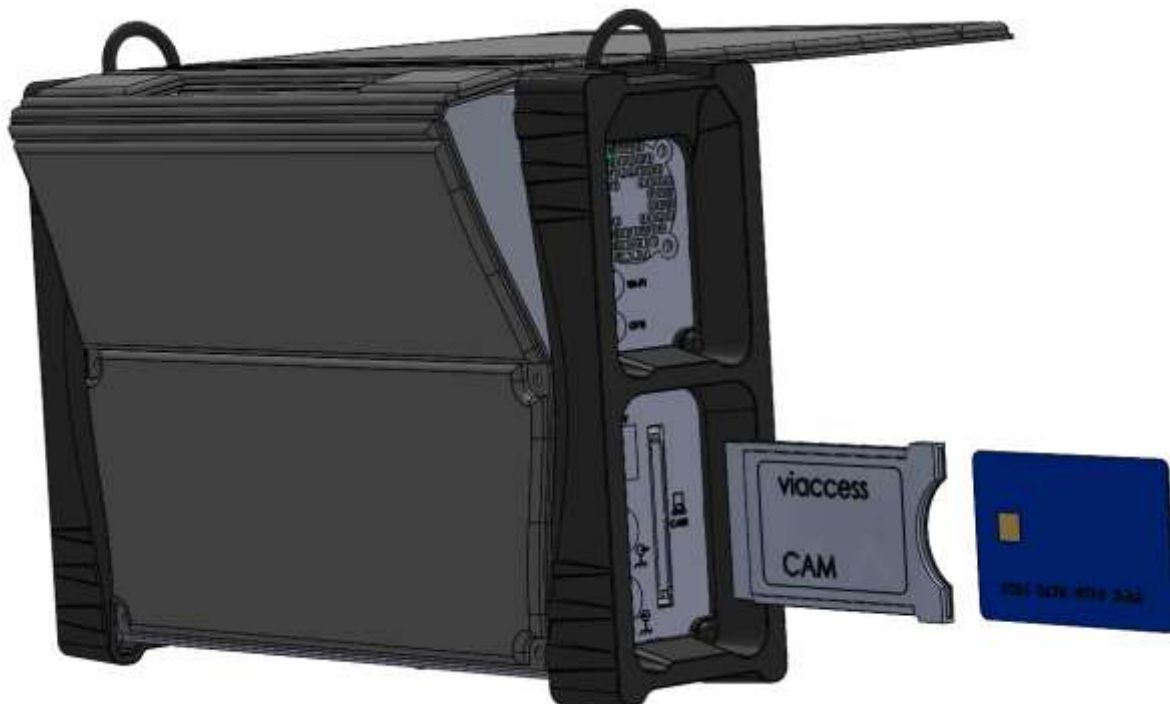

If the displayed TV channel is encrypted, the appliance automatically checks on the CAM interface whether a subscription card is present and whether the encryption key is compatible (access rights).



Note : the CAM should be recognized by the instrument.



Leave your CAM in place to hide the opening.

If the CAM is not present, there is a risk of deterioration of the electronics.

The manufacturer can not be held responsible for the consequences. It is recommended to close this opening.

13 Monitoring

The "Monitoring" function can be accessed from the HOME page by pressing



It allows to record on a defined time, all the measurements made on the current signal:

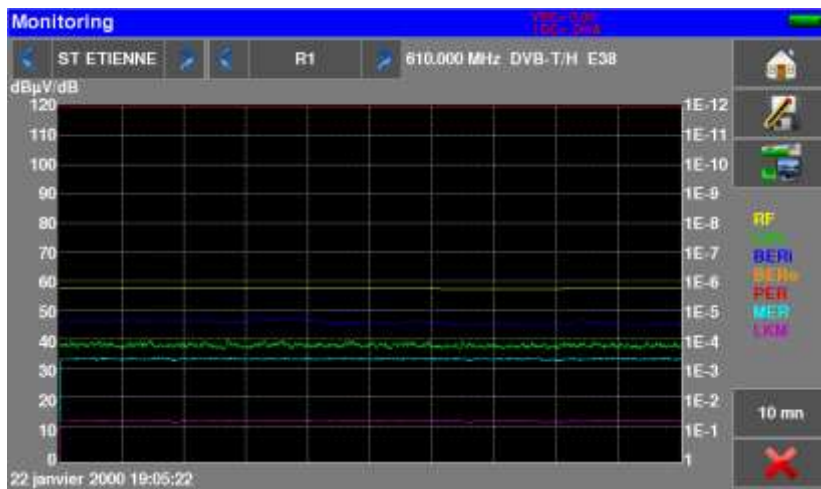
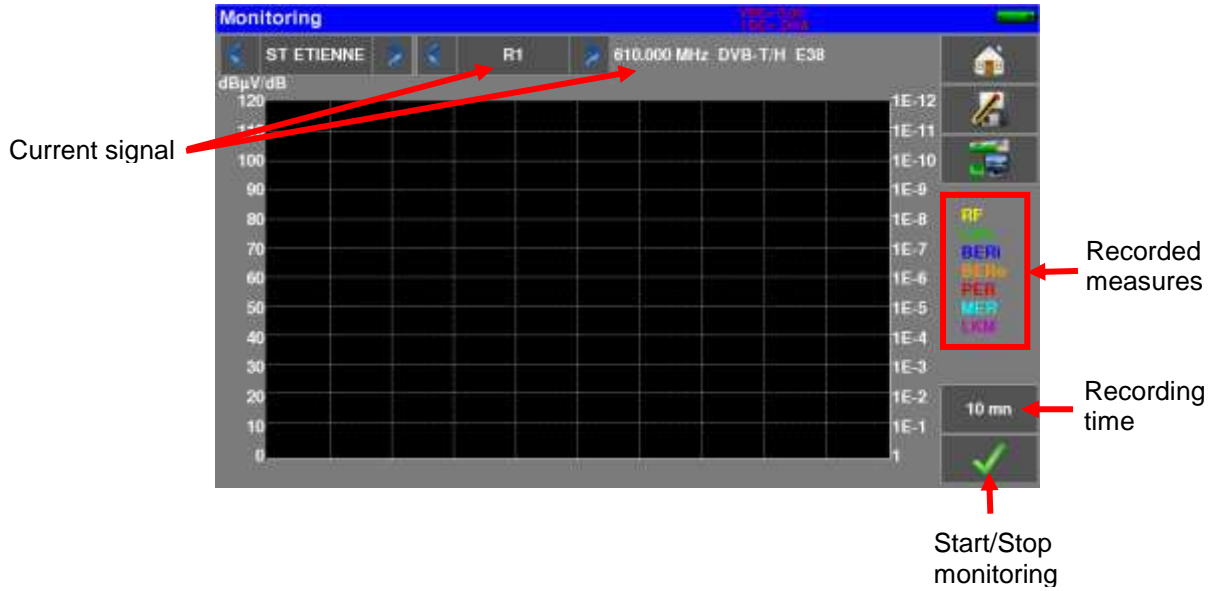

14 Remote power supply / LNB – DiSEqC

The  key gives you access to the remote power supply / LNB-DiSEqC.

To start the remote power supply, press the key :

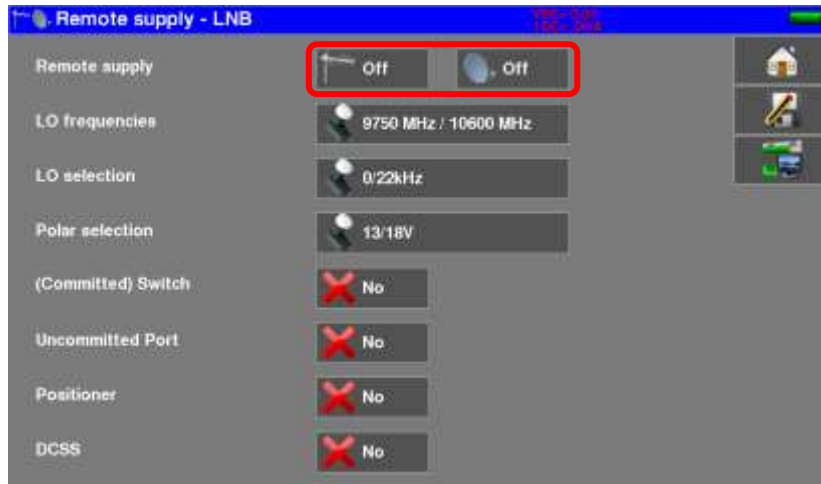

The window allows you to select the remote power supply on terrestrial and/or satellite mode.

14.1 Terrestrial band

In terrestrial mode, you can select:

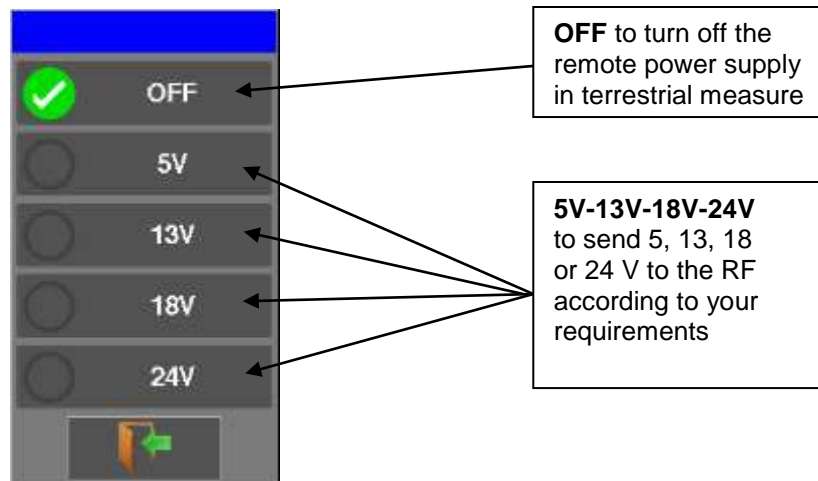

A green check shows up where you validated.

14.2 Satellite band

14.2.1 Launching

Setting the remote power supply to satellite:

OFF to turn off the remote power supply under satellite measure

ON to turn on the remote power supply under satellite measure

AUTO to launch automatically the remote power supply in satellite measure mode even after shutting off

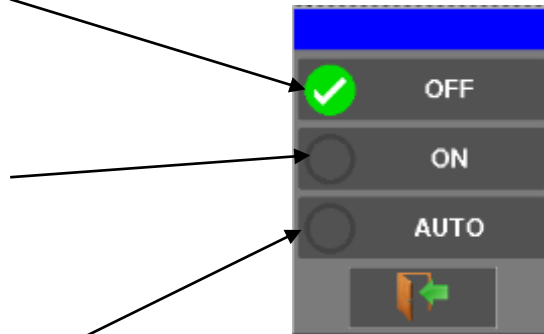

Configuration lines:

- **LO frequency:** LO frequencies for low and high bands

- **LO selection:** band commutation on the LNB (22kHz, ToneBurst or DiSEqC)

- **Polar selection:** polarization commutation on the LNB (13/18V or DiSEqC)

- **Switch:** switch type and position (No, ToneBurst, 22kHz, DiSEqC, Pos A, B, C or D)

- **Uncommitted:** "Uncommitted" switch type and position (No, DiSEqC, Pos 1 to 16)

- **Positioner:** presence of a positioner (Yes / No)

- **DCSS:** Digital Channel Stacking (2 modes SATCR and SCD2 single cable distribution)

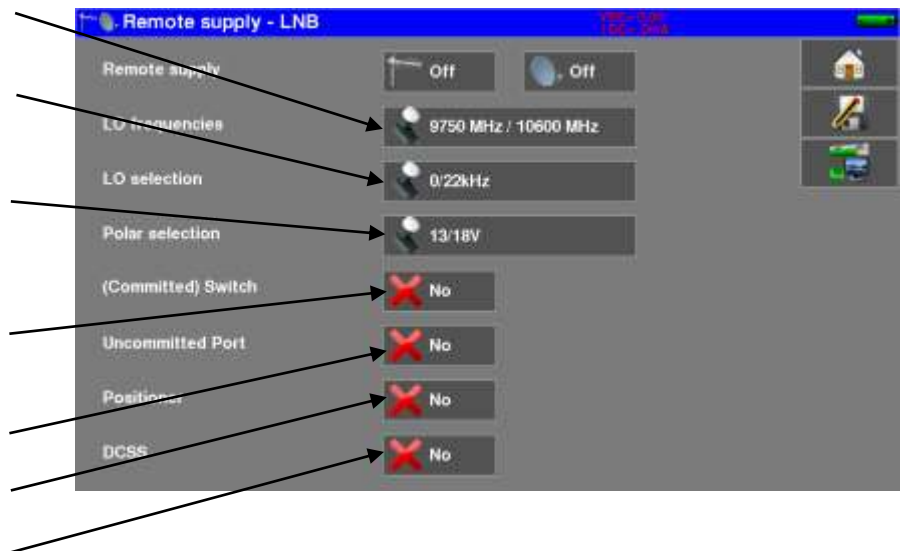

14.2.2 Switches

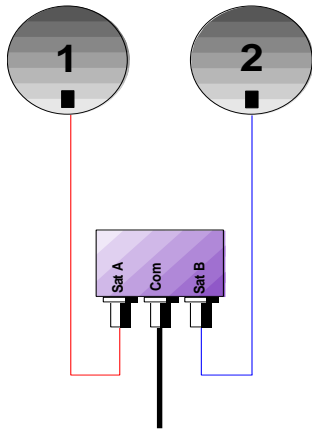

2-satellite switch

* 22 kHz

* ToneBurst (MiniDiSEqC)

*DiSEqC Committed or Uncommitted

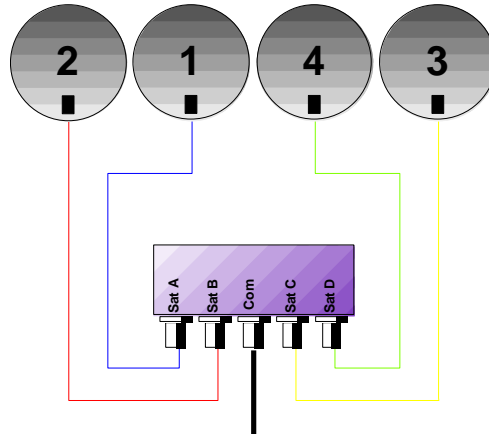

4-satellite switch

* DiSEqC Committed or Uncommitted

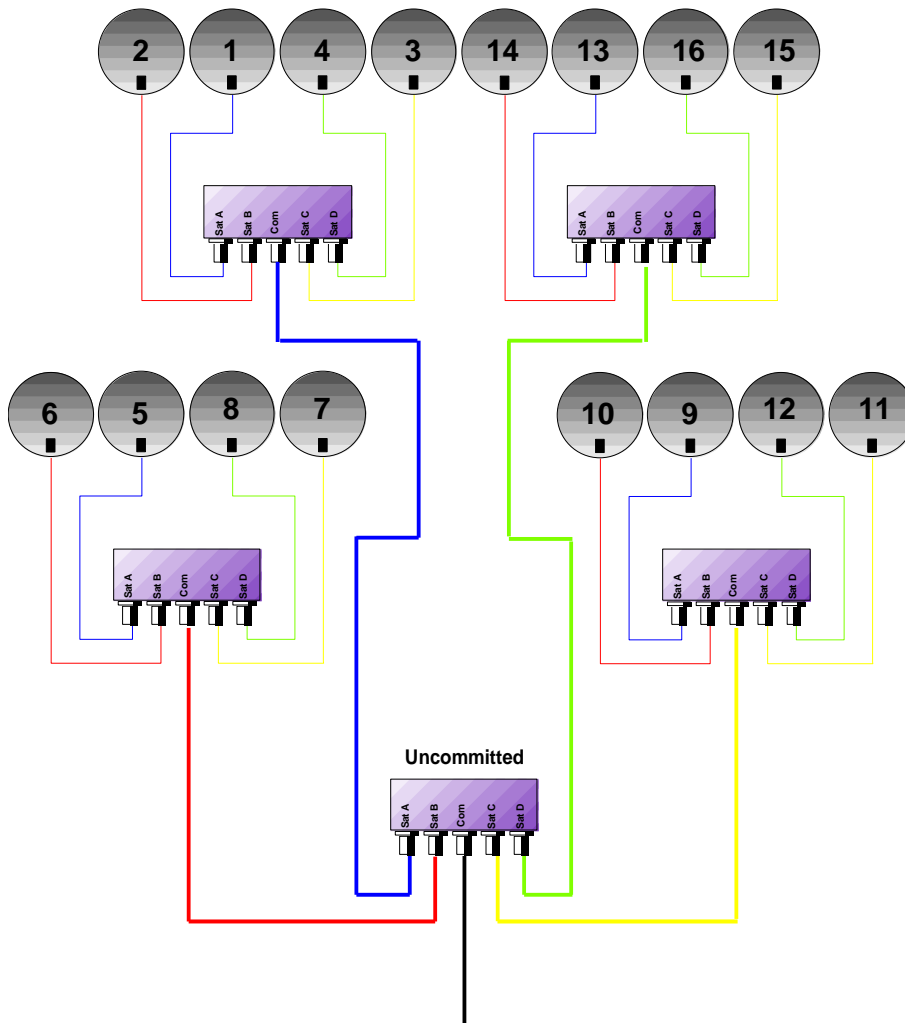

16-satellite switch

* DiSEqC Committed + Uncommitted

Satellite	Switch line		Uncommitted line	
	Position	Commande DiSEqC	Position	Commande DiSEqC
1	Pos A	Option A + Position A	Pos 1	Input 1
2	Pos B	Option A + Position B	Pos 1	Input 1
3	Pos C	Option B + Position A	Pos 1	Input 1
4	Pos D	Option B + Position B	Pos 1	Input 1
5	Pos A	Option A + Position A	Pos 2	Input 2
6	Pos B	Option A + Position B	Pos 2	Input 2
7	Pos C	Option B + Position A	Pos 2	Input 2
8	Pos D	Option B + Position B	Pos 2	Input 2
9	Pos A	Option A + Position A	Pos 3	Input 3
10	Pos B	Option A + Position B	Pos 3	Input 3
11	Pos C	Option B + Position A	Pos 3	Input 3
12	Pos D	Option B + Position B	Pos 3	Input 3
13	Pos A	Option A + Position A	Pos 4	Input 4
14	Pos B	Option A + Position B	Pos 4	Input 4
15	Pos C	Option B + Position A	Pos 4	Input 4
16	Pos D	Option B + Position B	Pos 4	Input 4

14.2.3 Positioner

The appliance sends a DiSEqC command that triggers the rotation of a motorized satellite dish.



In this example, the position is 9 (1 to 127 pre-loaded positions in the positioner)

If the positioner is on No, it is deactivated

14.2.4 DCSS

Description:

DCSS Digital Channel Stacking system : signal distribution system using frequency transposition.

Used in satellite distribution for multiple or single dwelling, with several set top boxes.

To give several receptors access to the whole spectrum and all polarizations, you need **one coaxial cable per receptor** and a suitable installation (multiple LNB, Quattro and multi-switches).

The **DCSS system** allow to feed dwellings with one or more satellites using only one coaxial cable (**SCD=SINGLE CABLE DISTRIBUTION**).

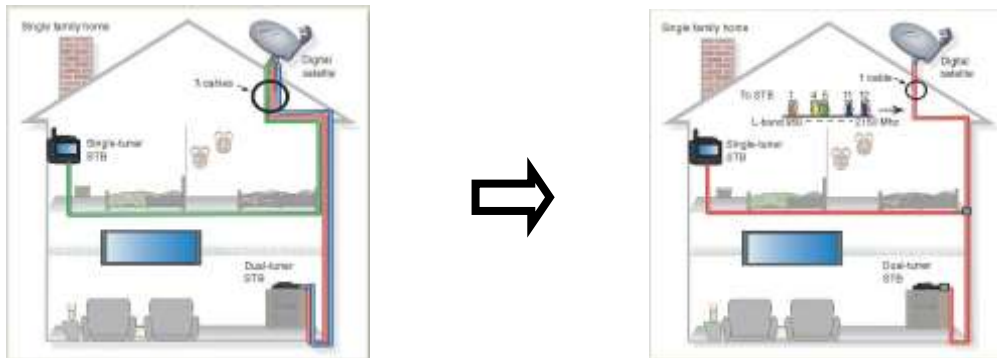

The DCSS is an extension of the DiSEqC protocol that allows the connection of several receptors on **only one coaxial cable**, no matter the band (H/L) and the polarization (H/V).

Functioning:

Each satellite receptor uses a fix frequency band (**Slot** or **Port**), whose width is (more or less) equal to the width of the transponder.

The receptor requires a specific transponder frequency (frequency Ku) via a DiSEqC command.

Some equipment on the satellite dish (LNB or switch) moves the requested signal to the center of the selected band (**Slot**). Then, the mixing equipment adds each user band (**Slot**) to only one output (up to 32 user bands).

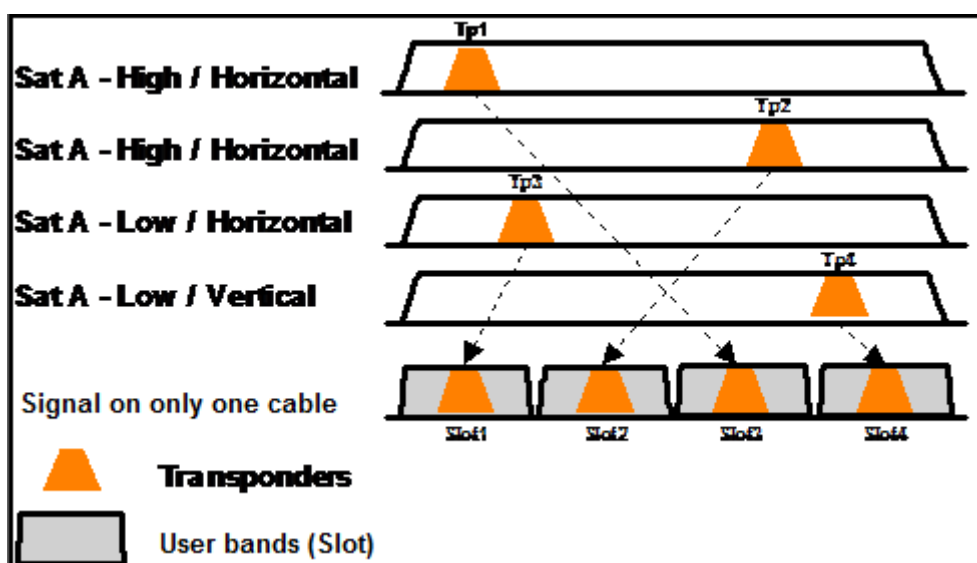



The DCSS mode has priority on all other modes DISEQC: selection polarization, selection OL, switches committed and uncommitted and positioner.

2 Modes :

SATCR : Satellite Channel Router, standard EN50494 (or SCD, Unicable, ...)

Distribution of the satellite signal with only one coaxial cable to 2, 4 or 8 different receptors.

SCD2 : Single Cable Distribution v2, standards EN50607 and EN50494 (or SCD2, Unicable II, JESS)

Distribution of the satellite signal with only one coaxial cable to a maximum of 32 different receptors.

Using Diseqc 2.0 bi-directional possibility to ask current online devices and speed up installation.

Mode choice : press DCSS



SATCR (EN50494) :



- SLOT x : active Slot choice
- CONFIG : access to each slot configuration

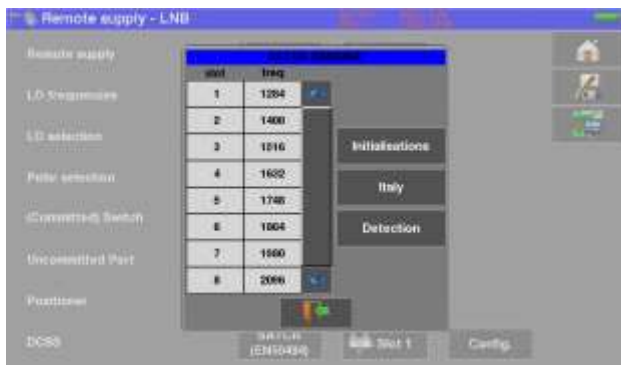

Slots list, frequencies

- INITIALISATIONS : 8 predefined slots
- TALY : 4 predefined slots for Italy
- DETECT : automatic detection of slots (spectrum detect based)

SCD2 (EN50607) :



- SLOT x : active slot choice
- CONFIG : access to each slot configuration



Slots list, frequencies, standard, PIN codes, bandwidth

- INITIALISATIONS : 32 predefined slots
- ALLOCATION : states of the 32 possible slots
- DETECT : automatic detection of slots (DISEQC2.0 based)

14.2.4.1 Influence of the DCSS on the spectrum analyzer

Frequency of the transponder visible at the center of the active slot

SatCR mode and active slot

Current polarization and band in the active slot

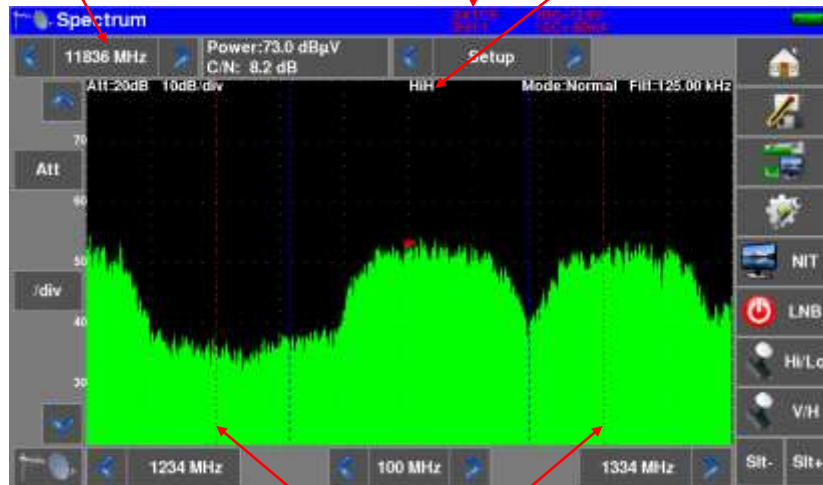

Landmarks of the user band (slot)

15 Measurement map

To access the **MEASUREMENT MAP** function, press Home then Measurement map:

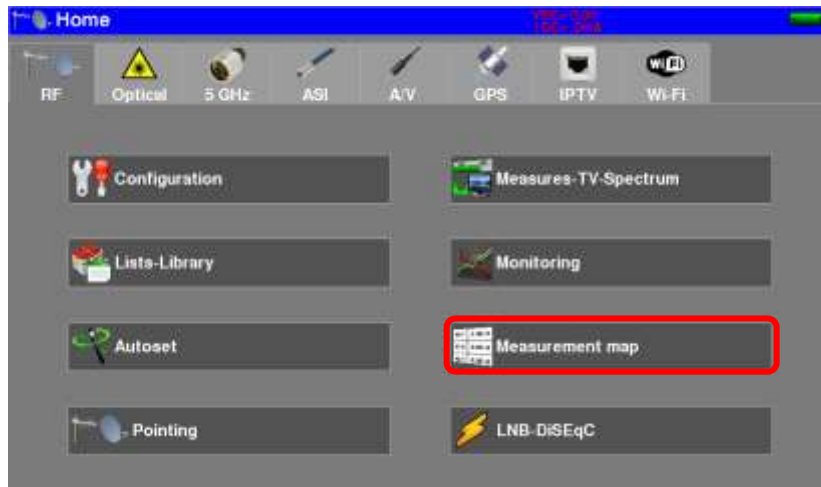

It is an automatic level and error rate measurement of the setups in the measurement list with labeling of the levels beyond tolerance.

Measurement result for channel 38 under DVB-T/H

freq.	std	RF	C/N	BERi	BERo	PER	MER	LKM
E38	DVB-T/H	56.2	>26.2	5.5E-04	<2.4E-06	<2.4E-05	31.1	10.1
E44	DVB-T/H	57.8	>27.8	2.3E-04	<2.4E-06	<2.4E-05	32.0	11.0
E59	DVB-T/H	51.9	>21.9	2.2E-03	<2.4E-06	<2.4E-05	27.0	6.0
E40	DVB-T/H	57.0	>27.8	6.8E-04	<2.4E-06	<2.4E-05	29.5	8.5
100.500	FM	67.3	>47.5					
101.300	FM	61.5	41.2					
10728 VL	DVB-S2	20.4	> 0.0	Sync?	Sync?	Sync?	---	---
10743 HL	DVB-S	25.9	> 0.0	Sync?	Sync?	Sync?	---	---

15.1 Measurements filtering

If your measurement list is mixing terrestrial/satellite/FM/... setups, you can apply a “filter” for measurements:

Press **Measure** and choose which kind of setups you want to measure



15.2 Periodic scan

You can choose to make measurements over a known time :

Press **Mode** and choose the periodic time to scan all the measurement list.

You can choose:

- mono : only one scan is made
- 0mn : the total scan starts again as soon as it is finished
- 1mn : the scan starts every minute
- 10mn : the measurement scan starts every 10 minutes
- 1h : the scan starts every hour
- 8h : the scan starts every 8 hours
- 24h : the scan starts every 24 hours





15.3 USB recording

You can save these measures on an USB stick :

Press  opens a CSV file is a stick is detected.

The save starts after browsing of all setups.
This is when the date and time are recorded.

The previous « Mode » key allows you to select the duration between two records of the list.

	<p>BERi, BERO et PER are generic terms (frequently used)</p> <p>BERi = BER in = inner BER first BER treated by the demodulator (BER channel, CBER, LDPC)</p> <p>BERo = BER out = outer BER last BER treated by the demodulator (BER Viterbi, VBER, BCH)</p> <p>PER = packet error rate non-proofread packet, lost packet, wrong packet (UNC, PER)</p>
	<p>Important: A bargraph under the Measurement map allows you to track the evolution of the scan.</p> <p>The background color of this bargraph shows you that a complete scan has been made (for a save, for example):</p> <ul style="list-style-type: none"> - red: the measurement map has not been totally scanned yet - green: the measurement map has been totally scanned
	<p><u>In case of mixed measurement map (terrestrial+satellite)</u>, the satellite remote power supply has priority (the terrestrial remote power supply is ignored).</p>

15.4 Values beyond tolerance

The digital values are colored according to the **Thresholds** before decision

- **red** for values less than **Threshold min**
- **orange** for values more than **Threshold max**

freq.	std	RF	C/N	BERi	BERo	PER	MER	LKM
E38	DVB-T/H	56.2	>26.2	5.5E-04	<2.4E-06	<2.4E-05	31.1	10.1
E44	DVB-T/H	57.8	>27.8	2.3E-04	<2.4E-06	<2.4E-05	32.0	11.0
E58	DVB-T/H	51.9	>21.9	2.2E-03	<2.4E-06	<2.4E-05	27.0	6.0
E40	DVB-T/H	57.8	>27.8	6.8E-04	<2.4E-06	<2.4E-05	29.5	8.5
100.500	FM	57.3	>47.5					
101.300	FM	61.5	41.2					
10729 VL	DVB-S2	20.4	> 0.0	Sync?	Sync?	Sync?	--	--
10743 HL	DVB-S	25.9	> 0.0	Sync?	Sync?	Sync?	--	--

15.5 Graphics

To switch to graphic mode, press



In graphic mode, you can see levels.

The graph is:

- **red** for values less than **Threshold min**
- **orange** for values higher than **Threshold max**
- **green** for values **between both thresholds**

You can measurement the difference “Tilt” between the levels of two setups thanks to the Ref and Curs cursors :



You may graphically select a setup to know its name, its level measurement : press directly on the graphic bar you want:



16 Constellation

The graphic display of the Constellation is possible on the standards:

- DVB-T/T2
- DVB-C/C2
- DVB-S/S2, DSS

In the "Measures-TV-Spectrum" page, press the key

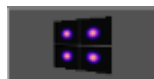

The appliance displays the **Constellation** of the current signal.

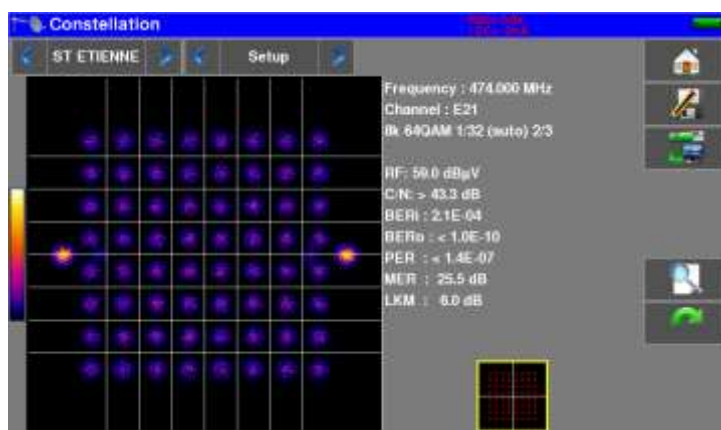

On this page, you can "zoom" on one of these quadrants by pressing



You can change the display of the quadrant by pressing



On this page, there is a template (with ideal constellation spots).

On this template, there is a yellow frame that shows where to zoom on the constellation.

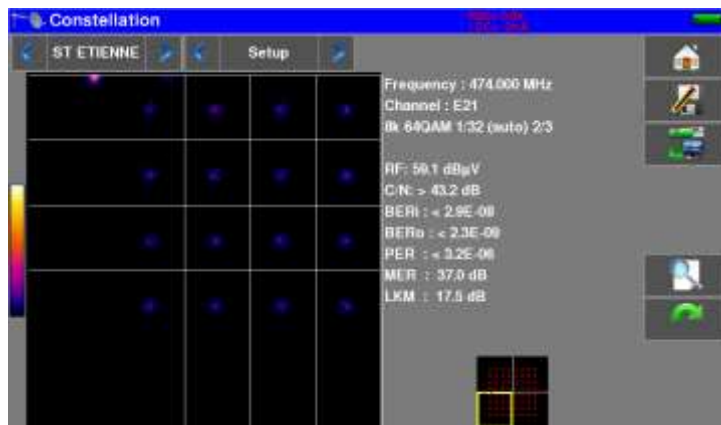

The information displayed on the right of the **Constellation diagram** are :

- current frequency
- channel number (terrestrial only)
- modulation, constellation, symbol rate
- RF power
- C/N ratio
- bit error rate
- MER
- LKM ('link margin', noise margin)

17 Echo / Guard interval

These measures are available with one of these standards :

- DVB-T/T2
- DVB-C2

In the "Measures-TV-Spectrum" page, press the key





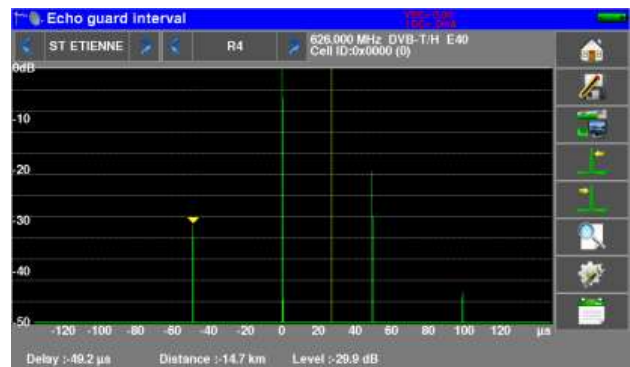

Signal without echo



Signal with echoes and pre-echoes

Pressing  changes the horizontal scale (distance).

Horizontal scale can be set in µs, km or miles by pressing 

Moving measurement arrow  can be done by screen touch, or by automatic search keys  and 

The end of the guard interval is displayed with a **yellow line**.

Pressing  displays simultaneously echoes graphic and array of the highest echoes detected (first 10th) :

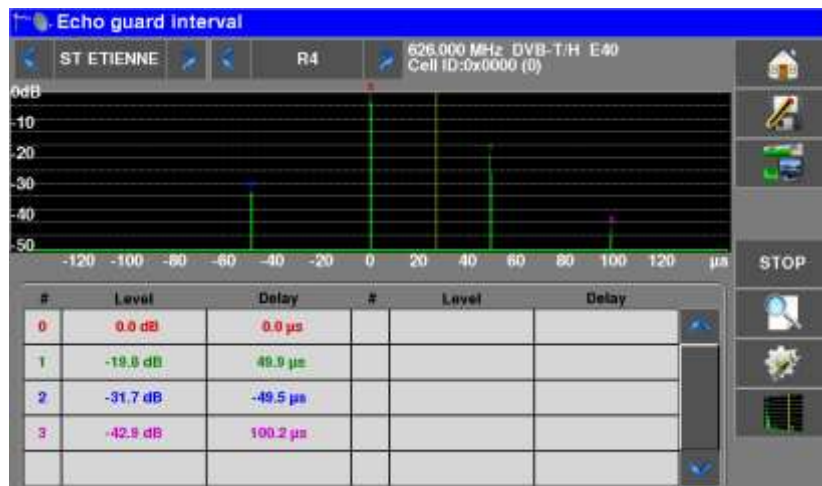

Press the key  to stop the scan and hold the results.

Reminder :

Remember: In terrestrial TV broadcasting, the received signal on the antenna comes from several possible ways: the **echoes**.

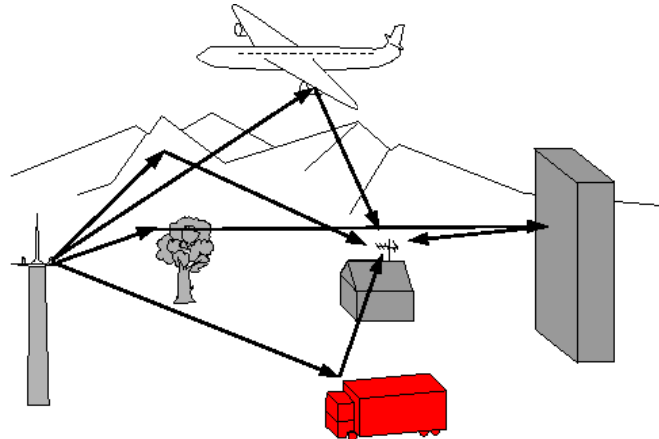

In digital TV DVB-T/H and DVB-T2, these echoes may help or degrade the image according to the time delay between the various signals that reach the antenna.

The broadcasting norms DVB-T and DVB-T2 define a modulation parameter called "**guard interval**" where echoes won't disturb the reception.

The transmission of digital data (**Symbol**) is interrupted during the **guard interval**.

A delayed (or advanced) symbol of any **shorter** duration than the guard interval will not disturb the reception.

A delayed (or advanced) symbol of any **longer** duration than the guard interval will disturb the reception.

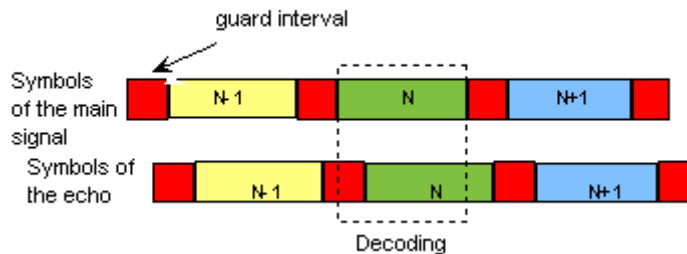

You have to reduce the level of reception of the echoes by orienting the antenna or by selecting a more directive antenna.

The **Echo** function of the appliance enables you to display possible **echoes** that disturb the received signal.

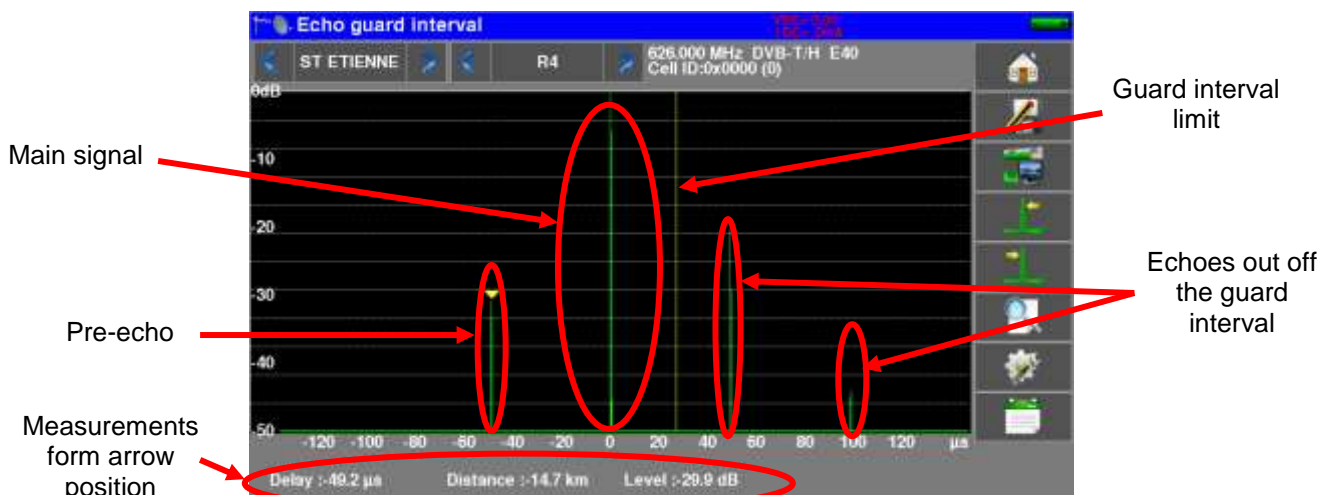

Relative amplitude in dB and delay in μs (distance in km) from the main signal (pulse #0) can be measured.

The **yellow line** represents the end of the guard interval.

Echoes and pre-echoes (pulses) above the yellow line disturb the signal and must be reduced as much as possible.

The echoes (pulses) beyond this line disturb the reception and must be as weak as possible.



Attention: a high amplitude echo pulse within the guard interval will also disturb the signal quality.

18 MER/Carrier

These measures are available with one of these standards :

- DVB-T/T2
- DVB-C2

In the "Measures-TV-Spectrum" page, press the key

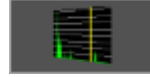

The instrument will display MER per carrier and the MER of the whole signal.



Perfect signal

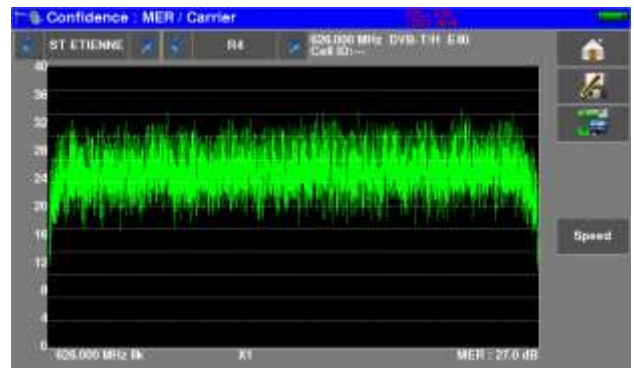

Highly disturbed signal

The MER of each carrier is displayed, and each « hole » represents a potential problem on the signal or a spurious.

A real signal is fluctuating a little bit. This must be taken into account during analysis:

In this page the "Speed" key defines the sampling of displayed carriers and MER:

	X1	: all carriers are sampled and used
	X2	: one over two
	X4	: one over four
	X8	: one over eight
	X16	: one over 16
	Max	: max speed : 624 carriers are measured

19 Shoulder Attenuation

These measures are available with one of these standards :

- DVB-T/T2

In the "Measures-TV-Spectrum" page, press the key

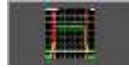

The device displays on this page the measurement of the 'Shoulder Attenuation' of the current signal.

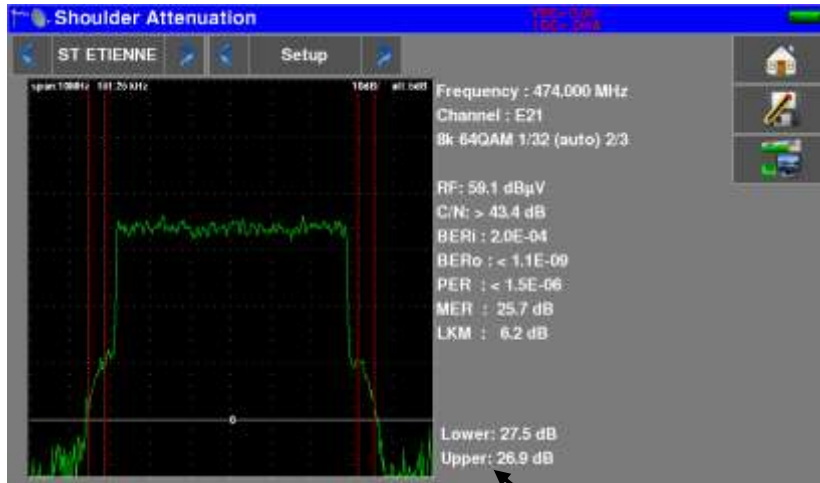

Value of the 'Shoulders' measured:

- 'Lower': measurement of lower frequency side of the channel
- 'Upper': measurement of high frequency side of the channel

This measure is defined by ETR290 :

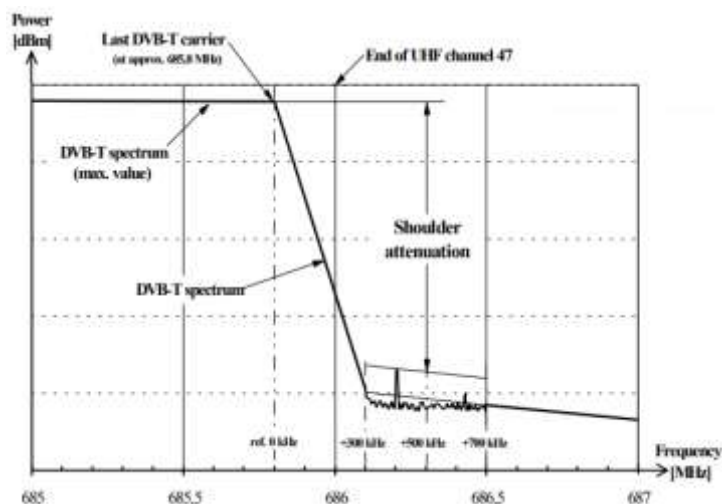



20 ASI function

The input or the output of the MPEG digital video signal is made according to the ASI standard ("asynchronous serial interface").

This is a serial transmission, asynchronous (without clock) 270MHz on coaxial cable to input or output a digital modulator or an MPEG frame analyzer for example.

ASI input

Pressing the "HOME" key  and then the tab "ASI"  allows to access the ASI IN entry

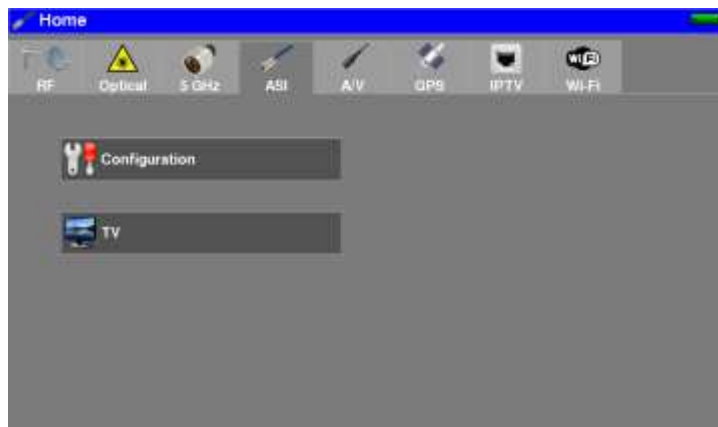

The state of the interface is displayed on the TV image:

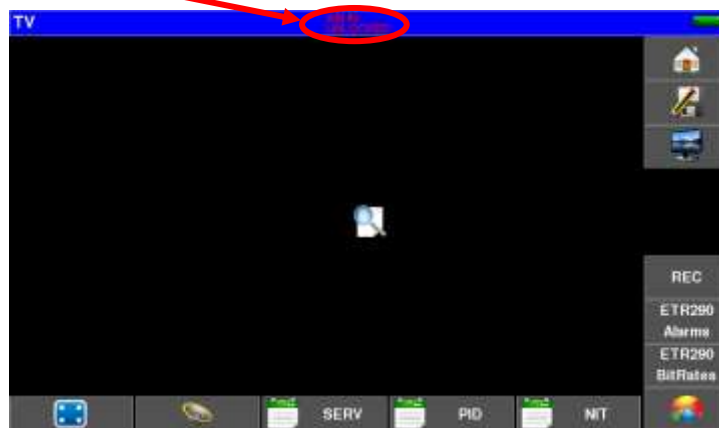

Indications:

- ASI IN: TV picture from ASI input
- UNLOCKED / LOCKED: status of the ASI interface (unlocked / locked)

The ETR290 analysis functions are available on this ASI input.



ASI output

The device continuously transmits on the output **ASI OUT** the multiplex coming from:

- the RF input on a synchronized digital channel
- optical input on a synchronized digital channel
- the input ASI IN if the interface is synchronized

21 A/V function (external video)

The device can display on its screen, the TV picture from the A / V input (jack, see section 3.2)

Pressing the "HOME" key  and then the tab "A/V"  allows to access to input **AV external video** :

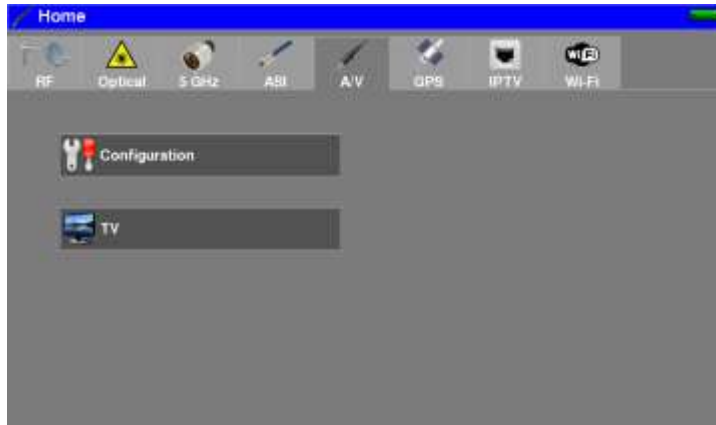

The state of the interface is displayed on the TV image:

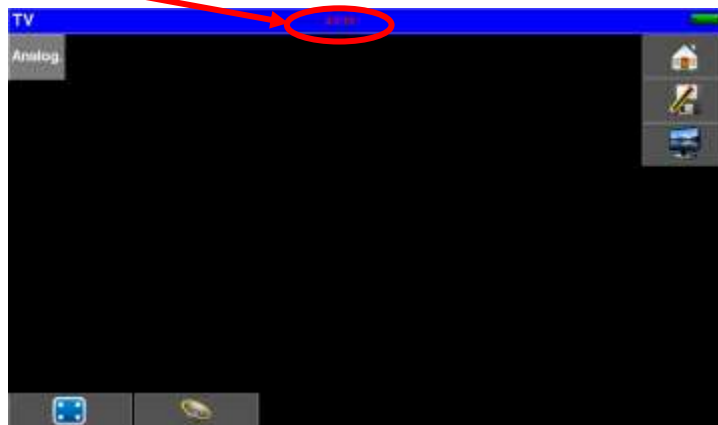

Indications:

- AV IN: TV picture from external A / V input (jack)

Connection cable: accessory available from SEFRAM



RCA yellow : video
RCA white : left audio
RCA red : right audio



22 GPS

To access the GPS functions, press the "HOME" key  and then the "GPS" tab 



3 functions are available :

- MAPPING function to create a map with positions and RF measurements
- VIEW function to graphically display all GPS satellites in view
- LOG function to record the number of GPS satellites used for positioning

22.1 VIEW function

The appliance starts searching several satellites to find its own position with accuracy:

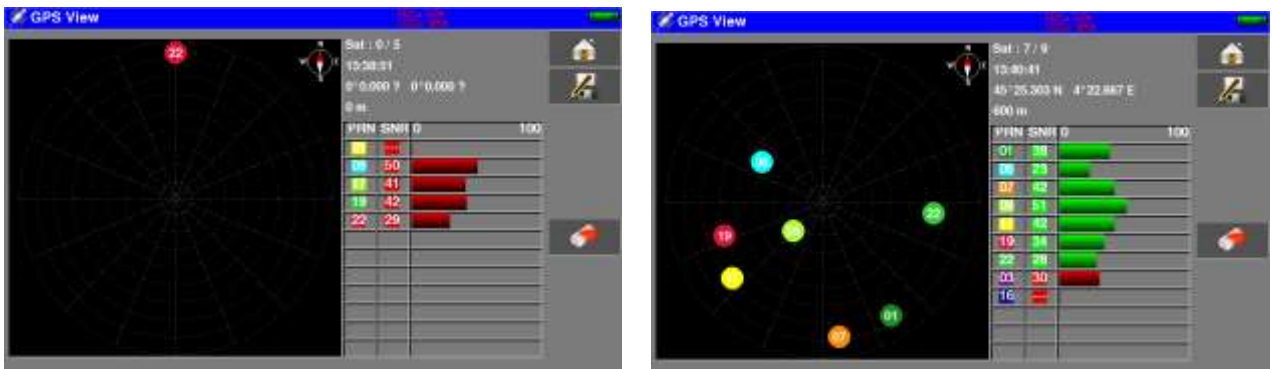

When satellites have been found, they appear on the pattern; non-locked satellites blink.

The data are:

- the number of locked satellites on the total possible satellites
- the UTC time
- the latitude and longitude of your place
- a table including
 - the PRN (Pseudorandom Noise), the identification label of the satellites
 - the SNR (Signal/Noise Ratio), signal quality reception (0% = no signal)
 - the graphical representation of the SRN.

22.2 LOG function

This function allows you to register the number of locked satellites as a function of time.

The key below selects the acquisition time (10 mn, 60mn, 8 h, 24 h or 7 days)

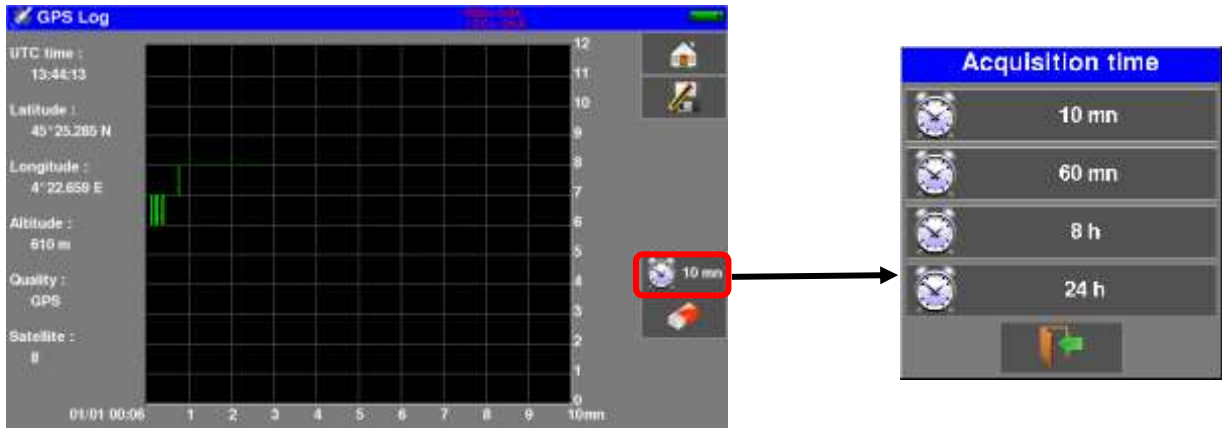

The « Init » key  initializes the record and the « reset » key resets then satellite search.

22.3 MAPPING function

This function is made for superimpose on a map, all measurements level/BER of RF signal received.

This function is used to create a file *.GPS inside internal memory of your appliance, with for each recorded point :

- coordinates (latitude, longitude)
 - level/BER measurements
- for 1 setup
- or
- for setups 1 to 11 of the Measurement Map

You can then, export this memory *.GPS to a file *.KML on an USB memory stick, and use a GIS mapping software (Geographical Information Software). For example you can use Google Earth or Google Maps.



GPS status :

- UTC time
- coordinates (latitude, longitude)
- altitude
- satellites used by the GPS module

Measurements : 1 setup or setups 1 to 11st from Measurement Map (measurement setup by setup)
RF – C/N – BERi – BERo – PER – MER – LKM

All the configuration is available from key



- Measure type :
 - Level/BER/MER : measurements of current Setup
 - Measurement Map : setups 1 to 11 from Measurement Map
- Acquisition :
 - Manual : one record each keypressed
 - Timer : one record each timer elapsed (from 10s to 3600s repetitive acquisition)
 - Distance : one record over distance move (acquisition triggered by distance from 10 to 10000m)

22.3.1 Recording a file

At the beginning, the appliance is looking of satellites to make good positioning.

The “Status GPS” display the GPS coordinates sended by GPS hardware.

The RF measurements “Level/BER/MER” or “Measurement Map’ display the associated measurement.

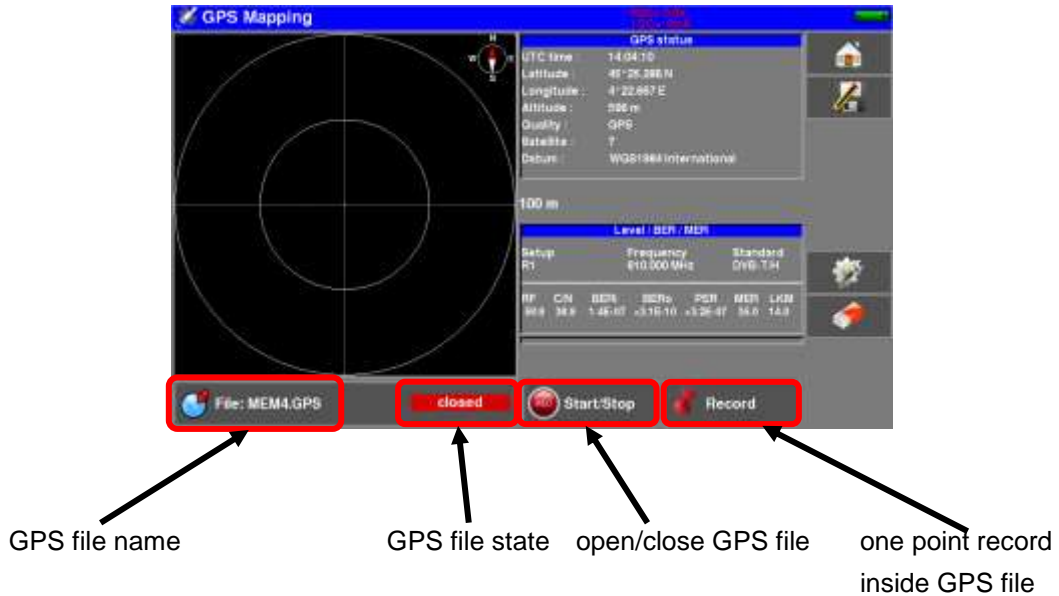

Once configurated (Measurement type, Acquisition mode), give a name to the GPS file (the appliance propose you a default name MEM0.GPS)

Then :

Start : opens the GPS file to start recording

The appliance record measurements according to parameters (manual/timer/distance) in the file

Stop : closes the GPS file to stop recording

	<ul style="list-style-type: none">- the file can not be opened if “No Positioning” (less than 3 GPS satellites)- nevertheless Acquisition Mode, the key ‘Record’ force recording- if measurement total time is higher than timer, measurement time will be the repetitive period- outputting CARTOGRAPHY function will closed the file- you can not append a file previously closed- if positioning if lost, recording is suspended (file not closed)- the file is always created, even it is not closed (power supply failure for example)- if maximum number of records is reached (1000 points), file is automatically closed
---	---

The graphical zone represents the display of the current coordinates from the original position.
Press this 'target' zone to change scale and reset the display.

22.3.2 Export and cartography

After creating the *.GPS file on your device, you can export it to a USB stick:

- in CSV format for display in a spreadsheet
- in KML format compatible with most mapping software ("Google Earth" and "Google Maps" for example)

To export your file to "Google Earth" :

- Configuration -> Memories
- insert an USB memory stick
- choose your *.GPS file
- press "Save (KML->USB)"



Data recorded in the file are :

- file name, date and time
- the setup or all setups measures (frequency, standard, thresholds)

And for each recorded point :

- date
- time
- latitude
- longitude
- number of satellites used
- RF measurement Level/BER/MER for each setup

23 Optical Fiber function

To access the "Fiber Optic" function, press the "HOME" key



and then the tab "Optical"



The optical option allows measurements to be made in different installation configurations:

- in fiber satellite reception (optical fiber LNB output)
- reception on a dish with an RF output up to 5.450 GHz
- behind a satellite / terrestrial fiber coupler

The option allows you to:

- measure the optical power on the fiber
- convert the optical signal into an RF signal to retrieve the antenna signals

23.1 What you should know

A few notions are required before considering the use of optical fibers.

23.1.1 Optical fiber

Optical fibers are sometimes used for satellite reception. This technology enables makes it possible to transmit a signal further with less loss and with a larger bandwidth.

The optical fiber is a waveguide, generally made of glass, that enables the transmission of the optical signal. Optical fibers are made of a core, a cladding and at least one protection. There are two kinds of optical fibers: multimode and single-mode.

The difference is the size of the core inside the fiber: 9 μ m diameter for single-mode, 50 μ m for multimode.

Multimode is less expensive, while single-mode induces less losses.

For satellite reception, only single-mode fibers are used.

Sectional view of an optical fiber:

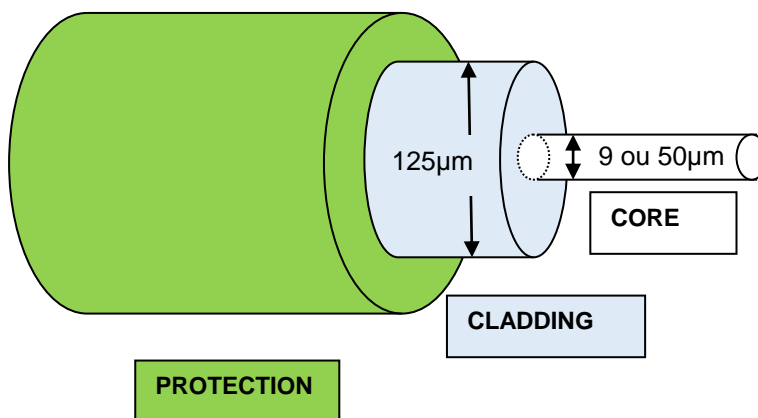

Warning: Optical fibers are fragile and must not be constrained, bent or folded: the core may be damaged or even broken, which results in a partial or total loss of the signal.

23.1.2 Connectors

Like for RF, connectors are very important and their selection has consequences on the quality of the received signal.

With optical fibers, there are several kinds of connectors according to the type of fiber (single-mode or multimode) and to the selected connection.

Thus, there are plastic SC connector for indoor uses and metal FC connectors for indoor and outdoor uses.

Similarly, there are various « polishings » of the fiber core:



- straight PC (Physical Contact) or SPC (Super Physical Contact) or UPC (Ultra Physical Contact)
- angled APC (Angled Physical Contact)

APC polishing generates advantageously less losses by reflection. APC connectors are recognizable thanks to their green color.

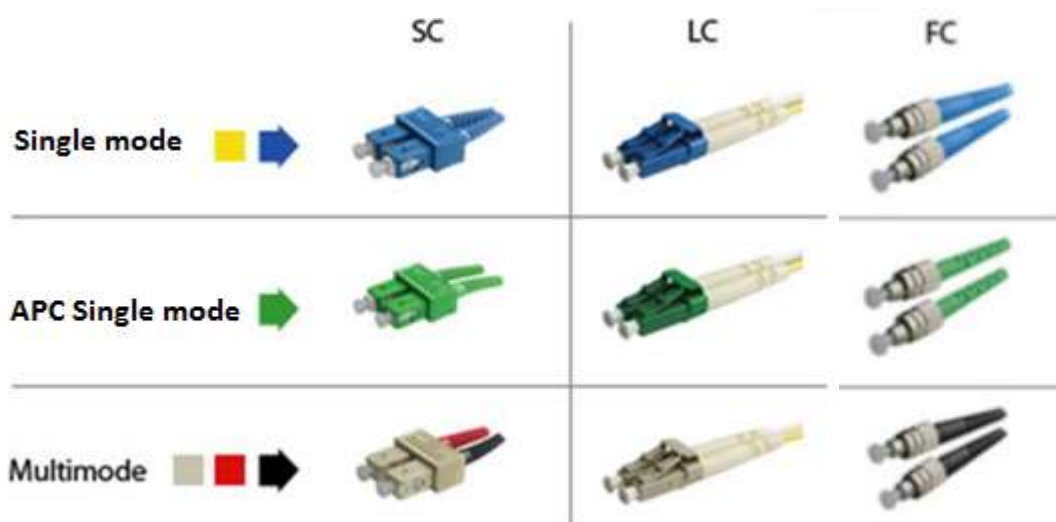
If you plug an APC connector to a non-APC connector, in addition to an increased risk of **damaging the fiber**, there will be **automatically** a **4dB** decrease of the optical level, which means **8dB** for RF. Thus, you will have to take great care of the connections and the types of connectors for your installation.



On the measurement device, the connector is **FC APC**, but a jumper cable is provided with the appliance to switch from **FC APC** to **FC PC**, **FC SPC** or **FC UPC**.

	Warning: Before connecting a fiber, it is compulsory to clean both connectors with a compressed air spray. Never use clothes, alcohol, water or any other liquid or solvent.
	Warning: The wavelengths inside the optical fibers are generated by lasers; you cannot see them , but they are particularly dangerous for your eyes and may lead to irreversible damages . Thus, you must be very careful when manipulating these fibers (i.e. do not watch inside a connector to the LNB when linked to the live head). The measurement device has no optical source: it does not emit any light.

23.2 Satellite reception

In standard satellite reception (KU), the LNB transforms the Ku frequency of the satellite into a BIS frequency into 4 frequency bands:

Vertical Low (VL) - Vertical High (VH) - Horizontal Low (HL) - Horizontal High (HH)

These bands are automatically selected by the satellite receiver with 0 / 22kHz, 13 / 18V or Diseqc controls.

In optical fiber satellite reception, the LNB transforms the satellite's Ku frequency into a single frequency band from 950MHz to 5450MHz, before converting it to light using a laser.

The "special optical fiber" receiver is responsible for converting the light into an RF signal, and reconstructing the 4 conventional reception bands: VL, VH, HL, HH; the use of the optical fiber is therefore transparent.

Attention : the LNB is powered independently.

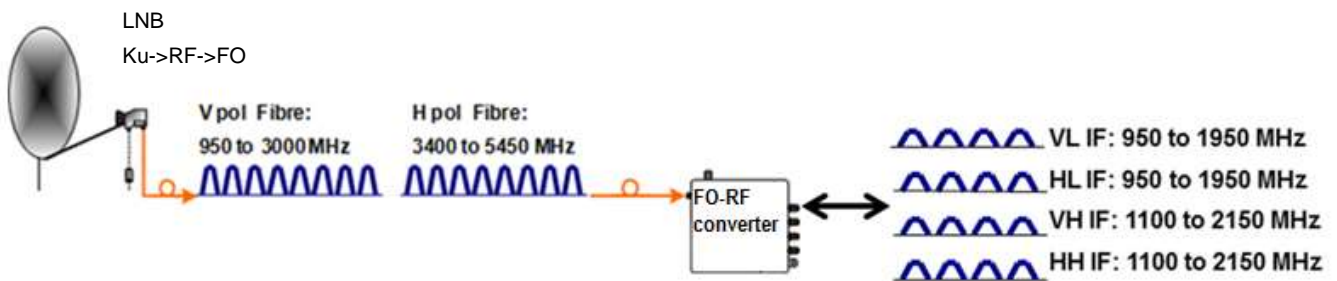

The field meter replaces the Optical-> RF converter and recreates the conventional satellite bands.

Remove the protective cap from the FC APC optical socket, if necessary use the supplied jumper, connect the optical fiber of your dish to this socket.

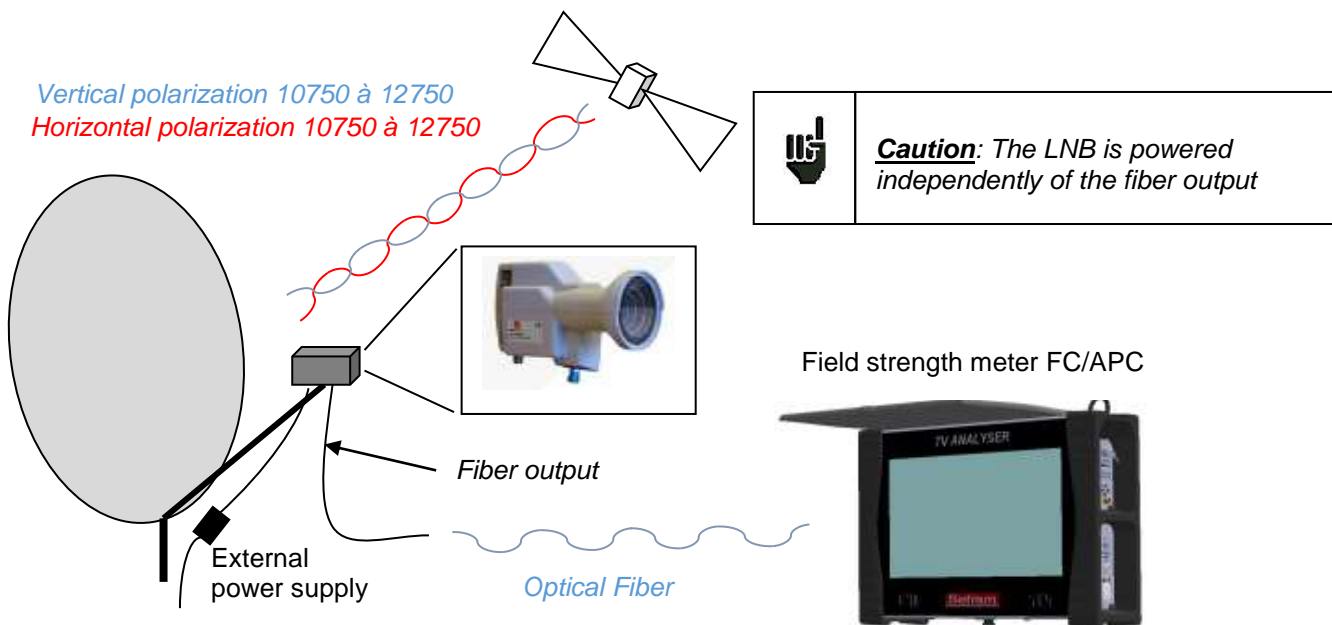

On the device, the HOME page provides access to all measurements:

- identical to the RF input (Pointing, Spectrum, Measurements / TV, Monitoring, Measurement Plan ...)
- choice of working wavelength
- measurement of optical power seen on the fiber

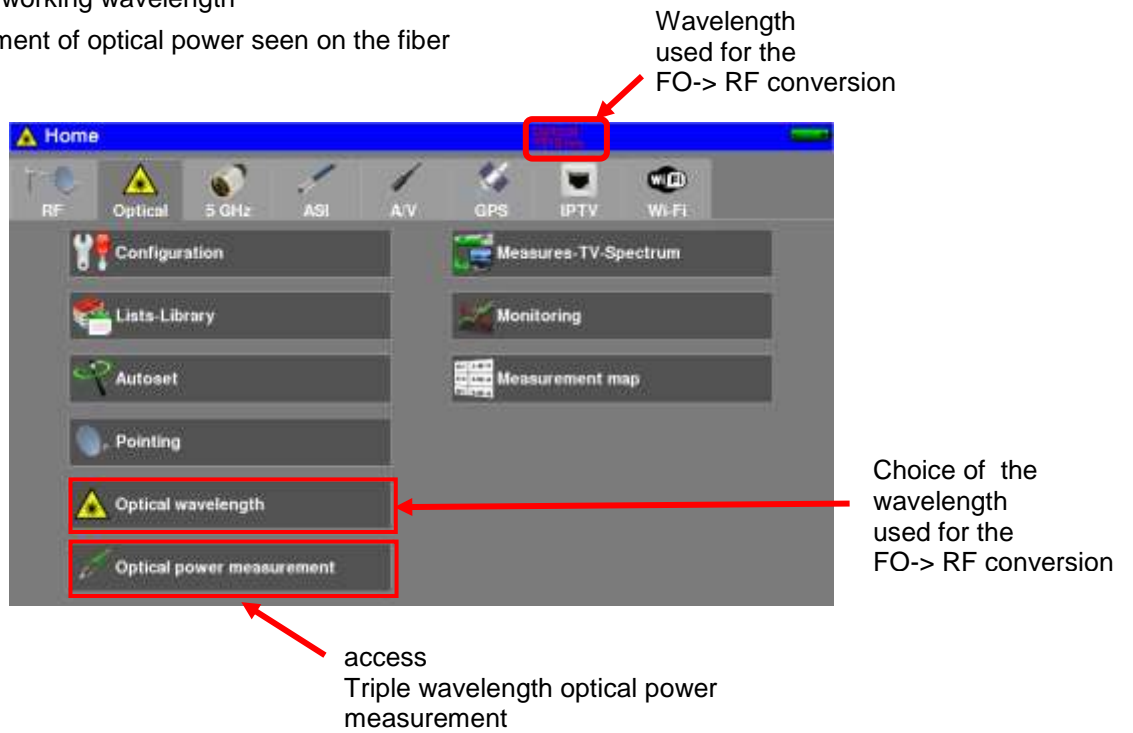

23.3 Wavelengths

Optical fiber is used at several wavelengths depending on the attenuation / distance curve:

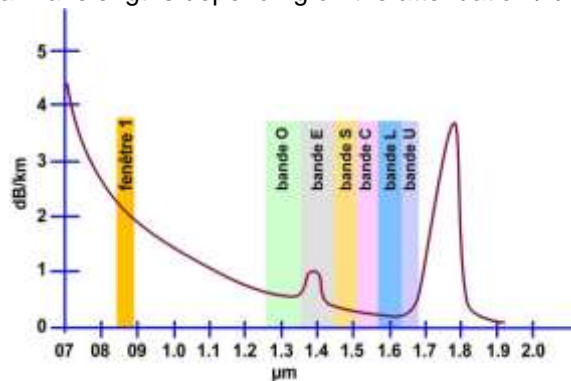

The device can operate at 3 wavelengths: 1310nm, 1490nm or 1550nm
Choose the wavelength corresponding to your installation:



In satellite reception we mainly use the wavelength: 1310nm (check this information on the LNB to be installed)

You can then point your parable (see chapter 2.2.3 installation of a parable)

23.4 Optical Power measurement

You can choose to measure a single wavelength, or 2, or all 3 simultaneously:

Choice of measured wavelengths

Display unit: dB, mW or dBm

Reference points for each wavelength

Optical Power Meters:
Violet: 1310nm
Yellow: 1490nm
Blue: 1550nm

Optical power for each wavelength

Graphical recording of optical power measurements.

Recording time: 10mn, 60mn, 8h or 24h

Measurement of insertion losses:

Make a first measurement at the top of your installation:
press the Reference of the desired wavelength.

The device keeps this measurement as Reference and automatically switches to dB.

Take your measurements at any point in your installation to check the losses on the optical signal.



Warning :

- Optical Power measurement between -50 / +10 dBm
- Optical conversion -> RF between -12 / -3 dBm

Use an external optical attenuator if necessary.

24 5GHz input

There are also LNB satellites with an output frequency of up to 5.450GHz.

This type of LNB converts the Ku frequency of the satellite into a single frequency band from 950MHz to 5450MHz.

The field meter has an input dedicated to this type of LNB: "5GHz".

Press the "HOME" key  and then the tab 



You then have access to the same measures as with the conventional RF input: Pointing, Spectrum, Measurements / TV, Monitoring, Measurement Plan ...

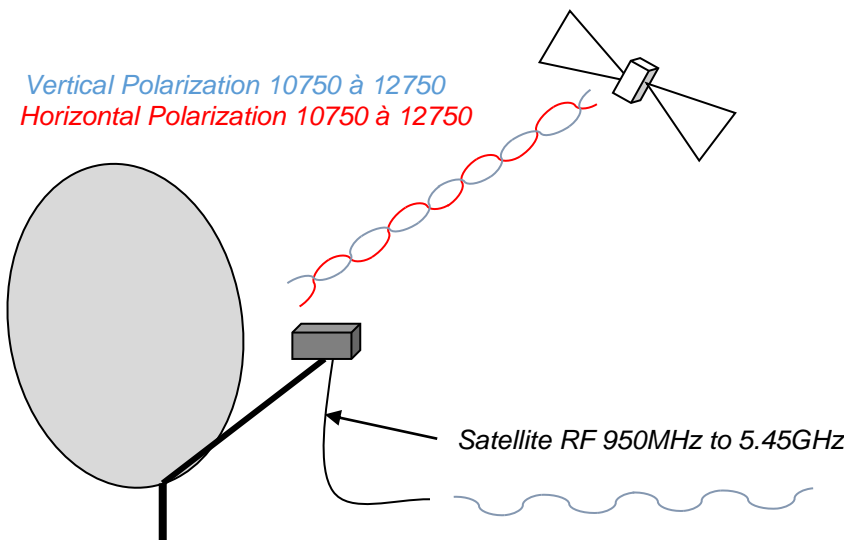

Caution: a 5.45GHz LNB must be powered by 6.2V, especially not feed it with the remote power supply of the RF input (13 / 18V), risk of destruction of the LNB.



Caution: working at 5,450GHz in RF requires precautions (quality of the connectors and weak cable length) to not have a too deteriorated signal.

To use the 5GHz measurement input, it is necessary to configure it; Press on



From this menu you can activate the 6.2V remote power supply of your 5.45GHz LNB, and choose the band you want to work on:

- Auto which is the complete Terrestrial band (50 to 900MHz) and Sat (900 to 5450MHz)
- Terrestrial band only (50 to 900MHz)
- Vertical low sat alone band (900 to 1950MHz)
- High vertical sat band alone (1950 to 3000MHz)
- Low horizontal sat band alone (3400 to 4400MHz)
- High horizontal sat band only (4400 to 5400MHz)

The interest is to be able to "isolate" a band to be able to make investigations during the search for breakdown.

25 WIFI

Press the "HOME" key



and then the tab



Connect the Wi-Fi antenna supplied on the SMA connector.

You can measure the RF level received of your Wi-Fi network, or display the list of Wi-Fi networks received by your appliance, with text display (by SSID) and graphical display (Histogram).



- **SSID Service Set Identifier** : network identifier
- **Frequency** : Wi-Fi frequency of your network
- **Channel** : Wi-Fi channel of your network
- **Mac** : MAC address of your network

The screenshot shows the 'Measure Wi-Fi' screen with a table of detected networks. The table has four columns: SSID, Frequency, Channel, and PWR. The data is as follows:

SSID	Frequency	Channel	PWR
TRENDnet1670K	2412000 kHz	ch-1	-40 dBm
asfran_wi	2462000 kHz	ch-11	-75 dBm
wi_invite	2462000 kHz	ch-11	-75 dBm

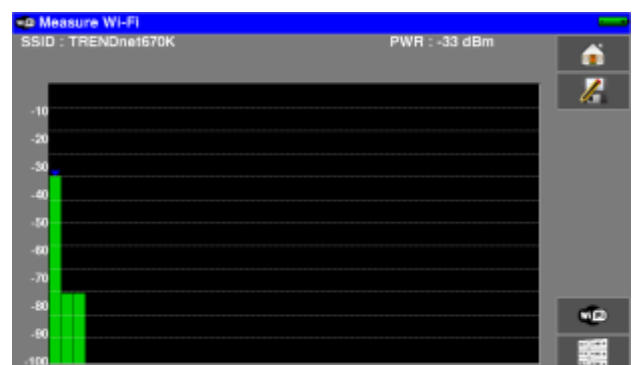

26 IPTV function

Press the "HOME" key  and then the tab



in developpement...

27 Save

Pressing

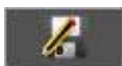

opens a window (here, on the Measurement Map page):



In this window, you can :

- save the current measurement parameters to the active list (frequency, standard, ...)
- make a screen shot to a USB stick under BMP format
- make a save into internal memory.

You can rename the save file (see chapter [Man-machine interface](#)).

The default name of the save is **MEM(X+1)**
(**X** is the number of saves in the appliance).

You will be suggested a save into internal memory only in the **Spectrum, Measurements, Constellation, Guard interval, MER/Carrier** and **Measurement map** pages.



After transfer, you will be able to use the saved measures to create measurement reports on your computer (see paragraph “Memories” more details).

By pressing a line of the table, you open a window:

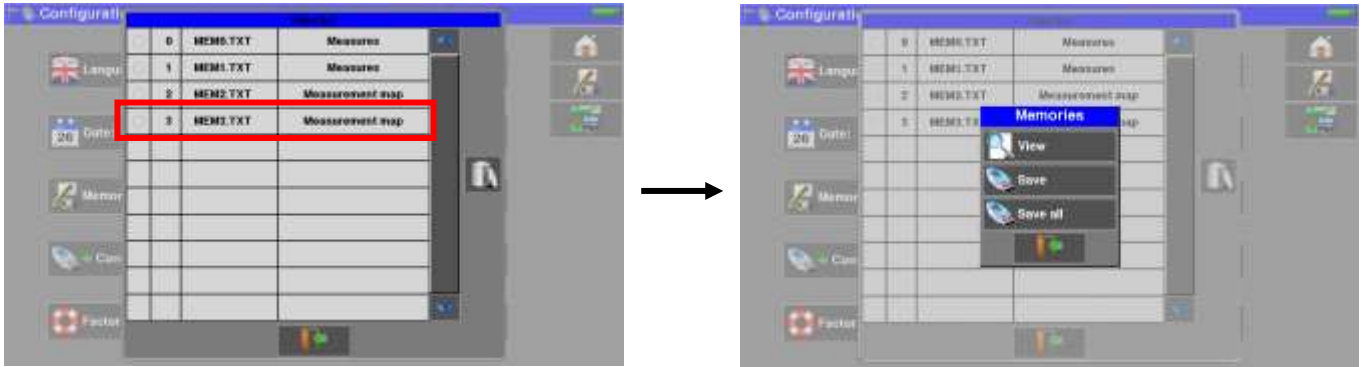

You can then view the contents of this memory, or export it to an USB memory stick. From this menu you can also export to a USB key all the contents of the memory.

28.3.1 View

This key allows the display of the content of the file:



28.3.2 Save

Allows you to export the file to the USB stick under BMP or CSV format.

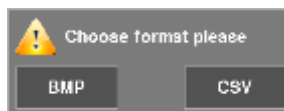

BMP : allows the export of the file to the USB memory key in BMP format (uncompressed graphic) useful to import on a PC graphics in a report.

Here is the BMP file of the previously displayed DVB-T/H channel, edited on PC to have the spectrum full screen.

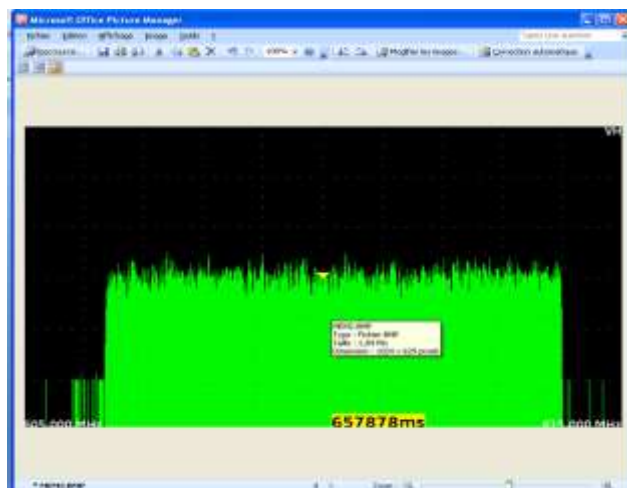

CSV : allows you to export the file to the USB stick under CSV format (text file by columns separated with semicolons); it is useful to analyze values in a spreadsheet.

Here is the spectrum hereabove with a curve under EXCEL™.

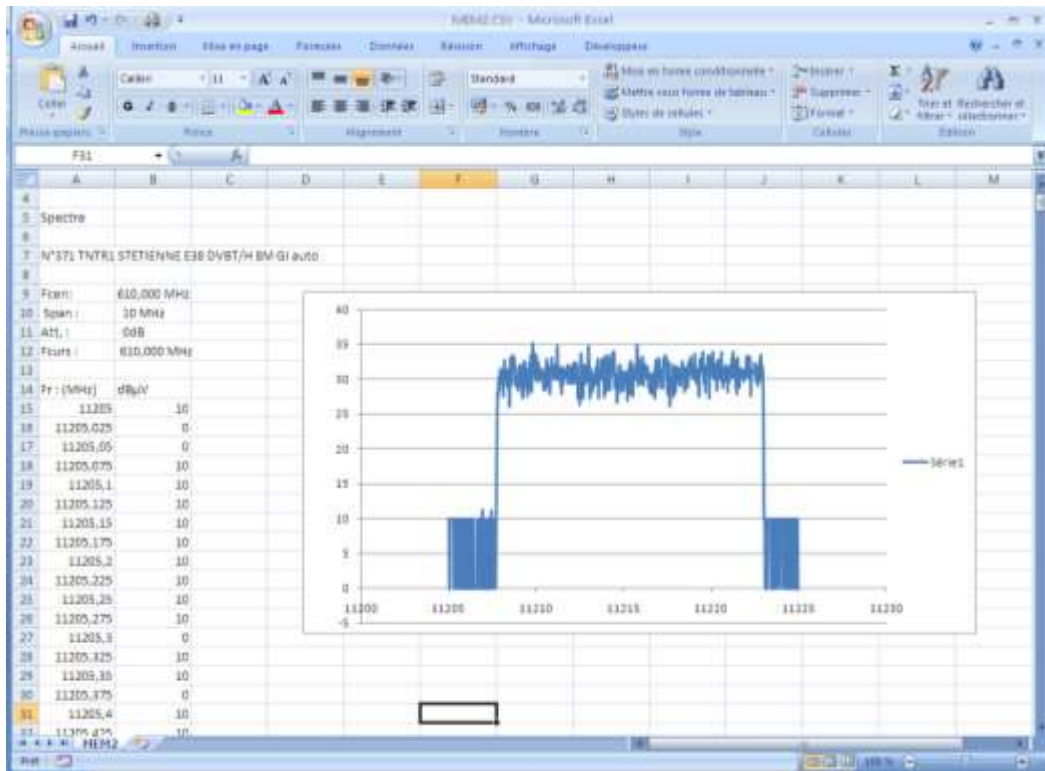

28.3.3 Save all

Records all files from the appliance under BMP format or CSV format, saved into separated directories :

- LEVEL for the level measurements
- MAP for the measurement maps
- SPECTRUM for the spectrum measurements
- BER-MER for the error rate measurements
- CONST for the constellations
- ECHO for the echoes.

28.4 Adjustment



28.4.1 Measurement unit

This key allows you to select the measurement unit of the appliance:

- **dBµV:** 0 dBµV corresponds to 1 µV
- **dBmV:** 0 dBmV corresponds to 1 mV
- **dBm:** 0 dBm corresponds to 274 mV: 1 mW with a 75 Ω impedance.

28.4.2 Impedance

Input impedance of the device:

- 75 ohms
- 50 ohms

28.4.3 Bip

Key sound and Antenna Pointing sound ; from 0 to 100%

28.4.4 LCD

Brightness of the screen; from 0 to 100%

	<p>Attention: a Screen Saver will be displayed 2 hours after last time using the device.</p>
---	---

28.4.5 IP address

Entering the characteristics of the Ethernet interface of the device: IP address, mask, gateway



28.4.6 Password

You can create a password that will be required at each start-up.
It is a security feature in case someone stole your material.

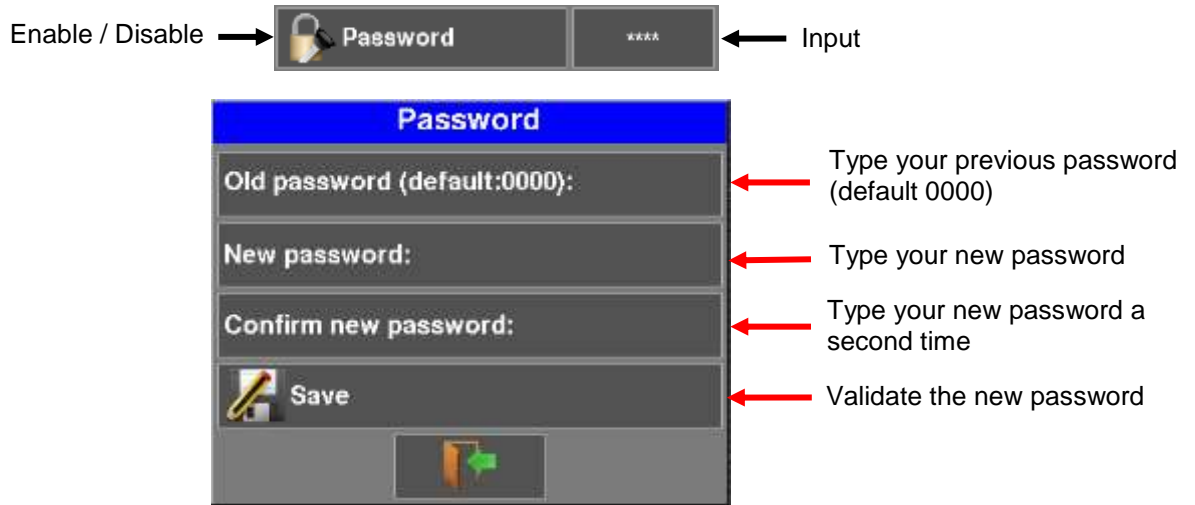

At each start-up, a buttons shall show up on the welcoming page; press it and enter your new password:



If the code is right, the appliance will start (there is no limit to the number of trials).

It is mandatory to register your instrument and the password to recover a lost password from SEFRAM (please use the template supplied on the CD-ROM)

	<p>Attention : if you have lost your password please contact the technical support support@sefram.fr</p>
---	--

28.4.7 Background

This key allows you to change the background of graphs between **black**, **white** and **grey** (spectrum, constellation...)

This function is useful to spare ink when printing reports with a printer.

28.5 Configuration

You can EXPORT the configuration of the appliance to an USB stick, or you can IMPORT a new configuration from an USB stick.

The configuration of the appliance results from 3 files :

- One file SAT.CSV for Satellite Dish Pointing (see “[Pointing antennas](#)”)
- One file TER.CSV for Terrestrial Antenna Pointing (see “[Pointing antennas](#)”)
- One file CONF.CSV including up to 1000 setups and 20 measurement lists, 50 lines each (see “[Setup library](#)” and “[Measurement lists](#)”)

You can copy these files to the **root** of an USB memory stick.

Then, the USB memory stick must be connected to the appliance.

You only need to exchange these files between your appliance and the USB stick to update your measurement configurations.

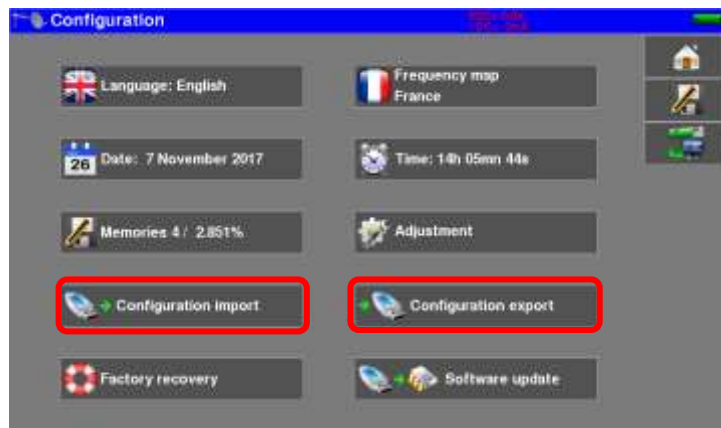

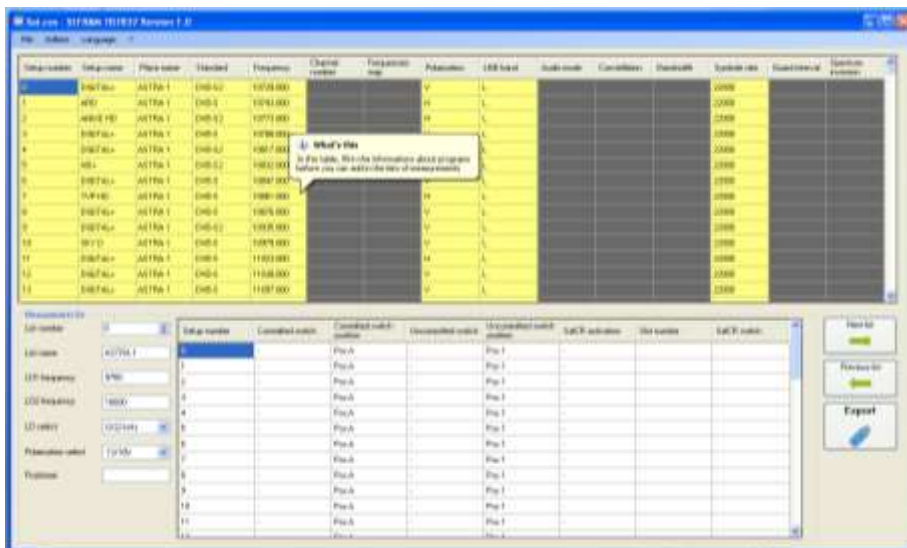

It is possible to update the configuration of the device using the PC software TR7837 available free of charge on our website.

Embedded Help will be useful for each work.



 If no CSV file is present on the USB memory stick, only the older configuration of the appliance will be saved.

 You don't have to copy all files to the USB memory stick; i.e. if only the Check Sat must be changed, you only have to copy SAT.CSV on your stick.

 You can move the older CSV files from the CONF directory to the root of the USB stick to transfer the configuration of an appliance to another.

28.6 Update

See chapter "[Software update](#)" for more details.

28.7 Factory recovery

A complete set-up of the appliance under its FACTORY configuration, with confirmation.

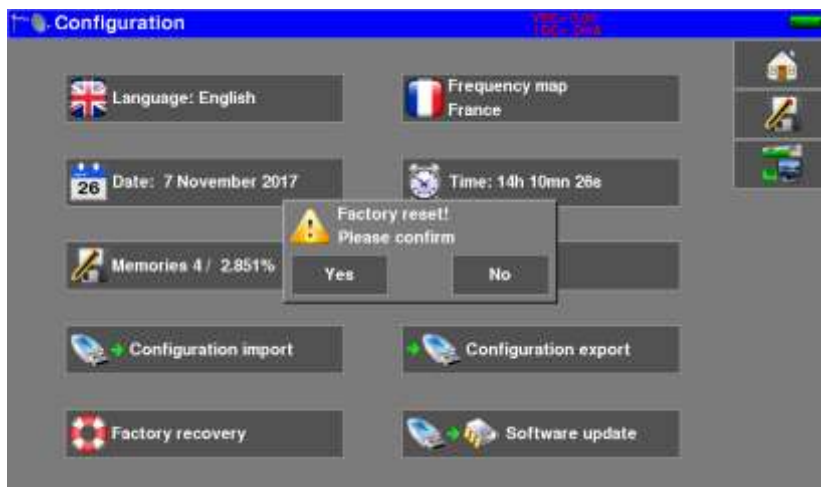

 **Attention:** In case of factory recovery, you **lose**:

- the setup library
- the measurement lists.

29 Software update



Caution: Take care that the remaining battery life is sufficient (> 30%), else plug the appliance on the mains with the provided adapter.

You can easily update the software to get new functionalities.
The update requires an USB stick.

To achieve the update:

- Download the update file **788X_VX.X zip file** on our website (www.sefram.fr)
- Insert a USB stick on your PC
- Unzip the file onto the root of the memory stick
- Pull the USB stick off from your computer
- Turn your appliance on
- Insert the USB stick into the connector of the appliance.

- Go to Configuration page, press



After 10 secondes waiting, the update start.



Warning: Do not turn the appliance off while updating

The updating process lasts about 10 minutes.

At the end of the update, the appliance asks you to restart. The software is then loaded into your appliance.
Few Error messages may show up: **Do not take them into account.**

30 Connection of the appliance to a PC

The appliance has an **ETHERNET** interface that make it possible to connect directly to a PC, or via a network.

30.1 Required configuration

These drivers are compatible with the following operating systems: Windows Vista™, Windows XP™, Windows Seven™.

For any other operating system, please contact the technical support SEFRAM.

Your PC should also have a free Ethernet port.

30.2 ETHERNET interface

For this kind of connection, no driver installation is required.

Connect the appliance to the PC with a crossover ETHERNET cable (available in option, ref. 298504246 by SEFRAM).

Configuration of the connection:

Ethernet connection of your appliance to the PC

To change the IP address of your appliance, See chapter “Adjustement”, “IP address” for more details.

The PC software in communication with the appliance must have the same IP address as the appliance :

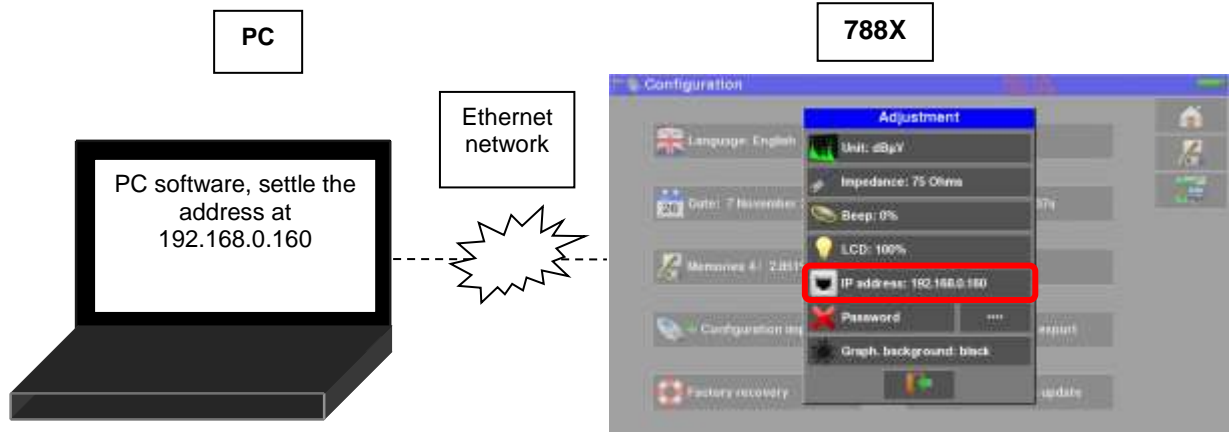

Attention: If the PC has already been connected to Ethernet (network, modem...), it is necessary to reboot the PC before connecting your appliance.

30.3 Network connexion

For the **Ethernet** connection of your appliance to a computer network, see the following scheme:

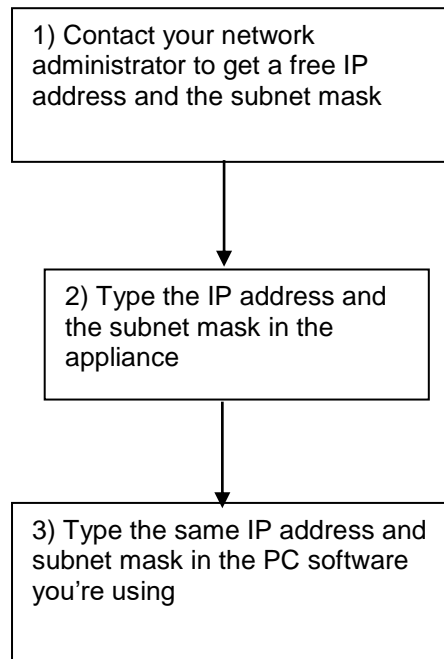

31 HDMI Connection

The appliance includes a HDMI "output" connector;



Attention:

When a HDMI cable is linked to the appliance, the touchscreen is inactive and the screen shuts off.

Plug a mouse to the USB port of the appliance to keep on working on the appliance.

This function allows you to visualize the screen of the appliance on a television (or any screen with a HDMI input); you can still manage the functions of the appliance (with the mouse); you can do measurements, display spectra or TV; the sound of TV is also transmitted to the television through HDMI.

Example of connection:

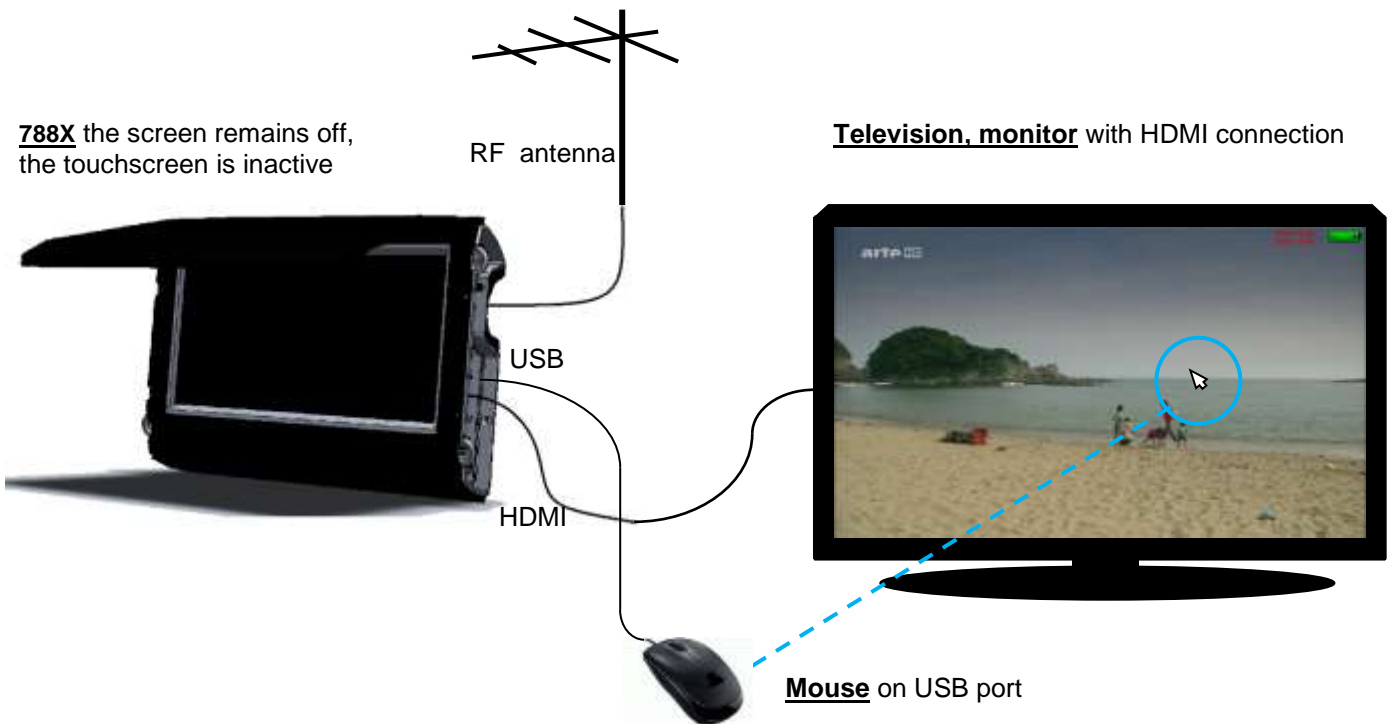

32 Displayed messages

The appliance may display messages while working.

32.1 Alert messages

Low battery: the appliance is about to shut off in a few minutes.



Confirmation request for an important action.

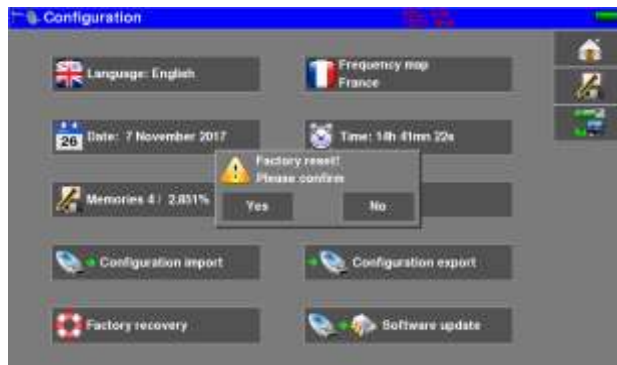

Remote power supply issue: cable under tension or excess intensity above maximum.



Messages of the same kind may show up; the pop up window is an alert; the corresponding message explains the issue.

32.2 Error messages

A message may show up at the bottom of the screen immediately after updating the software.

Do not take it into account as far as it does not show up at a second start-up.

Else, or for any other problem, contact the **SEFRAM** technical support:

➤ **e-mail** : *support@sefram.fr*

➤ **telephone**:



33 Maintenance

This appliance requires some maintenance to meet its requirements and maintain its general characteristics.

	Consequences	Recommended periodicity of controls	Recommended use limit
BATTERY	Reduction of the battery life		200 charge / discharge cycles or 2 years
STRAPS	Breakdown	At each use Check the holding of the straps	
Back Light SCREEN	Reduction of visibility		2 years
Measurement setting / check	Erroneous measures	Once a year	18 months
CONNECTIONS	Erroneous measures	At any measurement	

This "advice" does not engage the responsibility of SEFRAM I.S.

It guarantees the best possible use of the characteristics and the preservation of the product.

Routine maintenance:

The basic maintenance is simply cleaning the outside of the appliance. Any other operation requires a trained personal.

Unplug the appliance before any intervention.

Do not let water flow inside the appliance: risk of electric shock.

Regularly clean the appliance under the following conditions :

- use soapy water
- **never use** any product containing petrol, benzene, alcohols
- wipe out with a soft lint-free cloth
- use a **solvent-free** antistatic product to clean the screen.

RF socket :

- Make sure there are **no copper residues between the core and the mass.**
- Periodically replace the F / F adapter, an adapter in poor condition distorts all measurements.

INFORMATION ABOUT THE LCD COLOR SCREEN WITH ACTIVE MATRIX

Your SEFRAM field strength meter is equipped with a LCD color screen with active matrix.

This screen is provided by renowned manufacturers. In the current technical conditions of manufacture, they cannot guarantee 100% good functioning pixels in the display zone. They specify a number of possible defective pixels at the surface of the screen.

The SEFRAM quality service has preconditioned the mounting of the screen on your instrument to the respect of the acceptance conditions of the manufacturers.

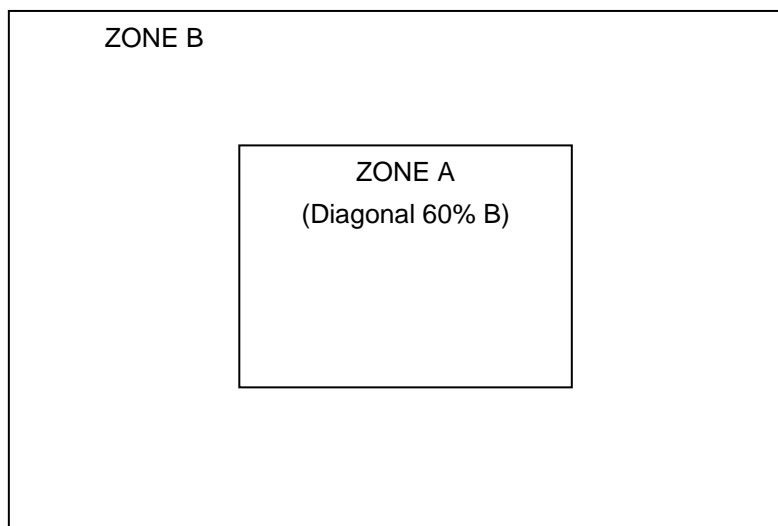

Acceptance criteria:

Zone A (central zone): total less than 5 defective pixels, less than 3 contiguous pixels

Zone B (total surface of the screen): less than 9 defective pixels on the whole surface of the screen, with respect of the conditions prevailing in zone A.

Is considered as defective any pixel on screen that does not light up or lights up in a different color as expected.

The contractual guarantee on your field strength measurer can be exerted only if these criteria are not met, as well at delivery as during the period of guarantee.

34 Technical specifications

34.1 Selection Guide

	7880	7881	7882	7885
Frequencies	5-2200MHz	5-2200MHz	5-2200MHz	5-2200MHz
DVB-T/T2/T2 Lite	✓	✓	✓	✓
DVB-C/C2	✓	✓	✓	✓
DVB-S/S2, DSS, Multistream	✓	✓	✓	✓
J83B MCNS	✓	✓	✓	✓
MPEG2, MPEG4, HEVC, SD/HD	✓	✓	✓	✓
Spectrum Analyser	✓	✓	✓	✓
Triple display: Measures / TV / Spectrum	✓	✓	✓	✓
Display TV, PID, NIT	✓	✓	✓	✓
Display Constellation	✓	✓	✓	✓
Display Echos / pre-Echos	✓	✓	✓	✓
Satellite dish Pointing, simple and double-LNB	✓	✓	✓	✓
Terrestrial Antenna Pointing	✓	✓	✓	✓
SATCR, DCSS	✓	✓	✓	✓
Analog RF TV, PAL, SECAM, NTSC	✓	✓	✓	✓
Ethernet interface	✓	✓	✓	✓
USB	✓	✓	✓	✓
HDMI output	✓	✓	✓	✓
A/V external analog video input	✓	✓	✓	✓
Display MER/porteuse	-	✓	✓	✓
CAM DVB-CI (encrypted TV)	-	✓	✓	✓
ASI input / output	-	-	✓	✓
WIFI (level measurement/SSID)	-	-	✓	✓
IPTV (IAT, TV,...)	-	-	✓	✓
DAB/DAB+, FM-RDS	-	-	-	✓
PVR (MPEG recorder)	-	-	-	✓
GPS (mapping, scan)	-	-	-	✓
Optical Fiber (optical power and demodulation)	-	-	-	✓
TS analyzer TR101290 (alarms, bitrate)	-	-	-	✓

✓ Function fitted

- Function not fitted

34.2 Common technical specifications

Technical specifications	Terrestrial band	Satellite band
Frequencies		
Range	5-1005 MHz	900-2200 MHz
Resolution	measure 50 kHz, display 1 kHz	measure 1MHz, display 1MHz
Level measurements		
Dynamic range	20-120 dB μ V	20-120 dB μ V
Units	dB μ V, dBmV, dBm	
Accuracy	\pm 2dB +/- 0.05dB/ $^{\circ}$ C	
Resolution	0,1dB	
Measurement Filters	25kHz	125kHz
Standards	DVB-C/C2, DVB-T/T2/T2lite, J83B MCNS BG, DK, I, L, MN, carrier FM-RDS, DAB/DAB+	DVB-S/S2, DSS PAL, SECAM, NTSC, carrier
Measurements	RF level/power, C/N, V/A	
Spectrum Analyser		
Span	1MHz to full span in 1,2,5 step	
Sweep speed	100 ms mini, 500 ms maxi	
Filters (auto according to span)	1.25kHz, 2.5kHz, 6.25kHz, 12.5kHz, 25kHz, 62.5kHz, 125kHz, 250kHz, 625kHz, 1.25MHz, 2.5MHz	
Attenuator	automatic or manual (0 to 55 dB with 5 dB step)	
Dynamic range (display)	60 dB (10 dB/div)	
NIT and OSD TV	yes	
Pre-echoes /Echoes DVBT/T2		
Dynamic range	DVB-T : 30 dB, 75km (8k) DVB-T2 : 50 dB, -75km +75km (8k) DVB-C2 : 50 dB, -35km +35km (4k)	
Units	μ s, km, miles	
Constellation display		
	yes, standards DVB-T/T2/T2 Lite, DVB-C/C2, J83B, DVB-S/S2, DSS	
Measurement Map		
Capacity	scanning of 50 setups maximum	
Display	graphic (bargraph), tilt measurement	
TV picture and sound		
Analog TV	PAL, SECAM, NTSC, terrestrial only	
Digital TV Multiplex (*)	MPEG2, MPEG4, HEVC, SD and HD definition	
Sounds	MPEG-1, MPEG-2, AAC, HE AAC, Dolby® Digital, Dolby® Digital Plus	
Encrypted Services	Uncrypt using CAM and smart card	
Service table DVB-SI	SDT, NIT, PID audio/video, LCN	
PVR	recording current Service + tables DVB-SI on USB stick	
MPEG TS analysis	ETR101290 alarms, bit rates	
FM-RDS		
Frequencies	88-108MHz	
Services RDS	PS, PI, PTY, ECC, RT	

34.3 Digital measurements

DVB-T/H	
Bit Error Rate (BER)	CBER (before Viterbi BERi) VBER (after Viterbi BERo) UNC (lost packets PER) Noise margin
Modulation Error Rate(MER)	15 - 35dB
Sensitivity	< 35dBμV
Bandwidth	6MHz, 7 MHz, 8 MHz
FFT type	2k, 8k, auto
Constellation	QPSK, 16QAM, 64QAM, auto
Viterbi rate	1/2, 2/3, 3/4, 5/6, 7/8, auto
Guard interval	auto, manual
Spectrum inversion	auto
HP/LP – PLP – Data Slice	HP/LP
Standards	ETS 300-744

DVB-T2 / T2 Lite	
Bit Error Rate (BER)	LDPC (BERi) BCH (BERo) FER (frame error PER) Noise margin
Modulation Error Rate(MER)	15 - 35dB
Sensitivity	< 35dBμV
Bandwidth	1.7MHz, 5MHz, 6MHz, 7 MHz, 8 MHz
Mode	SISO, MISO, PLP single or multiple
FFT type	1k, 2k, 4k, 8k, 16k, 32k + extended bandwidth, auto
Constellation	QPSK, 16QAM, 64QAM, 256QAM, auto
Viterbi rate	1/2, 3/5, 2/3, 3/4, 4/5, 5/6, 1/3, 2/5, auto
Guard Interval	auto
Spectrum inversion	auto
HP/LP – PLP – Data Slice	PLP
Standards	ETS 302-755

DAB/DAB+	
Taux d'erreur (BER)	BER (BERo)
Bandwidth	1.7MHz
Frequencies	Band 3, 174.928 - 239.2MHz (channels 5A - 13F)
Sensitivity	< 35dBμV
Mode	Mode 1, COFDM FFT 2k
Sound	DAB : MPEG2 Audio Layer II DAB+ : HE-AAC+ v2
Standards	ETS 300-401

DVB-C J83A	
Bit Error Rate (BER)	BER (before Reed Solomon BERo) UNC (lost packets PER) Noise margin
Modulation Error Rate(MER)	20 - 40dB
Sensitivity	< 55dBμV
Symbol Rate	1 to 7.224 Ms/s
Constellation	16QAM, 32QAM, 64QAM, 128QAM, 256QAM
Spectrum inversion	auto
Standards	ETS 300-429

DVB-C2	
Bit Error Rate (BER)	LDPC (BERi) BCH (BERo) FER (frame error PER) Noise margin
Modulation Error Rate(MER)	25 - 35dB
Sensitivity	< 55dB μ V
Symbol rate	-
Bandwidth	6MHz, 8 MHz
Mode	PLP and data slice, single or multiple
FFT type	4k
Constellation	16QAM, 64QAM, 256QAM, 1024QAM, 4096QAM, auto
Viterbi rate	2/3, 3/4, 4/5, 5/6, 8/9, 9/10
Guard interval	auto
Spectrum inversion	auto
HP/LP – PLP – Data Slice	PLP+Data Slice
Standards	ETS 302-769

MCNS J83B	
Bit Error Rate (BER)	BER (before Reed Solomon BERo) UNC (lost packets PER) Noise margin
Modulation Error Rate (MER)	20 - 35dB
Sensitivity	< 55dB μ V
Symbol rate	1 à 5.563 Ms/s
Constellation	64QAM, 256QAM
Spectrum inversion	auto
Standards	ETS 302-769

DVB-S, DSS	
Bit Error Rate (BER)	CBER (before Viterbi BERi) VBER (after Viterbi BERo) UNC (lost packets PER) Link margin
Modulation Error Rate (MER)	0 - 20dB
Sensitivity	< 47dB μ V
Symbole rate	1 to 45Ms/s
Constellation	QPSK
Viterbi rate	1/2, 2/3, 3/4, 5/6, 6/7, 7/8, auto
Spectrum inversion	auto
Standards	ETS 300-421

DVB-S2	
Bit Error Rate (BER)	LDPC (BERi) BCH (BERo) PER Link margin
Modulation Error Rate(MER)	0 - 20dB
Sensitivity	< 47dB μ V
Symbol rate	1 to 45Ms/s
Constellation	QPSK, 8PSK, 16APSK, 32APSK
Modulation	CCM, VCM, ACM
Multistream	stream select ISI 0-99, PL scrambling (Gold code)
Viterbi rate	2/5, 1/2, 3/5, 2/3, 3/4, 5/6, 8/9, 9/10, auto
Spectrum inversion	auto
Standards	ETS 302-307

34.4 Divers

Remote supply	Terrestrial	Satellite
Voltage	5V/13V/18 V/24V 500 mA max (300mA for 24V)	13/18 V 500 mA max
DiSEqC	-	DiSEqC 1.2 control of dish motor switches committed & uncommitted
Mini DiSEqC (22kHz)	-	22 kHz, ToneBurst
SCD /SATCR EN 50494 Single cable satellite distribution	-	8 slots max switch committed
SCD2 EN 50607 Single cable satellite distribution v2	-	32 slots max switchs committed & uncommitted code PIN

Storage	
Memory	Internal on non-volatile memory, or external USB stick (not supplied)
Data saved	measurements (level, BER/MER, Measurement Maps, Spectrum,...)
Capacity	512 Ko (1000 files max or folders)

Inputs / Outputs	
RF input	75 Ohms, F adaptor supplied, TOS > 10dB
Max permitted voltage	50V rms. / 50Hz
Interfaces	USB A, Ethernet 10baseT (RJ45)
DC supply input	jack 5.5 mm 15 V max, 5 A max
ASI input / output (option)	BNC 75 ohms frequency 270 MHz 188/204 bits maximum usable bitrate 70 Mbit/s
A/V analog video input	JACK 3.5mm, 4 contacts
HDMI output (option)	resolution 720p 1280x720 progressive framerate 50Hz
WiFi	2.4GHz / 5GHz antenna input SMA 50 ohms reverse measurement of levels per SSID
GPS	antenna input SMA 50 ohms remote supply 3VDC or 5VDC, 100mA max cartography, GPS reception survey
Optical Fiber input	FC/APC monomode 1310-1490-1550nm optical power measurement : dynamic -50 / +10 dBm accuracy 0.5dB simultaneous measurement triple wavelength optical to RF conversion : dynamic -12 / -3 dBm single wavelength
5,45GHz RF input	SMA 50 ohms remote supply 6.2V DC, 500mA max

34.5 General specifications

Display	LCD TFT 10 inch color, 16/9, backlight 500 cd/m ² , 1280x800 dots touch screen, capacitive technology,
External supply	Main adaptor 110/230 VAC, with 5,5mm jack, 15 V 4.6 A
Battery	Li-ion 100W
Autonomy	4 hours typical, depending of use
Charging time	1,5 hour for 80% of capacity
Operating temperature	-5°C to 45°C
Storage temperature	-10°C to 60°C
Dimensions	310 x 210 x 80 mm
Weight	2,8 kg (including battery and protective pouch)

Supplied with:

main adaptor, user's manual (CD-ROM), F/F adaptor, belt, clip, transportation bag.

34.6 Accessories

Optional accessories:

- Car cigar lighter adaptor P/N 978361000
- F/F adaptor P/N 213200012
- F/BNC adaptor P/N 213200011
- BNC/TV female adaptor P/N 213200010
- ETHERNET cable (crossed) P/N 298504246
- Carrying bag P/N 978851000
- valide de transport P/N 978852000
- A/V external video cable P/N 978853000
- Optical fiber patchcord FC-PC / PC-APC P/N 978754700
- Optical fiber patchcord FC-APC / SC-APC P/N 978754710

To check for price and availability, please contact our sales department.

34.7 V, dBμV, dBmV et dBm conversion

dBμV (dBmV) is a logarithmic ratio between a measured voltage U_d and a reference voltage U_r .

The reference voltage is $U_r = 1 \mu\text{V}$ (1 mV)

$$N = 20 \log (U_d/U_r)$$

dBm is a logarithmic ratio between a measured power P_d and a reference power P_r .

The reference power is $P_r = 1 \text{ mW}$ into 75 ohms.

$$N = 10 \log (P_d/P_r) \text{ with } P_d = U_d^2 / 75$$

$U_d = 1 \mu\text{V}$	$N = 0 \text{ dB}\mu\text{V}$	$N = -60 \text{ dBmV}$	$N = -108.75 \text{ dBm}$
$U_d = 1 \text{ mV}$	$N = 60 \text{ dB}\mu\text{V}$	$N = 0 \text{ dBmV}$	$N = -48.75 \text{ dBm}$
$U_d = 1 \text{ V}$	$N = 120 \text{ dB}\mu\text{V}$	$N = 60 \text{ dBmV}$	$N = 11.25 \text{ dBm}$

34.8 Typical values for measurements

Values given are indicatives, minimum and maximum for good signal quality

Measurements	Level, power (dBμV)		C/N (dB)	BER	MER (dB)	modulation
	mini	maxi				
Terrestrial						
Analog TV	57	74	> 45	-	-	-
FM	50	66	> 38	-	-	-
DAB/DAB+	35	70		BER < 2 ^{E-4}	-	2K
DVB-T/H	35	70	> 26	VBER < 2 ^{E-4}	> 26	8K, 64QAM, 1/32, 2/3
DVB-T2	35	70	> 22	FER < 2 ^{E-7}	> 22	32K, 256QAM, 1/8, 2/3
DVB-C	57	74	> 31	BER < 2 ^{E-4}	> 31	64QAM
J83B	57	74	> 31	BER < 2 ^{E-4}	> 31	64QAM
Satellite						
Analog TV	47	77	> 15	-	-	-
DVB-S, DSS	47	77	> 11	VBER < 2 ^{E-4}	> 11	QPSK, 3/4
DVB-S2	47	77	> 8	PER < 1 ^{E-7}	> 8	8PSK, 2/3

35 CE Declaration

EU DECLARATION OF CONFORMITY

According to EC directives
DECLARATION DE CONFORMITE UE
Suivant directives CE

SEFRAM INSTRUMENTS SAS
32, rue Edouard MARTEL
42009 SAINT-ETIENNE Cedex 2 (FRANCE)

Declares, that the below mentioned product complies with:
Déclare que le produit désigné ci-après est conforme à :

The European low voltage directive 2014/35/EU:

La directive Européenne basse tension 2014/35/UE

NF EN 61010-1 Safety requirements for electrical equipment for measurement, control and laboratory use.

Règles de sécurité pour les appareils électriques de mesurage, de régulation et de laboratoire.

The European EMC directive 2014/30/EU:

Emission standard EN 61326-1, EN 61326-2-1.

Immunity standard EN 61326-1, EN 61326-2-1.

La directive Européenne CEM 2014/30/EU :

En émission selon NF EN 61326-1, EN 61326-2-1.

En immunité selon NF EN 61326-1, EN 61326-2-1.

The European of radio equipment directive 2014/53/EU:

ETSI 300328 Electromagnetic compatibility and Radio spectrum Matters

La directive Européenne RED 2014/53/EU:

ETSI 300328 Compatibilité électromagnétique et spectre radioélectrique

The European directives 2011/65/EU on the restriction of the use of certain hazardous substances in electrical and electronic equipment

La directive Européenne 2011/65/EU relative à la limitation de l'utilisation de certaines substances dangereuses dans les équipements électriques et électroniques:

Pollution degree *Degré de pollution : 2*

Product name *Désignation :* **Field Strength Meter** *Mesureur de champ*

Model Type: **7880 – 7881 – 7882 - 7885**

Compliance was demonstrated in listed laboratory and record in test report number

La conformité à été démontrée dans un laboratoire reconnu et enregistrée dans le rapport numéro **RC 7880**

SAINT-ETIENNE the:
Thursday, 14 December 2017

Name/Position:
CLERJON / Quality Manager

P.O.



SEFRAM
32, rue Edouard MARTEL
BP 55
F42009 SAINT-ETIENNE Cedex
France

Phone : +33 (0)4 77 59 01 01

Fax : +33 (0)4 77 57 23 23

Sales department e-mail : sales@sefram.fr

Technical support e-mail : support@sefram.fr

Website : www.sefram.fr