

Power Source & Sink

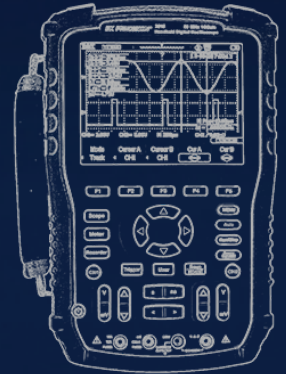

Signal Generation & Analysis



Component Testing



Product Catalog

About B&K Precision



"We are committed to continuing our work of developing new, exciting and dependable equipment to serve your testing needs."

A Message from the President

It's hard to imagine that B&K Precision has been serving the electronics industry for 65 years now. From modest beginnings in a TV repair shop in Chicago, to today's modern manufacturing facilities in Taiwan, France, and China; R&D and marketing offices in the US, Israel, and Romania; and distributors in over 50 countries, B&K has continued to innovate, strengthen, and expand its product offerings.

Today's electronic engineers and students may not recall the era of cathode ray tubes, but our company started by making products to test, repair, and even rejuvenate CRT's, extending the life-span of TV sets. With broad changes in technology over the past six decades, we've continued to develop diverse test and measurement solutions, including our DC & AC power supplies, DC electronic loads, LCR meters, oscilloscopes and signal generators.

Many technical schools and universities around the world use our instruments, particularly our function and arbitrary waveform generators, multimeters and oscilloscopes, to teach students about fundamental and advanced electronics. Our commitment to education has led us to the creation of a program that rewards enterprising schools and students with free test equipment.

As we look forward to the future with our global team of dedicated employees, we are committed to continuing our work of developing new, exciting and dependable test equipment to serve your ever changing testing needs.

Sincerely
Victor Tolan
President and CEO

Introduction

For more than 60 years B&K Precision has provided test and measurement solutions to customers from wide-ranging fields including research and development, product design, industrial maintenance, electronic field service, production line testing, and the educational community, among others. Universities and technical schools worldwide have made our instruments standard equipment in their training programs.

Since 1951, the B&K Precision name has represented quality, consistency, and value. We take pride in supplying outstanding products and excellent service at fair prices. Full certification by the International Organization for Standardization (ISO 9001:2008) reflects our commitment to quality. Our mission is to maintain the standards that have built our reputation, develop new products to meet advancing needs, and continue providing the products and service our customers have come to trust.

B&K offers a wide range of power test and general purpose instruments. Our core products include power supplies and DC electronic loads, battery testers, signal generators (especially function and arbitrary generators), component testers, oscilloscopes, spectrum analyzers, and multimeters. We provide a full complement of device programmers, video and cable testers, electrical and battery testers, and environmental testers. We also supply a comprehensive array of probes, leads, adapters, and additional accessories that make testing easier.

We stand behind every product we ship. Our warranties are valid worldwide, and we provide global service and support to guarantee your satisfaction. A growing number of our instruments come with a standard 3-year warranty, covering parts and labor.

Our in-house technicians work directly with you to provide any necessary calibrations or repairs, ensuring optimum performance.

History

B&K Precision helped pioneer the electronic testing industry, and like so many early electronics firms, B&K started in a garage. By 1948, when Americans had begun buying televisions in large numbers, Chicago entrepreneur Carl Korn and his partner Philip Ban responded to the need for maintenance of often-unreliable sets. Frustrated by a lack of equipment to easily test television components, Ban and Korn began making their own testing devices and opened Central Television Service Company. They soon had a thriving business selling CRT rejuvenators and vacuum tube testers to other television service shops. By 1951, Korn had developed what would become B&K Precision into a company that had branched out into other areas of electronic testing and measurement. B&K engineers broke new ground, earning several patents in the field of television test equipment, and rapidly pushed the company to become a worldwide leader in electronic measurement.



Global network of partner companies

● B&K Precision group member ● Independent service center ○ Service center location

In 1961, Carl Korn placed B&K Precision under an umbrella corporation, Dynascan, comprising a variety of electronics firms. One of those companies, Cobra Electronics, came to dominate the Citizen's Band (CB) radio phenomenon. Choosing to focus on radios, Korn sold B&K Precision. Through an ensuing series of ownership transitions B&K continued to produce high-quality test and measurement products.

In 1996, engineer Victor Tolan, headed up a new ownership team for B&K Precision that launched a greatly expanded product line. The company also expanded upon its American base to better serve international customers. Company headquarters moved to southern California to provide improved service to Asia. In 2004, B&K expanded its presence in Europe through the acquisition of Sefram Instruments to better meet customer needs in the region. With the acquisition of Motech Industries' instrument division in 2011, we strengthened our expertise in programmable linear and high power switching power supplies.

B&K Precision has come a long way from its days in Carl Korn's garage, but holds fast to the business ideals of innovation, flexibility, and solid customer service that has guided the company from its humble beginnings in America, while reaching out to embrace the rapidly expanding global marketplace. We now provide service and support on four continents, and our design team draws upon resources in places as wide-ranging as Romania, Israel, and Taiwan.



Americas – B&K Precision

Our headquarters in Yorba Linda, California house most of our administrative and executive functions including research and design, customer service and repair, and sales and marketing. The California warehouse ships to North, Central, and South America, and our service center provides our customers with live, one-on-one support. Our B&K Brasil office supports our expanding customer base in Brazil and other South American countries.

Europe – Sefram

Our European customers have become most familiar with B&K through our Sefram subsidiary. Sefram's offices in St. Etienne, France currently support customers in Europe, the Middle East, and Africa.

Asia – B+K Taiwan, BK China and Itech

Our B+K Taiwan and Itech plants primarily design and manufacture programmable power supplies and DC loads, and together with the BK China office provide distribution,

sales and service support for that region. Engineers in China also know us through our Itech brand. The independent service center in Singapore services customers in Singapore, Malaysia, Vietnam, and Indonesia.

Our distribution partners

An extensive network of independent distributors offers B&K Precision products around the globe. Visit our website to find your local authorized distributor, and even view available inventory from participating distributors. You can buy in confidence, knowing that all our products carry B&K's warranty, and worldwide service and support.

As B&K Precision keeps growing, we continue to uphold the standards we set more than a half-century ago even as we find new answers to our customers' needs. Whether you require measuring devices for a new venture; test equipment to ensure standards adherence; technology for teaching budding young scientists—or instruments for test and measurement challenges that depend on quality and accuracy, B&K Precision Corporation has solutions.

Video Library

View product overviews, demonstrations, and application videos in English, Spanish and Portuguese.

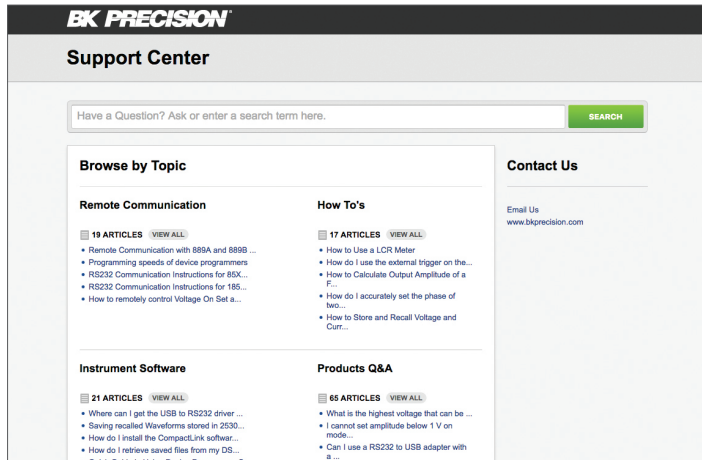

Knowledge Base

Search and find answers to frequently asked questions, plus a wealth of resources: how-to guides, technical notes and other articles.

Product Applications

Browse all of our supported product and mobile applications.



CONTENTS

4 Power Supplies

- 6 ATE System & Application-Specific
- 11 General Purpose, Programmable
- 17 Basic & Education, Non-Programmable
- 19 AC Sources / Power Meters

22 DC Electronic Loads

- 24 Modular
- 26 Stand-Alone Programmable
- 29 Basic

30 Oscilloscopes

- 32 DSO/MSO
- 35 DSO
- 36 Handheld
- 37 Economy and Analog

38 Component Testers

- 40 Bench LCR
- 42 Handheld LCR
- 43 Handheld Capacitance, IC, ESR, Logic
- 44 DC Resistance

45 Battery Testers

- 45 Overview, Battery Analyzers
- 47 Frequency Response Analyzer

48 Signal Generators

- 51 True Arbitrary & Function Arbitrary
- 54 Digital (DDS)
- 55 Pulse
- 56 Analog

57 Spectrum Analyzers

60 Multimeters

65 Electrical Testers

66 Device Programmers & Counters

67 Video & Cable / Environmental Testers

69 Accessories (probes, leads, adapters)

72 Index



POWER SUPPLIES

Clean and reliable power



Category / Subcategory	Page
ATE System & Application-Specific Power Supplies	
ATE and LED	6 - 7
ATE and Solar	8 - 9
ATE and Automotive	10
General Purpose Programmable Power Supplies	
Single Output	14 -16
Triple Output	11
Dual and Multi-Range	12 -13
Basic & Education Non-Programmable Power Supplies	
Single Output	17
Triple Output	18
Multi-Range	18
Battery Eliminators and CV Power Supplies	18
AC Sources & Power Meters	
Programmable AC Sources	19
Power Meters	20
Non-Programmable AC Sources	21

Finding the right power supply

B&K Precision's power supply families cover basic to high performance, 30 W to 5100 W, single or multiple outputs, programmable and non-programmable, linear, switching, mixed mode, multi range (auto), dual range, as well as support for all industry standard computer interfaces such as USB, GPIB, and LAN.

Power supply guide

Introduction to different power supply types and the technology behind them, plus related terms, specifications and usage examples.

Visit "Applications" page at bkprecision.com

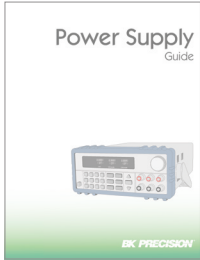

Power Supplies

ATE System Power & LED



Model 9174B



* optional

9170B/9180B Series Programmable Dual-Range DC Power Supplies

The 9170B/9180B Series programmable DC power supplies offer industry leading performance, designed to meet the most demanding applications in R&D, design verification and production test. All 9 models deliver clean, stable and precise output power due to the supplies' exceptionally low ripple and noise, low temperature coefficient, excellent regulation and fast transient response time characteristics. Additionally, the 9170B/9180B Series offers unique features not typically found in other power sources on the market, such as versatile LED test modes, modular interface card slots, automatic range selection, and an optional 8-bit bidirectional digital I/O interface.

LED mode

With LED mode active, inrush current will be eliminated or minimized to protect the UUT.

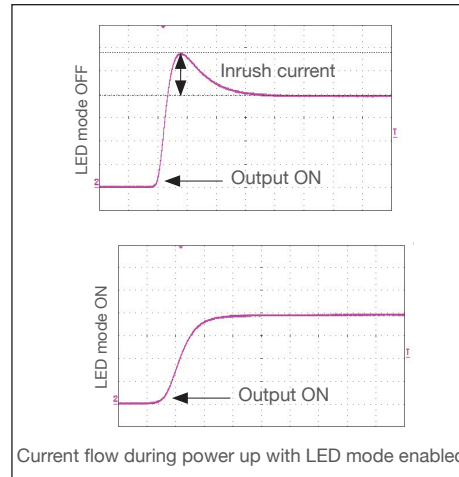

Features & Benefits

- Single and dual output models with up to 210 W output power
- Exceptionally low ripple and noise (e.g. 0.35 mVrms/3 mVpp for model 9171B)
- Fast transient response time of < 50 us most models
- Fast command processing time, less than 10 ms
- Dual range output with automatic range selection*
- Programmable voltage and current slew rates
- Front and rear panel output
- Remote sense terminals
- List mode for executing up to 10 stored test sequences with a maximum of 150 steps in total
- Store and recall up to 10 power settings
- Overvoltage/overcurrent/overtemperature protection (OVP/OCP/OTP) and key-lock function
- Application software providing remote control capability included

*All models except for high voltage models 9184B and 9185B

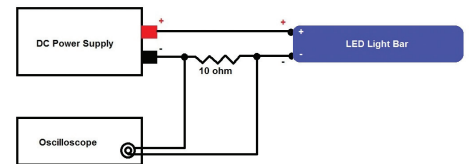

Example LED test setup

Output rating		No. of outputs	Load regulation		Ripple and noise* normal mode		Programming/readback resolution		Model
Low Range	High Range		Voltage	Current	Voltage	Current	Voltage	Current	
0-10 V, 0-10 A	0-20 V, 0-5 A	1	≤ 0.01 %+1 mV	≤ 0.01 %+250 uA	≤ 0.35 mVrms/≤ 3 mVpp	≤ 2 mA rms	< 1 mV	< 1 mA	9171B
0-35 V, 0-3 A	0-70 V, 0-1.5 A	1	≤ 0.01 %+1 mV	≤ 0.01 %+250 uA	≤ 0.5 mVrms/≤ 5 mVpp	≤ 2 mA rms	< 2 mV	< 0.1 mA	9172B
0-10 V, 0-10 A	0-20 V, 0-5 A	2	≤ 0.01 %+1 mV	≤ 0.01 %+250 uA	≤ 0.35 mVrms/≤ 3 mVpp	≤ 2 mA rms	< 1 mV	< 1 mA	9173B
0-35 V, 0-3 A	0-70 V, 0-1.5 A	2	≤ 0.01 %+1 mV	≤ 0.01 %+250 uA	≤ 0.5 mVrms/≤ 5 mVpp	≤ 2 mA rms	< 2 mV	< 0.1 mA	9174B
0-18 V, 0-8 A	0-36 V, 0-4 A	1	≤ 0.01 %+1 mV	≤ 0.01 %+250 uA	≤ 0.35 mVrms/≤ 3 mVpp	≤ 2 mA rms	< 1 mV	< 1 mA	9181B
0-10 V, 0-20 A	0-20 V, 0-10 A	1	≤ 0.01 %+1 mV	≤ 0.01 %+250 uA	≤ 0.35 mVrms/≤ 3 mVpp	≤ 2 mA rms	< 1 mV	< 1 mA	9182B
0-35 V, 0-6 A	0-70 V, 0-3 A	1	≤ 0.01 %+1 mV	≤ 0.01 %+250 uA	≤ 0.5 mVrms/≤ 5 mVpp	≤ 2 mA rms	< 2 mV	< 0.2 mA	9183B
0-100 V, 0-2 A	0-200 V, 0-1 A	1	≤ 0.01 %+1 mV	≤ 0.01 %+250 uA	≤ 1.5 mVrms/≤ 15 mVpp	≤ 2 mA rms	< 10 mV	< 0.1 mA	9184B
0-400 V, 0-0.5 A	0-600 V, 0-0.35 A	1	≤ 0.01 %+1 mV	≤ 0.01 %+250 uA	≤ 4.5 mVrms/≤ 45 mVpp	≤ 2 mA rms	< 10 mV	< 0.01 mA	9185B

*Ripple and noise (20 Hz - 20 MHz)



XLN Series Family of High Density System Power Supplies

The B&K Precision XLN Series are compact, programmable, single-output DC power supplies, suitable for a wide range of applications. Comparable supplies from other manufacturers primarily address the ATE market only, while the XLN Series are designed for both benchtop users and system integrators.

For benchtop applications, these power supplies offer built-in voltage and current meters displaying setting and output values concurrently, as well as an intuitive user interface with full keypad and rotary knob.

Standard USB & RS485 and optional GPIB & LAN interfaces combined with fast average

Features	High current XLN models	High voltage XLN models
Auxiliary output	5 V / 1 A	-
Master/Slave operation	Parallel/ Series	Parallel Only
Display resolution	1 mV/1 mA	10 mV/1 mA
Analog programming	✓	✓
Analog monitoring	-	✓

command processing times of less than 50 ms make the XLN Series ideal for ATE applications. The XLN Series support SCPI IEEE488.2 and come with LabVIEW™ drivers and application software.

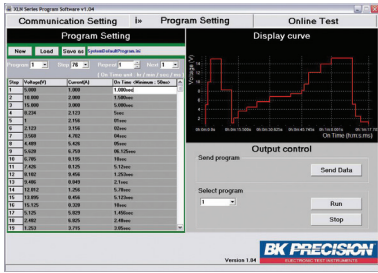

Generate, save, and load program lists. View output characteristic curves and export data to a file.

The GPIB/LAN interface also provides a built-in web server. This allows users to configure, control, or monitor the basic settings of the power supply from a remote computer using a web browser.

Voltage and current values can also be programmed through the analog interface by applying a voltage or current source. High voltage models also provide additional monitoring functions such as output voltage/ current monitoring and indicators for regulation mode (CC or CV) and fault alarms.



* optional

Features & Benefits

- Compact, high density, 1U package
- USB interface (standard) and GPIB/LAN (optional)
- External analog programming interface
- List mode for executing up to 150 step test sequences from instrument memory
- Fast command processing time < 50 ms
- Programmable voltage and current slew rate allow for "soft starting" of loads
- Easy to configure master/slave mode for series or parallel connection up to 4 units
- Extensive protection features: OVP, OCP, OPP, and key-lock function
- 100 - 240 V universal AC input with power factor corrections
- Control up 31 power supplies from one PC via RS485 interface

pwrApp for iPad, iPhone & iPod touch

Specifications	High current				High voltage			
	XLN3640	XLN6024	XLN8018	XLN10014	XLN15010	XLN30052	XLN60026	
GPIB & LAN version	XLN3640-GL	XLN6024-GL	XLN8018-GL	XLN10014-GL	XLN15010-GL	XLN30052-GL	XLN60026-GL	
Output voltage	0-36 V	0-60 V	0-80 V	0-100 V	5 -150 V	5 - 300 V	5 - 600 V	
Output current	0-40 A	0-24 A	0-18 A	0-14.4 A	0.04 - 10.4 A	0.02 - 5.2 A	0.01 - 2.6 A	
Load regulation	Voltage	≤ 8 mV	≤ 8 mV	≤ 10 mV	≤ 12 mV	≤ 17 mV	≤ 32 mV	≤ 62 mV
	Current	≤ 8 mA	≤ 7 mA	≤ 6.5 mA	≤ 6 mA	≤ 0.1% + 30 mA	≤ 0.1% + 15.6 mA	≤ 0.1% + 7.8 mA
Programming accuracy	Voltage	0.05% + 10 mV	0.05% + 15 mV	0.05% + 20 mV	0.05% + 25 mV	0.05% + 75 mV	0.05% + 150 mV	0.05% + 300 mV
	Current	0.05% + 10 mA	0.05% + 18 mA	0.05% + 7 mA	0.05% + 6 mA	0.1% + 30 mA	0.1% + 15.6 mA	0.1% + 7.8 mA
Ripple and noise	Voltage	≤ 5 mVrms/ ≤ 60 mVpp	≤ 6 mVrms/ ≤ 70 mVpp	≤ 7 mVrms/ ≤ 80 mVpp	≤ 8 mVrms/ ≤ 80 mVpp	≤ 10 mVrms/ ≤ 100 mVpp	≤ 25 mVrms/ ≤ 150 mVpp	≤ 50 mVrms/ ≤ 300 mVpp
	Current	≤ 90 mA	≤ 70 mA	≤ 50 mA	≤ 40 mA	≤ 15 mA	≤ 10 mA	≤ 5 mA

Power Supplies

ATE System Power & Solar



PVS Series High Power Programmable DC Power Supplies

The PVS Series delivers programmable output power up to 5.1 kW and is well suited for bench use, ATE systems integration, R&D, design verification, production test, and high voltage testing. The low-noise characteristic of the PVS Series makes these instruments particularly ideal for motor inverter testing. When operated with the optional SAS software, these power supplies can be used for solar array testing applications.

Model		PVS60085	PVS60085MR	PVS10005
Output ratings	Voltage	600 V		1000 V
	Current	8.5 A		5 A
	Power	5100 W	3000 W	5000 W
Load regulation	Voltage	60 mV		100 mV
	Current	8.5 mA		5 mA
Ripple & noise (20 Hz to 20 MHz)	Voltage	≤ 100 mVrms / ≤ 500 mVpp		≤ 100 mVrms / ≤ 600 mVpp
	Current	15 mA		10 mA
Programming accuracy	Voltage	400 mV		700 mV
	Current	0.03% + 3.5 mA		0.03% + 2 mA
Dimensions (W x H x D)		420 mm x 88 mm x 532 mm		
Weight		14.6 kg		

Model PVS60085MR is a multi-ranging supply allowing any combination of the rated voltage and current up to the maximum output power of 3000 W.

Application software

PC software is provided for front panel emulation, generating and executing test sequences or logging measurement data without the need to write source code.

- Save and load list files to/from the power supply's internal memory.
- Create an unlimited number of external list files to be executed from PC memory. Save and recall list files to/from the PC.
- Log voltage, current, and power values as well as time stamp, CV/CC, and output status.
- Remote monitoring on iOS, Android, or Windows 8 compatible tablets or smart phones via NI Data Dashboard for LabVIEW apps. Quickly develop a custom dashboard consisting of one (smart phone) or several (tablet) indicators, charts, or gauges to monitor your power supply.



Features & Benefits

- Compact, high power density, 2U package
- Convenient single-phase AC input configuration
- Fast transient response time of ≤ 0.5 ms
- Standard USB (virtual COM), RS232, GPIB and LAN interfaces supporting SCPI commands
- External analog programming and monitoring interface
- Extensive protection features: OVP, OCP, OPP, OTP, foldback protection mode, and key-lock function

Web server interface

The PVS Series models provide a built-in web server that allows users to configure, control, or monitor the basic settings of the power supply from a remote computer using a web browser.

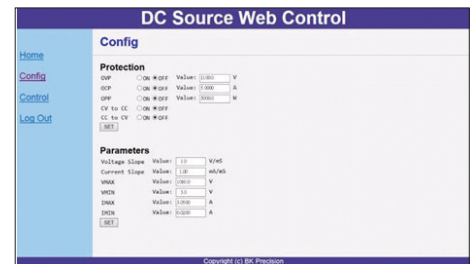

Solar Array Simulation (SAS) Software Option

Solar inverter designers need to verify their inverter is capable of delivering the maximum power available from solar modules. The I-V curve of solar cells can be influenced by various weather conditions such as a cloudy day. Combined with the SAS PV application software, PVS users can easily simulate the I-V curve of different arrays under various irradiance conditions while measuring and validating the effectiveness of the inverter's MPPT algorithm. The PVS power supply outputs points on the I-V curve in 1 ms intervals to test the inverter's MPPT efficiency.

Features

- Test to EN50530, Sandia, and NB/T32004 standards
- Monitors and logs real-time voltage, current, power, MPPT efficiency, and average MPPT efficiency
- Simulate I-V curve under different weather conditions during a day
- User-definable irradiance profile
- Generate a custom I-V curve with up to 4,096 data points
- Shadow I-V curve simulation
- Comprehensive built-in list of defined I-V curves of PV modules from various manufacturers for simulation

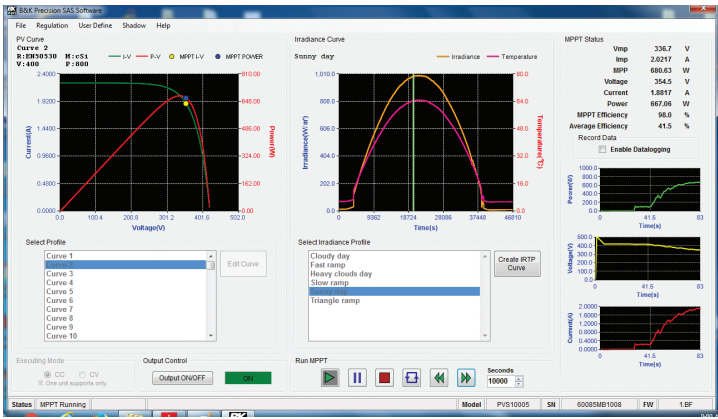

I-V curve generation to regulation standards

The 'Curve Config' dialog box allows users to define I-V curves based on regulation standards and material types. It includes fields for Regulation (EN50530), Vmp (250.00), Material (cSi), and Pmp (250.00). A table below lists 10 curves with their respective parameters.

Curve #	Regulation	Vmp	Pmp	Material
1	EN50530	250.00	250.00	cSi
2	EN50530	350.00	350.00	cSi
3	EN50530	250.00	250.00	cSi
4	EN50530	250.00	250.00	cSi
5	EN50530	250.00	250.00	cSi
6	EN50530	250.00	250.00	cSi
7	EN50530	250.00	250.00	cSi
8	EN50530	250.00	250.00	cSi
9	EN50530	250.00	250.00	cSi
10	EN50530	250.00	250.00	cSi

Automatically generate the I-V curve of solar array in the software by specifying the regulation standard, material type of the solar array, maximum voltage point (Vmp), and maximum power point (Pmp).

Shadow I-V curve simulation

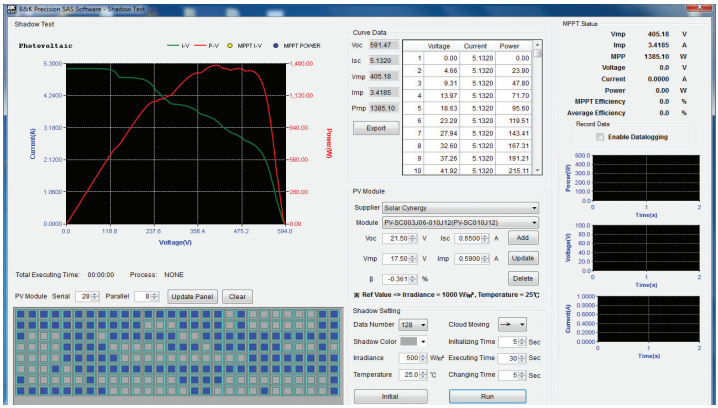

Create shadow I-V curves by specifying shadowed cells of PV module and setting cloud direction, change time, and other parameters to simulate shadow and cloudy dynamic conditions.

User-defined I-V curve

	A	B	C
1	1000	0	
2	999.873	0.0049	
3	999.746	0.0098	
4	999.619	0.0147	
5	999.492	0.0196	
6	999.365	0.0244	
7	999.238	0.0293	
8	999.11	0.0342	
9	998.983	0.0391	
10	998.856	0.044	
11	998.729	0.0489	
12	998.602	0.0538	
13	998.475	0.0587	

Generate an I-V curve manually via a 4,096-point voltage and current table with Notepad or MS Excel and load it in the software.

Built-in irradiance profiles

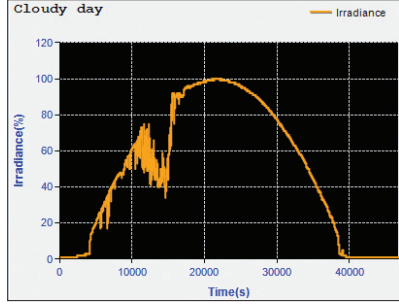

Use any of the software's built-in irradiance profiles or generate your own point-by-point irradiance profile.

Power Supplies

ATE System Power & Automotive



* 9117 only

9115 Series 1200 W Multi-Range DC Power Supplies

Any 9115 Series model can replace several supplies on your bench or in your rack. Unlike conventional supplies with fixed output ratings, these multi-range power supplies automatically recalculate voltage and current limits for each setting, providing full output power in any Volt/Amp combination within the rated voltage and current limits.

Model		9115	9115-AT	9116	9117
Output ratings	Voltage	80 V		150 V	80 V
	Current	60 A		30 A	120 A
	Power	1200 W			3000 W
Load regulation	Voltage	0.01 % + 5 mV		0.05 % + 30 mV	
	Current	0.1 % + 10 mA		0.1 % + 30 mA	
Ripple (20 Hz - 20 MHz)	Voltage	≤ 60 mVpp			≤ 80 mVpp
	Current	100 mArms		40 mArms	120 mArms
Programming/Readback accuracy	Voltage	0.02 % + 30 mV		0.05 % + 30 mV	
	Current	0.1 % + 60 mA		0.2 % + 30 mA	

Features & Benefits

- Multi-range operation
- Compact, high density, 1U rackmount form factor (2U for 9117)
- High programming and readback resolution
- Adjustable voltage slope (rise and fall times)
- Sequence programming (internal list mode for models 9115, 9115-AT, and 9116)
- Standard USB (USBTMC-compliant), RS232, GPIB, RS485, and LAN (9117 only) interfaces supporting SCPI commands for remote control
- Analog interface with control and monitoring functions
- Overvoltage protection (OVP), overpower protection (OPP), overtemperature protection (OTP), and key-lock function

Model 9115-AT automotive test functions

The 9115-AT provides automotive power test waveforms compliant to DIN 40839 and ISO 16750-2 standards that can simulate common test conditions for electrical and electronic devices installed in automobiles.

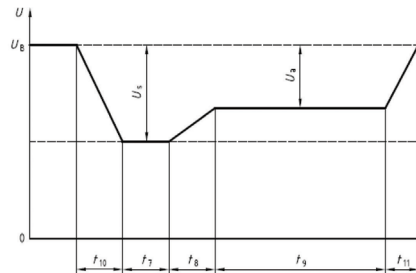

Motor startup curve test

B&K Precision's application software for selected power supplies integrate with National Instrument's NI Data Dashboard for LabVIEW, allowing you to remotely monitor your power supply on iOS, Android, or Windows 8 compatible tablets or smartphones. This app enables users to quickly develop a custom dashboard consisting of one or several indicators, charts, or gauges.



Supports NI Data Dashboard for LabVIEW

Power Supplies

General Purpose - Triple Output

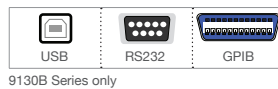

9129B & 9130B Series Triple Output DC Power Supplies

These triple output linear programmable DC power supplies feature isolated outputs that can be adjusted independently or combined in series or parallel to output higher voltage or current. Additionally, these supplies can operate in tracking mode with user-configurable ratios between channels.

Users can control the power supplies using SCPI command or via the provided application software, which supports test sequence generation and logging.

Model		9129B	9130B	9131B	9132B
Output ratings	Ch1 & Ch2	30 V, 3 A	30 V, 3 A	30 V, 6 A	60 V, 3 A
	Ch3	5 V, 3 A	5 V, 3 A	5 V, 3 A	5 V, 3 A
	Power	195 W	195 W	375 W	375 W
Ripple and noise	Voltage	$\leq 5 \text{ mVp-p} / 1 \text{ mVrms}$		$\leq 1 \text{ mVrms}$	
	Current	$\leq 6 \text{ mArms}$	$\leq 3 \text{ mArms}$	$\leq 5 \text{ mArms (ch1/ch2)}$ $\leq 4 \text{ mArms (ch3)}$	$\leq 4 \text{ mArms}$
Programming resolution	Voltage	10 mV / 1 mA			1 mV / 1 mA
	Current	10 mV / 1 mA			1 mV / 1 mA
Load regulation	CV	$\leq 0.02\% + 4 \text{ mV}$		$\leq 0.01\% + 3 \text{ mV}$	
	CC	$\leq 0.2\% + 3 \text{ mA}$		$\leq 0.1\% + 3 \text{ mA}$	
Remote interface		USB Adapter	USB (USBTMC), RS232, GPIB		
Memory locations		29	36		
Remote sense		--	√		
Output timer		--	√		

Features & Benefits

- Three independent, fully programmable and electrically isolated outputs
- Tracking mode to adjust voltage and current settings for all channels simultaneously
- Connect any two or all three channels in series or parallel to produce higher voltages or currents
- Low noise, linear regulation
- Standard USB (USBTMC-compliant), RS232, & GPIB interfaces (9130B Series)
- Communicate via USB interface using the included USB to TTL serial adapter (9129B)
- Overshoot protection (OVP) and overtemperature protection (OTP)

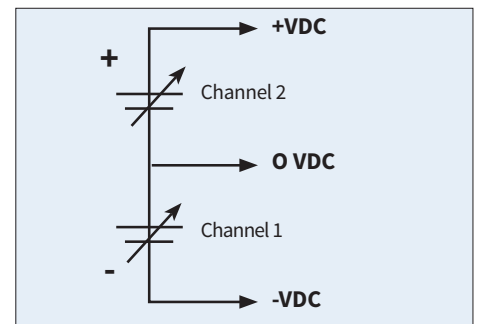

Bipolar output configuration

The independent and isolated outputs can be used to create positive and negative outputs between channels 1 and 2. This feature is useful for powering bipolar circuits and devices.

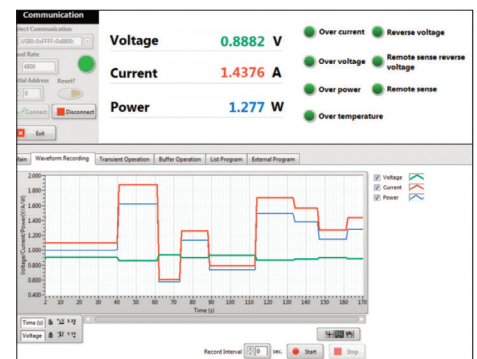

Application software

PC software is provided for front panel emulation, generating and executing test sequences or logging measurement data without the need to write source code.

Power Supplies

General Purpose - Dual & Multi-Range

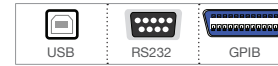

9200 Series Multi-Range Programmable DC Power Supplies

Any 9200 Series model can replace several supplies on your bench or in your rack. Unlike conventional supplies with fixed output ratings, these multi-range power supplies automatically recalculate voltage and current limits for each setting, providing full output power in any Volt/Amp combination within the rated voltage and current limits.

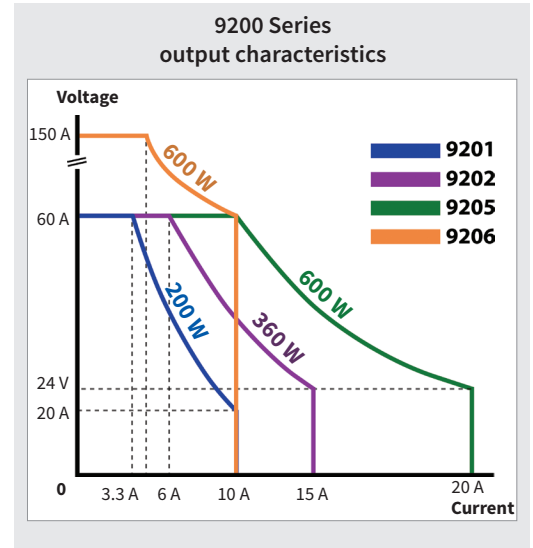
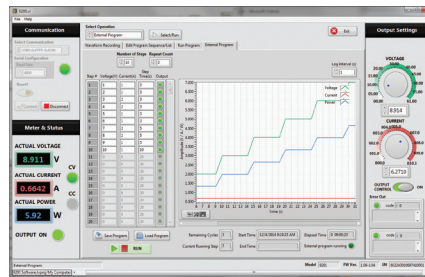

Features & Benefits

- Multi-range operation
- High programming and readback resolution
- List mode programming
- Standard USB, RS232, and GPIB interfaces for remote control
- Remote sense
- Overvoltage protection (OVP), overcurrent protection (OCP), and overtemperature protection (OTP)

Application software

- PC software is provided for front panel emulation, generating and executing test sequences or logging measurement data without the need to write source code.
- Log voltage, current, and power values as well as timestamp, CV/CC mode, and output status
 - Save and load list files to and from the power supply's internal memory or a PC
 - Remote monitoring on iOS, Android, or Windows 8 compatible tablets or smartphones via NI Data

Multi-range operation

Traditional power supplies with rectangular output characteristics are only able to deliver maximum output power at one voltage/current point. The multi-ranging 9200 Series provides greater flexibility over traditional power supplies by extending operating areas. For example, the 9206 can operate at 150 V/4 A, 60 V/10 A, or any other point on the maximum power curve. These wide ranges of voltage and current allow users to replace multiple traditional power supplies on a bench or system rack.

Model		9201	9202	9205	9206
Output ratings	Voltage	60 V	60 V	60 V	150 V
	Current	10 A	15 A	25 A	10 A
	Power	200 W	360 W	600 W	600 W
Load regulation	Voltage	≤ 0.01%+5 mV	≤ 0.01%+8 mV	≤ 0.01%+15 mV	≤ 0.01%+15 mV
	Current	≤ 0.05%+4 mA	≤ 0.05%+6 mA	≤ 0.1%+10 mA	≤ 0.05%+10 mA
Ripple and noise (20 Hz - 20 MHz)	Voltage	≤ 8 mVpp	≤ 15 mVpp	≤ 20 mVpp	≤ 50 mVpp
	Current	≤ 6 mArms	≤ 8 mArms	≤ 15 mArms	≤ 15 mArms
Programming/readback accuracy	Voltage	≤ 0.03%+5 mV	≤ 0.03%+5 mV	≤ 0.03%+5 mV	≤ 0.03%+20 mV
	Current	≤ 0.1%+10 mA	≤ 0.1%+15 mA	≤ 0.1%+25 mA	≤ 0.1%+25 mA

Power Supplies

General Purpose - Dual & Multi-Range



9103 & 9104 Multi-Range DC Power Supplies

This family of efficient and compact DC power supplies offers multi-ranging capabilities, allowing the user to provide higher voltage or higher current compared to conventional power supplies of the same power rating. By providing expanded operational ranges of voltage and current, users can save both money and space by replacing several power supplies with one multi-range power supply.

- Step and ramp programming function
- Analog remote control function USB interface
- Remote sense terminal
- Output on-off switch and control panel lock button for safer operation
- Overvoltage, overtemperature, overload, and short circuit protection

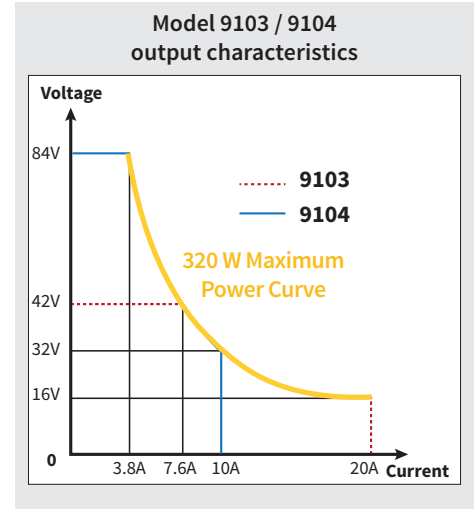

Features & Benefits

- Multi-ranging operation
- Rotary encoder control for precise voltage and current setting
- Save up to 3 user-defined voltage and current presets for quick recall
- Output On/Off control

Model		9103	9104
Variable output voltage		0 – 42 V	0 – 84 V
Variable output current		0 – 20 A	0 – 10 A
Max power		320 W	
Ripple and noise	Voltage	≤80 mVpp / ≤8 mVrms	
	Current	≤200 mA	≤50 mA
Voltage regulation	Load (0-100% rated current)	≤120 mV	≤100 mV
	Line (90-264 VAC variation)	≤10 mV	

1737 & 1747 Dual-Range DC Power Supplies



Model 1747

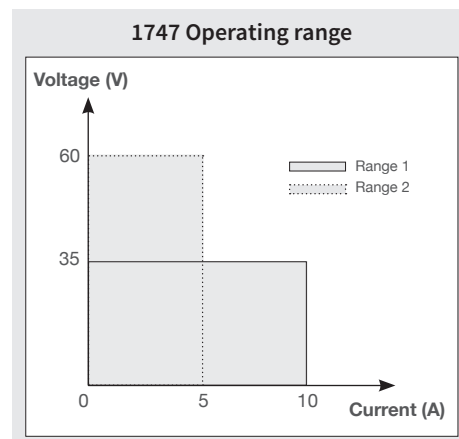

Features & Benefits

- Low ripple and noise
- Excellent regulation
- Constant voltage (CV) and constant current (CC) operation
- Two 4-digit LED displays provide good visibility in bright or low light
- RS232 interface
- Automatic recall of last settings on power up

Power (W)	Voltage (V)		Current (A)		Ripple & Noise	Model
	Range 1	Range 2	Range 1	Range 2		
90 / 120	0 - 30	0 - 60	0 - 3	0 - 2	1 mVrms	1737
350 / 300	0 - 35	0 - 60	0 - 10	0 - 5	1 mVrms	1747

Power Supplies

General Purpose - Single Output

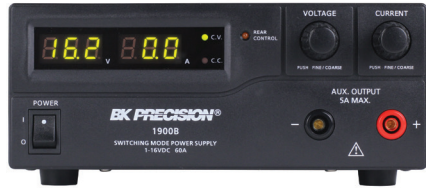

1685B Series & 1900B Series Switching DC Power Supplies

Models 1685B, 1687B, 1688B, 1900B, 1901B and 1902B are laboratory grade switching DC power supplies with high current output in a small, lightweight form factor. They provide various configurations of high output voltage or high output current and feature rotary encoder control knobs, which make setting voltage and current fast and precise. Dual action push buttons allow the user to set both coarse and fine, voltage and current levels.

Features & Benefits

- Automatic CV (constant voltage)/ CC (constant current) crossover operation
- Lightweight and compact
- Rotary encoder control for precise voltage and current setting
- Save up to 3 user-defined voltage and current presets for quick recall
- Analog remote control function
- Remote sensing terminal (model 1900B)
- Overvoltage, overtemperature, and overload protection
- USB interface with PC software for remote control and external timed programming

Power (W)	Voltage (V)	Current (A)	Ripple & noise (mVpp)	Weight	Dimensions (W x H x D)	Model
300	1-60	0-5	50	2.4 kg	200 x 90 x 208 mm	1685B
360	1-36	0-10				1687B
360	1-18	0-20				1688B
900	1-60	0-15	100	3.2 kg	200 x 90 x 275 mm	1902B*
960	1-16	0-60	50			1900B*
960	1-32	0-30	1901B*			

* Order model 190x-220 V for 220 V AC input configuration

Programmable DC Supplies



Models 1785B, 1786B, 1787B, and 1788 are programmable DC power supplies offering a new level of "ease-of-use" and programmability in a low-cost package.

Features & Benefits

- 16 user programmable preset outputs
- Controllable output On/Off switch
- Communicate via USB interface using the included USB to TTL serial adapter
- 10 mV/10 mA display resolution
- Bright VFD display
- Closed case calibration for simple, uninterrupted operation low ripple and noise
- Excellent temperature stability
- Serial interface cable and remote control software included
- OVP, OCP, and OTP protection

Power (W)	Voltage (V)	Current (A)	Interface	Weight	Dimensions (W x H x D)	Model
90	0-18	0-5	USB*	5 kg	214.5 x 88.2 x 354.6 mm	1785B
96	0-32	0-3				1786B
108	0-72	0-1.5				1787B
192	0-32	0-6				1788

*USB to TTL serial adapter

Power Supplies

General Purpose - Single Output



Model 9151



Model 9120A

9120A & 9150A Series Programmable Power Supplies

The 9120A and 9150 Series are high performance linear-regulated programmable DC power supplies that provide excellent performance and features not found in other power supplies of the same price category.

These power supplies are designed for applications in design verification, production testing, or university labs where the user requires clean, reliable power combined with high resolution/accuracy and a fast transient response time.

The series' digital port offers a variety of configurations. The port provides Digital Input, external Trigger and Remote Inhibit (RI) functionality. The RI mode can be used for turning several power supplies On/Off simultaneously.

Application software

The included application software supports front panel emulation and allows users to generate simple test sequences without the need to write source code.

QuickSet Program AutoTest			
ID	Voltage(V)	Current(A)	Delay
1	5	5	1
2	10	5	3
3	15	5	4
4	18	5	2
5	21	5	3
6	1	5	4
7	5	5	2
8	15	5	1
9	20	5	2
10	18.5923	1.2593	1

Software test sequence setup

Features & Benefits

- Very low ripple and noise due to linear regulation
- Excellent display resolution
- Fast transient response time (<150 μs all models)
- Programmable via USB using SCPI compatible command set
- List mode operation for increased throughput
- Intelligent fan speed control for quiet operation
- For bench use or rack mountable
- Closed case calibration
- Built-in 5 1/2 digit DVM and milliohm meter supporting 4 wire measurements.

Power (W)	Voltage (V)	Current (A)	Load regulation	Ripple & noise	Weight	Dimensions	Model
86.4	0-72 V	0-1.2 A	<0.01% +2 mV <0.05% +0.3 mA	≤ 5 mVpp	9 kg	214.5 x 88.2 x 354.6 mm	9124
96	0-32 V	0-3 A	<0.01% + 2 mV <0.05% +1 mA	≤ 4 mVpp			9120A
100	0-20 V	0-5 A	<0.01% + 2 mV <0.05% +0.5 mA	≤ 3 mVpp			9121A
150	0-60 V	0-2.5 A	<0.01% + 2 mV <0.05% +0.5 mA	≤ 5 mVpp	9.6 kg	214.5 x 88.2 x 354.6 mm	9122A
150	0-30 V	0-5 A	<0.01% + 2 mV <0.05% +1.5 mA	≤ 4 mVpp			9123A
540	0-20 V	0-27 A	<0.01% +1 mV <0.1% +5 mA	0.005% + 3 mVpp	29 kg	429 x 88.2 x 458.9 mm	9151
540	0-30 V	0-18 A					9152

Power Supplies

General Purpose - Single Output

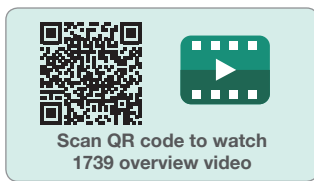

1739 30V/1A Low Current High Resolution DC Power Supply

The B&K Precision model 1739 is a high resolution, low current DC power source that exhibits excellent regulation and low ripple characteristics. This power supply is well suited for electrical and electronics applications requiring precise levels of low current including 4-20 mA current loop testing and calibration.

Features & Benefits

- Low current ripple and noise (<0.4 mArms)
- Low 1 mA settable current limit with 0.1 mA resolution
- Output on/off button
- LED indication for CV and CC modes
- Automatic recall of saved voltage and current settings upon power up
- RS232 interface
- Power-on self test

1696 Series Programmable DC Switching Power Supplies



The 1696, 1697, and 1698 DC switching mode programmable power supplies generate 200 W of output power at a lower cost than traditional linear power supplies.

The RS232 interface allows you to remotely control the power supply or program a sequence of different voltages and current limits that can be used in an automated test application.

Features & Benefits

- RS232 interface standard
- Application software providing data logging capability
- Output on/off button
- Over voltage protection
- Constant voltage and constant current (current limiting) operation
- Large easy-to-read LCD displays

Power (W)	Voltage (V)	Current (A)	Interface	Display (meter)	Ripple & noise (mVrms)	Weight	Dimensions (W x H x D)	Model
27	30	0-0.9	RS232	Dual 4-digit LED	1	4 kg	140 x 158 x 318 mm	1739
198	1-60	0-3.3	RS232, RS485*	4-digit display ammeter, voltmeter, and power meter	25 mVpp	3 kg	193 x 98 x 215 mm	1698
200	1-20	10						1696
200	1-40	0-5						1697

*via optional RS232 to RS485 adapter

Power Supply
Guide

BK PRECISION

Power Supply Guide

Introduction to different power supply types and the technology behind them, plus related terms, specifications and usage examples.

For more guides and applications, visit: bkprecision.com/product-applications

Power Supplies

Basic & Education



Battery Eliminators

These power supplies provide a fixed voltage output and are intended to replace a battery. They are inexpensive and handy for anyone who needs to work on battery-operated equipment without having to find the required batteries.

CV Power Supplies

Constant voltage (CV) power supplies allow users to adjust the voltage and are usually supplied with a meter to show the set voltage. Some CV supplies also include meters to monitor the current such as the 1686A. The supply's behavior is to maintain the set voltage regardless of the load's resistance.

CV/CC Power Supplies

Constant voltage/constant current (CV/CC) power supplies are one of the most popular types of power supplies. These supplies allow users to adjust both the voltage and current. Similar to constant voltage mode where the set voltage is maintained, when in constant current mode, the power supply will maintain the set current regardless of the load's resistance.

Power (W)	Voltage (V)	Current (A)	Display (meter)	Number of outputs	Type	Weight	Dimensions (W x H x D)	Model
12 W	3.3 V/4.5 V/6 V/7.5 V/9 V/12 V (fixed)	1 A	None	1	Battery eliminator	0.4 kg	88.9 x 50.8 x 139.7 mm	1513
30 W	0-30 V	0-1 A	Dual Analog		CV/CC mode supply	3.6 kg	140 x 158 x 318 mm	1710A*
36 W	3.3 V/4.5 V/6 V/7.5 V/9 V/12 V (fixed)	3 A	None		Battery eliminator	0.4 kg	88.9 x 50.8 x 139.7 mm	1514
55 W	13.8 V (Fixed)	4 A	None			2.65 kg	92 x 160 x 170 mm	1680
90 W	0-18 V	0-5 A	Dual 3-digit LED			7.4 kg	115 x 205 x 270 mm	1621A
90 W	0-60 V	0-1.5 A			1623A			
90 W	0-30 V	0-3 A			1627A			
90 W	0-30 V	0-3 A	Dual Analog		CV/CC mode supply	4.7 kg	140 x 158 x 318 mm	1730A*
90 W	0-30 V	0-3 A	Dual 4-digit LED			2 kg	70 x 150 x 250 mm	1735A*
108 W	1-36 V	0-3 A	3-digit display			5.4 kg	140 x 158 x 318 mm	1550
120 W	0-60 V	0-2 A	Dual 4-digit LED			6.75 kg	124 x 216 x 292 mm	1715A*
166 W	13.8 V (Fixed)	12 A	None		Battery eliminator	5.45 kg	124 x 216 x 292 mm	1682A
168 W	14 V	12 A @ 14 V	Dual Analog		CV mode supply			1686A
200 W	1-20 V	0-10 A	Dual 3½-digit LED					1665
200 W	1-40 V	0-5 A	Dual 3-digit LED		CV/CC mode supply	3 kg	203 x 114 x 274 mm	1666
198 W	1-60 V	0-3.3 A			1667			
600 W	3-15 V	40 A			1692			
900 W	1-15 V	60 A			1693			
900 W	30 V	30 A			CV mode supply	5.8 kg	220 x 110 x 300 mm	1694

*CuL

Power Supplies

Basic & Education



Multi-Range DC Power Supplies

Models 9110 and 9111 are a new type of power supply. Unlike conventional power supplies with fixed output ratings, they automatically recalculate voltage and current limits for each setting, providing any Volt/ Amp combination within the rated power

- Output rating up to 180 W within 60 V/ 8 A (9111) or 100 W within 60 V/ 5 A (9110)
- Digitally controlled, multi-ranging output
- 10 mV/1 mA resolution over the full range

Triple Output DC Power Supplies

The 1651A and 1652 triple output DC power supplies offer two variable 0 - 24 V/ 0 – 500 mA outputs, and one fixed 5 V/ 0 – 4 A output in a compact package.

The 1760A, 1761, and 1762 triple output DC power supplies offer three independent outputs with two 4-digit LED displays and 10 mV/1 mA resolution.

Quad Display Triple Output DC Power Supplies

The 1672 and 1673 are quad display triple output DC power supplies that provide two variable outputs and one fixed output.

- Series and parallel tracking
- LED indicator for CV and CC mode

Max. Power	Max. Voltage	Max. Current	Display (meter)	Number of outputs	Type	Weight	Dimensions (W x H x D)	Model
44 W	24 V (A&B), 5 V (Fixed)	0.5 A (A&B), 4 A (Fixed)	Dual analog	3	Triple output CV/CC supply	4.8 kg	298 x 114 x 264 mm	1651A
44 W	24 V (A&B), 5 V (Fixed)	0.5 A (A&B), 4 A (Fixed)	Dual 3-digit LED					1652
98 W	30 V, 12 V (Fixed), 5 V (Fixed)	3 A, 0.5 A, 0.5 A	Dual 3-digit LCD					1670A*
152 W	30 V (A&B), 6.5 V	2 A (A&B), 5 A	Dual 4-digit LED	1	Multi-ranging CV/CC supply	10 kg	267 x 145 x 381 mm	1760A*
100 W	60 V	5 A	Dual 4-digit LED					9110
180 W	60 V	8 A	Dual 4-digit LED	3	Triple output CV/CC supply	6.5 kg	216 x 124 x 242 mm	9111
158 W	30 V, 12 V (Fixed), 5 V (Fixed)	5 A, 0.5 A, 0.5 A	Dual 3-digit LCD					1671A
207 W	0-32 V (A&B), 5 V (Fixed)	0-3 A (A&B), 3 A (Fixed)	Quad 3-digit LED					1672*
242 W	35 V (A&B), 6.5 V	3 A (A&B), 5 A	Dual 4-digit LED					1761*
266 W	60 V (A&B), 6.5 V	2 A (A&B), 5 A	Dual 4-digit LED					1762
399 W	0-32 V (A&B), 5 V (Fixed)	0-6 A (A&B), 3 A (Fixed)	Quad 3-digit LED			9.0 kg	230 x 170 x 310 mm	1673

*CuL approved

Power Supplies

Programmable AC Sources



NEW

9830 Series Programmable AC Power Source

The 9830 Series are low distortion, single-phase AC power sources delivering a maximum of 3000 VA, 300 Vrms, 30 Arms / 97.5 Apk with the output frequency adjustable from 45 Hz – 120 Hz. Housed in a compact 3U form factor, the AC source is capable of generating both AC, DC, and AC+DC output.



Features & Benefits

- Measurements: Vrms, Arms, Vdc, +Apk, -Apk, inrush current, frequency, power factor, apparent power, reactive power, true power, and crest factor
- All measurements can be displayed simultaneously on a large and bright 4.3" color LCD

Measure		Output On	
300.00 Vrms	10.00 Arms	Program	
60.00 Hz	3012.00 W	Configure	
V _{pp} 424.30	S (VA) 0.00	System	
+Apk 0.00	Q (VAR) 0.00	Display 2 of 3	
-Apk 0.00	CF 0.00		
Inrush (A) 0.00	PF 0.00		
Output Timer: 00:00:00			

Measurement display

- Power line disturbance simulation functions using STEP, LIST, and Pulse modes
- Adjustable phase angle control
- Analog input control with a maximum bandwidth of 1.2 kHz
- Save setups and waveform data to USB flash drive
- 4 built-in predefined harmonic distortion waveforms
- Generate custom arbitrary waveforms on a PC then download and execute waveforms from the power supply's internal memory
- List mode with 10 user-defined programs with up to 100 programmable steps each
- Digital I/O port for external triggering, action completed indicator, failure status indicator, and remote inhibit
- Comprehensive protection modes including OVP, OCP, OTP, fan failure, and key lock

Applications

- Pre-compliance testing according to IEC61000-3-2
- Evaluating transformers, TRIACs, SCRs, and passive components
- Simulating common power grid faults and disturbances

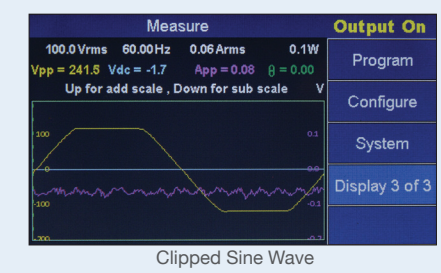

Clipped Sine Wave

Model	9832	9833
Max power	2000 VA	3000 VA
Max voltage (rms)	AC	150 V / 300 V
	DC	±212 V / ±424 V
Max current (rms)	0 – 150 V	20 A
	0 – 300 V	10 A
Frequency range	45 – 1200 Hz	
Load regulation	≤ 0.1 % FS (resistive load)	
Total harmonic distortion (THD)	≤ 0.5 % at 45 - 400 Hz (resistive load)	
Remote interface	USB (USBTMC-compliant), GPIB, and LAN	

ElectriKit



A helpful tool for electricians, technicians, engineers, students, hobbyists and anyone dealing with electrical power.

Key Features

- Calculate DC power and single- or three-phase AC true power, reactive power, and apparent power
- Delta-wye transformation calculator
- AWG size calculator to determine wire diameter, cross-sectional area, and resistance
- Voltage drop calculator
- Ampacity table for insulated conductors per NEC Table 310.16



Power Supplies

Power Meter



5335B Power Meter

The 5335B is a compact, single-phase AC power meter for measuring and analyzing energy consumption and power quality up to 600 Vrms, 20 Arms, and bandwidth of 100 kHz.

Applications

Measure power, electric energy bought or sold back to the power grid, standby power, and harmonics of motors, uninterruptable power supplies, battery chargers, appliances, and consumer electronics.

Features & Benefits

- 4.3-inch color TFT LCD
- Simultaneously measure and display up to 12 AC and DC parameters
- Front panel USB host port for data storage to a USB flash drive
- Standard USB (USBTMC), RS232, and LAN interfaces
- Integration function with automatic range switching for measuring electric energy
- External current sensor interface for measurements above 20 A
- Total harmonic distortion (THD) and harmonic measurements up to the 50th harmonic with the ability to display individual harmonic components

Key Specifications		
Basic voltage and current accuracy	$\pm(0.1\% \text{ of reading} + 0.2\% \text{ of range})$	
Measurement range	Voltage	0 - 600 Vrms
	Current	0 - 20 Arms
Input bandwidth	DC, 0.5 Hz - 100 kHz	
Measurements	Voltage, Current, Active power, Reactive power, Apparent power, Power factor, Phase difference, Frequency, V Max/V Min, A Max/A Min, Crest factor, Integration, Harmonic distortion factor, Total harmonic, distortion (THD)	
Voltage and current accuracy	DC: $\pm(0.1\% \text{ of reading} + 0.2\% \text{ of range})$ 0.5 Hz $\leq f < 45$ Hz: $\pm(0.1\% \text{ of reading} + 0.2\% \text{ of range})$ 45 Hz $\leq f < 66$ Hz: $\pm(0.1\% \text{ of reading} + 0.2\% \text{ of range})$ 66 Hz $\leq f < 1$ kHz: $\pm(0.1\% \text{ of reading} + 0.2\% \text{ of range})$ 1 kHz $\leq f < 10$ kHz: $\pm(0.1\% \text{ of reading} + 0.2\% \text{ of range})$ $\pm(0.07 \times f)\%$ of reading + 0.3% of range 10 kHz $\leq f < 100$ kHz: $\pm(0.5\% \text{ of reading} + 0.5\% \text{ of range})$ $\pm\{[0.04 \times (f - 10)]\%$ of reading]	
Active power accuracy	DC: $\pm(0.1\% \text{ of reading} + 0.2\% \text{ of range})$ 0.5 Hz $\leq f < 45$ Hz: $\pm(0.3\% \text{ of reading} + 0.2\% \text{ of range})$ 45 Hz $\leq f < 66$ Hz: $\pm(0.1\% \text{ of reading} + 0.1\% \text{ of range})$ 66 Hz $\leq f < 1$ kHz: $\pm(0.2\% \text{ of reading} + 0.2\% \text{ of range})$ 1 kHz $\leq f < 10$ kHz: $\pm(0.1\% \text{ of reading} + 0.3\% \text{ of range})$ $\pm\{[0.067 \times (f - 1)]\%$ of reading]	
	10 kHz $\leq f < 100$ kHz: $\pm(0.5\% \text{ of reading} + 0.5\% \text{ of range})$ $\pm\{[0.09 \times (f - 10)]\%$ of reading]	

Harmonic histogram



The parameters of each harmonic measured can be displayed in a bar chart.

Harmonic measurement

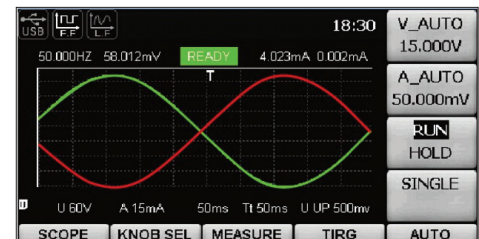

The power meter can display the waveform based on sampling data for quick analysis of measurement results.

Power Supplies

AC Sources



9800 Series Programmable AC Power Sources

The 9800 Series is both a programmable AC source and measurement tool. These fully programmable linear AC sources deliver a maximum of 1500 VA through the universal line output terminals on the front and the output connector on the rear. The output can be varied from 0 to 300 V with 0.1 V programming resolution. The output frequency can also be adjusted from 45 Hz to 500 Hz with start and stop phase angle from 0 to 360 degrees. The bright VFD display shows Vrms, Irms, Ipeak, frequency, power factor (PF), apparent power, true power, and elapsed output time.

Power line disturbance (PLD) simulator

The PLD simulator is an extended feature of list mode that provides the user with more control over the disturbance insertion into the waveform. This can be useful for evaluating a product's immunity performance. For instance, a user could produce common waveform disturbances like surge, sag, spikes, and dropouts at user-defined locations on the waveform.

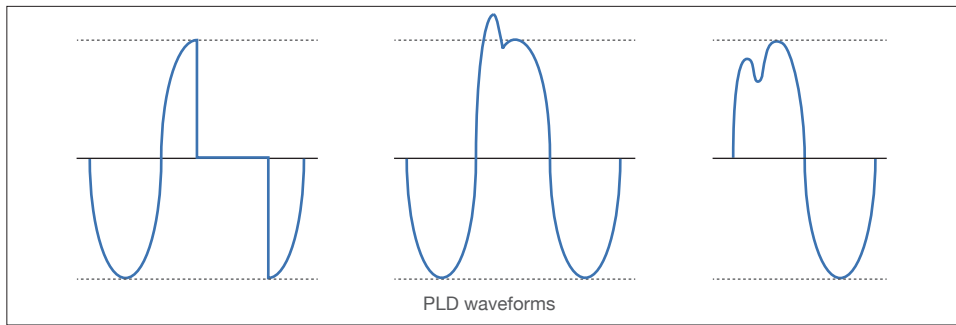

* 9803 and 9805 only

Features & Benefits

- 0 to 300 V, low distortion AC power source with models delivering a maximum of 1500 VA, 12 Arms / 48 A peak
- Output frequency adjustable from 45 Hz – 500 Hz
- Select 150 V / 300 V autoranging or 300 V range operation for continuous sweep from 0 - 300 V
- Displays Vrms, Irms, Ipeak, frequency, PF, apparent power, true power, and elapsed output time
- Adjustable phase angle control
- Programmable voltage and frequency limit settings
- Power line disturbance simulation function
- Standard USB, RS232, and LAN interfaces supporting SCPI commands for remote control
- Standard GPIB interface (9803 & 9805)

Model	AC Output							AC Input		Dimensions (W x H x D)
	Max power	Max current (rms)	Max current (peak)	Total harmonic distortion	Crest factor	Line regulation	Load regulation	Voltage	Max current	
9801	300 VA	3 A (0-150 V), 1.5 A (0-300 V)	12 A (0-150 V), 6 A (0-300 V)	≤ 0.5% at 45-400 Hz (resistive load)	≥ 4	0.1% max for a ±10% line change	≤ 0.5% FS (resistive load)	110/220 VAC ±10%	30 A	214.5 x 88.2 x 453.5 mm
9802	750 VA	6 A (0-150 V), 3 A (0-300 V)	24 A (0-150 V), 12 A (0-300 V)						15 A	439 x 131.4 x 535.7 mm
9803	1500 VA	12 A (0-150 V), 6 A (0-300 V)	48 A (0-150 V), 24 A (0-300 V)						8 A	439 x 131.4 x 535.7 mm



1653A & 1655A AC Power Supplies

The 1653A and 1655A variable isolated AC power supplies are great for testing AC line voltage variations or any given product requiring AC power.

- Variable isolated 0 to 150 VAC
- 2 A (1653A) and 3 A (1655A) continuous output

Additional features (1655A only)

- Built-in soldering iron temperature control
- Expanded leakage scale
- Circuit breaker overload protection

DC ELECTRONIC LOADS

Unique solutions for DC power testing



DC Electronic Loads

Selection Table

Category	Basic	Value			Performance		
Model / Series	8540	8500			8600	SDL	MDL
Channel	Single Channel						Multi Channel
Products in this Category	1	4	6	3	8	6	7 modules
Power Range	150 W	300 - 600 W	1200 - 5000 W	150 - 250 W	750 - 6000 W	4 kW - 8 kW	200 - 600 W ⁽¹⁾
Channels	1	1	1	1	1	1	1 - 16 ⁽¹⁾
Settings							
CV, CC, CR	√	√	√	√	√	√	√
CW		√	√	√	√	√	√
CZ							√
Limits							
Max Current		√	√	√	√	√	√
Max Voltage		√	√	√	√	√	√
Max Power		√	√	√	√	√	√
Protection							
OVP, OCP	√	√	√	√	√	√	√
OPP, OTP		√	√	√	√	√	√
Reverse Voltage		√	√	√	√	√	√
Oscillation Detection/Prevention						√	
Features							
List Mode	√√	√	√	√	√	√	√
Remote Sense		√	√	√	√	√	√
Master / Slave Mode						√	
Voltage-on (Von) Latch		√	√	√	√		√
External Analog Control & Monitor				√	√	√ ⁽²⁾	√
Adjustable Slew Rate				√	√	√	√
Trigger	Manual		√	√	√	√	√
	Bus		√	√	√	√	√
	External		√	√	√	√	√
	Timer				√	√	√
	Hold						√
Built-in Tests							
Short Operation	√	√	√	√	√	√	√
Battery Discharge		√	√	√	√		
CR LED				√	√		
Remote Interface							
USB		√	√	√	√	√	√
RS232		√	√	√	√	√	√
GPIB				√	√	√	√
LAN						√	√
Software							
Front Panel Emulation		√	√	√	√	√	√
NI Certified LabVIEW Drivers		√	√	√	√	√	√
NI Data Dashboard				√	√	√	√

√√ Must have firmware version 1.60 or above

⁽¹⁾ Up to 4800 W max power with fully populated MDL001 with MDL002 mainframe extension. Up to 16 channels when using dual input modules

⁽²⁾ Only the SDL Series offers an analog interface that is isolated

DC Electronic Loads

Modular - MDL Series



MDL Series Modular Programmable DC Electronic Loads

The MDL Series consists of a mainframe and seven different modules ranging in power from 200 W to 600 W. Using a modular, multi-channel design, the electronic load provides you with the flexibility to test a wide range of applications from multi-output DC power supplies to batteries, fuel cells, and photovoltaics. The mainframe has four slots and can be configured with any assortment of the modules up to 2400 W (up to 4800 W with mainframe extension).

The high-performance electronic load modules of the MDL Series are capable of operating in CC (constant current), CV (constant voltage), CR (constant resistance), CW (constant power), and CZ (constant impedance) mode.

For remote communication, the electronic load provides LAN, USBTMC-compliant USB, RS232, and GPIB standard interfaces that support SCPI command protocol.

Features & Benefits

- Power range up to 2400 W
- Voltage range up to 500 V
- Current range up to 120 A
- CC, CV, CR, CW, and CZ modes
- Adjustable slew rate in CC mode
- Removable modules for easy system configurability
- Bright VFD display for both mainframe and modules
- Transient mode up to 25 kHz
- List mode up to 100 kHz
- Measurement speed up to 50 kHz
- 101 memory areas to save/recall setting parameters
- Remote sensing
- LAN, GPIB, USBTMC-compliant USB, and RS232 interfaces with SCPI protocol support
- OVP/OCP/OPP/OTP protection
- LRV (Local Reverse Voltage) and RRV (Remote Reverse Voltage) protection

Adjustable slew rate

In constant current mode, users can control the rate or slope of the change in current in a transient response test. Set the slew rate to as slow as 0.0001 A/ μ s or as fast as 2.5 A/ μ s depending on the module and selected current range.

Transient operation

Transient operation enables the module to periodically switch between two load levels to test a power supply's regulation and transient characteristic.

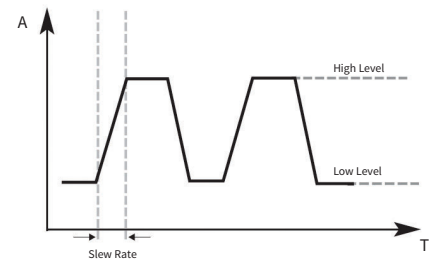

List mode

List mode lets you generate more complex sequences of input changes with several different levels.

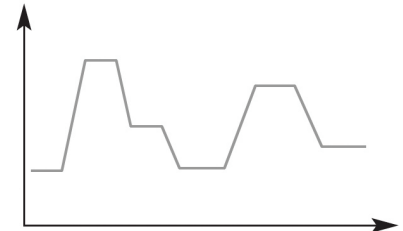

Power	Input voltage	Input current		No. of channels	CC mode accuracy		CV mode accuracy		Model	
		Low range	High range		Low range	High range	Low range	High range		
200 W	80 V	0-4	0-40	1					MDL200	
*250 W / 50 W	Ch1 80 V/ Ch2 80 V	0-3 A	0-20 A	2				$\pm(0.05\% + 0.025\% \text{ F.S.})$	MDL252	
*300 W / 300 W		0-4.5	0-45 A						$\pm(0.05\% + 0.02\% \text{ F.S.})$	MDL302
300 W	500 V	0-3 A	0-20 A	1	$\pm(0.05\% + 0.05\% \text{ F.S.})$	$\pm(0.05\% + 0.05\% \text{ F.S.})$	$\pm(0.05\% + 0.02\% \text{ F.S.})$		MDL305	
400 W	80 V	0-6 A	0-60 A							
500 W	500 V	0-3 A	0-30 A						$\pm(0.05\% + 0.025\% \text{ F.S.})$	MDL505
600 W	80 V	0-12 A	0-120 A			$\pm(0.05\% + 0.1\% \text{ F.S.})$	$\pm(0.05\% + 0.1\% \text{ F.S.})$			MDL600

* The MDL252 and MDL302 are dual-channel modules. MDL252 users can allocate 250 W to either channel up to 300 W total (e.g. 50 W/250 W, 250 W/50 W, 150 W/150 W). MDL302 users can allocate 300 W to either channel up to 600 W total (e.g. 300 W/300 W).

DC Electronic Loads

Modular - MDL Series

MDL302 Dual-Channel Module



The MDL302 can support a full 300 W on each input channel with a voltage and current operating range up to 80 V/45 A, or 600 W combined, offering the industry's highest power dual-channel DC load module.

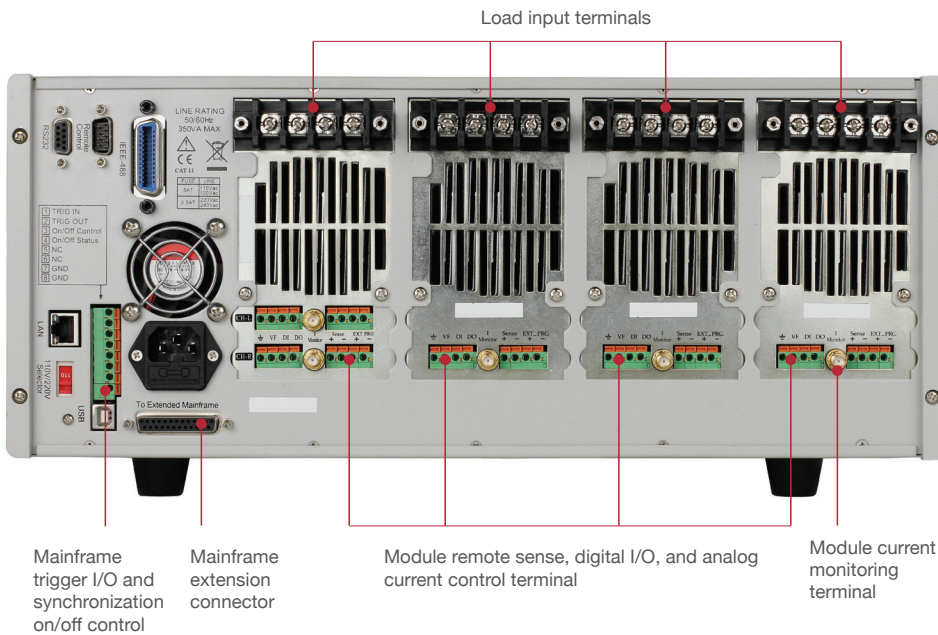

Low Voltage Operation

The MDL series can operate at low voltages for applications such as fuel cell and solar cell testing.

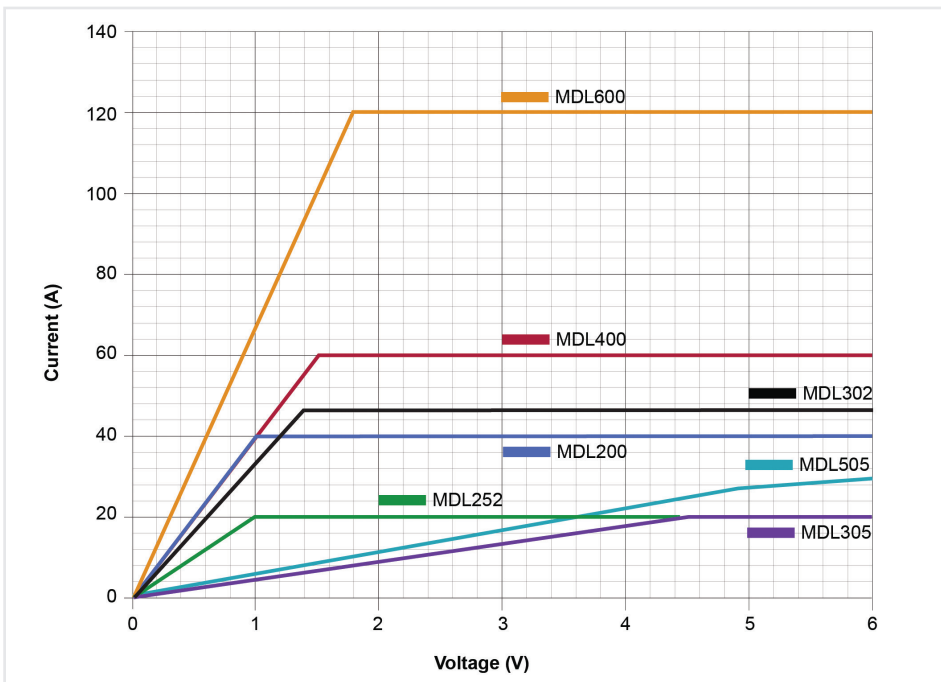

Typical minimum operating voltage at full scale current:

MDL200	MDL252	MDL302	MDL305	MDL400	MDL505	MDL600
1 V	1 V	1.4 V	4.5 V	1.5 V	5.4 V	1.8 V



Install up to 8 MDL302 modules into the MDL Series mainframe with extension for a total of 16 x 300 W channels. The load modules can be used independently or synchronized and paralleled for increased current and power.

Key Specifications		
Input voltage	0 – 80 V	
Input current	Low	0 – 4.5 A
	High	0 – 45 A
Input power	300 W (CH1) / 300 W (CH2)	
Transient operation (CC mode)	Up to 25 kHz	
CC mode (low range)	Resolution	1 mV
	Accuracy	± (0.05 % + 0.025 % F.S.)
Protection modes	OVP/OCP/OPP/OTP	

DC Electronic Loads

Stand-Alone Programmable



Application software

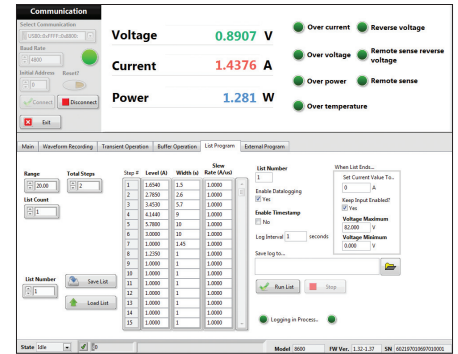

8600 Series Programmable DC Electronic Loads

The 8600 Series programmable DC electronic loads provide the performance of modular system DC electronic loads in a compact benchtop form factor. With fast transient operation speeds up to 25 kHz, and high 16-bit measurement resolution and accuracy, these DC loads can be used for testing and evaluating a variety of DC sources such as DC power supplies, DC-DC converters, batteries, battery chargers, and photovoltaic arrays.

Special Applications

The 8600 Series provides a built-in battery test mode to measure the ampere-hour (Ah) characteristic of a battery and a unique CR-LED mode to simulate the loading behavior of a typical LED.

Features & Benefits

- CC/CV/CR/CW operating modes
- Measurement speed up to 50 kHz
- Remote sense function
- Transient mode up to 25 kHz in CC mode
- List mode function
- Adjustable slew rate in CC mode
- Store and recall up to 100 setups
- Standard RS232, USBTMC, and GPIB interfaces supporting SCPI commands for remote control
- Analog current control and monitoring
- OVP/OCP/OPP/OTP and reverse voltage protection

- Log voltage, current, and power values with timestamp
- Run transient operation and list mode programs remotely
- Create an unlimited number of external list files to be executed from PC memory
- Remote monitoring on iOS, Android or Windows 8 compatible tablets or smartphones via NI Data Dashboard for LabVIEW apps

Input ratings				CC mode accuracy		CC mode resolution		Transient mode (CC mode)		Dimensions	Model	
Voltage (High)	Current (Low)	Current (High)	Power	Low	High	Low	High	T1 & T2	Accuracy			
120 V	3 A	30 A	150 W	$\pm(0.05 + 0.05\%FS)$		0.1 mA	1 mA	20 μ s - 3600 s / Resolution: 10 μ s		218 x 90 x 387 mm (2U half-rack)	8600	
120 V	6 A	60 A	250 W	$\pm(0.05 + 0.05\%FS)$		0.1 mA	1 mA	20 μ s - 3600 s / Resolution: 10 μ s			8601	
500 V	3 A	15 A	200 W	$\pm(0.05 + 0.05\%FS)$		0.1 mA	1 mA	20 μ s - 3600 s / Resolution: 10 μ s			8602	
120 V	12 A	120 A	750 W	$\pm(0.1 + 0.1\%FS)$		1 mA	10 mA	20 μ s - 3600 s / Resolution: 10 μ s		439 x 133.3 x 580 mm (3U)	8610	
500 V	3 A	30 A	750 W	$\pm(0.05 + 0.05\%FS)$		0.1 mA	1 mA	20 μ s - 3600 s / Resolution: 10 μ s			8612	
120 V	24 A	240 A	1500 W	$\pm(0.05 + 0.05\%FS)$		1 mA	10 mA	20 μ s - 3600 s / Resolution: 10 μ s			8614	
500 V	6 A	60 A	1200 W	$\pm(0.05 + 0.05\%FS)$		0.1 mA	1 mA	20 μ s - 3600 s / Resolution: 10 μ s			8616	
120 V	48 A	480 A	3000 W	$\pm(0.025 + 0.05\%FS)$		1 mA	10 mA	20 μ s - 3600 s / Resolution: 10 μ s			8620	
500 V	10 A	100 A	2500 W	$\pm(0.025 + 0.05\%FS)$		1 mA	10 mA	20 μ s - 3600 s / Resolution: 10 μ s			8622	
120 V	60 A	600 A	4500 W	$\pm(0.025 + 0.05\%FS)$		1 mA	10 mA	20 μ s - 3600 s / Resolution: 10 μ s			439 x 266 x 590 mm (6U)	8624
120 V	72 A	720 A	6000 W	$\pm(0.025 + 0.05\%FS)$		1 mA	10 mA	20 μ s - 3600 s / Resolution: 10 μ s				8625

DC Electronic Loads

Stand-Alone Programmable



Automatic test mode

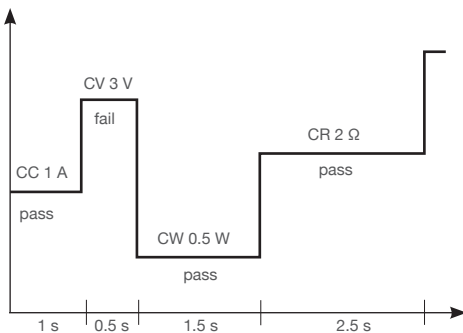

The 8600 Series can execute multiple test sequences in automatic test mode. Up to 100 different sequences can be linked to run steps of various operating modes and loading conditions. Each sequence can also be programmed with upper and lower limit Pass/Fail criteria. When applied in production testing, you can easily judge whether the test parameters of your devices are within the specification limits and adjust your process according to the Pass/Fail verdict.

List mode

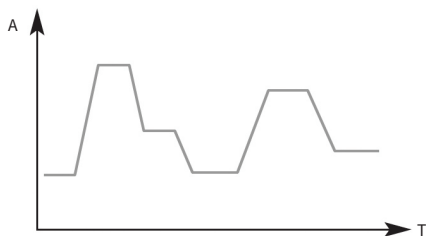

List mode lets you generate more complex sequences of input changes with several different levels. Up to 7 groups of list files can be saved. Each list can contain up to 84 steps with a minimum width time of 20 μ s per step.

Transient operation

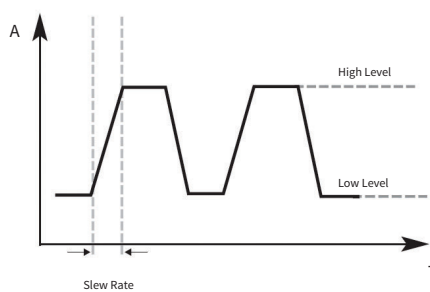

Transient operation enables the module to periodically switch between two load levels. A power supply's regulation and transient characteristic can be evaluated by monitoring the supply's output voltage under varying combinations of load levels, frequency, duty cycle, and slew rate. Transient operation can simulate these conditions.

CR-LED mode

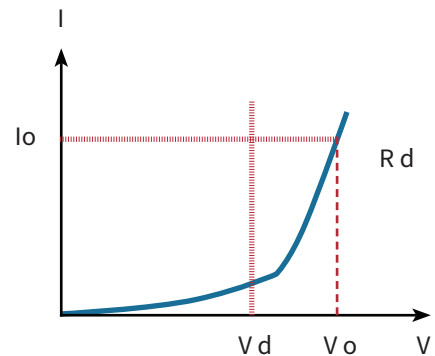

Figure - LED I-V Curve

V_d = Forward voltage of the LED
 R_d = LED's operating resistance
 V_o = Operating voltage across the LED
 I_o = Operating current across the LED

Use the load's unique CR-LED operating mode to test LED drivers. This function allows users to configure the LED's operating resistance and forward voltage along with the voltage range (same as CR operation) to simulate the loading behavior of typical LEDs.



High current test lead accessory Model TLPWR1

- Length: 2 m
- Current: 60 A
- Gauge: 8 AWG
- Material: Flexible Silicon jacket



DC Electronic Loads

Stand-Alone Programmable, High Power Density



SDL Series Programmable DC Electronic Loads

The SDL Series high power/high voltage DC electronic loads offer the industry's highest power density (8 kW in 5U form factor) without sacrificing performance. The DC electronic loads can operate in constant current (CC), constant voltage (CV), constant resistance (CR), and constant power (CW) mode, and provide arbitrary and pulse generator capabilities, analog control, and standard LAN, GPIB, USB, and RS232 interfaces for remote communication.

Special applications

The SDL Series offers a wide operating voltage range up to 1000 V making it ideal for hybrid, plug-in hybrid, and battery electric vehicle (HEV/PHEV/BEV) test applications. Using the built-in arbitrary generator, the DC loads are suitable for DC power bus simulation required for immunity testing.

Comprehensive protection

- Oscillation detection and protection
- Undervoltage lockout for battery discharging and anti-saturation protection
- Ability to select system response bandwidth: Select Fast for maximum transient response speed or Slow for maximum stability
- Cross mode and cross range function to turn off input when a switch in operating mode or range occurs
- Pulse power capability with overpower protection
- Built-in hardware protection: overvoltage, overcurrent, overpower, overtemperature, reverse voltage, remote sense fault, unregulated state, and undervoltage lockout protection
- User-defined overcurrent (OCP), overvoltage (OVP), and overpower (OPP) protection

Features & Benefits

- 0.05% CC mode readback accuracy
- Intelligent PWM fan speed control reduces unnecessary fan noise and optimizes heat management
- 16-bit voltage and current measurement system
- Built in arbitrary and pulse generator for continuous, pulsed, and toggled transient operation
- Highest power density of 1.6 kW per 1U rack space
- Isolated analog control interface
- Flexible ranging options: High and Low, Manual or Auto
- Programmable slew rise and fall time
- Fast 50 μ s transient time in CC mode and 500 μ s in CV mode
- Remote inhibit and dry contact fault output
- Soft-start functionality
- Simple closed-case calibration
- Master/slave capability to increase current by paralleling multiple units with the same voltage rating
- Standard LAN, GPIB, USB, and RS232 interface supporting SCPI commands for remote control

Specifications		4 kW			8 kW		
Models		SDL-600-150	SDL-800-75	SDL-1000-25	SDL-600-300	SDL-800-150	SDL-1000-50
Voltage		600 V	800 V	1000 V	600 V	800 V	1000 V
Current		150 A	75 A	25 A	300 A	150 A	50 A
CC Mode							
Range	Low	0-15 A	0-7.5 A	0-2.5 A	0-30 A	0-15 A	0-5 A
	High	0-150 A	0-75 A	0-25 A	0-300 A	0-150 A	0-50 A
Resolution	Low	0.9375 mA	0.04688 mA	0.1563 mA	1.875 mA	0.9375 mA	0.3125 mA
	High	9.375 mA	4.688 mA	1.563 mA	18.75 mA	9.375 mA	3.125 mA
Programming and readback accuracy		0.05%+0.15 A	0.05%+0.075 A	0.05%+0.025 A	0.05%+0.3 A	0.05%+0.15 A	0.05%+0.05 A
CV Mode							
Range	Low	0-60 V	0-80 V	0-100 V	0-60 V	0-80 V	0-100 V
	High	0-600 V	0-800 V	0-1000 V	0-600 V	0-800 V	0-1000 V
Resolution	Low	3.75 mV	5 mV	6.25 mV	3.75 mV	5 mV	6.25 mV
	High	37.5 mV	50 mV	62.5 mV	37.5 mV	50 mV	62.5 mV
Programming and readback accuracy		0.05%+0.6 V	0.05%+0.8 V	0.05%+1 V	0.05%+0.6 V	0.05%+0.8 V	0.05%+1 V
Transition time	Slow	0.5 ms - 511.9 ms					
	Fast	0.5 ms - 51.19 ms					
Form factor		3U			5U		
Weight		21 kg			33 kg		

DC Electronic Loads

Stand-Alone Programmable /Basic



8500 Series Programmable DC Electronic Loads

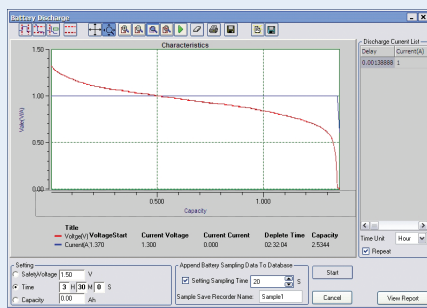

An example of battery discharge characteristics of an AA alkaline battery.

Application software

The included Application Software supports front panel emulation of the load and includes a battery test application which provides Ah rating of a battery and adjustable ending voltage levels (safety voltage).

Features & Benefits

- Constant current (CC), resistance (CR), voltage (CV), and power (CP) operation
- Low minimum operating voltage of < 0.1 V and minimum input resistance of 5 mΩ (model 8518) allow the load to sink high current at low voltages, required for fuel and solar cell applications.
- Built-in transient generator
- Short circuit test
- Overcurrent/overvoltage/overpower/ overtemperature protection
- RS232 & USB to TTL serial converter cable and application software included
- List mode operation for increased throughput
- Battery testing mode to provide Ah rating of battery (cut off voltage level is adjustable)
- Flexible triggering: create trigger events by front panel keystroke, back panel TTL signal, or software
- Remote voltage sensing to compensate for the effect of voltage drop in wires

Operation voltage	Rated current	Max power	Dimensions	Weight	Model
0.1 V-60 V	30 A	150 W	88 x 175 x 282 mm	2.7 kg	8540
0.1 V-120 V	30 A	300 W	215 x 88 x 355 mm	5.2 kg	8500
0.1 V-500 V	15 A	300 W		5.2 kg	8502
0.1 V-120 V	120 A	600 W		14 kg	8510
0.1 V-500 V	30 A	600 W		14 kg	8512
0.1 V-120 V	240 A	1200 W		14 kg	8514
0.1 V-60 V	240 A	1200 W	429 x 88 x 355 mm	14 kg	8518
0.1 V-120 V	240 A	2400 W		30 kg	8520
0.1 V-500 V	120 A	2400 W		30 kg	8522
0.1 V-60 V	240 A	5000 W	444 x 357 x 539 mm	67 kg	8524
0.1 V-500 V	120 A	5000 W		67 kg	8526

150 W DC Electronic Load

The 8540 DC electronic load is a compact, economically priced instrument that can reliably test a 5 V power supply to 30 A and do it continuously.

The 8540's performance is comparable to most stand-alone bench DC loads, yet it does the job at half the price and takes up half the space on your bench.



Features & Benefits

- Operates between 0-60 VDC, 1 mA-30 A (150 W maximum)
- Constant voltage (CV), constant current (CC), and constant resistance (CR) operation
- Very compact and lightweight
- Two current ranges: 3 A (1 mA resolution) and 30 A (10 mA resolution)
- Overcurrent and overvoltage protection

OSCILLOSCOPES

Signal analysis made easy



Digital Storage Oscilloscopes

Bandwidth	Sample rate	Channels	Max memory depth	PC interface	USB host port	Color display	Key features	Model	Page
100 MHz	1 GSa/s	2	40 kpts	USB device, LAN	√	7"	Portable economy oscilloscope for education and design labs on limited budgets, special education mode	2190E	37
70 - 200 MHz	1 GSa/s	2	14 Mpts	USB device, LAN, GPIB (optional)	√	8"	Deep memory up to 14 Mpts, standard arbitrary waveform generator	2540C Series	34
70 - 300 MHz	2 GSa/s	2 or 4	24 kpts	USB device, LAN	√	7"	High bandwidth and sample rate, 4-channel acquisition (select models)	2550 Series	35
70 - 300 MHz	2 GSa/s	2 or 4	140 Mpts	USB device, LAN, GPIB (optional)	√	8"	High-performance oscilloscopes with serial protocol analysis for mixed-signal and embedded design work (standard on -MSO models), 16 digital input channels, high waveform update rate up to 140,000 wfms/s	2560 Series	32 & 33
60 - 100 MHz	1 GSa/s	2	2 Mpts	Mini USB device	√	5.7"	Handheld, floating measurement capabilities, isolated channels for safe measurements in industrial settings (models 2515 and 2516)	2510 Series	36

Analog Oscilloscopes

For users who prefer analog to digital, B&K Precision offers 30 MHz and 60 MHz analog oscilloscopes with simple controls and real-time waveform display.

Bandwidth	Sweep modes	Max sweep rate	Delayed dual / sweep timebase	Component tester	Counter	Model	Page
30 MHz	Main, X-Y	0.1 μs/div	-	-	-	2120C	37
30 MHz	Main, X-Y	0.1 μs/div	-	-	√	2121C	
30 MHz	Main, Mix, Delay, X-Y	0.1 μs/div	√	√	-	2125C	
60 MHz	Main, Mix, Delay, X-Y	0.1 μs/div	√	√	-	2160C	

Oscilloscopes

DSO/MSO



Features & Benefits

- Bandwidth up to 300 MHz
- 2 GSa/s sample rate
- 4-channel acquisition (on select models)
- 16 digital channels with 500 MSa/s sampling rate (enabled with MSO option)
- Large 8" widescreen display with 256-level intensity grading and color temperature display
- Waveform capture rate up to 140,000 wfms/s (normal mode), and 500,000 wfms/s (sequence mode)
- Record length up to 140 Mpts
- High speed hardware-based pass/fail testing function
- 50 Ω input coupling
- Segmented acquisition history waveform record function (record length up to 80,000 frames)
- Trigger types: Edge, Slope, Pulse, Video, Window, Runt, Interval, DropOut, Pattern
- Serial bus triggering and decoding supporting I2C, SPI, UART, RS232, CAN, and LIN protocols (option)
- FFT including seven other math functions: Addition, Subtraction, Multiplication, Division, Integration, Differential, and Square Root
- 37 automatic measurements supporting statistics, gating, math, history, and reference measurements
- Software provided for remote PC control
- Built-in Logic Analyzer (option)
- Built-in AWG (option)

2560 Series Digital Storage and Mixed Signal Oscilloscopes

The 2560 Series includes Digital Signal Oscilloscopes (DSO) and Mixed Signal Oscilloscopes (MSO) from 70 MHz to 300 MHz in 2- and 4-channel configurations. Each model offers 2 GSa/s sample rate, high waveform update rate up to 140,000 waveforms per second, and a maximum memory depth of 140 Mpts. In addition, these instruments provide a large 8" color display with 256 levels of intensity grading, which allow these units to capture and display more details of a signal for analysis. MSO models include a digital logic probe and digital software enabled on the oscilloscope, which provides serial bus triggering and decoding capabilities for I2C, SPI, UART, RS232, CAN, and LIN protocols.

DSO Model	2563	2565	2566	2567	2568	2569
MSO Model	2563-MSO	2565-MSO	2566-MSO	2567-MSO	2568-MSO	2569-MSO
Bandwidth	70 MHz	100 MHz	200 MHz	200 MHz	300 MHz	300 MHz
Channels	4	4	2	4	2	4
Sample rate	2 GSa/s					
Max record length	140 Mpts					
Waveform update rate	140,000 wfms/s					
PC connectivity	Standard LAN (supports SCPI) and USB device port (USBTMC compliant)					
Available Upgrades						
16-channel digital logic probe*	√					
Logic analyzer*	√					
Serial bus decode and analysis package**	√					
25 MHz function/ arbitrary waveform generator	√					



16-channel logic probe and logic analyzer function included with MSO models.

*Standard on MSO model. **Supporting I2C, SPI, UART, RS232, CAN, and LIN Protocols.

Fast waveform capture rate



The 2560 Series delivers up to 140,000 wfms/s update rate to help you detect infrequent anomalies and glitches more quickly.

Logic analyzer

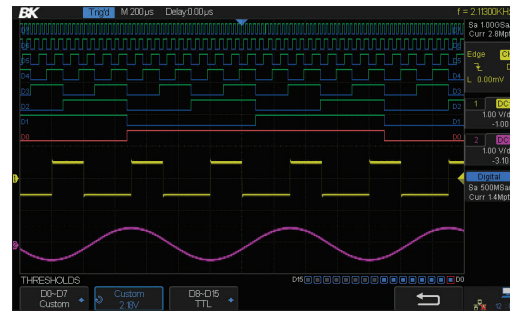

4 analog channels plus 16 digital channels enable users to acquire and trigger on the waveforms, and then analyze the pattern simultaneously with one instrument.

Record length up to 140 Mpts



Using hardware-based Zoom technologies with record lengths of 140 Mpts, users are able to capture more of their signal with higher sampling rates and quickly zoom into the event of interest.

Serial bus decoding

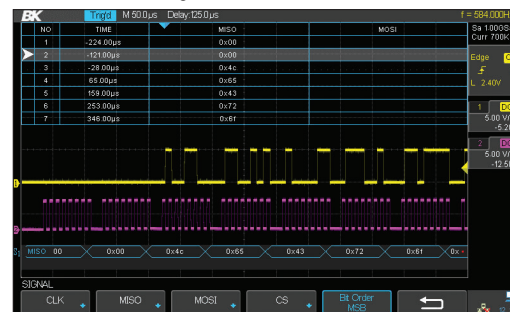

Displays the decoding through the events list. Bus protocol information can be quickly and intuitively displayed in table form.

History and segmented acquisition (Sequence) mode

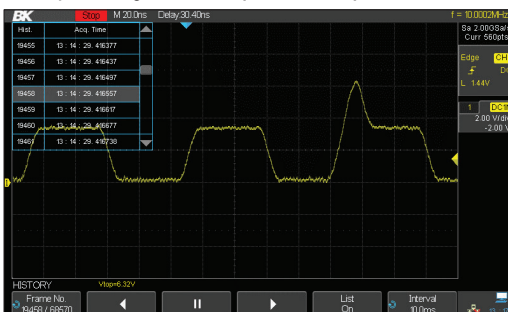

Use the instrument's History and Sequence function to record and play back waveforms to find anomalies and quickly locate the source of the problem via cursor or measurement parameters.

25 MHz function/arbitrary waveform generator



Take advantage of the generator's 10 built-in waveforms or generate up to 4 of your own arbitrary waveforms via waveform editing software.

Comprehensive statistical functions

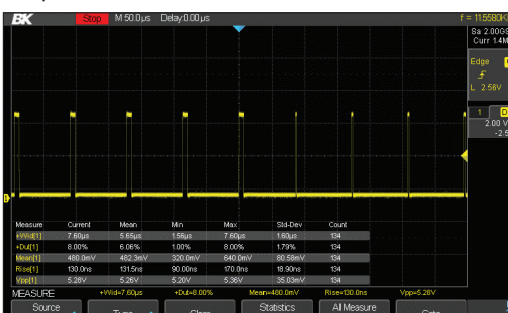

Parametric statistical functions are available for displaying five parameters of any measurement: current value, mean value, minimum value, maximum value, and standard deviation.

Eres (Enhanced Resolution) mode

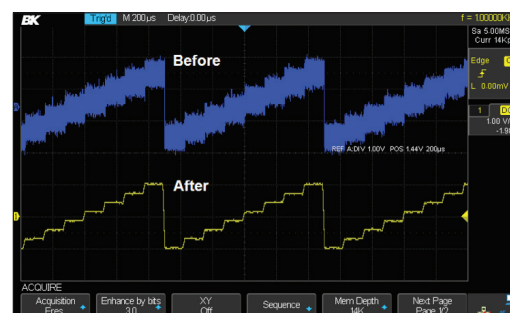

Eres mode can improve the SNR effectively, without the dependence on the periodicity of the signal and stable triggering.

Oscilloscopes

DSO/MSO

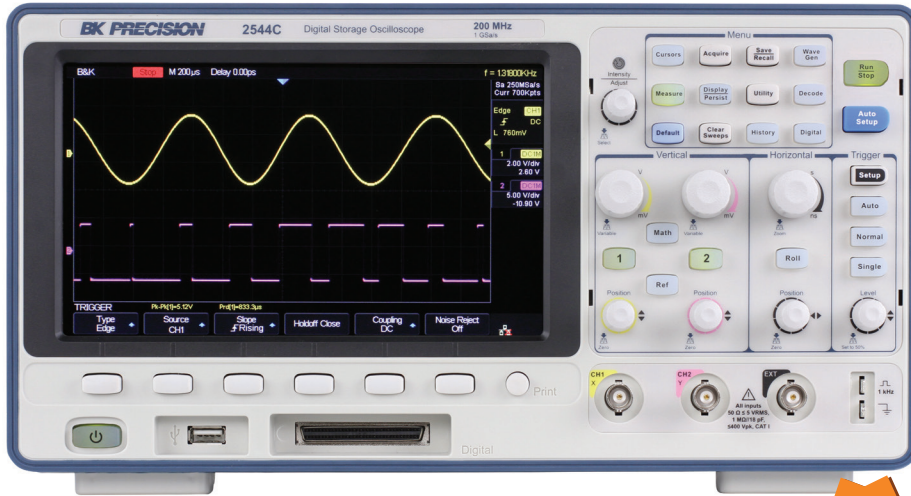

2540C Series Digital Storage and Mixed Signal Oscilloscopes

The B&K Precision 2540C Series dual channel digital storage oscilloscopes deliver performance and value, all in one portable solution. Maximize productivity using extensive features such as digital filtering, waveform recorder, pass/fail limit testing, and automatic measurements. These oscilloscopes offer powerful tools in a small affordable package with bandwidth up to 200 MHz, 1 GSa/s sample rate, and deep memory up to 14 Mpts. All models come standard with a built-in 25 MHz function/arbitrary waveform generator.

DSO Model	2540C	2542C	2544C
MSO Model	2540C-MSO	2542C-MSO	2544C-MSO
Bandwidth	70 MHz	100 MHz	200 MHz
Channels	2	2	2
Sample rate	1 GSa/s		
Max record length	14 Mpts		
Waveform update rate	60,000 wfms/s		
PC connectivity	Standard LAN (supports SCPI) and USB device port (USBTMC compliant)		
Available Upgrades			
16-channel digital logic probe*		✓	
Logic analyzer*		✓	
Serial bus decode and analysis package**		✓	
25 MHz function/arbitrary waveform generator	Standard		

*Standard on MSO model. **Supporting I2C, SPI, UART, RS232, CAN, and LIN Protocols.



Features & Benefits

- Bandwidth up to 200 MHz
- Deep waveform memory up to 14 Mpts
- 25 MHz built-in arbitrary waveform generator (AWG)
- 37 automatic measurements
- FFT plus three additional math functions
- Built-in context sensitive help system
- For educators - ability to disable the Auto set button
- PC software that lets you remotely control the oscilloscope and capture, save, and analyze waveform data
- Front panel USB port for convenient storing and recalling of waveform data, setups, and screenshots on a USB flash drive
- LAN interface enables users to capture screenshots from any standard web browser
- Seamlessly load waveforms from the oscilloscope into the WaveXpress waveform editing software

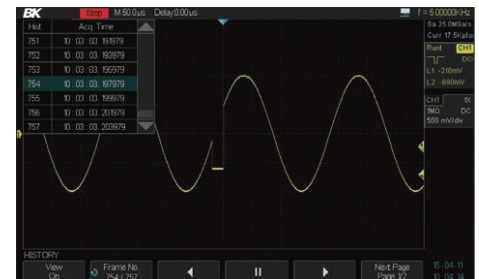

History and Segmented Acquisition Mode

Use the instrument's History and Sequence function to record and play back waveforms to find anomalies and quickly locate the source of the problem via cursor or measurement parameters.

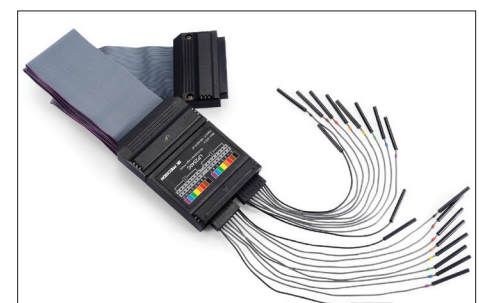

16-channel logic probe and logic analyzer function included with MSO models.

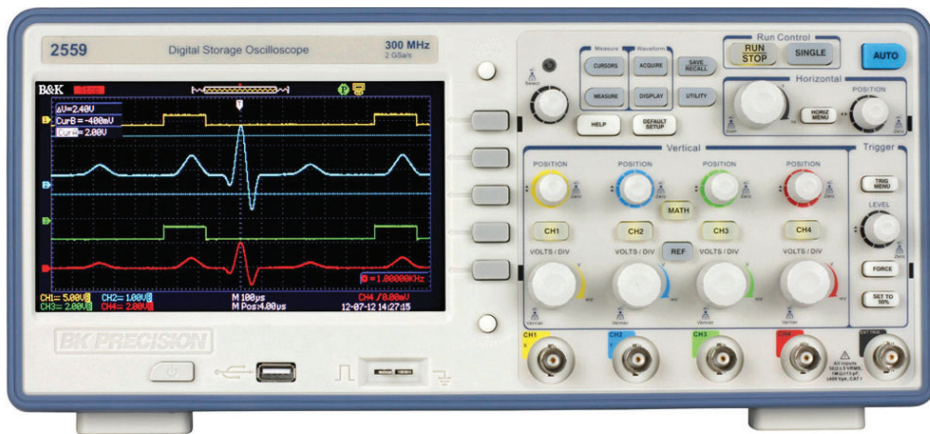

2550 Series Digital Storage Oscilloscopes

The 2550 Series Digital Storage Oscilloscopes provide high performance and value in 2-channel and 4-channel configurations. With bandwidths from 70 MHz to 300 MHz and 2 GSa/s sample rates, these oscilloscopes offer 24 kpts/Ch waveform memory, 32 automatic measurements, advanced triggering capabilities, math function, PC connectivity via LAN and USB. The 2550 is engineered for best visibility. The 7" TFT display offers a significantly larger viewing area than typical economy oscilloscopes (5.7").

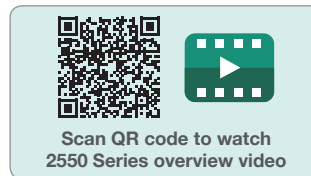

Specifications	2552	2553	2554	2555	2556	2557	2558	2559
Bandwidth	70 MHz		100 MHz		200 MHz		300 MHz	
Included probes	PR150 (150 MHz)				PR250 (250 MHz)		PR500 (500 MHz)	
Real time sample rate	2 GSa/s (interleaved), 1 GSa/s (per channel)							
Channels	2	4	2	4	2	4	2	4
Display	7" widescreen Color LCD							
Memory depth	24 kpts max. (interleaved, single CH operation), 12 kpts (each channel)							
I/O Interface	USB host port, USB device port, LAN							
Vertical resolution	8 bits							
Vertical sensitivity	2 mV – 5 V/div							
Weight	4.3 kg							
Dimensions (W x H x D)	336 x 118 x 152 mm							

Features & Benefits

- Bandwidth up to 300 MHz
- 2 GSa/s sample rate
- 4-Channel acquisition (on select models)
- Large 7" widescreen color display
- FFT including four additional math functions: Add, Subtract, Multiply, and Divide
- 32 automatic measurements
- USB host port for remote PC control
- Front panel USB device port for saving and recalling waveform setups, data, and screenshots on a USB flash drive
- 50 Ω input coupling
- PC control through EasyScope software
- Advance tools include digital filters with adjustable limits, pass/fail testing and waveform recorder mode
- Multi language user interface and context sensitive help
- Seamlessly load waveforms from the oscilloscope to WaveXpress waveform editing software and send them to arbitrary waveform generators

High bandwidth passive oscilloscope probes



PR150B/250B/500B

Avoid limiting the bandwidth of your measurement system. All 2550 series models come standard with high bandwidth, slimline passive probes (one per channel) to help you get the most out of your scope

Features

- Snap-locking sprung hook
- Easily replaceable tip
- Large accessory set
- Meets IEC 61010-031 CATII
- RoHS compliant

Oscilloscopes

Handheld



Scan QR code to watch 2510 Series overview video

Safety rated high bandwidth oscilloscope probes included



Probe Model PR250SA for 2515/2516

2510 Series Handheld Digital Storage Oscilloscopes

The 2510 Series handheld digital storage oscilloscopes provide floating measurement and recorder capabilities with a built-in digital multimeter (DMM), all in one portable and lightweight package. These versatile 60 MHz and 100 MHz bandwidth scopes offer 1 GSa/s sample rates, 2 Mpts waveform memory, 32 automatic measurements, and multiple recording functions to capture transient or long-term signal behavior.

Built-in Digital Multimeter

Applications

The 2510 Series handheld oscilloscopes are ideal for industrial applications, power systems, electronics design, and field test and service.

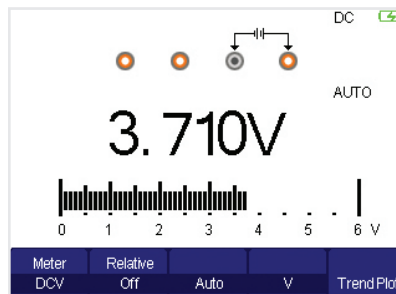

Speed up troubleshooting with the built-in 6000-count multimeter. Measurement functions include AC/DC voltage and current, resistance, capacitance, diode, and continuity test.

Features & Benefits

- 60 MHz (2511/2515) and 100 MHz (2512/2516) bandwidth
- 1 GSa/s sample rate
- Deep waveform memory up to 2 Mpts
- Built-in 6000-count DMM with dedicated terminals for current measurement
- Scope and meter trend plot functions for data logging
- Bright 5.7" color display
- Compact and lightweight – 1.54 kg
- FFT including four additional math functions: Add, Subtract, Multiply, and Divide
- 32 automatic measurements
- USB host port for saving and recalling waveform setups, data, and screenshots on a USB flash drive
- Software provided for remote PC control
- Multi-language user interface
- Up to four hours of continuous battery operation
- Advanced tools include digital filters with adjustable limits, scope and waveform recorder mode. The scope recorder function offers users 7 Mpts record length on a single channel or 3.5 Mpts on dual channels.

Bandwidth	Channels	CAT rating	Typical applications	Model
60 MHz	2 non-isolated	300 V CAT II	General electronics	2511
100 MHz				2512
60 MHz	2 fully isolated	1,000 V CAT II, 600 V CAT III	Power electronics and industrial	2515
100 MHz				2516

Oscilloscopes

Economy & Analog

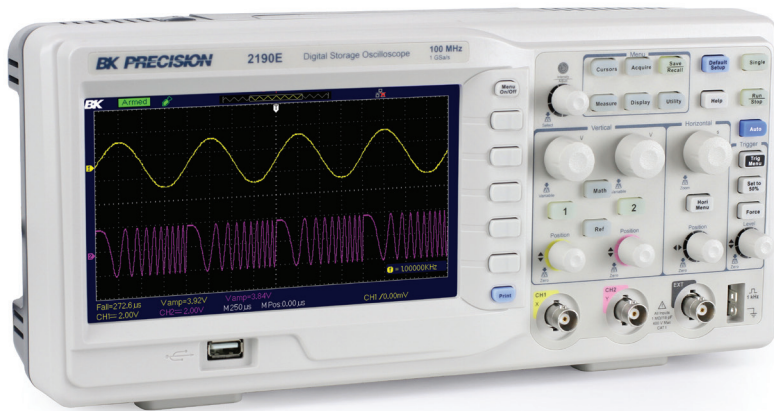

Features & Benefits

- 100 MHz bandwidth, 1 GSa/s sample rate
- Large, 7" widescreen color display offers a significantly larger viewing area than typical economy oscilloscopes (5.7")
- 32 automatic measurements
- FFT plus four additional math functions
- Versatile triggering capabilities including pulse width, line-selectable video, slope, and alternating trigger
- Advanced tools include digital filter with adjustable limits, pass/fail testing, and waveform recorder mode
- 12 different language user interfaces and context sensitive help
- Special EDU mode allows educators to disable Auto set button, Measure menu, and Cursors menu
- PC software that lets you remotely control the digital storage oscilloscope and capture, save, and analyze waveform data
- Front panel USB host port for saving and recalling waveform setups, data, and screen shots from the oscilloscope onto a USB flash drive
- LAN and USBTMC compliant USB device port supporting SCPI commands for remote PC control

2190E 100 MHz, 1 GSa/s, 2-Ch Digital Storage Oscilloscope

The 2190E oscilloscope combines performance and value all in one portable solution. With a large, high-resolution display, standard LAN and USBTMC-compatible USB interface, advanced triggering capabilities, and extensive features such as digital filtering, waveform recorder and 32 automatic measurements, this oscilloscope offers powerful tools in a small affordable package.

Powerful measurement functions

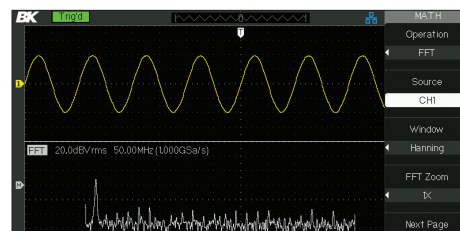

Display and measure the input signal's frequency spectrum. Select one of the 4 FFT windows: Rectangular, Hanning, Hamming and Blackman. Use cursors to measure the spectral component's magnitude and frequency.

Specifications	2190E
Bandwidth	100 MHz
Sample Rate	1 GSa/s
Memory	40 kpts
Display	7" widescreen color LCD with 800 x 480 resolution
I/O	Front panel USB host port supporting USB flash drives and optional USB-to-GPIB adapter, LAN, RS232 and USB (USBTMC-compliant) device port for connection to PC, Pass/Fail output

Analog Oscilloscopes

B&K Precision offers a wide selection of analog oscilloscopes. From entry-level to high performance, these oscilloscopes provide many features at a low cost.

B&K Precision's 212x Series are dual trace oscilloscopes that offer high performance at a low price. Most competitors' entry level oscilloscopes have a 20 MHz bandwidth, while B&K Precision's 212x Series have a bandwidth of 30-60 MHz.



Common Features & Benefits

- Dual or single trace operation
- 5 mV/div sensitivity
- Calibrated 23-step time base with X10 magnifier
- Video sync trigger
- Alternate/chop sweep
- Sum and difference capability

Specifications	2120C	2121C	2125C	2160C
Bandwidth	30 MHz	30 MHz	30 MHz	60 MHz
Sweep Time		0.1 μ s/div - 2 s/div		20 ns/div - 5 s/div
Component Tester	-	-	✓	✓
Counter	-	✓	-	-

COMPONENT TESTERS

Troubleshoot with confidence



B&K Precision offers a wide range of component testers that can measure and identify values of capacitors, resistors, inductors, diodes, ICs, and transistors. Major applications are component sorting or circuit troubleshooting.

LCR Meters are versatile instruments as they can measure most common passive components used in electronic circuitry. Capacitance meters on the other hand are dedicated to testing capacitors only, and typically offer a wider capacitance measurement range. Our transistor testers and ESR meters can be invaluable tools when testing and troubleshooting components “in-circuit”, while logic probes are always used in-circuit. IC Testers are used to identify and test certain analog and digital ICs.

Category	Description	Max range	Basic accuracy	Model	Page
LCR, bench	500 kHz LCR Meter	150 kH / 150 mF / 100 MΩ	0.05%	894	40
	1 MHz LCR Meter	150 kH / 150 mF / 100 MΩ	0.05%	895	40
	300 kHz LCR Meter	150 kH / 80 mF / 20 MΩ	0.1%	891	41
	200 kHz LCR Meter	31.83 kH / 15.91 mF / 20 MΩ	0.1%	889B	41
LCR, handheld	LCR Meter	200 H / 20 mF / 20 MΩ	1%	875B	42
	1 kHz LCR Meter	1 kH / 20 mF / 10 MΩ	0.5%	878B	42
	10 kHz LCR Meter	1 kH / 20 mF / 10 MΩ	0.5%	879B	42
	10 kHz LCR Meter	31.83 kH / 15.91 mF / 20 MΩ	0.2%	885	42
	100 kHz LCR Meter	1 kH / 20 mF / 10 MΩ	0.1%	880	42
	100 kHz LCR Meter	31.83 kH / 15.91 mF / 20 MΩ	0.2%	886	42
Capacitance	Compact Capacitance Meter	20 mF	0.5%	810C	43
	Dual Display Capacitance Meter	50 mF	0.5%	890C	43
	Dual Display Capacitance Meter	200 mF	0.5%	830C	43
Component tester	Component Tester	20 mF/ 20 MΩ	0.5%	815	43
IC	Linear IC Tester	---	---	570A	43
	Digital IC Tester	---	---	575A	43
ESR	In-Circuit ESR Tester	2200 μF	---	881	43
Logic probes	Digital Logic Probe	20 MHz	---	DP 21	43
	Digital Logic Probe	50 MHz	---	DP 52	43
	Logic Pulser Probe	400 Hz	---	DP 31A	43
DC resistance meter	DC resistance meter	20 kΩ	0.05%	2840	44
	DC resistance meter	100 MΩ	0.01%	2841	44

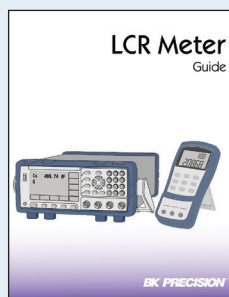

LCR Meter Guide

Introduction to the benefits of LCR meters and the theory behind the measurements, plus related terms and example applications.

For more guides and applications, visit: bkprecision.com/product-applications

Component Testers

Bench LCR

894 & 895 Performance LCR Meters

The 894 and 895 are high accuracy and high precision bench LCR meters capable of measuring inductance, capacitance, and resistance with a basic accuracy of 0.05% over a frequency of up to 1 MHz. These meters feature a vivid 4.3-inch TFT LCD with five convenient display modes, auto level control (ALC), cable length compensation (1/2/4 m), and bin sorting comparator. For accurate measurements, these performance LCR meters provide Open, Short, and Load corrections.

USB host port

Connect your USB flash drive to conveniently save data logs, settings, and screenshots.

Intuitive user interface

Easily change test parameters using the menu-driven front panel keypad.

Variable test signals

The instrument provides settable voltage levels from 5 mVrms to 2 Vrms to evaluate your DUT.



4.3" TFT color display

Pass/Fail LED indicators

Model 895



Cs :
46.6180µF

D :
0.47232

Vm : 50.00mV Im : 13.24mA

Zoom display mode

With a touch of a button, users can enlarge the display for easy viewing from a distance. The voltage and current across the DUT are also monitored in this display mode.

< BIN No. DISP >

FUNC : R-X	RANGE : AUTO	ON
FREQ : 1.000kHz	BIAS : 0.00 mV	OFF
LEVEL : 1.000 V	SPEED : SLOW	
	COMP : ON	

BIN OUT

R : 7.08130 Ω	X : -1.62169kΩ
CAL : OFF	

BIN comparator

Use the BIN comparator function to sort components in up to 10 bin locations.

Model	894	895
Measurement parameters	L, C, R, G, X, Z, Y, B, G, θ, Q, D, DCR	
Basic accuracy	0.05%	
DCR measurement range	0.01 Ω - 100 MΩ	
Test signal	Frequency range	20 Hz - 500 kHz 20 Hz - 1 MHz
	Frequency accuracy	0.01%
	AC level range	5 mVrms - 2 Vrms / 50 µArms - 20 mArms (adjustable)
	DC bias	0 V - +5V / 0 mA - +25 mA
	Output impedance	10 Ω, 30 Ω, 50 Ω, or 100 Ω
Selectable measurement speeds	13 ms (Fast), 90 ms (Med), 370 ms (Slow)	
Auto level control (ALC)	√	
Cable length compensation	√	
Handler interface	√	
Remote interface	RS232, USB (USBTMC), LAN, and GPIB (895 Only)	
Dimensions	369 x 108 x 408 mm	
Weight	5 kg	

< LIST SWEEP DISP >

MODE : SEQ	No.	FREQ[Hz]	Cs[F]	D []	CMP	MEAS DISPLAY
	001	20.0000	102.797n	0.00162	L	BIN NO.
	002	5.01990k	101.775n	0.00773	P	BIN COUNT
	003	10.0198k	101.408n	0.00973	P	LIST SWEEP
	004	15.0197k	101.149n	0.01098	P	
	005	20.0196k	100.946n	0.01183	P	
	006	25.0195k	100.780n	0.01255	P	
	007	30.0194k	100.637n	0.01315	P	
	*008	35.0193k	100.511n	0.01371	P	
	009	40.0192k	100.400n	0.01423	P	
	010	45.0191k	100.301n	0.01466	P	

List sweep

Use the built-in sweep function to conveniently display, analyze and store primary and secondary parameters of a component at up to 201 frequencies.

< LAN SETUP >

LAN Status : Working Properly	SYSTEM SETUP
HOST NAME : 89x	LAN SETUP
DHCP : OFF	
AUTO IP : OFF	
IP ADDR : 10. 0. 1. 55	DEFAULT SETTINGS
SUBNET MASK : 255.255.254. 0	SYSTEM RESET
GATEWAY : 10. 0. 1.254	
DNS SERVER1 : 10. 0. 1.254	
DNS SERVER2 : 10. 0. 1.254	

Remote PC control

Integrate your LCR meter into an automated test system and control it from a PC using SCPI commands via the RS232, USB, LAN, or GPIB interface.

Component Testers

Bench LCR



NEW

891 300 kHz Bench LCR Meter

The 891 is a compact, precise, and versatile LCR meter capable of measuring inductors, capacitors, and resistors at DC or from 20 Hz to 300 kHz, at both low and high impedance ranges. A large color display with all important parameters and measurements visible on one screen makes this meter easy to operate. A standard USB, GPIB and LAN interface enhances your productivity. The outstanding performance of the 891 makes it an invaluable tool in production, quality control and R&D.

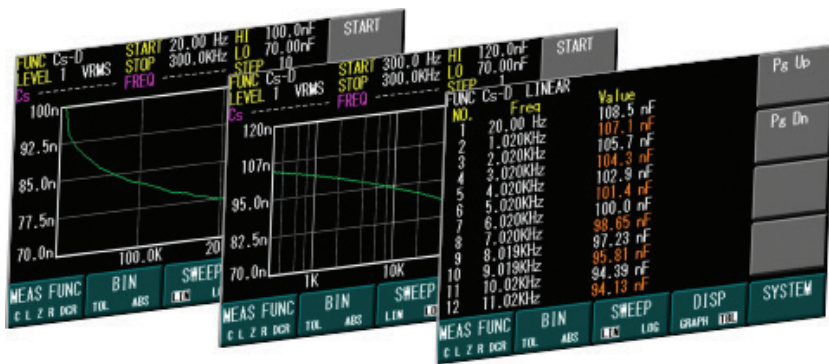

Linear and logarithmic sweep function

Characterize components up to 300 kHz using a 300-point linear or logarithmic sweep. Measured values for each frequency point can be read directly on the display. Sweep results can be displayed on a graph or table and then saved to a USB flash drive or read out through the remote interface.

Features (model 891)

- Measurement parameters: L, C, R, Z, G, B, Y, D, Q, θ , DCR
- 0.05% best impedance accuracy
- Fully adjustable test frequency from 20 Hz to 300 kHz with 4-digit resolution
- Adjustable measurement speed for fast readout or better accuracy
- Save/recall up to 100 setups (10 internal) including 1000 measurements and screenshots
- Standard USB (Virtual COM), GPIB, and LAN interface for remote control
- BIN sorting function

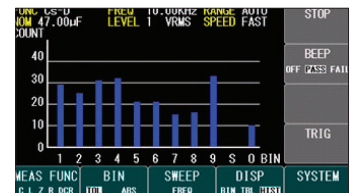

Quickly sort components with 9 primary BINS, 1 secondary BIN, and 1 out BIN



889B 200 kHz Bench LCR Meter

Features & Benefits

- Measurement parameters: ACV, DCV, Z, L, C, DCR, ESR, D, Q, and \emptyset
- Diode and continuity measurements
- Measures DCV to 600 V and ACV to 600 Vrms at 40 Hz to 1 kHz
- Virtual COM USB interface

Specifications	Test signal		Inductance measurable range	Capacitance measurable range	Resistance measurable range	Weight	Dimensions (W x H x D)
	Frequency	Level					
891	20 Hz - 300 kHz	0.5 Vrms & 1 Vrms selectable	0.05 uH - 150 kH	0.06 pF - 80 mF	0.1 Ω - 20 M Ω	3.4 kg	258 x 113 x 381 mm
889B	100 Hz, 120 Hz, 1 kHz, 10 kHz, 100 kHz, 200 kHz	1 Vrms, 0.25 Vrms, 50 mVrms, 1 VDC (DCR only)	0.079 uH - 31.83 kH	0.079 pF - 15.91 mF	0.1 Ω - 20 M Ω	4.5 kg	220 x 300 x 150 mm

Component Testers

Handheld LCR

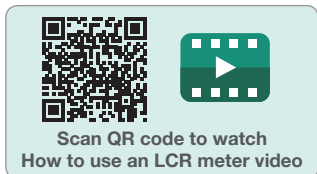

878B, 879B and 880 40,000-count Dual Display LCR Meters

The 878B, 879B, and 880 40,000-count handheld LCR meters measure inductance, capacitance, and resistance quickly and precisely. The 879B and 880 also measures impedance, θ , DCR, and ESR.

Additionally, the 880 offers capabilities typically only found in bench LCR meters such as a 4-terminal configuration, basic measurement accuracy up to 0.1%, test frequencies up to 100 kHz, selectable test signal levels, and measurement rate.

Fast auto ranging and quick measurement configuration such as measurement parameter and test frequency selection make these meters very simple to operate.

Applications

- Passive components trouble shooting
- Quality control (component sorting)

Features & Benefits

- 40,000 counts resolution on primary and 10,000 counts resolution on secondary display
- L, C, R, and Z (879B & 880 only) primary measurements
- Automatic calculation of secondary parameters D, Q, θ , ESR (θ /ESR for 879B & 880 only), and DCR (880 only)
- Accuracy up to 0.1% and selectable test frequencies up to 100 kHz (880 only)
- Fast auto range design for rapid, easy component measurements
- Auto detect mode for automatic component type identification and measurement type selection (880 only)
- Backlit display (879B & 880 only)
- Data Hold and Min/Max/Average recording
- USB (Virtual COM) interface
- SCPI compliant commands for remote communication

Models 885 & 886 are 10,000-count handheld meters equipped with 4-wire terminal connections to facilitate more accurate measurements.

Features & Benefits

- Measurement parameters: Z, L, C, DCR, ESR, D, Q, and θ
- Test conditions: 100 Hz, 120 Hz, 1 kHz, 10 kHz, 100 kHz (model 886), 1 Vrms, 0.25 Vrms, 0.05 Vrms
- 0.2% basic accuracy
- Dual LCD display
- SMD surface mount tweezer probe included

Model 875B is a manual range, hand-held 20,000 count LCR meter that is reliable and easy to use.

Features & Benefits

- Measures D (dissipation factor)
- Zero adjustment knob

Specifications	Test signal		Inductance measurable range	Capacitance measurable range	Resistance measurable range	Weight	Dimensions (W x H x D)
	Frequency	Level					
875B	120 Hz, 1 kHz	Approximately 0.5 Vrms	20 μ H - 200 H	20 pF - 20 mF	0.2 Ω - 20 M Ω	400 g	88 x 177 x 40 mm
878B	120 Hz, 1 kHz	Approximately 0.6 Vrms	40 μ H - 1000 H	40 pF - 20 mF	0.04 Ω - 10 M Ω		
879B	100 Hz, 120 Hz, 1 kHz, 10 kHz	Approximately 0.6 Vrms	4 μ H - 1000 H	4 pF - 20 mF	0.04 Ω - 10 M Ω	330 g	90 x 190 x 41 mm
880	100 Hz, 120 Hz, 1 kHz, 10 kHz, 100 kHz	0.3 Vrms, 0.6 Vrms, 1 Vrms, 1 VDC	0.4 μ H - 1000 H	0.4 pF - 20 mF	0.04 Ω - 10 M Ω		
885	100 Hz, 120 Hz, 1 kHz, 10 kHz	1 Vrms, 0.25 Vrms, 50 mVrms, 1 VDC (DCR only)	1.592 μ H - 31.83 kH	0.795 pF - 15.92 mF	0.1 Ω - 20 M Ω	470 g	86 x 175 x 48 mm
886	100 Hz, 120 Hz, 1 kHz, 10 kHz, 100 kHz		0.159 μ H - 31.83 kH	0.795 pF - 15.92 mF			

Component Testers

Handheld Capacitance, IC, ESR, Logic

830C & 890C Dual Display Handheld Capacitance Meters



Model 890C

The 830C and 890C are 11,000-count handheld capacitance meters that measure capacitance up to 200 mF and 50 mF respectively. Straightforward to operate, these meters make measurements quickly and simplify the capacitance sorting process. Unlike other handheld instruments such as LCR meters that make measurements using an AC signal with a specific test frequency, these meters measure capacitance by applying a constant current that briefly charges, then discharges the connected capacitor.

Features & Benefits

- 0.5% basic accuracy
- Measure capacitance up to 200 mF (50 mF for 890C) right LCD backlight
- Fast auto ranging design for rapid, easy component measurements
- USB (Virtual COM) interface
- SCPI compliant commands for remote communication
- Software for data logging and front panel emulation available as free download

The **810C** is a compact manual ranging capacitance meter, designed for accurate, cost-effective measurements of capacitive components. It features fused direct-plug-in test sockets, test lead jacks, and a zero adjustment knob to "zero" test lead capacitance.

Specifications	Special Features	Test Level	Measurable Range	Weight	Dimensions (W x H x D)
810C	Manual range dial	<3.5 V	20 pF - 20 mF	200 g	70 x 151 x 38 mm
890C	Sorting function, tolerance function	<3 V	100 pF - 50 mF	350 g	190 x 90 x 41 mm
830C	Sorting function, tolerance function	<3 V	100 pF - 200 mF	350 g	190 x 90 x 41 mm

881 In-Circuit ESR & DCR Capacitor Tester



Model 881

The 881 is a portable In-Circuit ESR Meter that measures the equivalent series resistance of electrolytic capacitors in or out of circuit and can also be used to measure low value non-inductive resistors. In-circuit measurements are dependent on the circuit design of the capacitor being measured.

Features & Benefits

- Measures ESR with a range of 0.1 to 30 Ω
- Measures DCR with a range of 0.1 to 30 Ω
- 15 mVp-p output test voltage (will not turn on any solid-state devices)
- Includes a one-handed tweezer test probe

570A & 575A IC Testers

The 570A interfaces with analog ICs and the 575A with digital ICs. Both versions emulate passive circuitry around the IC under test to ensure that a comprehensive test takes place. The units automatically sense the functionality of the device to be tested and display a list of possible equivalents for replacement.

Features & Benefits

- Auto identification mode
- Conditional/unconditional loop testing mode
- Displays diagnostic information down to individual component pins

815 Component Tester

The 815 is a handy meter measuring capacitance up to 20 mF and resistance up to 20 M Ω and can also test transistors, diodes, SCRs, LEDs, and batteries.

Features & Benefits

- Transistor leakage test
- Diode and SCR test
- LED test
- Battery test

Logic Probes

For use with TTL and CMOS circuits and ICs



Model DP 21

Model	Description
DP 21	20 MHz Digital Logic Probe
DP 52	50 MHz Digital Pulser Probe
DP 31A	400 Hz Digital Pulser Probe

Component Testers

DC Resistance



Touch screen to zoom or enter values

2840 Series DC Resistance Meters

The 2840 Series DC resistance meters feature high accuracy and resolution. Both meters are ideally suited for measuring contact resistance of relays, switches, interconnects, PCB traces, bonds, and cables. The 2841 adds extended range, accuracy and temperature measurement for evaluating coils, motor windings, transformers, actuators and conductive materials. The 2840 is economically priced to meet the need of applications where extended range and temperature correction are not required.

Large color touch screen with user-friendly interface provides intuitive operation. Using the software keypad of the touch screen, users can easily set various functions and values.

Handler interface with high-speed measurement capabilities enable the 2840 Series to be used for evaluating and bin sorting of large component quantities.

Applications

Both meters are ideally suited for measuring contact resistance of relays, switches, interconnects, PCB traces, bonds, and cables. The 2841 adds extended range, accuracy and temperature measurement for evaluating coils, motor windings, transformers, actuators and conductive materials.



*2841 only

Model	2840	2841
Measurement range	1 $\mu\Omega$ - 20 k Ω	0.1 $\mu\Omega$ - 110 M Ω
Basic accuracy	0.05%	0.01%
Measurement resolution	1 $\mu\Omega$	0.1 $\mu\Omega$
Displayed measurements	1	1 or 2
Measurement functions*	R and LPR	R, R-T, T, LPR, LPR-T
Ranges	4 + Auto	11 + Auto
Temperature measurements (TC and Δt)	--	✓
Bins	3	10
Remote interface	RS232, USB (USBTMC)	LAN, RS232, USB (USBTMC)

*R – Resistance, LPR – Low Power Resistance, T - Temperature

Features

- 4.3-inch color touch screen
- One touch full screen measurement view
- Simultaneous display of two different measurements (2841 only)
- Four-terminal Kelvin type test leads included
- Temperature measurement with correction (2841 only)
- Low power test mode to protect DUT
- Manual or Auto ranging
- User selectable speed options
- Maximum sample rate: 50 samples per second
- Offset voltage compensation (OVC)
- Zero correction (0 ADJ)
- $\Delta\%$ mode for quickly determining the percent difference between components
- Bin-sorting with Statistical functions
- Comparator and pass/fail alarming beeper function
- Memory for 30 groups of parameters
- Screen capture to USB drive
- Automatically update operation software through USB
- Power line filtering to eliminate the influence of the power noise on the instrument
- Trigger delay
- Handler interface
- Standard RS232 and USBTMC interface
- LAN interface (2841 only)

Battery Test Solutions

B&K Precision offers a wide array of internal resistance/impedance based battery test solutions including handheld and benchtop units for field environments, labs, quality control, and production use, as well as frequency response analyzers for complex AC impedance data analysis and charge/discharge systems.

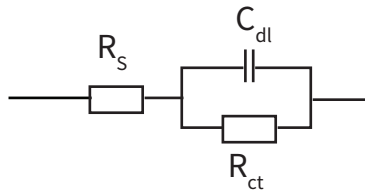

Model of simplified Randles cell

Battery charge/discharge solution with sequencing and data logging



Model	9200/9115 & 8600/SDL Series	600B & 601B	BA6010 & BA6011	FRA8000
Test method	Charge / Discharge Charge and discharge battery while logging results	DC Resistance Measure open and loaded battery voltage	AC Impedance Uses a 1 kHz fixed frequency AC signal to calculate battery impedance	EIS (electrochemical impedance spectroscopy) Stimulate the battery with a low-level sinusoidal AC current at a particular frequency and then measure both the stimulating AC current and the resultant AC voltage. Repeat for various frequencies.
Result	V/I plots with calculated amp-hours (Ah) or C-rate	Calculates internal resistance and displays remaining capacity of lead-acid battery in %	Real-time display of voltage, impedance, phase angle and capacitance	Real-time display of voltage, current and impedance. Generates Nyquist and Bode plots to identify specific battery model elements.
Advantages	Measures actual capacity of a battery directly	Quick, easy and repeatable measurement	Fast measurement speed. Ability to measure battery capacitance.	Provides large amount of data and detailed information about individual battery model elements
Disadvantages	Time consuming	Ignores battery capacitance, resistive battery model elements lumped together	Individual battery model elements seen as one impedance value	Requires complex data analysis

600B & 601B Handheld Battery Capacity Analyzers

The 600B and 601B Handheld Battery Capacity Analyzers address the need to test and maintain sealed lead acid (SLA) batteries used in backup power UPS, emergency lighting, fire alarms, security systems, and many other electrical systems. By quickly characterizing a battery's response to a load resistance, these meters display the remaining battery capacity as an indicator of the battery's health.



Model	600B	601B
Supported SLA battery voltages	12 V	6 V & 12 V
Ah range	7, 12, 24, 42, 65, & 100	5 - 100 in 1 Ah steps
No load (open circuit) voltage accuracy	±2 counts	±(0.2% + 1 count)
Internal resistance	--	✓
Load voltage	--	✓
Dimensions (W x H x D)	74 x 265.1 x 54 mm	74 x 265.1 x 58 mm
Weight	1.2 kg	

Battery Test

Battery Analyzers



BA6010 Series Battery Analyzers

The BA6010 Series Battery Analyzers use a 1 kHz AC constant current source to measure the battery's impedance expressed by 11 different measurement functions. With a basic voltage and impedance accuracy of 0.1% and micro-ohm resolution, these instruments are well-suited for analyzing a wide range of battery types and configurations in the lab, quality control and manufacturing environments.

Features & Benefits

- 4.3 inch color LCD display
- Graphing display of voltage and resistance with on-screen measurement tools
- 4-wire test fixture with monitoring for Hi drive open, Low drive open, and both open
- Compare and sort using 10 bins with statistical evaluations
- Δ% mode for quickly determining the percent difference between batteries
- Pass/Fail indicator with audible tone
- Fast test speed up to 50 measurements per second
- Handler interface
- Internal and external file storage

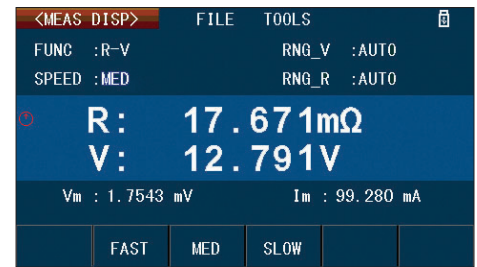

Dual Display



TLKB1 - Kelvin test lead

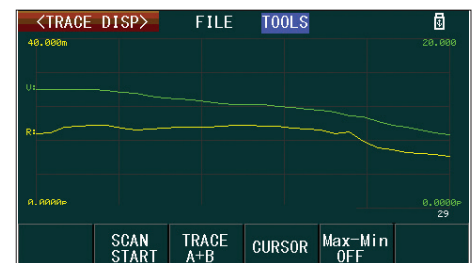

Data logging

Model	Input voltage	Input range	Measurement functions (displayed)	Test signal	Basic accuracy impedance	Impedance resolution	Voltage resolution	Remote interface
BA6010	100 uV to 60 V	6 V / 60 V	R, R-V, V, R-Q, L-Q, L-R, R-X, C-D, Z-Q, Z-R and R-C	Sine wave (1 kHz ±0.2 Hz)	0.1%	1 μΩ	100 μV	RS232, USB
BA6011	100 uV to 300 V	30 V / 300 V						

Battery Test

Frequency Response Analyzer



FRA8000 Frequency Response Analyzer

In combination with a DC electronic load, the FRA8000 can be used to perform electrochemical impedance spectroscopy (EIS) measurements for analysis of:

- Primary and secondary batteries
- Super capacitors and fuel cells
- Corrosion and surface treatments

Features & Benefits

- Compatible with any DC load that has a programmable analog input to measure high-voltage or high-power battery packs
- High selectivity two stage receiver architecture for high noise immunity
- Simultaneous V/I measurement to ensure exact impedance and phase information
- Auto gain control and flexible ranges for measuring small signals in noisy environments with micro-ohm sensitivity
- Adjustable sampling interval
- USB, GPIB, and LAN connectivity
- DDS sinewave generation yielding frequency errors less than 0.02 Hz
- Signal overload protection

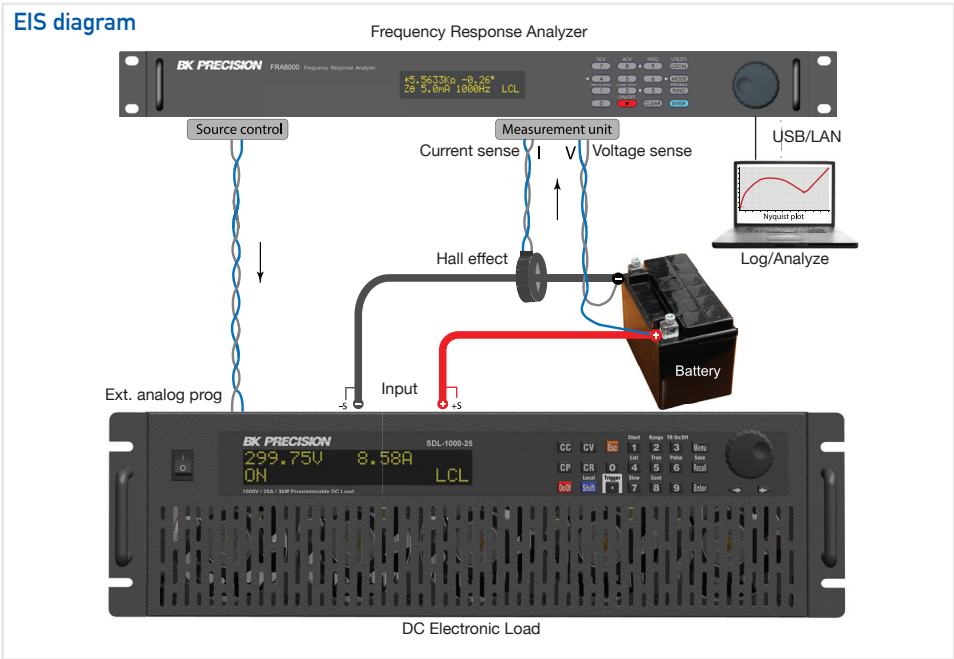

The FRA stimulates the battery via the DC load's analog programming input with a small sinewave signal at a specific frequency, measures the battery's voltage and current response and calculates the complex impedance. The FRA measurement unit is capable of extracting very small signals from noisy waveforms and compare their gain and phase. The stimulus signal is swept from frequencies as low as 0.1 Hz to the desired maximum frequency.

AC source	Programmable frequency range	0.1 Hz - 20 kHz
	Frequency resolution	0.01 Hz
	Amplitude	Up to 20% of DC bias setting or 1 Vrms
	Amplitude resolution	5 mVpp
	Distortion	< 0.2%
DC bias source	Range	10 mV - 10 V
	Resolution	10 mV
	Accuracy	0.1% ± 50 mV
Analyzer/ measurement unit	Output impedance	50 Ω
	Range	Auto
	Sensitivity	1 μV
	Dynamic range	120 dB
	Sample Interval:	10 ms - 10 s
	Phase accuracy	1°
	Basic amplitude accuracy	+/-2% 0.1 Hz - 9.99 Hz, +/- 0.5% 10 Hz - 9999 Hz, +/-1% 10 kHz - 20 kHz

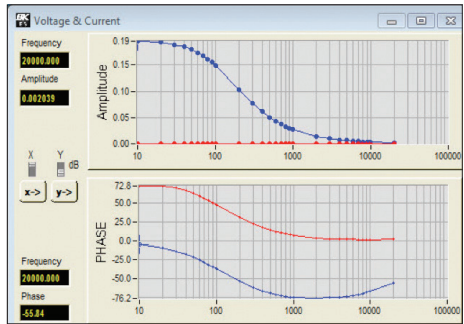

V/I plot

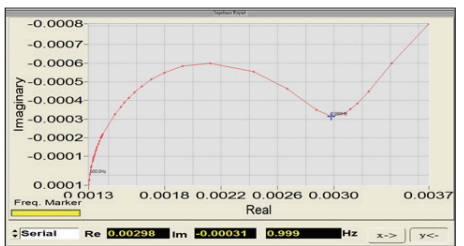

Nyquist diagram

Analysis Software Features

- Nyquist, Bode, and V/I graphs
- Real-time display of impedance measurements and operating conditions
- Frequency sweeps with adjustable amplitude in log/linear form
- Automatic or manual scaling and shifting of screen plots for optimum viewing
- Advanced marker functions
- User-friendly control panel with auto-gain, auto-sample, and logging capabilities

SIGNAL GENERATORS

Stimulus signals for design and test



Signal Generators

Selection Guide

Arbitrary/Function Generators

Type	Frequency range	Number of channels	Arbitrary			Modulation		Output range (into 50 Ω)	Interface	Special features	Model	Page
			Waveform length	Sample rate	Vertical resolution	AM / FM	Other					
Performance Arbitrary & Function Generator*	1 uHz-30 MHz	1	1 Mpts	200 MSa/s	14 bit	int/ext	FSK	10 mV-10 Vpp	USB	marker	4075B	51
	1 uHz-30 MHz	2	1 Mpts	200 MSa/s	14 bit	int/ext	FSK	10 mV-10 Vpp	USB	marker	4078B	51
	1 uHz-50 MHz	1	4 Mpts	200 MSa/s	14 bit	int/ext	FSK	10 mV-10 Vpp	USB, GPIB	marker, summing input	4076B	51
	1 uHz-50 MHz	2	4 Mpts	200 MSa/s	14 bit	int/ext	FSK	10 mV-10 Vpp	USB, GPIB		4079B	51
	1 uHz-80 MHz	1	16 Mpts	200 MSa/s	14 bit	int/ext	FSK	10 mV-10 Vpp	USB, GPIB		4077B	51
	1 uHz-80 MHz	2	16 Mpts	200 MSa/s	14 bit	int/ext	FSK	10 mV-10 Vpp	USB, GPIB		4080B	51
Basic Arbitrary & Function Generator**	1 uHz-10 MHz	2	16 kpts	150 MSa/s	14 bit	int/ext	ASK, FSK, PM, PSK, DSB-AM, PWM	2 mVpp-10 Vpp	USB, LAN, GPIB option	counter, color display	4053B	53
	0.01 Hz-20 MHz	1	1 kpts	50 MSa/s	12 bit	int/ext	-	10 mV-10 Vpp	USB	counter	4045B	53
	0.01 Hz-25 MHz	2	16 kpts	125 MSa/s	14 bit	int/ext	FSK, PM, PWM	10 mV-10 Vpp	USB	counter	4047B	53
	1 uHz-30 MHz	2	16 kpts	150 MSa/s	14 bit	int/ext	ASK, FSK, PM, PSK, DSB-AM, PWM	2 mVpp-10 Vpp	USB, GPIB option	counter, color display	4054B	53
	1 uHz-60 MHz	2	16 kpts	150 MSa/s	14 bit	int/ext					4055B	53
	1 uHz-80 MHz	2	16 kpts	500 MSa/s	14 bit	int/ext			USB, GPIB option	counter, color display	4063	52
	1 uHz-120 MHz	2	16 kpts	500 MSa/s	14 bit	int/ext					4064	52
1 uHz-160 MHz	2	16 kpts	500 MSa/s	14 bit	int/ext	4065					52	

Note: All generators produce basic function generator waveforms sine, square, triangle, TTL/CMOS and ramp/pulse and complex waveforms including noise, sin(x)/x, exponential and Gaussian
 * = True AWG capable of generating almost any waveform combined with full function generator functionality (two in one)
 ** = Primarily DDS function generators with basic Arb. capability in terms of memory space, vertical resolution, and maximum output frequency

Function Generators

Type	Frequency range	Waveforms		Modulation		Sweep lin/log	Burst	Output range (into 50 Ω)	Interface	Special features	Model	Page
		Basic *)	Other	AM/FM	Other							
Digital (DDS)	1 Hz-5 MHz	√	-	-	-	-	-	10 mV-10 Vpp	-	-	4005DDS	54
	0.1 Hz-7 MHz	√	-	-	-	√	-	10 mV-10 Vpp	-	-	4007B	54
	0.1 Hz-12 MHz	√	-	-	-	√	-	10 mV-10 Vpp	-	-	4013B	54
	0.01 Hz-12 MHz	√	-	int/ext	-	√	-	10 mV-10 Vpp	USB	counter	4014B	54
	0.01 Hz-20 MHz	√	-	int/ext	-	√	√	10 mV-10 Vpp	USB	counter	4040B	54
Analog	0.2 Hz-2 MHz	√	-	-	-	-	-	100 mV-10 Vpp	-	-	4010A	56
	0.5 Hz-4 MHz	√	-	-	-	√	-	100 mV-10 Vpp	-	-	4001A	56
	0.5 Hz-4 MHz	√	-	-	-	√	-	100 mV-10 Vpp	-	counter	4003A	56
	0.5 Hz-5 MHz	√	-	-	-	-	-	100 mV-10 Vpp	-	-	4011A	56
	0.5 Hz-5 MHz	√	-	-	-	√	-	100 mV-10 Vpp	-	-	4012A	56
	0.1 Hz-10 MHz	√	-	-	-	√	-	100 mV-10 Vpp	-	-	4017A	56
	0.2 Hz-20 MHz	√	-	int/ext	-	√	√	100 mV-10 Vpp	-	counter	4040A	56

Note: *) basic waveforms include sine, square, triangle, TTL/CMOS and ramp/pulse

Pulse Generators

Type	Frequency range	Transition time	Width	Delay	Number of outputs	Model	Page
Analog	0.1 Hz-10 MHz	12 ns	50 ns - 50 ms	0 - 2 μs	1	4030	56
Digital	0.1 Hz-50 MHz	6 ns - 100 ms	10 ns - 10 s	0 - 10 s	1	4033	55
	0.1 Hz-50 MHz	6 ns - 100 ms	10 ns - 10 s	0 - 10 s	2	4034	55

Other Signal Sources

Type	Frequency range	Waveforms		Modulation	Output range	Model	Page
		Sine	Square	AM			
Audio	20 Hz-150 kHz	√	√	-	0-1.2 Vpp	3001	56
Signal	0.1 Hz-10 MHz	√	√	-	0-4.5 Vpp (no load)(sine), 5 Vpp (no load)(square)	3003	56
	100 kHz-150 MHz	√	-	int/ext	100 mVrms max.	2005B	56

Signal Generators

WaveXpress Software



WaveXpress is a comprehensive stand-alone application with several transformation options, allowing users to easily create complex waveforms. Modify a waveform downloaded from a scope or construct a new waveform using powerful and intuitive editing tools. Quickly download them to your AWG and begin testing your circuits and systems moments later. The WaveXpress program can also be used for general-purpose waveform editing without requiring any instruments to be connected to the computer.

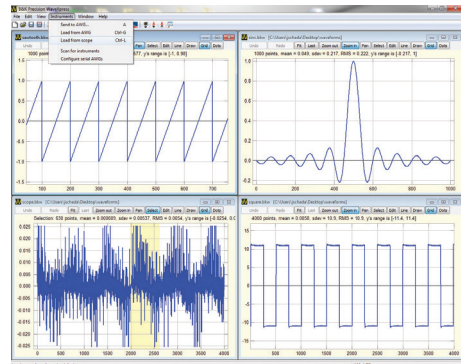
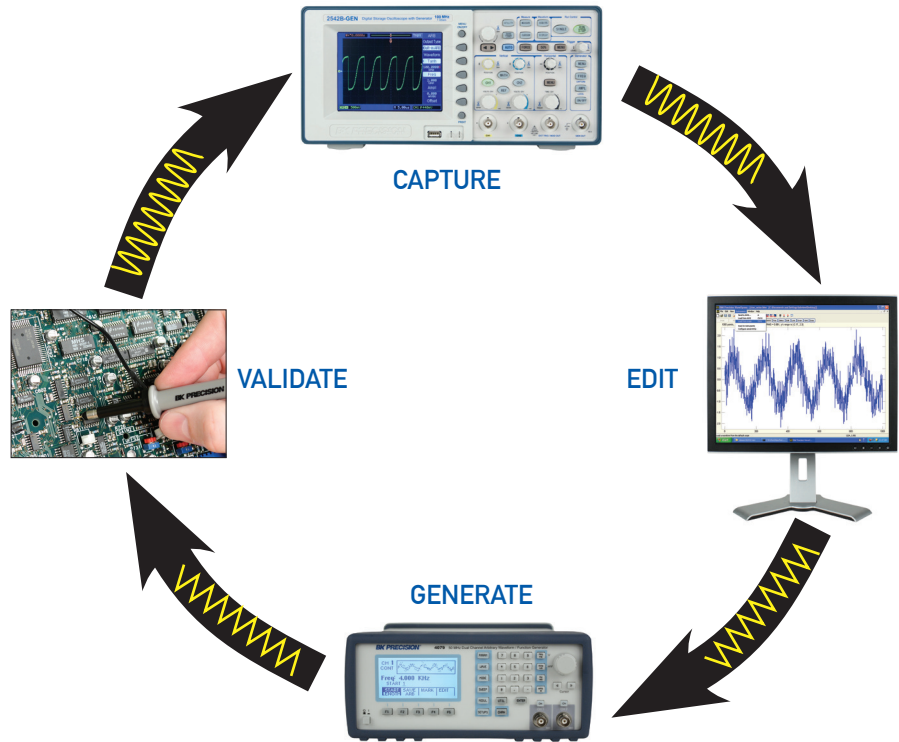

Waveform creation capabilities

Features & Benefits

- Import waveforms from B&K scopes, AWGs, or load them from CSV or text files
- Autoscan function automatically detects instruments connected via RS232, USB, or GPIB
- Generate waveforms from scratch with drawing and editing tools.
- Insert commonly used waveforms and different types of noise
- Numerous transformations for changing a waveform. User-defined transformations can be added in the python programming language
- Multi-language support: additional languages can be added by the user
- Fast zooming and panning with mouse
- Dialog settings are remembered for faster repetitive work
- Undo/redo functions allow quick experimentation

Waveforms	Filters	Noise	Transformations	Supported file formats	Supported interfaces
Sine Square Triangle Sawtooth Pulse Sinc Noise Exponential Rise/Decay	Savitzky-Golay smoothing Low-pass Band-pass High-pass Notch	Beta Chi Square Exponential F Gamma Laplace Lognormal Logistic Normal Rayleigh Uniform Weibull	Linear (ax + b) Gaussian noise Clip Resample Convert to DC (max, min, average, or RMS) Signum Absolute value Sort ordinates Reverse ordinates (mirror about vertical axis) Differentiate Integrate Make positive Normalize amplitude to unity Zero amplitude Negate (mirror about horizontal axis) CSV, ASCII, proprietary BKW file	CSV, ASCII, proprietary BKW file	RS232/USB/GPIB

Supported Instruments	
Oscilloscopes	2540C (-MSO) Series, 2550 Series, 2560 Series
AWGs	4045B, 4047B, 4075B - 4080B Series

Download Information:
www.bkprecision.com/WaveXpress

System requirements:
 Windows XP or later
 NI-VISA Run-Time Engine*

*Download from the NI website link below:
<http://joule.ni.com/nidu/cds/view/p/id/1606/lang/en>

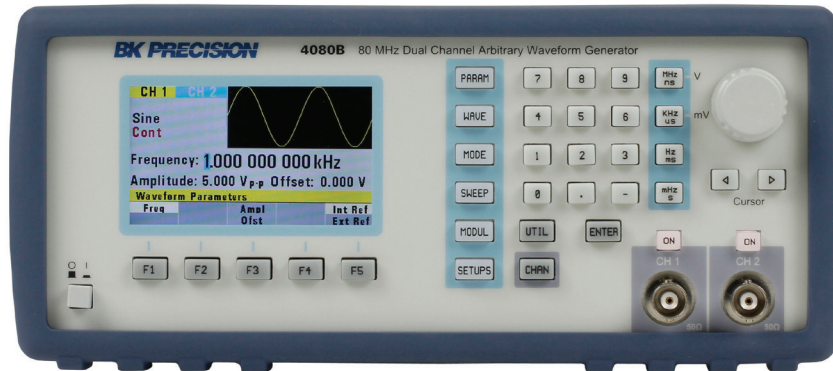

4075B Series Arbitrary/Function Waveform Generators

Dual architecture design

These generators combine the benefits of DDS (direct digital synthesis) and true AWG (arbitrary waveform generator) architectures without the limitations of either. Standard waveforms such as sine, square, and triangle are generated with a DDS chip, delivering great frequency resolution at a low cost. Custom arbitrary waveform generation is implemented with a true point-by-point design, offering improved signal integrity by producing significantly less jitter and distortion compared to a DDS-only architecture.

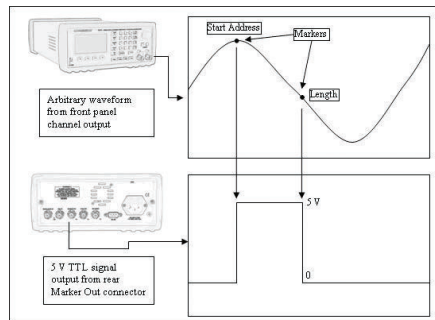

Programmable markers

The 4075B Series provides fully programmable markers that allow you to generate a positive TTL level output signal at the points specified by address in memory and length up to 4000 points.

Flexible memory management

The 4075B Series gives users more freedom by allowing the flash memory to be allocated via start address and length parameter setups. For instance, a model 4080B user could generate one large 16M-point waveform or up to 49 different waveform setups totaling 16 Mpts in one memory bank. Up to eight non-volatile memory banks are available to store arbitrary waveforms with 14-bit vertical resolution.

Features & Benefits

- 14-bit, 200 MSa/s, 16 Mpts arbitrary waveform generator
- Linear and logarithmic sweep
- AM/FM/FSK modulation
- Output ON/OFF button
- Gate and burst mode
- Fully programmable markers
- Store/recall up to 50 instrument settings
- SCPI-compliant command set
- Short circuit protection on output



Model	4075B	4078B	4076B	4079B	4077B	4080B
Channels	1	2	1	2	1	2
Sine frequency range	1 μ Hz – 30 MHz		1 μ Hz – 50 MHz		1 μ Hz – 80 MHz	
Square frequency range	1 μ Hz – 30 MHz		1 μ Hz – 50 MHz		1 μ Hz – 60 MHz	
Arbitrary waveform length	1 Mpts		4 Mpts		16 Mpts	
Remote interface	USB/TMC		USB/TMC and GPIB			

Signal Generators

Function Generators/AWG

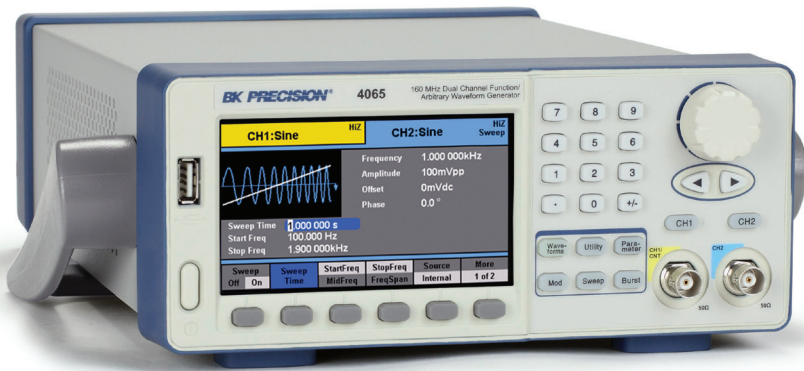

4060 Series Dual Channel Function/Arbitrary Waveform Generators

The 4060 Series Dual Channel Function/Arbitrary Waveform Generators are capable of generating stable and precise sine, square, triangle, pulse, and arbitrary waveforms. With an easy-to-read color display and intuitive user interface with numeric keypad, these instruments offer plenty of features including linear/logarithmic sweep, built-in counter, extensive modulation and triggering capabilities, a continuously variable DC offset, and a high performance 14-bit, 500 MSa/s arbitrary waveform generator.

Model	4063	4064	4065
Sine frequency range	1 μ Hz – 80 MHz	1 μ Hz – 120 MHz	1 μ Hz – 160 MHz
Square frequency range	1 μ Hz – 40 MHz	1 μ Hz – 50 MHz	
Weight	2.8 kg		
Dimensions (W x H x D)	261 x 105 x 344 mm		

Features & Benefits

- 14-bit, 500 MSa/s, 512k point arbitrary waveform generator
- Two independent channels with one button synchronization
- Large 4.3-inch LCD color display
- Linear and logarithmic sweep
- AM/DSB-AM/ASK/FM/FSK/PM/PWM modulation functions
- Variable DC offset
- Highly adjustable pulse duty cycle from 0.0001% to 99.9999%
- Internal/external triggering
- Gate and burst mode
- 36 built-in predefined arbitrary waveforms
- Store/recall up to 10 instrument settings and 32 user-defined arbitrary waveforms
- Built-in counter
- USB device port (USBTMC-compliant) with front panel USB host port
- GPIB connectivity with optional USB-to-GPIB adapter (model AK40G)
- Short circuit output protection
- LabVIEW drivers available

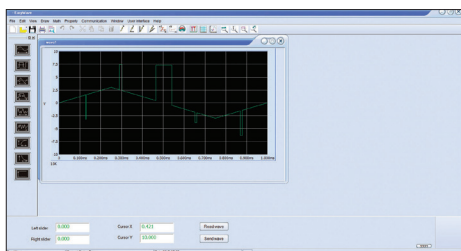

Generate waveforms with ease

The provided waveform editing software can be used to create point-by-point arbitrary waveforms via freehand or waveform math functions.



Synchronization and external triggering

Use the external 10 MHz clock input and output to synchronize your signals to a master time base.



Advanced pulse generator

The 4060 Series can generate pulses with minimum rise/fall times of 6 ns and maximum rise/fall times of 6 seconds.

Signal Generators

Function Generators/AWG

Dual-Channel Function/Arbitrary Waveform Generators

4047B

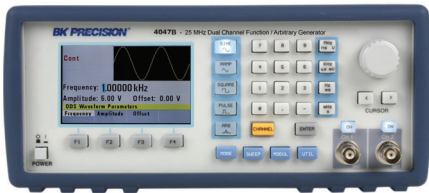

The 4047B is a versatile dual-channel 25 MHz function generator with arbitrary waveform capability. It features a true point-by-point AWG (arbitrary waveform generator) architecture to produce accurate and precise arbitrary waveforms combined with a DDS architecture offering easy-to-use conventional function generator capabilities.

Front panel arbitrary waveform generation

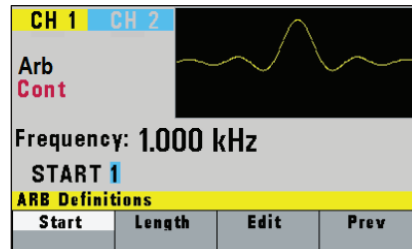

From the front panel, waveforms can be defined from scratch by entering data point-by-point or by loading and modifying predefined waveforms.



Waveform editing software

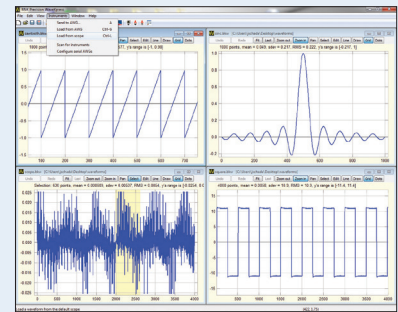

Use WaveXpress to easily generate, edit, and upload custom arbitrary waveforms to the generator via the remote interface. Generate waveforms in the software by importing a text file or define via freehand, point draw, and waveform math functions.

4050B Series



The 4050B Series dual-channel function/arbitrary waveform generators are capable of providing stable and precise sine, square, triangle, pulse, and arbitrary waveforms up to 60 MHz, using a DDS-based architecture.

Wide variety of modulation schemes

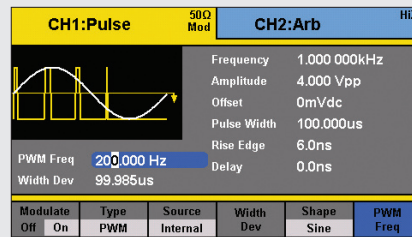

These instruments are capable of many different types of modulation for various applications.

Harmonics generator function

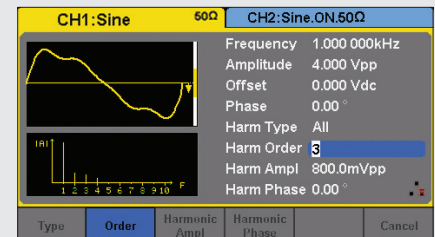

Generate up to 10 harmonics with independent amplitude and phase settings.

Common Features

- 4.3" color LCD display
- Two fully independent channels with individual output On/Off buttons
- Synchronize the phase of both channels with the push of a button
- Low-jitter square wave generation for simulating reliable clock signals, generating triggers, or validating serial data buses
- Linear and logarithmic sweep
- Variable DC offset
- Adjustable duty cycle
- Internal/external triggering
- Gate and burst mode
- Built-in frequency counter

Model	4047B	4053B	4054B	4055B
Sine & Square frequency range	0.01 Hz - 25 MHz	1 μHz - 10 MHz	1 μHz - 30 MHz	1 μHz - 60 MHz
Amplitude	0 - 10 Vpp into 50 ohms for entire frequency range	0 - 10 Vpp into 50 ohms, ≤ 10 MHz 0 - 5 Vpp into 50 ohms, >10 MHz		
Modulation	AM, FM, FSK, PM, PWM	AM, DSB-AM, FM, PM, ASK, FSK, PSK, PWM		
Vertical resolution	14 bit			
AWG architecture	True point-by-point AWG	DDS-based AWG		
Sample rate	125 MSa/s	150 MSa/s		
Arbitrary waveform length	16 kpts			
Built-in arbitrary waveforms	9	196		
Dedicated waveform keys	√	-		
Channel tracking	-	√		
Harmonics generator	-	√		
Ext 10 MHz reference I/O	-	√		
Remote interface	USB (Virtual COM)	LAN, USB device (USBTMC), USB host interface		

Signal Generators

Digital (DDS) Function Generators



Model 4005DDS



Model 4013B



Model 4045B

The 4005DDS is a versatile 5 MHz function generator using a DDS (direct digital synthesis) design. This model is great for education and other applications that need basic waveform generation.

Features & Benefits

- Sine, square, and triangle waveforms up to 5 MHz
- Numeric keypad for quick input of frequency
- Adjustable DC offset
- Adjustable duty cycle
- Front panel push button and pull knob can attenuate output by up to 40 dB

The 4007B, 4013B, 4014B, 4040B, and 4045B DDS function generators are capable of generating stable and precise waveforms. All models provide variable output amplitudes from 0 to 10 Vpp into 50 Ω and a continuously variable DC offset to inject signals into circuits at the correct bias level. Standard features include an intuitive menu-driven front panel keypad, rotary control knob, adjustable duty cycle, and comprehensive short circuit and overvoltage output protection.

Common Features

- Sine, square, and triangle waveforms
- Bright LCD display with waveform preview
- Linear and logarithmic sweep
- Store and recall instrument settings
- Output On/Off button

Additional Features (4014B/4040B/4045B)

- AM/FM modulation
- Low-jitter square wave generation for simulating reliable clock signals, generating triggers, or validating serial data buses
- Internal/external triggering
- Gate and burst mode (4040B)
- Built-in counter
- USB interface and SCPI-compliant command set
- Remote control application software provided
- Arbitrary waveform generation (4045B)

Specifications	4005DDS	4007B	4013B	4014B	4040B	4045B
Frequency (sine & square)	1 Hz - 5 MHz	0.1 Hz - 7 MHz	0.1 Hz - 12 MHz	0.01 Hz - 12 MHz	0.01 Hz - 20 MHz	0.01 Hz - 20 MHz
Output range (into 50 Ω)	10 mV - 10 Vpp					
Flatness	±0.3 dB to 1 MHz, ±1 dB to 5 MHz	±1 dB to 7 MHz	±1 dB to 12 MHz	±0.5 dB to 1 MHz, ±1 dB to 12 MHz	±0.5 dB to 1 MHz, ±1 dB to 20 MHz	
Arbitrary waveform generator	--	--	--	--	--	0.01 Hz - 20 MHz
Variable duty cycle	20% - 80% to 3 MHz for square	20% - 80% to 1 MHz for square		20% - 80% to 2 MHz for square, 1% - 99% in 1% steps for triangle		
Weight	2.3 kg	2 kg		2.5 kg		
Dimensions (W x H x D)	279.4 x 101.6 x 297.2 mm		213 x 88 x 210 mm			

Signal Generators

Performance Pulse



4033 & 4034 50 MHz Programmable Pulse Generators

The 4033 and 4034 are high performance programmable pulse generators ideal for testing digital systems and circuits based on TTL, CMOS, or ECL technologies. Both instruments generate clean and accurate pulses at up to 6 digits resolution with a repetition rate up to 50 MHz, variable pulse widths from 10 ns to 10 s, and pulse delays from 0 ns to 10 s. Output levels are adjustable from -10 V to +10 V, with pulse amplitudes settable from 0.1 Vpp to 10 Vpp into a 50 Ω load.

All parameters, modes, and functions are programmable via the front panel or remote control commands. Additionally, the pulse generators provide selectable complementary pulse and double pulse generation in continuous, triggered, gated, and counted burst modes.

Features & Benefits

- Repetition rate of 0.1 Hz to 50 MHz
- Flexible trigger modes: Continuous, Triggered (internal, external, manual), Gated Burst and External Width
- Pulse width programmable from 10 ns to 10 s
- Transition times (rise and fall times) variable from 6 ns to 100 ms
- Programmable delay and double pulse
- Predefined amplitude levels for ECL, TTL, and CMOS signals
- Store up to 99 different test setups with auto retention of last power down setup
- Pulse amplitudes up to 10 Vpp into 50 Ω output
- Programmable via GPIB and RS232
- SCPI compatible

Dual-Channel Model 4034

Users can save cost and bench space with two independent channel outputs. Both channels offer full functionality and all parameters such as pulse width and transition time can be set individually. The channels can also be synchronized with the push of a button.

Applications

- Automatic Test Equipment (ATE)
- Avionics and radar testing
- Switching power supply testing
- Characterization of active components

Specifications	4033	4034
Channels	1	2
Frequency	0.1 Hz to 50 MHz	
Period	40 ns to 10 s (25 MHz to 0.1 Hz repetition rate)	
Width	10 ns to (Period - 10 ns)	
Delay	0 ns to (Period - Width - 10 ns)	
Duty Cycle	1% - 99%	
Amplitude	0.1 V to 10 Vpp into 50 Ω load (20 Vpp max into open circuit)	
Transition Times	<6 ns to 100 ms variable. Leading and trailing edges settable separately and limited to 20:1 ratio between settings into one of the following ranges: 5 ns-100 ns; 50 ns-1.0 us; 500 ns-10 us; 5.0 us-100 us; 50 us-1.0 ms; 500 us-10 ms, 5 ms - 100 ms	

Signal Generators

Analog & Handheld



Model 4040A

Analog Function Generators

These analog function generators offer familiar controls, stable output, and reliable operation at budget-saving price points. While DDS generators have eclipsed analog generators at the high end, these analog generators are the workhorses of industry, education, and hobbyists.

Common Features & Benefits

- Variable output: 10 Vpp into 50 Ω (includes a 20 dB attenuator)
- TTL/CMOS output
- Adjustable DC offset
- Sine/square/triangle/ramp/pulse outputs

Models 4011A and 4012A are popular 5 MHz generators for general bench and lab use with an ideal mixture of features at a compelling price. The 4012A is identical to the 4011A, but with a sweep function added.

Specifications	4001A	4003A	4010A	4011A	4012A	4017A	4040A
Frequency range (sine)	0.5 Hz - 3 MHz		0.2 Hz - 2 MHz	0.5 Hz - 5 MHz		0.1 Hz - 10 MHz	0.2 Hz - 20 MHz
Frequency resolution	--	5 digits	--	4 digits			5 digits
Distortion	<2%, 1 Hz - 100 kHz		4% typical at 1 kHz		≤3% typical at 1 kHz		
VCG	--	√	√	√	√	√	√
AM/FM modulation	--	--	--	--	--	--	√
Linear/Log Sweep	--	--	--	--	√	--	√
Burst	--	--	--	--	--	--	√
Counter	--	up to 20 MHz	--	--	--	--	up to 30 MHz
Weight	2.5 kg		1.8 kg			2 kg	
Dimensions (W x H x D)	275 x 90 x 300 mm		298 x 114 x 264 mm			298 x 140 x 264 mm	



Model 3003

20 Hz-150 kHz Sine/Square Wave Audio Generator

The 3001 generates low-distortion sine waves at 46 discrete frequencies. Frequency accuracy is 3% from 20 Hz to 100 kHz. The unit is powered by a 9 V battery.

10 MHz Handheld Sine & Square Wave Signal Generator

The 3003 generates up to 10 MHz sine (adjustable amplitude from 0 to 4.5 Vpp, no load) and TTL square waves using DDS technology in steps of 0.1 Hz. Output frequency accuracy is 0.02%. The sine and square waves are available simultaneously from separate BNC female connectors. A 9 V battery supplies power or an external 6-9 VDC adapter can be used.

10 MHz Pulse Generator with 4-digit LED Display

The 4030 pulse generator supplies positive and negative 0.5-5 V pulses into 50 Ω at up to 10 MHz pulse repetition frequency (pulse periods from 100 ns to 100 ms). Pulse widths are continuously variable between 50 ns and 50 ms and the pulses have rise and fall times of 12 ns.

150 MHz RF Signal Generator

The 2005B supplies sine wave outputs from 100 kHz to 150 MHz (harmonics usable to 450 MHz) at up to 100 mV (RMS). An external crystal can be plugged in for precise frequency control. The output is provided via a BNC female connector.

Specifications	3001	3003	4030	2005B
Frequency Range	20 Hz - 150 kHz	0.1 Hz - 10 MHz	0.1 Hz - 10 MHz	100 kHz - 150 MHz
Output Voltage	> 1.2 V rms at max setting (no load)	0 to 4.5 Vpp (no load) (sine) 5 Vpp (no load) (square)	1 - 10 V	up to 100 mVrms
Output Impedance	600 Ω	50 Ω	50 Ω	50 Ω - 200 Ω
Weight	200 g	0.9 kg	2.5 kg	2.5 kg
Dimensions (W x H x D)	82 x 150 x 21 mm	97 x 145 x 38 mm	26.2 x 11.2 x 31.5 mm	250 x 150 x 130 mm

SPECTRUM ANALYZERS

Essential tools for RF measurements



Spectrum Analyzers

Handheld Spectrum Analyzers

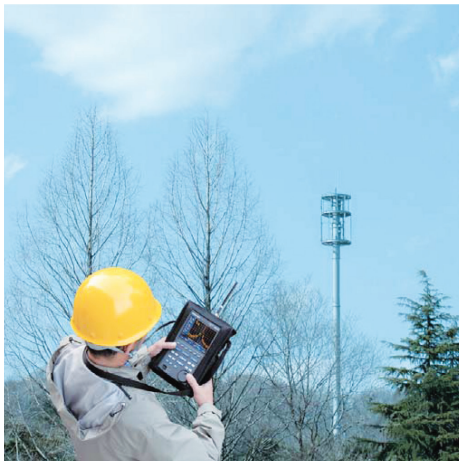

The 2650A series handheld spectrum analyzers are compact, lightweight, and cost-effective instruments for quick and precise signal investigations. At a weight of only 1.8 kg, the 2650A series are by far the lightest full-featured spectrum analyzer available, yet they deliver performance and features comparable to full-size bench spectrum analyzers and can operate up to 4 hours on a single battery.

With their ease of use, measurement flexibility, and unmatched portability, the 2650A series analyzers are indispensable tools for engineers and technicians who conduct field measurements in the 50 kHz to 8.5 GHz range.

Applications

- Installation, maintenance, and troubleshooting of wireless communication systems such as W-CDMA/CDMA, GSM, WLAN, WiMAX and Bluetooth
- Detection of signal interference and undesired emissions
- TV and broadcasting
- Antenna alignment
- Electric field strength measurement with dipole antennas optimized for typical frequencies used in wireless systems
- Magnetic field strength measurement with magnetic field probe (PR 26M)
- Frequency response measurements of passive components such as RF cables, filters, and attenuators using the built-in tracking generator (2652A)

Features & Benefits

- Frequency range from 50 kHz – 8.5 GHz
- Truly portable spectrum analyzer weighing only 1.8 kg including the battery
- Impressive 4 hour battery life; easy-to-replace rechargeable Lithium-Ion battery
- USB interface for PC connectivity
- Intuitive PC software for remote control and documentation of measurement results
- Conveniently store measurement results and screenshots in bitmap format to USB flash drive (USB host interface)
- Large easy-to-read color display
- Measurement functions: channel / adjacent channel power, occupied bandwidth, electric and magnetic field strength
- Convenient Auto Tune function automatically sets center frequency to the maximum signal within full span and optimum settings for RBW, VBW and sweep time
- External trigger for zero span measurements
- SCPI-like remote control commands

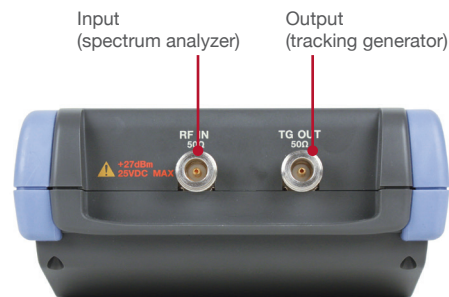

Tracking generator specifications (2652A)	
Frequency range	5 MHz - 3.3 GHz
Output level	-10 dBm ± 1 dB @ 1 GHz (output level is fixed)
Output flatness	±1.5 dB

Specifications	2650A/2652A	2658A
Frequency range	50 kHz - 3.3 GHz	50 kHz - 8.5 GHz
Resolution bandwidth	3 kHz to 3 MHz (1-3 sequence) and AUTO	
SSB phase noise	-90 dBc/Hz (typical) @100 kHz offset	
Average noise level	-127 dBm (typical) @ CF : 1 GHz, RBW : 3 kHz, VBW : 100 Hz, Ref. level < - 40 dBm (preamp automatically ON)	
Input VSWR	< 2.0	
Weight	approx. 1.8 kg (including battery)	
Dimensions (W x H x D)	162 x 71 x 265 mm	

Superb performance improves your productivity

- Advanced synthesizer-based design enables the 2650A series to provide you with an accurate and detailed picture of the spectrum you are investigating
- Fast sweep speed (minimum 10 ms) to help locate and identify elusive, transient interference signals
- DANL (displayed average noise level) of -127 dBm
- Single sideband phase noise – 90 dBc @ 100 kHz offset

Spectrum Analyzers

Handheld Spectrum Analyzers

Channel Power Measurement

Allows you to measure the total power or noise power in a user-specified bandwidth.

Adjacent Channel Power

Measures the ratio of power leakage (from the wanted signal) into adjacent channels. Center frequency, adjacent channel bandwidth, and offset between main carrier and adjacent channels can be set.

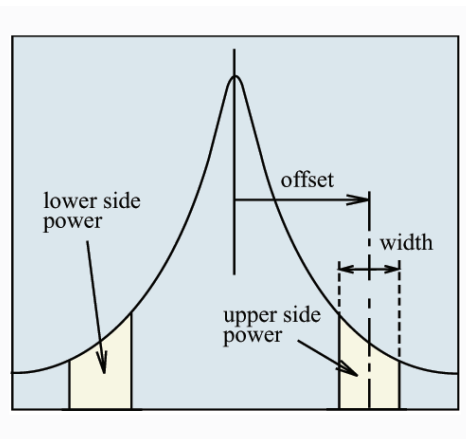

Marker Function

Two different modes are available for marker measurements:

- Normal marker mode measures the frequency and level of the marked point
- Delta marker mode measures the frequency and level differences between the two markers (see image below)

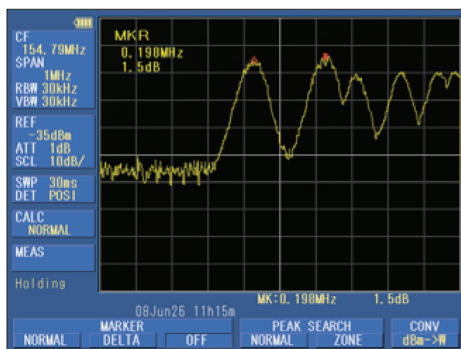

Electric Field Strength Measurement

An optional dipole antenna (models M401 thru M406) that connects to the RF input enables the measurement of electric field strength. Users can choose from 6 antennas based on the frequency range under investigation.

Combined with the MAX HOLD function and a 10 ms sweep time, the M404 dipole antenna is capable of measuring the electric field strength of Bluetooth systems and systems using direct sequence spread spectrum/frequency hopping modulation techniques.

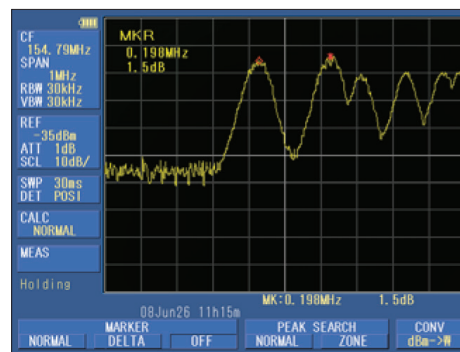

Magnetic Field Strength Measurement

Using a magnetic field probe (optional PR 26M), the 2650A series is capable of accurately measuring the magnetic field distribution on a PCB (printed circuit board) or IC (integrated circuit) over a wide frequency range of 10 MHz to 3 GHz. Since the probe's compensation data is already preloaded into the analyzer, the magnetic field strength is displayed directly in dBμA/m.

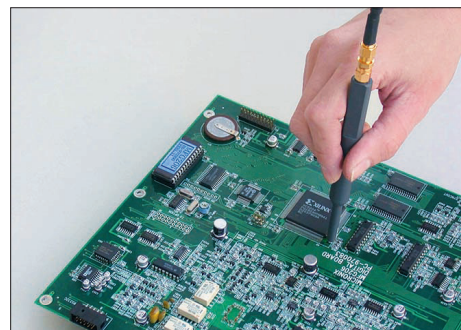

Easy Operation

The 2650A series are straightforward to operate and provide many functions to facilitate quick and easy measurements:

- Smart one button "Auto Tune" function which automatically scans the full frequency range, detects and centers the maximum signal, and configures optimum values for RBW, VBW, sweep time and reference level
- Input attenuator and internal preamp are set automatically to optimal values
- 200 setups of reference spectrum measurements can be stored and recalled from either internal memory or USB flash drive

PC Software for Simple and Flexible Documentation of your Measurements

The 2650A series includes easy-to-use software for documentation and further analysis of your measurements. Connect the analyzer via USB cable to your PC, configure the analyzer remotely, then download measurement data and instrument settings for storage and further analysis.

- Continuously sweep and transfer trace data to the PC
- Capture 1001 trace data points (twice the number of display dot) and store the data in CSV format
- Save the screen to a bitmap file

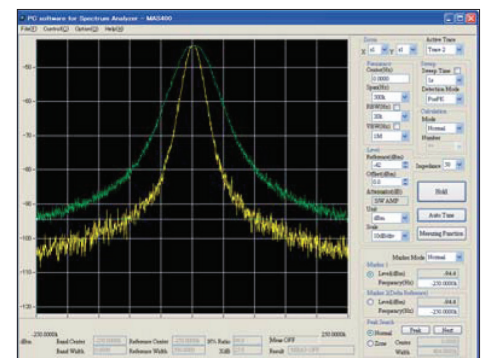

MULTIMETERS

Accurate and reliable measurements



Multimeters

Selection Guide

B&K Precision provides an extensive selection of multimeters. Our multimeters come in bench-top size for the engineering lab and handheld size for portable use. For electricians, we offer a series of current clamp meters to measure high current and voltage with reliability and safety.

	Display Counts	DCV Accuracy (%)	Analog Bar Graph	Auto/Manual Ranging	Manual Ranging	True RMS	Min/Max Hold	Peak Hold	Data Hold	Capacitance	Frequency	Logic Level	Transistor Gain (hfe)	Temperature	Relative Mode	dBm Measurement	Diode Test	Continuity Test	Max. Current Range (Amps)	Battery Life (Hours)	Auto Power off	PC Interface	Model	Page
Bench	20,000	0.03		√		√	√		√		√				√	√	√	√	20	N/A	N/A	√	2831E	62
	50,000	0.02		√		√	√		√		√				√	√	√	√	20	N/A	N/A	√	5491B	62
	120,000	0.01		√		√	√		√		√				√	√	√	√	12	N/A	N/A	√	5492B	62
Handheld	2,000	1.2			√												√	√	10	200	√	√	2703C	63
	2,000	1.2			√			√	√								√	√	10	200			2408	64
	2,000	0.8			√		√		√	√	√	√	√				√	√	10	150		√	2704C	63
	2,000	0.8			√	√	√		√	√	√	√	√				√	√	10	150		√	2707B	63
	2,000	0.5			√		√			√	√			√			√	√	0.2	150	√	√	2706B	63
	2,000	0.5			√												√	√	20	250	√	√	2860A	64
	3,200	1.2	√	√					√								√	√	10	500	√		2407A	64
	3,400	1	√	√		√			√								√	√	10	150	√	√	2708B	63
	4,000	1		√					√								√	√	10	200	√	√	2705B	63
	4,000	0.5			√			√	√	√	√	√	√				√	√	20	500	√	√	388B	64
	4,000	0.1	√	√			√	√	√	√	√			√	√		√	√	20	500	√	√	390A	64
	6,600	0.5		√		√	√			√	√					√	√	√	10	150	√	√	2709B	63
	20,000	0.05			√	√			√		√	√					√	√	20	500	√	√	391A	64
	40,000	0.1	√	√		√	√	√	√	√	√						√	√	10	150	√	√	2712	63
	60,000	0.08	√	√		√	√	√	√	√	√			√	√		√	√	20	500	√	√	393	64
Clamp Meters	2,000	N/A		√					√								√	√	600	1,000	√		312B	64
	2,000	0.5			√			√	√								√	√	1,000	300			330B	64
	4,000	0.5	√	√		√	√	√	√	√	√				√		√	√	2,000	100	√		367A	64
	4,000	0.5	√	√		√	√	√	√	√	√				√		√	√	1,000	100	√		369B	64
	10,000	1		√				√	√						√		√	√	600	50	√		313A	64
	10,000	1		√				√	√						√		√	√	100	45	√		316	64

Multimeters

Bench DMM's



5492B 5½-digit Multimeter

Model 5492B is a versatile 5½-digit, 120,000-count bench multimeter suitable for applications in education, service, repair, and manufacturing. This multimeter offers powerful features not commonly found in other 5½-digit DMMs such as advanced triggering, buffer storage operation, and a GPIB interface option.

Features and Benefits

- 5½-digit, 120,000-count display resolution
- 0.01% basic VDC accuracy
- Advanced triggering options such as external, bus and event trigger
- Two and four-wire resistance measurement up to 120 MΩ
- Limit mode for Pass/Fail testing
- Built-in math functions: Rel, Max/Min, dBm, dB, %, limits, Mx+B
- CAT I (1000 V) / CAT II (300 V) protection
- USB (Virtual Com), RS232 and GPIB (option) interface
- SCPI compatible

2831E 4 ½-digit and 5491B 50,000-count Multimeter

Bench Multimeters 2831E and 5491B provide accurate and reliable measurements for everyday use. These instruments measure volts, ohms, and amps with great accuracy and stability. Additionally, these meters enhance productivity with built-in math functions and USB connectivity for remote controllability.

Features and Benefits

- Up to 50,000 count display resolution
- Basic VDC accuracy of 0.02% for the 5491B and 0.03% for the 2831E
- Dual display to indicate two measurements simultaneously
- AC + DC True RMS
- Up to 25 readings per second measurement rate
- Built-in math functions: Rel, Max/Min, dBm, dB, %, Hold, Compare
- CATI (1000 V)/CATII (300 V) protection
- USB and RS232 (5491B only) interface
- SCPI compatible

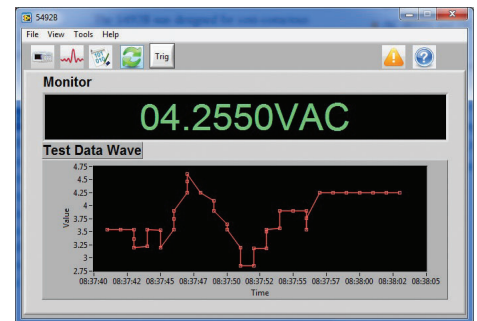

PC Connectivity (all models)

Programmable via USB, RS232, and GPIB (5492BGPIB only) interface using industry standard SCPI commands, these multimeters can be remotely controlled and configured from a PC. The multimeter can also be remotely controlled using application software (via USB & RS232), which supports front panel emulation and data logging of measurement results.

Specifications	DC volts			AC Volts		Weight	Dimensions (W x H x D)
	Ranges	Resolution	Basic accuracy	Ranges	Basic accuracy		
2831E	200m V, 2 V, 20 V, 200 V, 1000 V	10 uV, 100 uV, 1 mV, 10 mV, 100 mV	0.03%(reading)+0.06%(range)	200 mV, 2 V, 20 V, 200 V, 750 V	0.4%(reading)+0.05%(range) at 50-20 kHz, 2 V range	2.5 kg	225 × 100 × 355 mm
5491B	500 mV, 5 V, 50 V, 500 V, 1000 V	10 uV, 100 uV, 1 mV, 10 mV, 100 mV	0.02%(reading)+0.008%(range)	500 mV, 5 V, 50 V, 500 V, 750 V	0.35%(reading)+0.02%(range) at 50-20 kHz, 5 V range		
5492B	120 mV, 1.2 V, 12 V, 120 V, 1000 V	1 uV, 10 uV, 100 uV, 1 mV, 10 mV	0.01%(reading)+0.004%(range)	120 mV, 1.2 V, 12 V, 120 V, 750 V	0.1%(reading)+0.1%(range) at 50-20 kHz		

Multimeters

Handheld DMM's

B&K Precision's 2700 Tool Kit® Series

These meters are excellent for most jobs that require flexibility, accuracy, and speed. Value-packed features make these meters a must for everyone's "Tool Kit®".

Common Features & Benefits

- DC voltage measurement up to 1000 V
- AC voltage measurement up to 750 V
- DC current measurement up to 10 A
- Diode and continuity test
- Drop resistant case
- Magnetic hanging strap



Magnetic Hanging Strap

This convenient feature lets you hang your DMM on any magnetic metallic surface, freeing up your hands for troubleshooting.

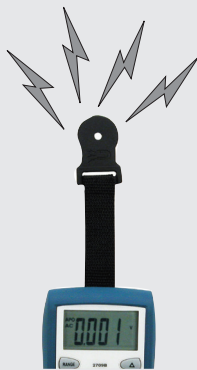

Single-handed Operation

The ergonomic design allows both left and right handed users to rotate the knob while holding the meter in one hand. While one hand keeps the probe on the circuit, the other hand changes the meter's function. This speeds up troubleshooting because you don't have to locate the probe point in the circuit again.

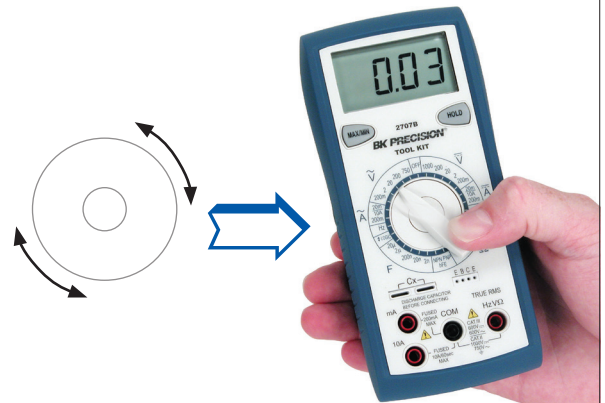

Specifications	2703C	2704C	2705B	2706B	2707B	2708B	2709B	2712
Ranging	Manual	Manual	Auto/Manual	Manual	Manual	Auto/Manual	Auto/Manual	Auto/Manual
True RMS	-	-	-	-	AC	AC	AC	AC + DC
Current	10 A DC	10 A AC/DC	10 A AC/DC	200 mA AC/DC	10 A AC/DC	10 A AC/DC	10 A AC/DC	10 A AC/DC
Capacitance	-	to 20 uF	-	to 20 mF	to 20 uF	-	to 66 mF	to 40 uF
Transistor test	-	√	-	-	√	-	-	-
Frequency counter	-	to 20 MHz	-	to 40 kHz	to 20 MHz	-	to 66 MHz	to 500 kHz
Temperature	-	-	-	√	-	-	-	-
Logic probe	-	√	-	-	√	-	-	-
Backlight LCD	-	-	-	√	-	-	√	√
Analog bar graph	-	-	-	-	-	√	-	√
Battery test	√	-	-	-	-	-	-	-
Auto power off	√	-	√	√	-	√	√	√
Weight	283 g							
Dimensions (W x H x D)	78 x 163 x 42 mm							

Multimeters

Digital Handheld & Clamp-on



The Test Bench® Series are high performance and value-priced, portable multimeters, offering more features for the dollar than other multimeters. These meters measure resistance, capacitance, frequency, and temperature. This series also includes a logic indicator and component test function.



The Mini-Pro® Series offers the hobbyist a good choice for performing 90% of most basic electrical measurements such as DC/AC voltage, DC current, and resistance. Compact in size and low in cost, these meters are great to have in every toolbox and field service kit.

Specifications	Mini-Pro®		Survivor®	Test Bench®			
	2408	2407A	2860A	388B	390A	391A	393
Display counts	2,000	3,200	2,000	4,000	4,000	20,000	60,000
Basic DC accuracy	1.2%	1.2%	0.5%	0.5%	0.1%	0.05%	0.08%
Ranging	Manual	Auto	Manual	Manual	Auto/Manual	Manual	Auto/Manual
Current	10 A	10 A	20 A	20 A	20 A	20 A	20 A
USB	-	-	-	-	√	-	√
Bar graph	-	√	-	-	√	-	√
Auto Power Off	-	√	√	√	√	√	√
Continuity	√	√	√	√	√	√	√
Data hold	√	√	-	√	√	√	√
Max. hold	√	-	-	-	√	-	√
Weight	206 g		353 g	320 g		400 g	
Dimension (W x H x D)	57 x 143 x 35 mm		89 x 175 x 38 mm	89 x 198 x 40 mm			

Clamp-on Meters

B&K Precision offers a variety of current clamps from small to large, for safe non-invasive current measurements. These meters also measure voltage and resistance. Some models even support frequency and capacitance measurements, and include special features such as recording capabilities of minimum and maximum values, peak values, and diode testing.

Common Features & Benefits

- AC voltage and current measurements
- Resistance measurements
- Audible continuity
- Data hold
- Low battery indicator
- Overload protection
- CE mark



Specifications	316	312B	313A	330B	350B	369B	367A
Display counts/digits	10,000	2,000	10,000	2,000 A	3,200	4,000	4,000
True RMS	-	-	-	-	-	√	√
AC current	100 A	600 A	600 A	1,000 A	1,000 A	1,000 A	2,000 A
DC current	100 A	-	600 A	-	-	1,000 A	2,000 A
AC voltage	600 V	600 V	600 V	750 V	750 V	750 V	750 V
DC voltage	600 V	-	600 V	1,000 V	1,000 V	1,000 V	1,000 V
Resistance	10 kΩ	200 Ω	1,000 Ω	2,000 MΩ	30 MΩ	40 MΩ	40 MΩ
Frequency	-	-	-	-	√	√	√
Continuity	√	√	√	√	√	√	√
Capacitance	-	-	-	-	-	√	√
Weight	180 g	210 g	220 g	482 g	482 g	482 g	
Dimensions	70 x 202 x 34 mm	50 x 187 x 29 mm	70 x 192 x 34 mm	91 x 274 x 43 mm	91 x 274 x 43 mm		

Electrical Testers



Model 310



Model 325

302 Phase and Motor Rotation Meter

The 302 is a 3-phase presence and rotation meter combined with a 3-phase motor rotation tester. It provides the quickest and easiest means for servicing and repairing 3-phase systems and 3-phase rotating machinery.

307A & 308A Insulation Tester

The battery-powered insulation testers models 307A and 308A are intended primarily for periodic testing of industrial motors, transformers, electrical wiring, and cable insulation. Low readings may point to insulation deterioration that can indicate impending failure.

Features & Benefits

- Selectable 250 V, 500 V, or 1000 V insulation test
- Low resistance test
- Extra rugged integral carrying case
- Live circuit indicator warns of safety hazard
- IEC / 61010-1 CAT III 600V / CE

Specifications	307A	308A
Type	Analog	Digital
Output voltage	1,000 VDC	1,000 VDC
Maximum current	1.3 mA	1.2 mA
Resistance range	0-400 MΩ	0-2,000 MΩ
Center scale	1 MΩ, 2 MΩ, 4 MΩ	Does not apply
Weight	925 g with batteries	
Dimensions (W x H x D)	180 x 220 x 90 mm	

309 Digital Earth Resistance Meter

The 309 digital earth resistance meter (also known as an earth ground meter) is a small, compact, battery-powered, professional meter that is easy-to-use and invaluable to electricians and contractors who need to ensure the "ground" quality and effectiveness of buildings, structures, equipment or electrical systems. A good earth ground is required for new buildings or structures needing to pass required electrical codes. Older buildings can lose a good effective earth ground connection over time or after being struck by lightning.

310 Digital Milli-ohm Meter

The 310 digital milli-ohm meter is used to ensure continuity and integrity of a wire, cable, conduit, or any electrical connection. The 310 has a display resolution of 100 μΩ and include a professional 4-wire Kelvin test lead set to ensure accurate readings. The heavy duty case comes with a convenient shoulder strap and has a rubber seal to make the unit water resistant.

325 True RMS AC/DC Power Clamp Meter

The 325 AC/DC true RMS power clamp meter provides safe, non-invasive measurements of up to 400 kW, 400 A AC, and measures up to 600 V AC/DC utilizing the pair of standard test leads. The lightweight, portable, battery-powered clamp meter measures parameters needed to troubleshoot residential and small commercial electrical systems such as ACV, DCV, ACA, DCA, Ω, W, frequency and continuity.

Features & Benefits

- 3 ¾ digit backlit LCD display
- Auto range
- Auto power off
- Data hold
- High speed digital bargraph
- Jaw opening (35 mm)
- IEC / 61010 CAT III 600 V / CE

Specifications	325
DC current	
Range	400 A, 600 A
Resolution	0.1 A, 1 A
Accuracy	1.5% + 5 digits
	2% + 5 digits
AC current (True RMS : From 10% to 100% of range)	
Range	400 A, 600 A
Resolution	0.1 A, 1 A
Accuracy	
40 Hz- 65 Hz	2.0% + 5 digits
65 Hz - 1 kHz	3.0% + 8 digits

Device-Programmiers & Counters

844USB, 866C & 867C EPROM Programmiers



Model 867C

Universal device programmers are powerful, versatile, and simple to use. Our programmers are the ideal solution for programming new chips as well as copying chips for backup or repair purposes.

We offer on-going program software updates that extend device libraries and provide continuous improvements for both models 844USB and 866C programmers. Whether you are working with PLCC, SOIC, TSOP, DIP, TQFP, SSOP, PSOP or QFP packaging, we provide an extensive line of socket adapters that will work in conjunction with our programmers.

Common Features & Benefits (EPROM)

- Extensive device libraries
- Fast and high performance
- Powerful program software
- Supports Windows® 10



Deluxe EPROM Eraser

The model 851 is a heavy duty EPROM eraser that can simultaneously erase up to 40 twenty-four pin EPROM chips. It is constructed of an all-metal case, and is designed with a chip drawer that protects the user from UV radiation exposure. The drawer is lined with conductive foam to prevent electrostatic damage to the chips. A 30-minute timer is provided to control timing of UV exposure.

Specifications	844USB	866C	867C
Devices supported	EPROM, EEPROM/Flash, Serial EPROM, Microcontroller, PLD and Bi-Polar PROM (Bi-Polar PROMs 866C, & 867C)		
Device libraries	over 32,900	over 88,000	over 90,000
Interface	USB 2.0 / USB 1.1 compatible		
Programming socket	DIL40 pin ZIF socket, ISP for in-circuit programming	DIL48 pin ZIF socket, ISP for in-circuit programming	
Buffer features	Erase, Random Data Fill, Fill Block, Copy Block, Move Block, Swap Block, Buffer Print, Find Text, Replace Text, GoTo Address, Checksum Calculator, 8 bit & 16 bit View Modes		
I.C. tester	No	Yes	
Power requirements	100-240 VAC, 47-63 Hz		
Weight	500 g	0.9 kg	
Dimensions (W x H x D)	95 x 35 x 160 mm	140 x 56 x 195 mm	

Windows® is a registered trademark of Microsoft Corporation in the United States and other countries.

1823A & 1856D Counters



Model 1823A

The 1823A and 1856D are reciprocal 2.4 GHz and 3.5 GHz universal frequency counters that are microprocessor controlled. Their LED displays can provide up to nine digits of resolution using an external time base with a 10 s gate time. The high accuracy, sensitivity and versatility of these counters make them an extremely valuable instrument to scientists, engineers, experimenters, and communications technicians for a broad spectrum of laboratory and service applications.

Features and Benefits

- ±1 ppm Time base stability
- Trigger level function (1823A only)
- Frequency ratio measurement function (1823A only)
- Time interval measurement function (1823A only)
- RPM measurement function (1856D only)
- External frequency standard input
- Bright LED display
- Attenuator
- RS232C Interface

Specifications	Range	Frequency Totalize. Period	Time Base Stability	Best Resolution	No. of Digits	Display Hold	Low Pass Filter	Remote Interface	Time Interval Measurement	Frequency Ratio Measurement	Weight	Dimensions (W x H x D)
1823A	0.1 Hz - 2.4 GHz								✓	✓		
1856D	0.1 Hz - 3.5 GHz	✓	±1ppm	1 nHz	9	✓	✓	RS232	-	-	2.5 kg	239 x 89 x 269 mm

Video & Cable / Environmental Testers

1211E & 1257 NTSC Generators

Models 1211E and 1257 are handheld models that provide standard test patterns used to test picture quality. These patterns include NTSC color bars, crosshatch, dot, staircase, circle, center cross, windows, and a full range of color raster patterns.



Model 262

262 Tone Generator & Cable Tracer Kit

The 262 kit comprises two handheld, battery-powered instruments designed to perform a variety of tests on unenergized telephone lines or LAN cables. The tone generator has alligator clips and a standard RJ11 plug, allowing the tone generator to be connected to stripped wires, terminal panels, wall plates, or modular single line jacks. The cable tracer can trace the signal from the tone generator signals through dry wall, wood, and many other non-metal surfaces to help identify wires and their location without piercing the insulation.



Model 231A

231A Deluxe Multi-network Cable Tester

The 231A can easily read the correct pin configuration of 10BaseT cable (category 5), 100BaseTx, 10Base2 cable (coax) and RJ45/RJ11 modular cables, 356A, TIA 568A, TIA 568B and Token Ring cables by comparing one transmitting end to the corresponding receiving end. With the remote kit, it can test cables installed far away either on wall plate or patch panel up to 1000 ft away. It is easy to verify the cable continuity, open, short, and cross connect, featuring auto or manual scan for pin-out indicators.

Category	Model	Description
Network cable testers	231A	Deluxe multi-network cable tester
Tone generator & cable tracer	262	Tone generator & cable tracer kit
NTSC Generators	1211E	Handheld NTSC generator with audio output
	1257	Portable NTSC generator with RF output

Digital Infrared Thermometer

Compact, handheld infrared digital thermometers with laser pointer and adjustable emissivity designed for simple one-hand operation. These meters make non-contact temperature measurements and display the values in both °F and °C.



Model 732A

Model 636

732A & 735 Sound Level meters

Two handheld meters that measure sound level from 30 to 130 dB with both A and C frequency weighting. Both meters meet IEC 651 type II standards.

Category	Model	Description
Air velocity meter	731A	Anemometer with wand probe
Digital carbon monoxide meter	627	Carbon monoxide (CO) meter
Digital infrared thermometer	636	Non-contact infrared thermometer with laser pointer
Digital light meter	615	Light meter
Digital thermo-hygrometer	625	Thermo-hygrometer
	720	Humidity/temp meter w/dual input
	725	Datalogging humidity/temp meter w/dual input
Digital thermometer	630	Dual K-type thermometer
	710	Temperature meter, dual input
	715	Datalogging temperature meter, dual input
Sound level calibrator	CAL73	Standard acoustic calibrator (94 dB, 1 kHz sine wave)
Sound level meter	732A	Digital sound level meter with RS 232 capability
	735	Datalogging digital sound level meter w/RS232 software & cable

General Accessories

Power Supply & Oscilloscope Probes



TLPWR1 High Current Premium Test Lead Accessory

High quality red and black cable with externally braided wrap with large fork-type spade connectors for connecting to high current power supplies or DC loads.

- Length: 2 m
- Rated current: 60 A
- Gauge: 8 AWG
- Connector inner diameter: 8 mm (approximate)
- Connector outer width: 15 mm (approximate)
- Wire material: flexible silicon jacket



CC545 General Purpose Power Supply Accessory Kit

This kit provides everything needed to put a bench power supply to work. The kit includes 3 high capacity test leads with retractile sleeve plugs. Rated at 600 V CAT II and 36 A, the leads provide safe connection to either standard or sheathed jacks while its silicone jacket wire stays flexible under all conditions.

- High capacity retractable sheath silicone jacketed leads
- Extra-large insulated alligator clips
- Black, red and green components
- Storage case

Description	Qty.	IEC rating	Max current
Retractable lead, 100 cm	*3	600 V CAT II	36 A
6/4mm spade lug adapter	*3	33 Vdc/ 70 Vac	36 A
BNC cable assembly, 100 cm	1	500 Vrms	3 A
BNC female to double banana plugs	1	500 Vrms	3 A
Banana plug adapter	*3	33 Vdc/ 70 Vac	36 A
BNC male to double binding posts	1	500 Vrms	3 A
Insulated alligator clip	*3	600 V CAT IV	36 A

*Colors: Black, red & green



TLPS Power Supply Accessory Kit

This accessory kit combines safety and functionality. A must have for anyone who uses a power supply, this kit is ideal for use with power supplies in educational, service and maintenance, and manufacturing applications.

- Medium and large insulated alligator clips
- Black and red components
- Sense lead included

Description	Qty.	IEC Rating	Max current
Retractable leads, 120cm	*2	600 V CAT II	25 A
6/4mm Spade lug adapters	*2	33 VDC/ 70 VAC	36 A
Standard alligator clips	*2	300 V CAT I	3 A
4mm Banana plug adapters	*2	33 VDC/ 70 VAC	36 A
Insulated alligator clips	*3	600 V CAT IV	36 A
Sense lead pair, 1 m	*1	33 VDC/ 70 VAC	3 A

*Colors: Black & Red

TL 5A & TL 30 Power Supply Leads



TL 5A



TL 30

Description	Qty.	IEC rating	Max current	Model
Leads, 4 mm banana plug leads, 100 cm	*2	33 VDC/ 70 VAC	5 A	TL 5A
Cables, #10 lug to battery clip, 75 cm	*2	33 VDC/ 70 VAC	30 A	TL 30

*Colors: Black & Red

CP62 300 kHz AC/DC Oscilloscope Current Clamp Probe

The CP62 current probe allows a general purpose oscilloscope to display AC and DC current signals up to 100 A Peak (70 A RMS). The CP62 current probe can also make AC and DC measurements with a multimeter by using the recommended accessory TL62 (BNC-to-banana) plug adapter.

- 50 mA to 100 Apk
- DC to 300 kHz



General Accessories

Oscilloscope Probes



PR-60 Active Differential Probe

Allows for safe and accurate floating measurements with your standard analog or digital oscilloscope.

Applications

- Switching power supply designs
- Motor drive design
- Electronic ballast design

Specifications	PR-60
Bandwidth	25 MHz (-3 dB)
Attenuation ratio	x10/x100
Accuracy	±2%
Rise time	14 ns
Input impedance	4 MΩ/10 pF each side to ground
Input voltage	
Max. differential	±700 V (DC+Peak AC)
Max. common mode	±700 V (DC+Peak AC)
Output voltage	
Max. amplitude	±7 V (into 2 kΩ load)
Offset (Typical)	≤±5 mV, -10° to 40° C
Noise (Typical)	1.5 to 2 mV
Source impedance	1 Ω @ 1 kHz 8 Ω @ 1 MHz
CMRR	
50Hz	86 dB
20kHz	66 dB
200kHz	56 dB
Probes	Sprung hooks (B/R)
Length of input lines	45 cm
Operating temperature	14° to 104°F (-10° to 40°C)
Power requirements	4 x AA batteries
Certification	IEC61010-1 CATIII

Passive Oscilloscope Probes

High bandwidth, high impedance 10x passive voltage probe with 10 MΩ input impedance. All probes are RoHS (2002/95/EC) compliant.



Specifications	PR150B	PR250B	PR500B	PR2000B
Type	5 mm Passive Voltage			
Bandwidth	17/150 MHz	250 MHz	500 MHz	200 MHz
Attenuation	1x/10x	10x	10x	100x
Input impedance	1/10 MΩ	10 MΩ	10 MΩ	100 MΩ
Input capacitance	≈45/12 pF	≈12 pF	≈10 pF	≈5 pF
Rise time	20/2.3 ns	1.4 ns	0.7 ns	1.8 ns
IEC rating	300 V CAT II	300 V CAT II	300 V CAT II	2,000 V CAT I
Compensation	10–30 pF	10–30 pF	6–22 pF	10–30 pF
Cable length	1.2 m			
Attenuation accuracy	-	-	-	6%
Voltage coefficient (VCR)	-	-	-	≤30 ppm/V
Operating temperature	0° to +50° C			
Humidity	85% RH or less (at 35° C)			

PR 32A RF Detector Probe



Specifications	PR 32 A
Bandwidth	100 kHz - 650 MHz
Accuracy	±3 dB
Voltage	200 V
HF voltage	50 Veff
Actuating Voltage	250 mV
Input capacitance	5 pF
Cable length	1.2 m
Body color	Black

General Purpose Passive Probes

This full line of probes increases the versatility of your oscilloscope with both fixed and switchable attenuation. Each probe includes a full accessory kit with a sprung hook, replacement tip and BNC adapter. All models are compliant to IEC61010-031.

Specifications	Passive probes			High voltage (passive)	
	PR 33A	PR 37 AG	PR 37AR	PR 100A	PR-55
Bandwidth (MHz)	15/90	6/150	6/150	250	50
Attenuation	x1/x10	x1/x10/REF	x1/x10/REF	x100	x1000
Input impedance R(MΩ)	1/10	1/10	1/10	100	100
Capacitance (pF)	46/16	100/15	100/15	6.5	1
Voltage (VDC+AC max)	600	600	600	1,200	10,000
Compensation (pF)	10-35	10-35	10-35	10-35	10-30
Cable length	1.2 m	1.2 m	1.2 m	1.2 m	2.0 m



Model PR-55

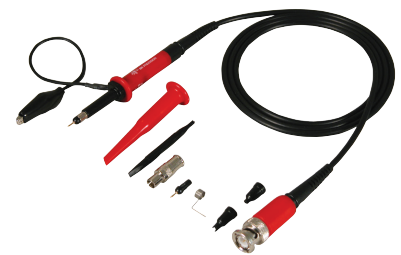

Model PR 37AR

General Accessories

Signal Interconnect Kits



CC 510 General Purpose Function Generator Kit

This kit provides a range of BNC and N Type coaxial interconnection for basic function / arbitrary waveform generators use. All components feature standard BNC or N Type interfaces with 50 Ω impedance and gold plated center contacts to ensure accurate repeatable measurements. The kit is provided in a convenient foam lined storage case for easy selection and use.

Description	Qty.	Frequency range	Max. VSWR
BNC cable assembly, 100 cm	2	DC - 1 GHz	1.20:1 @ 1 GHz
BNC feed-thru terminator, 2 W	1	DC - 1 GHz	1.20:1 @ 1 GHz
BNC tee, female-male-female	1	DC - 4 GHz	N/A
BNC female to double banana plugs	2	N/A	N/A
BNC female to N type male	1	DC - 4 GHz	1.30:1 @ 4 GHz
BNC female to N type female	1	DC - 4 GHz	1.30:1 @ 4 GHz
BNC attenuator, 20 dB (10x) 2 W	1	DC - 4 GHz	1.25:1 @ 4 GHz

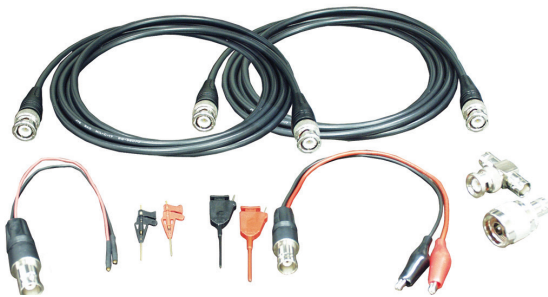

TLFG Function Generator Accessory Kit

The kit provides convenience and functionality to get a user up and running quickly. The kit eliminates the time consuming start-up task of collecting cables and adapters.

Description	Qty.	Frequency range	Max. VSWR
BNC cable assembly, 120 cm	2	DC - 1 GHz	1.20:1 @ 1 GHz
BNC (f) breakout w/miniature alligator clips	1	DC - 1 GHz	N/A
BNC (f) breakout w/Ø.031 sockets	1	DC - 1 GHz	N/A
MiniFlex IC clips, black & red pair	*2	N/A	N/A
MicroFlex IC Clips, black & red pair	*2	N/A	N/A
BNC tee, female-male-female	1	DC - 4 GHz	N/A
BNC female to N type male	1	DC - 4 GHz	1.30:1 @ 4 GHz

*black & red pair

CT 2701 General Purpose Universal Coaxial Adapter Kit

This kit provides a convenient solution for most interconnection needs. The included 6 universal adapters allows assembly of hundreds of different configurations: male-to-male, female-to-female, male-to-female, in-series and between-series for BNC, TNC, N-Type, F, RCA, SMA, UHF and Mini-UHF.



- Convenient interconnection kit
- BNC, TNC, N, SMA, RCA, F, SMA & Mini-UHF connectors
- Tarnish resistant nickel finish
- Gold plated center contacts
- Zippered storage case

Description	Qty.
Universal adapters	6
BNC male adapters	2
BNC female adapters	2
F male adapter	1
F female adapter	1
N Type male adapters	2
N Type female adapters	2
RCA male adapter	1
RCA female adapter	1
SMA male adapter	1
SMA female adapter	1
TNC male adapters	2
TNC female adapters	2
UHF male adapters	2
UHF female adapters	2
Mini-UHF male adapter	1
Mini-UHF female adapter	1

CC500 General Purpose BNC & N Type Adapter Kit

This general purpose BNC & N type adapter kit provides a comprehensive range of in-series and between-series BNC and N type coaxial adapters for basic RF testing and troubleshooting needs.



- 12-piece kit
- BNC & N type 50 Ω connectors
- Gold plated center contacts
- Storage case

Description	Qty.	Frequency range	Max. VSWR
BNC tee female-male-female	1	DC - 4 GHz	N/A
N type female-female	1	DC - 8 GHz	1.30:1 @ 8 GHz
N type male-male	1	DC - 8 GHz	1.30:1 @ 8 GHz
N type tee female-male-female	1	DC - 8 GHz	N/A
BNC female to N type male	1	DC - 4 GHz	1.30:1 @ 4 GHz
BNC male to N type female	1	DC - 4 GHz	1.30:1 @ 4 GHz
BNC female-female	1	DC - 4 GHz	1.30:1 @ 4 GHz
BNC male-male	1	DC - 4 GHz	1.30:1 @ 4 GHz
BNC female to N type female	1	DC - 4 GHz	1.30:1 @ 4 GHz
BNC Tee female-female-female	1	DC - 4 GHz	N/A
N type tee female-female-female	1	DC - 8 GHz	N/A
N type right-angle male-female	1	DC - 8 GHz	1.35:1 @ 8 GHz

General Accessories

Multimeters



PR 28A 40 kV High Voltage DMM Probe

For voltage measurements above the specifications of general purpose probes.

Specifications	PR 28A
Attenuation	x1000
Voltage (AC)	20 kV
Voltage (DC)	40 kV
Bandwidth	60 Hz
Input impedance	1000 MΩ
Accuracy (AC & DC)	±3%
Cable length	1.2 m



TL-50B Maxi-Pro DMM Kit

Complete accessory kit for all your testing needs. Includes soft, flexible silicone lead wire for easy movement.

- IEC61010-031 compliant
- Silicone lead wire length (1.5 m)
- Tri-fold velcro pouch

Description	TL-50B		
4 mm straight to right-angle silicone leads, 1.5 m	1000 V	CAT III	12 A
Probe bodies w/Ø2 mm tip	1000 V	CAT III	36 A
Pincer style clips	1000 V	CAT III	6 A
Alligator clips	300 V	CAT I	3 A
Spade lug adapters	42 V (1000 V)	-	36 A
Banana plug adapters	42 V (1000 V)	-	36 A
Fully insulated alligator clips	1000 V	CAT III	20 A

TL 8 Surface Mount Tweezers

- Two conductor leads
- 400 Vrms, 1 A



TL500B High Performance Bench DMM Accessory Kit

This kit of accessories was assembled to facilitate requirements by high-performance bench digital multimeters (DMMs) users. All the most popular accessories in one kit. The kit offers MiniProbe test probe, with spring-loaded tips for fine probing; MiniPRO and MiniFlex test clips for small and micro connections; and for those larger test points, both spade lug and banana plug adapters, two pairs of test leads for 4-wire measurements or calibration hookups, an insulated BNC male to sheathed banana jack adapter, and an insulated SMD tweezer set for surface-mount component testing.

- Silicone jacketed test lead wire
- MiniProbe w/spring loaded stainless steel tips
- Packaged in plastic case
- RoHS (2002/95/EC)

Qty.	Description	Color
(4)	Test lead 4 mm sheathed P-RaP silicon 0.75, 100 cm	(2) black, (2) red
(2)	Spring tip MiniPRO - 4 mm jack	(1) black, (1) red
(1)	Insulated BNC male adapter - 4 mm safety jacks	-
(2)	Adapter - 4 mm banana plug to jack	(1) black, (1) red
(2)	MiniFlex clip - 4 mm jack-silicon 0.40, 10 cm	(1) black, (1) red
(2)	Adapter 6 mm spade 4 mm jack	(1) black, (1) red
(2)	Lead MiniPRO-J-PVC 0.40, 10 cm	(1) black, (1) red
(1)	Tweezer test lead set- 4 mm P, w/PVC pouch	-



TL37 Red and Black CAT III 1000 V (CAT IV 600 V) Test Leads

Right angled sheathed banana replacement 10A test leads for digital multimeters. With tip cap on, they are rated to CAT III 1000V, CAT IV 600V, with tip cap off, they are CAT II 1000V.



TL 130B General Purpose DMM Kit

If you need only one basic accessory kit for your meter, this is the one. Attach probes or clips to the sheath plug to complete your test. Soft, flexible silicone leads make movement easy. Kit is voltage and current rated for electronic or electrical applications.

- IEC61010-2-031 compliant
- Silicone lead wire length (1.5 m)
- Tri-fold velcro pouch

Description	TL 130B		
4 mm straight to right-angle silicone leads, 1.5 m	1000 V	CAT III	12 A
Probe bodies w/Ø2mm tip	1000 V	CAT III	36 A
Alligator style clips	1000 V	CAT III	20 A
Alligator clips	300 V	CAT I	3 A

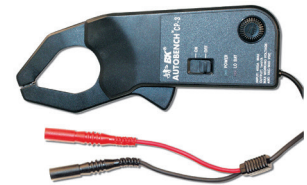

CP3 DC/AC Current Clamp

- Converts any DMM to a current clamp
- Measures current without disconnecting circuit under test
- Measures to 400 A DC or AC
- Outputs 1 mV per Amp, operates on 2 V range of any DMM

Specifications	CP 3
(Accuracy specified at 18° to 28°C)	
Current range	2 A to 400 A, DC or AC
Frequency Response (AC)	50 Hz - 400 Hz
Accuracy	±(2% reading + 2 A)
Input resistance	10 kΩ min.
Maximum conductor size	30 mm
Power requirement	9 V battery, NEDA 1604
Battery life	100 hr typical
Operating temperature	0° to 40°C, <70% RH
Storage temperature	-20° to + 70°C, <80% RH

Index



Model	Page	Model	Page	Model	Page	Model	Page	Model	Page	Model	Page
231A.....	67	1211E.....	67	2407A.....	61,64	4017A.....	49,56	9120A.....	15	PR 28A	71
262.....	67	1257.....	67	2408.....	64	4030.....	49,56	9121A.....	15	PR 32 A	69
307A.....	65	1513.....	18	2511.....	36	4033.....	49,52	9122A.....	15	PR 33 A	69
308A.....	65	1514.....	18	2512.....	36	4034.....	49,52	9123A.....	15	PR 37 AG	69
312B.....	61,64	1550.....	17	2515.....	36	4040A.....	49,56	9124.....	15	PR 37 AR	69
313A.....	61,64	1621A.....	17	2516.....	36	4040B	54	9129B	11	PR-55	69
316.....	64	1623A.....	17	2540C	31,33-34	4045B	50,54	9130B	11	PR-60	69
325.....	65	1627A.....	17	2544C	34	4047B	49,53	9131B	11	PR150B.....	69
367A.....	61,64	1651A.....	18	2550.....	31	4053B	49,53	9132B	11	PR200B.....	69
369B	61,64	1652.....	18	2552.....	35,50	4054B	49,53	9151.....	13	PR250B.....	69
388B	61,64	1653A.....	21	2553.....	35,50	4055B	49,53	9152.....	15	PR500B.....	69
390A.....	61,64	1655A.....	21	2554.....	35,50	4063.....	49,52	9171B	6	PR2000B	69
391A.....	61,64	1665.....	17	2555.....	35,50	4064.....	49,52	9172B	6	PVS10005	69
392.....	64	1666.....	17	2556.....	35,50	4065.....	49,52	9173B	6	PVS60085	69
393.....	64	1667.....	17	2557.....	35,50	4075B	49	9174B	6	PVS60085MR	69
570A.....	39,43	1670A.....	18	2558.....	35,50	4076B	49,51	9181B	6	SDL-1000-25	28
575A.....	39,43	1671A.....	18	2559.....	35,50	4077B	49,51	9182B	6	SDL-1000-50	28
600B	45	1672.....	18	2560.....	31	4078B	49,51	9183B	6	SDL-600-150	28
601B	45	1673.....	18	2563.....	32	4079B	49, 51	9184B	6	SDL-600-300	28
615.....	67	1680.....	17	2565.....	32	4080B	49, 51	9201.....	12	SDL-800-75	28
625.....	67	1682A.....	17	2566.....	32	5335B	20	9202.....	12	TL 130B.....	71
627.....	67	1685B	14	2567.....	32	5491B	61	9205.....	12	TL 30.....	68
630.....	67	1686A.....	17	2568.....	32	5492B	62	9206.....	12	TL 37.....	71
636.....	67	1687B	14	2569.....	32	8500.....	23,29	9801.....	21	TL 5A.....	68
710.....	67	1688B	14	2650A.....	58-59	8502.....	29	9802.....	21	TL-50B	71
715.....	67	1692.....	17	2652A.....	58	8510.....	29	9803.....	21	TL500B	71
720.....	67	1693.....	17	2703C	12	8512.....	29	9832.....	19	TLFG	70
725.....	67	1694.....	17	2704C	12	8514.....	29	9833.....	19	TLP5	68
731A.....	67	1696.....	16	2705B	12	8518.....	29	BA6010	45,46	TLPWR1	68
732A.....	67	1697.....	16	2706B	21	8520.....	29	BA6011	45,46	XLN10014	7
735.....	67	1698.....	16	2707B	21	8522.....	29	CAL73	67	XLN10014-GL.....	7
810C	39,43	1710A.....	17	2708B	21	8524.....	29	CC500	70	XLN15010	7
815.....	43	1715A.....	17	2709B	19	8526.....	29	CC510	70	XLN15010-GL.....	7
830C	39,43	1730A.....	17	2712.....	61,63	8540.....	23,29	CC545	68	XLN30052	7
844USB.....	66	1735A.....	17	2831E.....	19	8600.....	23,26,45	CP3	71	XLN30052-GL.....	7
866C	66	1737.....	13	2840	44	8601.....	26	CP62	68	XLN3640	7
867C	66	1739.....	16	2841	39,44	8602.....	26	CT2701	70	XLN3640-GL.....	7
875B	39,42	1747.....	13	2860A.....	67	8610.....	26	DP21	39	XLN60026	7
878B	39,42	1760A.....	18	3001.....	49,56	8612.....	26	DP31A.....	39,43	XLN60026-GL.....	7
879B	39,42	1761.....	18	3003.....	49,56	8614.....	26,27	DP52	39,43	XLN6024	7
880.....	42	1762.....	18	4001A.....	49	8616.....	26	FRA8000	45,47	XLN6024-GL.....	7
881.....	43	1785B	14	4003A.....	49,56	9103.....	13	MDL200	24-25	XLN8018	7
885.....	42	1786B	14	4005DDS.....	49,54	9104.....	13	MDL252.....	24-25	XLN8018-GL.....	7
886.....	42	1787B	14	4007B	49,54	9110.....	18	MDL302.....	24-25		
889B	39,41	1788.....	14	4010A.....	49,56	9111.....	18	MDL305.....	24-25		
890C	39,43	2120C	31,37	4011A.....	49,56	9115.....	10,45	MDL400.....	24-25		
891.....	41	2125C	31,37	4012A.....	49,56	9115-AT	10	MDL505.....	24-25		
894.....	40	2160C	31,37	4013B	49,54	9116.....	10	MDL600.....	24-25		
895.....	40	2190E.....	31,37	4014B	49,54	9117.....	10	PR100A.....	69		

Support & Service

At B&K Precision, we're committed to providing excellent product support and customer service to both current and future users of our products, and strive to continuously improve our operations. We're regularly upgrading our existing capabilities and services, and adding new methods of support to meet the changing needs of our valued customers.

Technical support

To help our customers determine quickly and efficiently which instruments best fit their application and budget, we provide comprehensive and growing resources on our website such as: data sheets, user manuals, high resolution product images, selection guides and tools, software, videos, application notes, product guides, and "where to buy" information. If you can't find the information you are looking for using our website, you can call us and talk to an experienced engineer with in-depth knowledge of our products who will be able to discuss your application and requirements.

If you need help with an instrument you've already purchased, we are here to assist you with product setup, usage or troubleshooting. You can find additional support by browsing our knowledge base or you can contact us directly via email or phone, which are answered in a timely manner by a qualified engineer.

Calibration and repair

Every new B&K Precision instrument comes standard with a 1, 2, or 3-year warranty against defects from the original date of purchase. Our warranties are valid worldwide, and we provide service and support through our global network of partner companies and dedicated service centers to guarantee your satisfaction.

The following calibration and repair options are currently available: NIST traceable calibration with or without data, warranty repair with a guaranteed turnaround time of 10 business days (excluding shipping time to/from B&K Precision, Yorba Linda, CA, USA), reasonably priced out-of-warranty instrument repair with fixed prices, and pre-paid calibration packages.

We make every attempt to support our customers even long after a product has been discontinued. Our goal is to service and repair B&K products up to 7 years after their obsolescence date, provided spare parts are still available. In many cases, we provide user manuals, calibration procedures, spare parts and schematics for selected discontinued products well beyond the 7-year period.

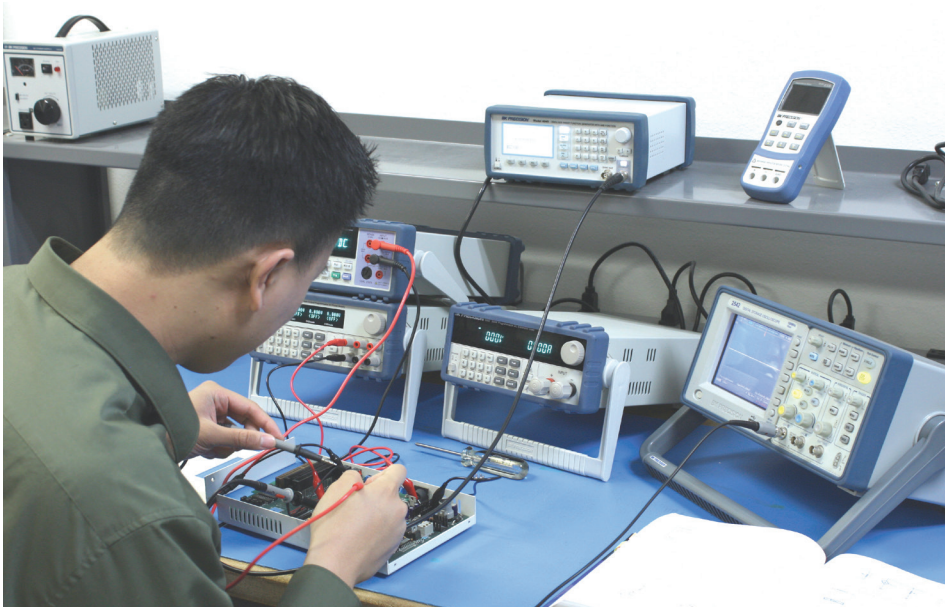

Visit our website for full support, service and calibration options.

Connect with us via Facebook, Twitter, YouTube or subscribe to our newsletter.



twitter™ YouTube™



22820 Savi Ranch Parkway, Yorba Linda, CA 92887

www.bkprecision.com

Copyright© B&K Precision Corporation. All rights reserved.
Other company and product names may be trademarks of their respective owners.

Specifications and other information in this catalog subject to change without notice.

