

BK PRECISION®

Model: 4063, 4064, 4065

Function/Arbitrary Waveform Generator

USER MANUAL



Safety Summary

The following safety precautions apply to both operating and maintenance personnel and must be followed during all phases of operation, service, and repair of this instrument.

WARNING

Before applying power to this instrument:

- Read and understand the safety and operational information in this manual.
- Apply all the listed safety precautions.
- Verify that the voltage selector at the line power cord input is set to the correct line voltage. Operating the instrument at an incorrect line voltage will void the warranty.
- Make all connections to the instrument before applying power.
- Do not operate the instrument in ways not specified by this manual or by B&K Precision.

Failure to comply with these precautions or with warnings elsewhere in this manual violates the safety standards of design, manufacture, and intended use of the instrument. B&K Precision assumes no liability for a customer's failure to comply with these requirements.

Category rating

The IEC 61010 standard defines safety category ratings that specify the amount of electrical energy available and the voltage impulses that may occur on electrical conductors associated with these category ratings. The category rating is a Roman numeral of I, II, III, or IV. This rating is also accompanied by a maximum voltage of the circuit to be tested, which defines the voltage impulses expected and required insulation clearances. These categories are:

Category I (CAT I): Measurement instruments whose measurement inputs are not intended to be connected to the mains supply. The voltages in the environment are typically derived from a limited-energy transformer or a battery.

Category II (CAT II): Measurement instruments whose measurement inputs are meant to be connected to the mains supply at a standard wall outlet or similar sources. Example measurement environments are portable tools and household appliances.

Category III (CAT III): Measurement instruments whose measurement inputs are meant to be connected to the mains installation of a building. Examples are measurements inside a building's circuit breaker panel or the wiring of permanently-installed motors.

Category IV (CAT IV): Measurement instruments whose measurement inputs are meant to be connected to the primary power entering a building or other outdoor wiring.

WARNING

Do not use this instrument in an electrical environment with a higher category rating than what is specified in this manual for this instrument.

WARNING

You must ensure that each accessory you use with this instrument has a category rating equal to or higher than the instrument's category rating to maintain the instrument's category rating. Failure to do so will lower the category rating of the measuring system.

Electrical Power

This instrument is intended to be powered from a CATEGORY II mains power environment. The mains power should be 120 V RMS or 240 V RMS. Use only the power cord supplied with the instrument and ensure it is appropriate for your country of use.

Ground the Instrument

WARNING

To minimize shock hazard, the instrument chassis and cabinet must be connected to an electrical safety ground. This instrument is grounded through the ground conductor of the supplied, three-conductor AC line power cable. The power cable must be plugged into an approved three-conductor electrical outlet. The power jack and mating plug of the power cable meet IEC safety standards.

WARNING

Do not alter or defeat the ground connection. Without the safety ground connection, all accessible conductive parts (including control knobs) may provide an electric shock. Failure to use a properly-grounded approved outlet and the recommended three-conductor AC line power cable may result in injury or death.

WARNING

Unless otherwise stated, a ground connection on the instrument's front or rear panel is for a reference of potential only and is not to be used as a safety ground.

Do not operate in an explosive or flammable atmosphere

WARNING

Do not operate the instrument in the presence of flammable gases or vapors, fumes, or finely-divided particulates.

WARNING

The instrument is designed to be used in office-type indoor environments. Do not operate the instrument

- In the presence of noxious, corrosive, or flammable fumes, gases, vapors, chemicals, or finely-divided particulates.
- In relative humidity conditions outside the instrument's specifications.
- In environments where there is a danger of any liquid being spilled on the instrument or where any liquid can condense on the instrument.
- In air temperatures exceeding the specified operating temperatures.
- In atmospheric pressures outside the specified altitude limits or where the surrounding gas is not air.
- In environments with restricted cooling air flow, even if the air temperatures are within specifications.
- In direct sunlight.

CAUTION

This instrument is intended to be used in an indoor pollution degree 2 environment. The operating temperature range is 0 °C to 40 °C and the operating humidity is $\leq 90\%$ relative humidity at $< 35\text{ °C}$ and $\leq 60\%$ relative humidity at $35\text{ °C} - 40\text{ °C}$, with no condensation allowed.

Measurements made by this instrument may be outside specifications if the instrument is used in non-office-type environments. Such environments may include rapid temperature or humidity changes, sunlight, vibration and/or mechanical shocks, acoustic noise, electrical noise, strong electric fields, or strong magnetic fields.

Do not operate instrument if damaged

WARNING

If the instrument is damaged, appears to be damaged, or if any liquid, chemical, or other material gets on or inside the instrument, remove the instrument's power cord, remove the instrument from service, label it as not to be operated, and return the instrument to B&K Precision for repair. Notify B&K Precision of the nature of any contamination of the instrument.

Clean the instrument only as instructed

WARNING

Do not clean the instrument, its switches, or its terminals with contact cleaners, abrasives, lubricants, solvents, acids/bases, or other such chemicals. Clean the instrument only with a clean dry lint-free cloth or as instructed in this manual.

Not for critical applications

⚠ WARNING

This instrument is not authorized for use in contact with the human body or for use as a component in a life-support device or system.

Do not touch live circuits

⚠ WARNING

Instrument covers must not be removed by operating personnel. Component replacement and internal adjustments must be made by qualified service-trained maintenance personnel who are aware of the hazards involved when the instrument's covers and shields are removed. Under certain conditions, even with the power cord removed, dangerous voltages may exist when the covers are removed. To avoid injuries, always disconnect the power cord from the instrument, disconnect all other connections (for example, test leads, computer interface cables, etc.), discharge all circuits, and verify there are no hazardous voltages present on any conductors by measurements with a properly-operating voltage-sensing device before touching any internal parts. Verify the voltage-sensing device is working properly before and after making the measurements by testing with known-operating voltage sources and test for both DC and AC voltages. Do not attempt any service or adjustment unless another person capable of rendering first aid and resuscitation is present. Do not insert any object into an instrument's ventilation openings or other openings.

⚠ WARNING

Hazardous voltages may be present in unexpected locations in circuitry being tested when a fault condition in the circuit exists.

Servicing

⚠ CAUTION

Do not substitute parts that are not approved by B&K Precision or modify this instrument. Return the instrument to B&K Precision for service and repair to ensure that safety and performance features are maintained.

Cooling fans

CAUTION

This instrument contains one or more cooling fans. For continued safe operation of the instrument, the air inlet and exhaust openings for these fans must not be blocked nor must accumulated dust or other debris be allowed to reduce air flow. Maintain at least 25 mm clearance around the sides of the instrument that contain air inlet and exhaust ports. If mounted in a rack, position power devices in the rack above the instrument to minimize instrument heating while rack mounted. Do not continue to operate the instrument if you cannot verify the fan is operating (note some fans may have intermittent duty cycles). Do not insert any object into the fan's inlet or outlet.

For continued safe use of the instrument

- Do not place heavy objects on the instrument.
- Do not obstruct cooling air flow to the instrument.
- Do not place a hot soldering iron on the instrument.
- Do not pull the instrument with the power cord, connected probe, or connected test lead.
- Do not move the instrument when a probe is connected to a circuit being tested.

Compliance Statements

Disposal of Old Electrical & Electronic Equipment (Applicable in the European Union and other European countries with separate collection systems)

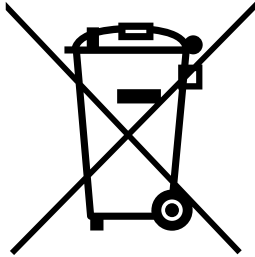

This product is subject to Directive 2002/96/EC of the European Parliament and the Council of the European Union on waste electrical and electronic equipment (WEEE), and in jurisdictions adopting that Directive, is marked as being put on the market after August 13, 2005, and should not be disposed of as unsorted municipal waste. Please utilize your local WEEE collection facilities in the disposition of this product and otherwise observe all applicable requirements.

CE Declaration of Conformity

This instrument meets the requirements of 2006/95/EC Low Voltage Directive and 2004/108/EC Electromagnetic Compatibility Directive with the following standards.











Low Voltage Directive

- EN61010-1: 2001

EMC Directive

- EN 61000-3-2: 2006
- EN 61000-3-3: 1995+A1: 2001+A2: 2005
- EN 61000-4-2 / -3 / -4 / -5 / -6 / -11
- EN 61326-1: 2006

Safety Symbols

	Refer to the user manual for warning information to avoid hazard or personal injury and prevent damage to instrument.
	Electric Shock hazard
	Alternating current (AC)
	Chassis (earth ground) symbol.
	Ground terminal
	On (Power). This is the In position of the power switch when instrument is ON.
	Off (Power). This is the Out position of the power switch when instrument is OFF.
	Power Switch (On/Off). This is the power switch located in front of the instrument.
	CAUTION indicates a hazardous situation which, if not avoided, will result in minor or moderate injury
	WARNING indicates a hazardous situation which, if not avoided, could result in death or serious injury
	DANGER indicates a hazardous situation which, if not avoided, will result in death or serious injury.

Contents

Safety Summary	i
Compliance Statements	vi
Safety Symbols	viii
1 General Information	1
1.1 Product Overview	1
1.2 Package Contents	1
1.3 Front Panel Overview	2
<i>Front Panel Description</i>	2
1.4 Rear Panel Overview	3
<i>Rear Panel Description</i>	3
1.5 Display Overview	4
<i>Display Description</i>	4
2 Getting Started	5
2.1 Input Power Requirements.....	5
<i>Input Power</i>	5
2.2 Output Connections	5
<i>Impedance Matching</i>	6
2.3 Preliminary Check.....	6
<i>Check Model and Firmware Version</i>	8
<i>Output Check</i>	8
3 Front Panel Operation	9
3.1 Menu Options.....	9
3.2 Selecting a Channel	12
3.3 Configure Waveform Output	12
<i>Configure Waveform Shape</i>	12
<i>Configure Frequency</i>	14
<i>Configure Amplitude</i>	14
<i>Configure DC Offset</i>	15
<i>Configure Phase</i>	16
<i>Configure Duty Cycle and Symmetry</i>	17
<i>Configure Pulse Waveform</i>	19
<i>Configure Noise Waveform</i>	20
<i>Configure DC Output Waveform</i>	22

	<i>Configure Arbitrary Waveform</i>	23
3.4	Configure Modulation Output	26
	<i>AM Modulation</i>	26
	<i>FM Modulation</i>	28
	<i>PM Modulation</i>	29
	<i>FSK Modulation</i>	31
	<i>ASK Modulation</i>	32
	<i>DSB-AM</i>	33
	<i>PWM Modulation (Pulse Only)</i>	34
3.5	Configure Sweep Output	35
3.6	Configure Burst	38
3.7	Utility Functions	42
	<i>Remote Interface</i>	42
	<i>Sync Output</i>	44
	<i>Frequency Counter</i>	45
	<i>System Settings</i>	47
	<i>Store and Recall</i>	51
	<i>Self Test and Adjustment</i>	56
	<i>Check Instrument Information</i>	57
	<i>Updating Firmware</i>	57
	<i>Output Configurations</i>	57
	<i>Duplicate Channel Parameters (CHCopy)</i>	59
3.8	Help System	59
4	Troubleshooting Guide	60
5	Specifications	61
	SERVICE INFORMATION	65
	LIMITED THREE-YEAR WARRANTY	66

1 General Information

1.1 Product Overview

The B&K Precision 4060 series are dual channel function / arbitrary waveform generators, capable of generating up to 160 MHz sine wave (model 4065). They have a large and informative easy-to-read color display, user-friendly controls, and a numeric keypad which allows users to easily configure waveform properties. In addition to sine, square, triangle, and pulse waveforms, they feature non-volatile built-in memory to create, store, and recall arbitrary waveforms up to 512,000 points with 14-bit vertical resolution. A standard USB interface on the rear panel allows users to easily interface with application software to create and load arbitrary waveforms into the instrument and also contains a front panel USB port to easily save and load instrument settings and waveforms.

Features:

- 14-bit, 500 MSa/s, 512k point arbitrary waveform generator
- Generate sine waves from 1 μ Hz up to 160 MHz (Model 4065)
- Large 4.3-inch TFT-LCD color display
- AM/DSB-AM/ASK/FM/FSK/PM/PWM modulation functions
- 36 built-in predefined arbitrary waveforms
- Store/recall up to 10 instrument settings
- USB host/device interface

1.2 Package Contents

Please inspect the instrument mechanically and electrically upon receiving it. Unpack all items from the shipping carton, and check for any obvious signs of physical damage that may have occurred during transportation. Report any damage to the shipping agent immediately. Save the original packing carton for possible future reshipment. Every instrument is shipped with the following contents:

- **1 x 4060 series function/arbitrary waveform generator**
- **1 x Getting started manual (printed)**
- **1 x Full instruction manual on CD**
- **1 x AC power cord**
- **1 x USB type A to Type B cable**
- **1 x Certificate of calibration**

Verify that all items above are included in the shipping container. If anything is missing, please contact B&K Precision.

An optional USB to GPIB adapter model AK40G is also available for connecting the instrument to a GPIB bus controller.

1.3 Front Panel Overview

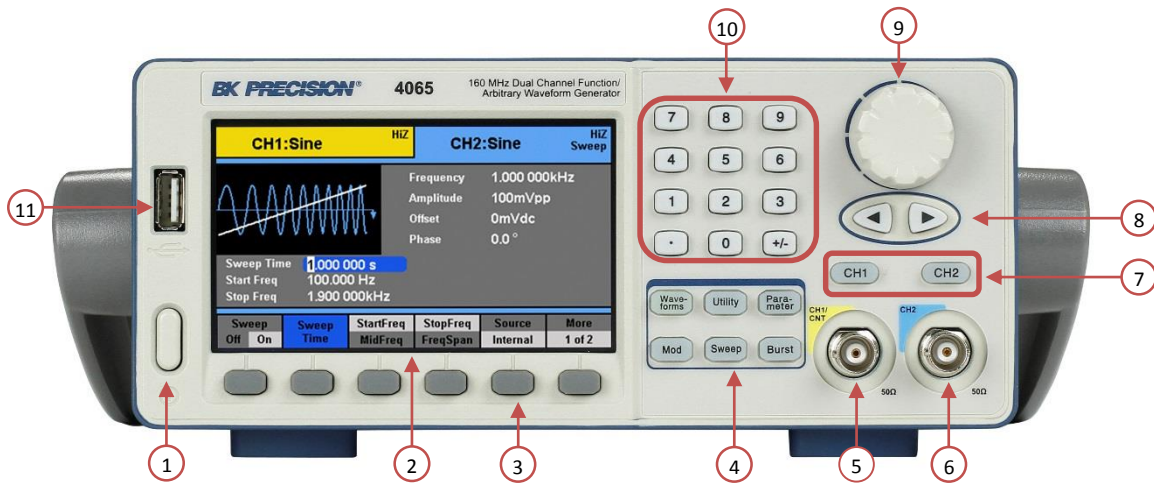

Front Panel Description

- ① Power On/Off switch
- ② TFT LCD color display
- ③ Menu function keys
- ④ Waveforms/Utility/Parameter/Modulation/Sweep/Burst menu buttons
- ⑤ Channel 1 output BNC/Counter input
- ⑥ Channel 2 output BNC
- ⑦ Channel 1 and 2 select buttons
- ⑧ Arrow keys
- ⑨ Rotary dial knob
- ⑩ Numeric keypad

- ⑪ **USB host port/*USB-to-GPIB adapter interface**
Accepts USB flash drive to save/recall instrument settings and waveforms.
*This port can be used for connecting the USB-to-GPIB adapter (AK40G) accessory. It can also be used for connecting an external USB flash drive.

1.4 Rear Panel Overview



Rear Panel Description

①	External Trigger/Gate/FSK/Burst BNC connector
②	10MHz Out BNC connector
③	USB interface
④	AC input receptacle
⑤	Chassis ground
⑥	10MHz In BNC connector
⑦	Sync Output BNC
⑧	Modulation Input BNC

1.5 Display Overview

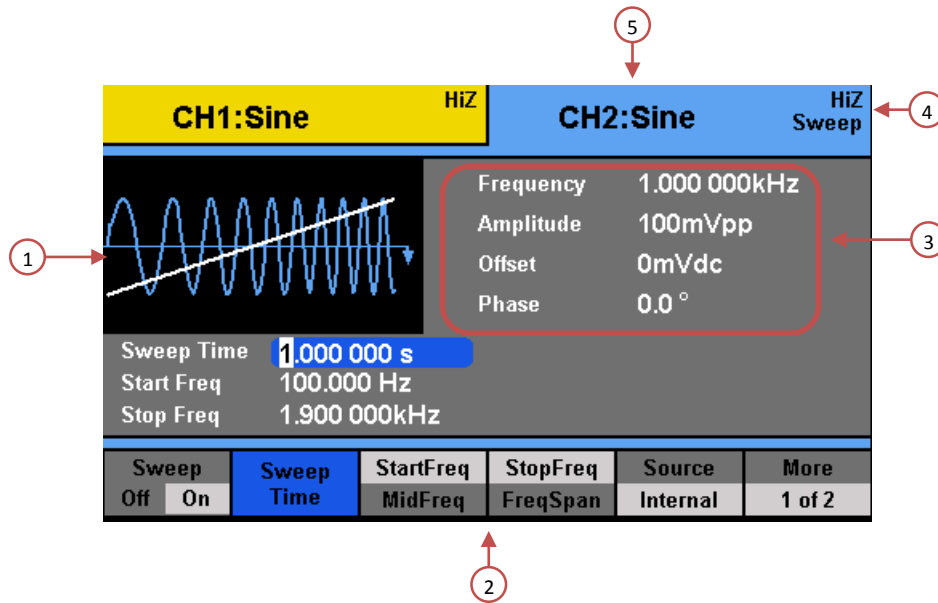

Display Description

①	Waveform display
②	Menu options
③	Waveform parameters display
④	Waveform mode and output impedance indicator
⑤	Selected channel indicator

2 Getting Started

Before connecting and powering up the instrument, please review and go through the instructions in this chapter.

2.1 Input Power Requirements

Input Power

The supply has a universal AC input that accepts line voltage and frequency input within:

100 – 240 V (+/- 10%), 50 – 60 Hz (+/- 5%)

100 – 127 V, 45 – 440 Hz

Before connecting to an AC outlet or external power source, be sure that the power switch is in the OFF position and verify that the AC power cord, including the extension line, is compatible with the rated voltage/current and that there is sufficient circuit capacity for the power supply. Once verified, connect the cable firmly.

⚠ WARNING

The included AC power cord is safety certified for this instrument operating in rated range. To change a cable or add an extension cable, be sure that it can meet the required power ratings for this instrument. Any misuse with wrong or unsafe cables will void the warranty.

2.2 Output Connections

The waveform generator output circuits operate as a 50 Ω voltage source working into a 50 Ω load. At higher frequencies, a non-terminated or improperly terminated output may cause aberrations on the output waveform. In addition, loads with an impedance less than 50 Ω will reduce the waveform amplitude, while loads with an impedance greater than 50 Ω will increase waveform amplitude.

Excessive distortion or aberrations caused by improper termination are less noticeable at lower frequencies, especially with sine and triangle waveforms. To ensure waveform integrity, follow these precautions:

1. Use good quality 50 Ω coaxial cable and connectors.
2. Make all connections tight and as short as possible.
3. Use good quality attenuators, if it is necessary to reduce waveform amplitudes applied to sensitive circuits.
4. Use termination or impedance-matching devices to avoid reflections.
5. Ensure that attenuators and terminations have adequate power handling capabilities.

If there is a DC voltage across the output load, use a coupling capacitor in series with the load. The time constant of the coupling capacitor and load must be long enough to maintain pulse flatness.

Impedance Matching

If the waveform generator is driving a high impedance, such as a 1 M Ω input impedance (paralleled by a stated capacitance) of an oscilloscope vertical input, connect the transmission line to a 50 Ω attenuator, a 50 Ω termination and to the oscilloscope input. The attenuator isolates the input capacitance of the device and terminates the waveform generator properly.

2.3 Preliminary Check

Complete the following steps to verify that the generator is ready for use.

1. Verify AC Input Voltage

Verify and check to make sure proper AC voltages are available to power the instrument. The AC voltage range must meet the acceptable specification as explained in section 2.1.

2. Connect Power

Connect AC power cord to the AC receptacle in the rear panel and press the power switch to the ON position to turn ON the instrument. The instrument will have a boot screen while loading, after which the main screen will be displayed.

3. Self Test

Press **Utility**, select **More 1 of 2** from the menu to enter the second menu page, and select **Test/Cal** option. Then, select **SelfTest** option. The instrument has 3 self-test options to test the screen, keys, and the LED back lights of the function, menu, and channel keys.

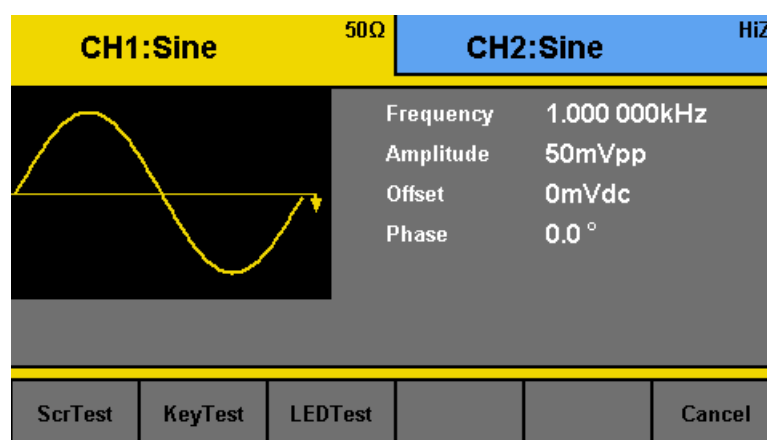

ScrTest Select this option to do a screen test. The screen will turn into a solid color background.

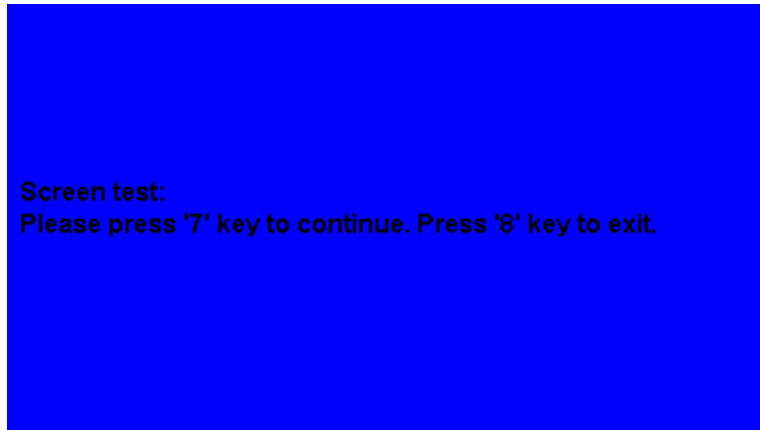

Press **7** to toggle through red, green, and blue colors. This test checks for dead pixels and color consistencies of the TFT LCD display. Press **8** to exit the test.

KeyTest Select this option to do a key test. The screen will display a silhouette of buttons that represent the front panel buttons.

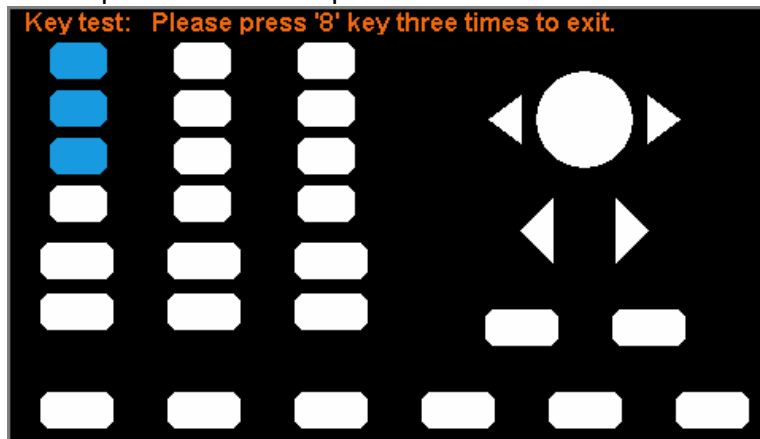

Press any of the front panel buttons and its corresponding button in the silhouette will turn green. This tests the key press response. If any of the buttons do not change colors on the silhouette when pressed, there may be something faulty with the key. Press **8** three times to exit the test.

LEDTest Select this option to test the function, menu, and channel output buttons' backlight.

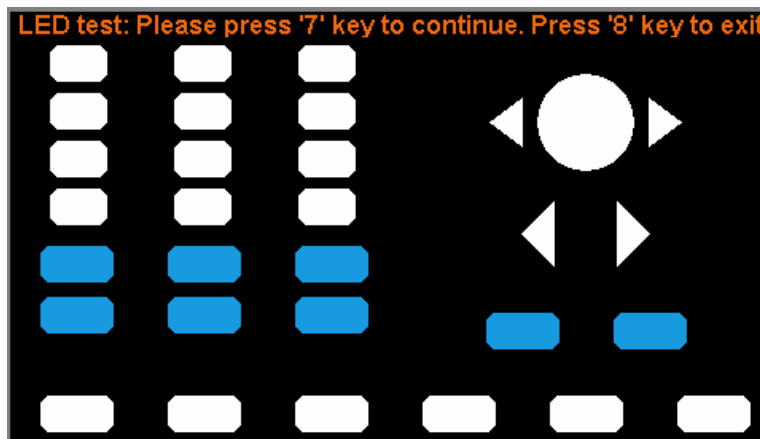

Like the key test, the screen will display a silhouette of buttons that represent the front panel buttons. Press **7** to begin the test. This test will

start with the **Waveforms** button, which should light up. Its corresponding button in the silhouette should also turn blue. Continue to press **7** to toggle through all the buttons with backlights available. At the end of the test, all function, menu, and channel output buttons will light up, and all of their corresponding buttons in the silhouette on the display will turn blue. Press **8** to exit the test.

4. Self Adjust

This option runs an internal self adjustment procedure that will check and adjust the instrument to specification. Use this option only if the instrument is suspected to be out of calibration.

Press **Utility**, select **More 1 of 2** from the menu to enter the second menu page, and select **Test/Cal** option. Make sure nothing is connected to the instrument. Then, select **SelfAdjust** option. The instrument will run the procedure internally, and a progress bar will be displayed in the waveform information area. When finished, it will show 100% on the progress bar and prompt you to press any function key to continue. Follow the prompt to return to the main display.

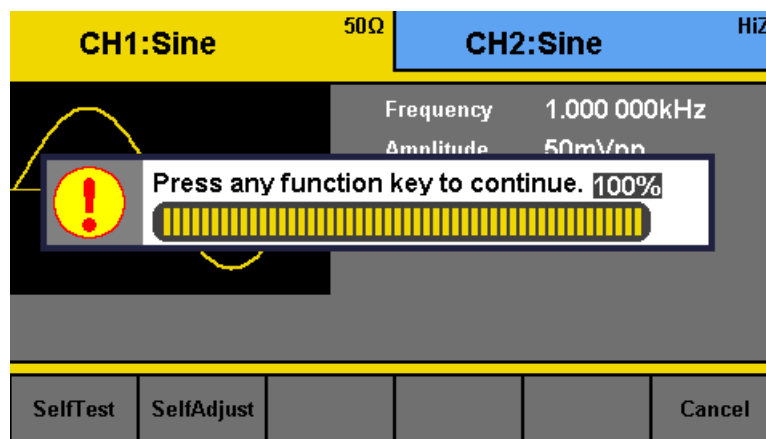

Check Model and Firmware Version

The model and firmware version can be verified from within the menu system.

Press **Utility**, select **More 1 of 2** from the menu to enter the second menu page, and select **EditInfo** option. The software/firmware version, hardware version, model, and serial number will be displayed. Press any function key to exit.

Output Check

Follow the steps below to do a quick check of the settings and waveform output.

1. Turn on the instrument and set the instrument to default settings. To set to default, press **Utility**, press **More 1 of 2** to go to page 2, select **System** from the menu, and select **Set to Default**. The instrument will set both channels with the following parameters:

Waveform Shape: **Sine**
 Frequency: **1.000000 kHz**
 Amplitude: **100 mVpp**
 Offset: **0.0 mVdc**
 Phase: **0.0 °**
 Output Impedance: **Hi-Z**

2. Connect the BNC output of CH1 (yellow) into an oscilloscope.
3. Press the **Output** button on top of CH1 output BNC to turn on the output and observe a sine wave with the parameters above.
4. Press the **Freq** or **Period** option in the menu and use the rotary knob or the numeric keypad to change frequency. Observe the changes on the oscilloscope display.
5. Press the **Ampl** option in the menu and use the rotary knob or the numeric keypad to change the amplitude. Observe the changes on the oscilloscope display.
6. Press the **Offset** option in the menu and use the rotary knob or the numeric keypad to change the DC offset. With the oscilloscope set for DC coupling, observe the changes on the display.
7. Now, connect the BNC output of CH2 (blue) into an oscilloscope and follow steps 3 to 6 to check its output.

3 Front Panel Operation

3.1 Menu Options

All settings and parameters can be configured from the menu system of the instrument. The menu options that are channel specific are the same for both channel 1 and channel 2. Use the and output keys to toggle the channel selection.

Some many options are grouped in pairs and can be selected by toggling their corresponding menu function keys. For example:

Frequency	Amplitude	Offset	Phase
Period	HighLevel	LowLevel	
Function key will toggle selection between frequency or period .	Function key will toggle selection between amplitude or HighLevel .	Function key will toggle selection between DC offset or LowLevel .	Function key will select phase .

The menu system is organized as follows:

Waveforms	Parameter	
Sine	Frequency/Period	Configures the frequency or period of the waveform.
	Amplitude/HighLevel	Configures the amplitude or the high level of the waveform.
	Offset/LowLevel	Configures the DC offset or the low level of the waveform.
	Phase	Configures the phase relative to the other channel.
Square	Frequency/Period	Configures the frequency or period of the waveform.
	Amplitude/HighLevel	Configures the amplitude or the high level of the waveform.
	Offset/LowLevel	Configures the DC offset or the low level of the waveform.
	Phase	Configures the phase relative to the other channel.
	Duty	Configures the duty cycle of the waveform.
Ramp	Frequency/Period	Configures the frequency or period of the waveform.
	Amplitude/HighLevel	Configures the amplitude or the high level of the waveform.
	Offset/LowLevel	Configures the DC offset or the low level of the waveform.
	Phase	Configures the phase relative to the other channel.
	Symmetry	Configures the symmetry of the waveform.
Pulse	Frequency/Period	Configures the frequency or period of the waveform.
	Amplitude/HighLevel	Configures the amplitude or the high level of the waveform.
	Offset/LowLevel	Configures the DC offset or the low level of the waveform.
	Width/Duty	Configures the pulse width or the duty cycle of the pulse.
	Rise/Fall	Configures the rise or fall time of the pulse.
	Delay	Configures the delay of the pulse waveform.
Noise	Stdev	Configures the standard deviation of the noise waveform.
	Mean	Configures the mean value of the noise waveform.
DC	DC Offset	Configures the DC offset of the DC waveform.
Arb	Frequency/Period	Configures the frequency or period of the waveform.
	Amplitude/HighLevel	Configures the amplitude or the high level of the waveform.
	Offset/LowLevel	Configures the DC offset or the low level of the waveform.
	Phase	Configures the phase relative to the other channel.
	Built-In	Access selectable built-in waveforms for output.
	Stored Wforms	Access arbitrary waveforms stored in internal memory.
Mod		
	Modulate	Toggles the modulation ON/OFF
	Type	Configures the type of modulation. Configures parameters for AM, FM, PM, ASK, FSK, DSB-AM, or PWM modulation.
	Shape	Configures the modulating waveform shape.
	Source	Selects modulating source.

Sweep	
Sweep Time	Configures the sweep time for sweep output.
StartFreq/MidFreq	Configures the sweep start frequency or the center frequency.
StopFreq/FreqSpan	Configures the sweep stop frequency or the frequency span of the sweep output.
Source	Selects the sweep source.
Trig Out	Internal source: Selects to output a trigger signal at the start of a sweep operation.
Edge	External source: Selects to use rising or falling edge from an external trigger for sweep operation.
Type	Selects between linear or logarithmic sweep operations.
Direction	Selects the sweep direction.
Trig	Manually triggers the sweep operation if the source is set to manual.
Burst	
Ncycle/Gated	Selects to burst by number of cycles or selects for external gated burst.
Cycles/Infinite	Configures number of cycles for burst or infinite burst (external source only).
Start Phase	Configures the start phase of the burst output.
Burst Period	Configures the burst period.
Delay	Configures the delay of each burst.
Trig Out	Configures signal triggering on rising or falling edge.
Source	Configures the trigger source.
Utility	
Interface	Configure remote interface.
Sync	Configure synchronization output with respect to either channel 1 or 2.
Counter	Selects built-in counter function.
System	Access to system settings.
Store/Recall	Access to stored files in memory.
Test/Cal	Built-in self-test and adjustment options.
EditInfo	Shows information about the generator.
Update	For firmware updates.
Help	Help menu.
CH1 / CH2	
Output	Enable/Disable the output for the selected channel
Load	Select output impedance for the selected channel
Polarity	Select to toggle between normal and inverted output.
EqPhase	Equates opposite channel's phase to current channel's phase.
CHCopy	Copy channel settings between channels.

3.2 Selecting a Channel

The 4060 series function/arbitrary waveform generators have dual channel outputs. They can be operated independently or in sync with each other. To select between channel 1 and 2 and view/change their parameters, toggle the and keys.

When **Channel 1** is selected, the display will look like the following:

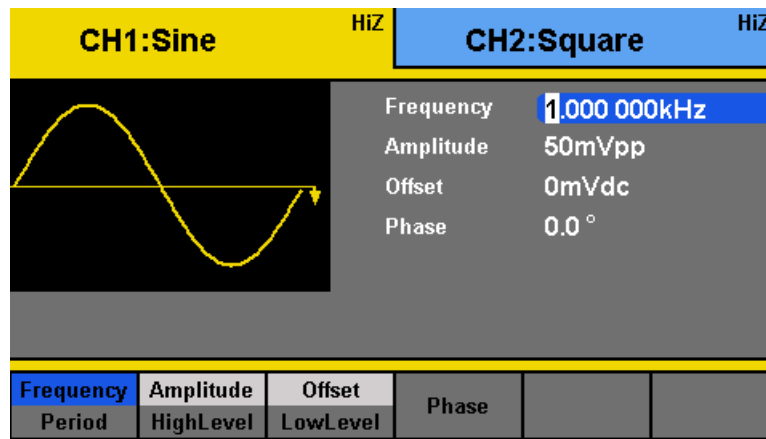

When **Channel 2** is selected, the display will look like the following:

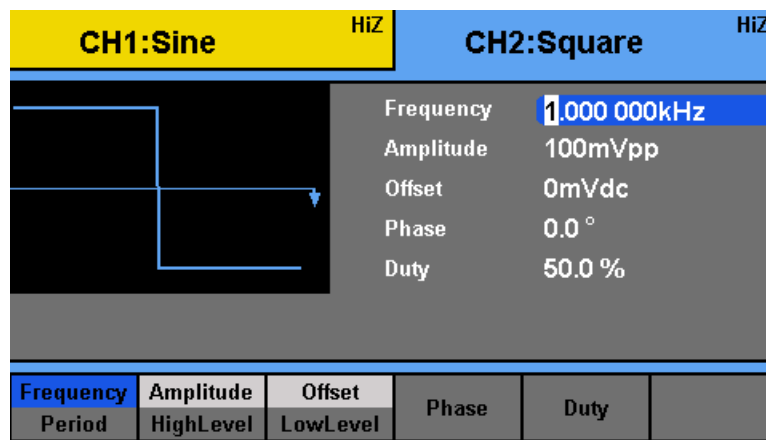

3.3 Configure Waveform Output

Configure Waveform Shape

The instrument can generate many standard as well as arbitrary waveforms. There is a dedicated waveform key on the front panel that will allow the user to select between different waveform shapes to output. Below is a table of the corresponding waveforms that the 4060 series can generate.

Waveforms
Sine
Square
Ramp
Pulse
Noise
DC
Arbitrary

After the waveform selection, menu options relevant for that waveform shape will be shown on the bottom of the display. Below illustrates the screenshots shown when each of the waveform types is selected.

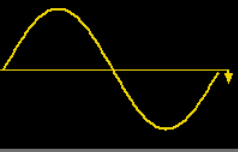
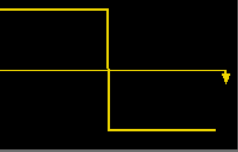
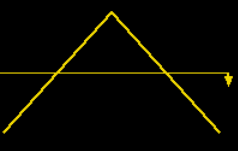
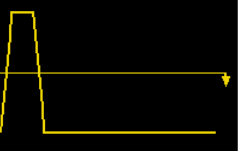
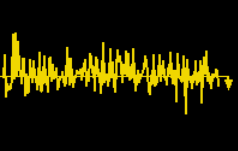
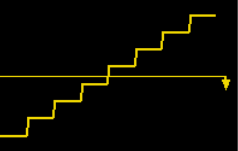
<p style="text-align: center;">Sine Waveform</p> <p>CH1:Sine HiZ CH2:Square HiZ</p>  <p>Frequency: 1.000 000kHz Amplitude: 50mVpp Offset: 0mVdc Phase: 0.0 °</p> <table border="1" style="width: 100%; text-align: center;"> <tr> <td>Frequency</td> <td>Amplitude</td> <td>Offset</td> <td>Phase</td> <td></td> <td></td> </tr> <tr> <td>Period</td> <td>HighLevel</td> <td>LowLevel</td> <td></td> <td></td> <td></td> </tr> </table>	Frequency	Amplitude	Offset	Phase			Period	HighLevel	LowLevel				<p style="text-align: center;">Square Waveform</p> <p>CH1:Square HiZ CH2:Square HiZ</p>  <p>Frequency: 1.000 000kHz Amplitude: 50mVpp Offset: 0mVdc Phase: 0.0 ° Duty: 50.0 %</p> <table border="1" style="width: 100%; text-align: center;"> <tr> <td>Frequency</td> <td>Amplitude</td> <td>Offset</td> <td>Phase</td> <td>Duty</td> <td></td> </tr> <tr> <td>Period</td> <td>HighLevel</td> <td>LowLevel</td> <td></td> <td></td> <td></td> </tr> </table>	Frequency	Amplitude	Offset	Phase	Duty		Period	HighLevel	LowLevel			
Frequency	Amplitude	Offset	Phase																						
Period	HighLevel	LowLevel																							
Frequency	Amplitude	Offset	Phase	Duty																					
Period	HighLevel	LowLevel																							
<p style="text-align: center;">Ramp Waveform</p> <p>CH1:Ramp 50Ω CH2:Sine HiZ</p>  <p>Frequency: 1.000 000kHz Amplitude: 100mVpp Offset: 0mVdc Phase: 0.0 ° Symmetry: 50.0 %</p> <table border="1" style="width: 100%; text-align: center;"> <tr> <td>Frequency</td> <td>Amplitude</td> <td>Offset</td> <td>Phase</td> <td>Symmetry</td> <td></td> </tr> <tr> <td>Period</td> <td>HighLevel</td> <td>LowLevel</td> <td></td> <td></td> <td></td> </tr> </table>	Frequency	Amplitude	Offset	Phase	Symmetry		Period	HighLevel	LowLevel				<p style="text-align: center;">Pulse Waveform</p> <p>CH1:Pulse 50Ω CH2:Sine HiZ</p>  <p>Frequency: 1.000 000kHz Amplitude: 100mVpp Offset: 0mVdc Pulse Width: 200.000us Rise Edge: 6.0ns Delay: 0.0ns</p> <table border="1" style="width: 100%; text-align: center;"> <tr> <td>Frequency</td> <td>Amplitude</td> <td>Offset</td> <td>Width</td> <td>Rise</td> <td>Delay</td> </tr> <tr> <td>Period</td> <td>HighLevel</td> <td>LowLevel</td> <td>Duty</td> <td>Fall</td> <td></td> </tr> </table>	Frequency	Amplitude	Offset	Width	Rise	Delay	Period	HighLevel	LowLevel	Duty	Fall	
Frequency	Amplitude	Offset	Phase	Symmetry																					
Period	HighLevel	LowLevel																							
Frequency	Amplitude	Offset	Width	Rise	Delay																				
Period	HighLevel	LowLevel	Duty	Fall																					
<p style="text-align: center;">Noise Waveform</p> <p>CH1:N oise 50Ω CH2:Sine HiZ</p>  <p>Stdev: 8mV Mean: 0mV</p> <table border="1" style="width: 100%; text-align: center;"> <tr> <td>Stdev</td> <td>Mean</td> <td></td> <td></td> <td></td> <td></td> </tr> </table>	Stdev	Mean					<p style="text-align: center;">Arbitrary Waveform</p> <p>CH1:Arb 50Ω CH2:Sine HiZ</p>  <p>Frequency: 1.000 000kHz Amplitude: 100mVpp Offset: 0mVdc Phase: 0.0 °</p> <table border="1" style="width: 100%; text-align: center;"> <tr> <td>Frequency</td> <td>Amplitude</td> <td>Offset</td> <td>Phase</td> <td>Built-in</td> <td>Stored Wforms</td> </tr> <tr> <td>Period</td> <td>HighLevel</td> <td>LowLevel</td> <td></td> <td></td> <td></td> </tr> </table>	Frequency	Amplitude	Offset	Phase	Built-in	Stored Wforms	Period	HighLevel	LowLevel									
Stdev	Mean																								
Frequency	Amplitude	Offset	Phase	Built-in	Stored Wforms																				
Period	HighLevel	LowLevel																							

Configure Frequency

Note: This section does not apply for noise or DC waveform.

Follow the steps below to configure the frequency or period of the output. The adjustable frequency range is different for each model and for each type of waveforms. See the specification section for the adjustable ranges.

1. After selecting the waveform shape, there will be a **Frequency/Period** menu option. Press the corresponding menu function key to toggle between selecting frequency or the period to adjust.
2. The cursor position will now highlight the first digit of the frequency parameter display.
3. Use the rotary knob or the numeric keypad to change the frequency. If numeric keypad is used, the following screen will be displayed:

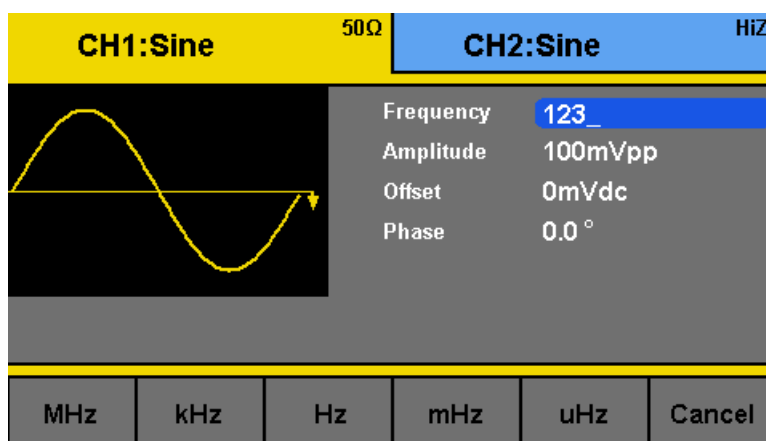

4. After entering the numeric value, use the menu function keys to select the unit to apply for the frequency setting. Available units are: **MHz**, **kHz**, **Hz**, **mHz**, and **uHz**.

Configure Amplitude

Note: This section does not apply for noise or DC waveform.

Follow the steps below to configure the amplitude of the output. The adjustable amplitude range for **Channel 1** and **Channel 2** are **1 mVpp – 10 Vpp into 50 Ω**, or **2 mVpp – 20 Vpp into HighZ**.

1. From the menu, select **Amplitude**.
2. The cursor position will now highlight the first digit of the amplitude parameter display.
3. Use the rotary knob or the numeric keypad to change the amplitude. If numeric keypad is used, the following screen will be displayed:

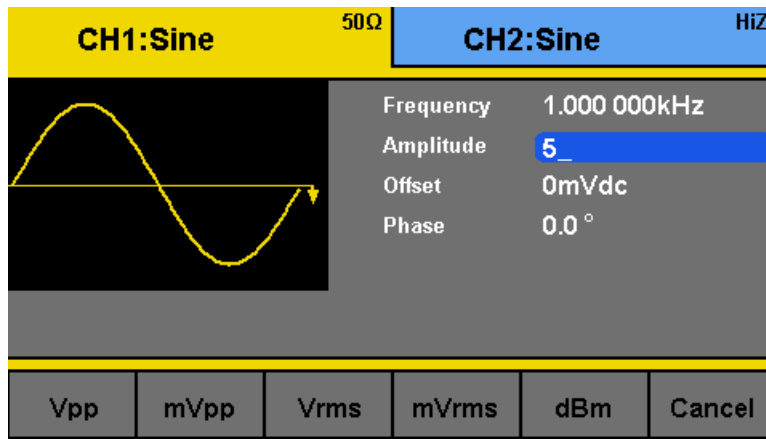

- After entering the numeric value, use the menu function keys to select the unit to apply for the amplitude setting. Available units are: **Vpp**, **mVpp**, **Vrms**, **mVrms**, and **dBm** (only available with 50 Ω output impedance).
Note: Only using the numeric keypad will allow for changing the units from V to Vrms, mVrms, or dBm.

User-Defined High and Low Level

The user has the option to adjust the high and low level of the waveform. To do this, toggle the menu function key to select **HighLevel** for high level or **LowLevel** for low level.

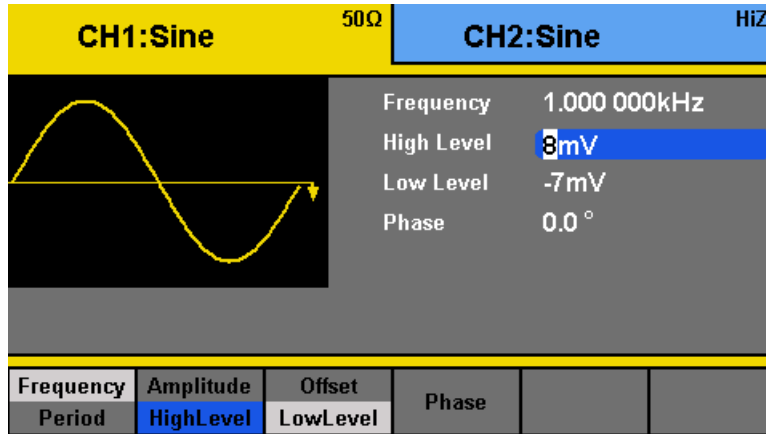

Note: DC offset settings will be automatically adjusted if the high and low levels reflect a DC offset.

Configure DC Offset

Note: This section does not apply for noise waveform.

Follow the steps below to configure the DC offset of the output.

1. From the menu, select **Offset**.
2. The cursor position will now highlight the first digit of the offset parameter display.
3. Use the rotary knob or the numeric keypad to change the offset. If numeric keypad is used, the following screen will be displayed:

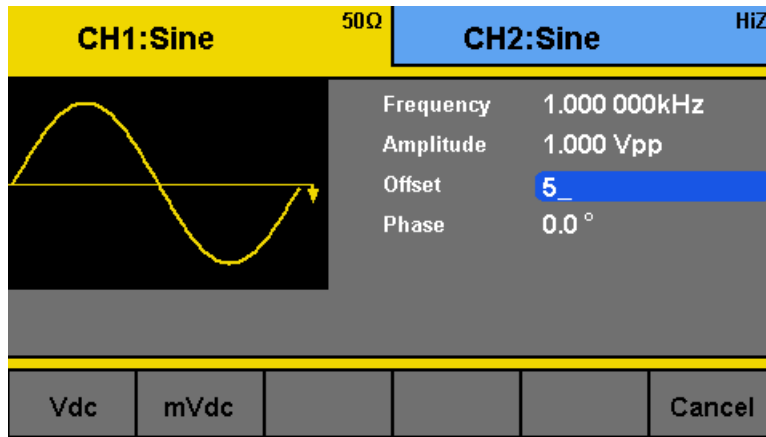

4. After entering the numeric value, use the menu function keys to select the unit to apply for the offset setting. Available units are: **Vdc** and **mVdc**.

Configure Phase

Note: This section does not apply for pulse, noise, or waveforms.

Follow the steps below to configure the phase of the output.

1. From the menu, select **Phase**.
2. The cursor position will now highlight the first digit of the phase parameter display.
3. Use the rotary knob or the numeric keypad to change the phase. If numeric keypad is used, the following screen will be displayed:

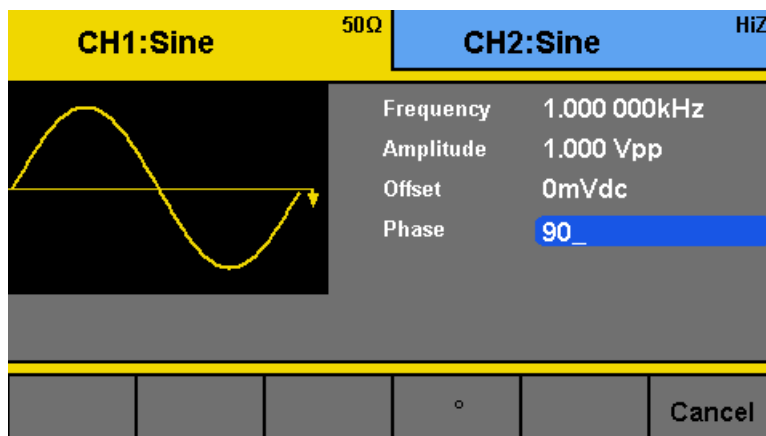

After entering the numeric value, use the menu function keys to select the degree (°) unit to apply for the phase setting.

Configure Duty Cycle and Symmetry

Note: This section does not apply for sine, noise, DC, or arbitrary waveforms.

Duty Cycle

Note: For square and pulse waveforms only.

Follow the steps below to configure the duty cycle of a square waveform.

1. Set the instrument for square or pulse wave output.
2. From the parameter menu, select **Duty (toggle Width/Duty for pulse)**.
3. The cursor position will now highlight the first digit of the duty parameter display.

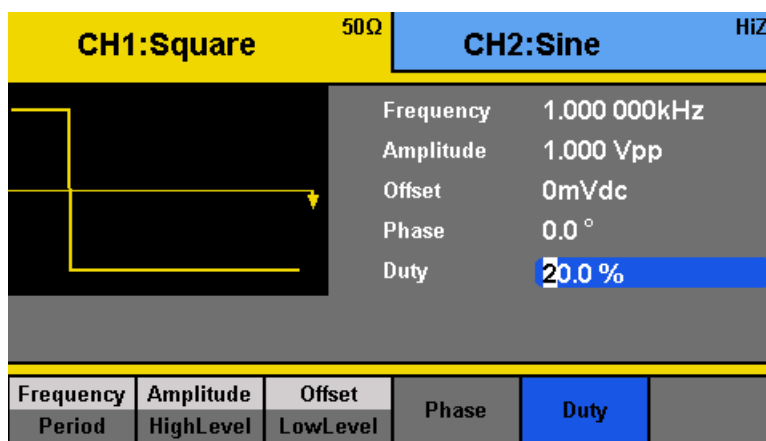

4. Use the rotary knob or the numeric keypad to change the duty cycle. If numeric keypad is used, the following screen will be displayed:

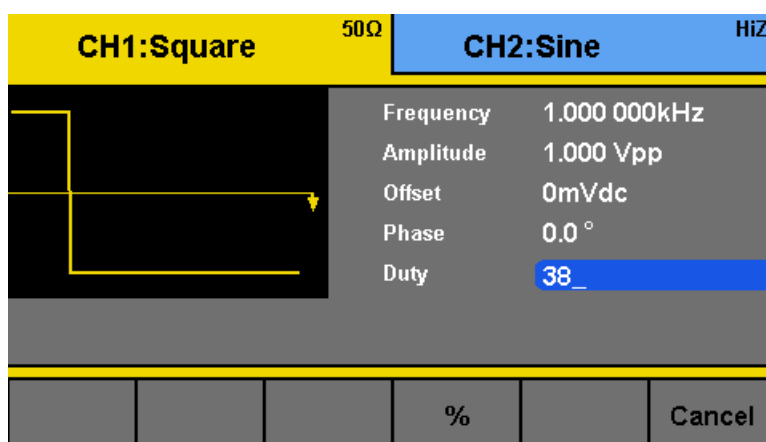

5. After entering the numeric value, use the menu function keys to select the percent (%) unit to apply for the duty cycle setting.

Note: The adjustable duty cycle range varies depending on the frequency of the waveform. Some frequencies do not allow change or very little change of the duty cycle and can be fixed at 50%.

Symmetry

Note: For ramp waveform only.

Follow the steps below to configure the symmetry of a ramp/triangle waveform.

1. Set the instrument for ramp wave output.
2. From the parameter menu, select **Symmetry**.
3. The cursor position will now highlight the first digit of the symmetry parameter display.

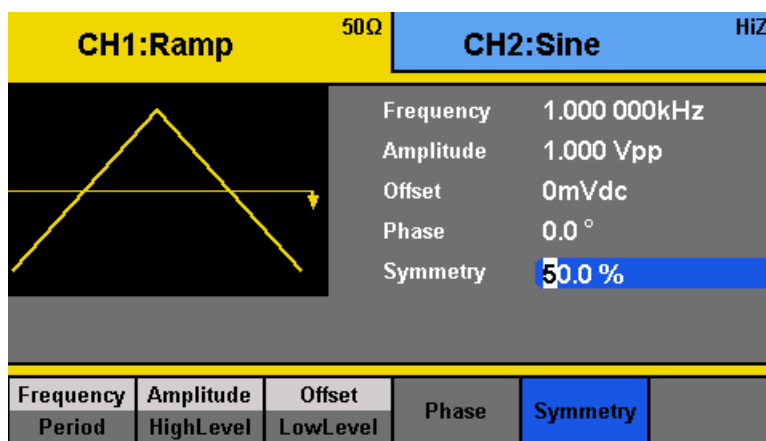

4. Use the rotary knob or the numeric keypad to change the symmetry. If numeric keypad is used, the following screen will be displayed:

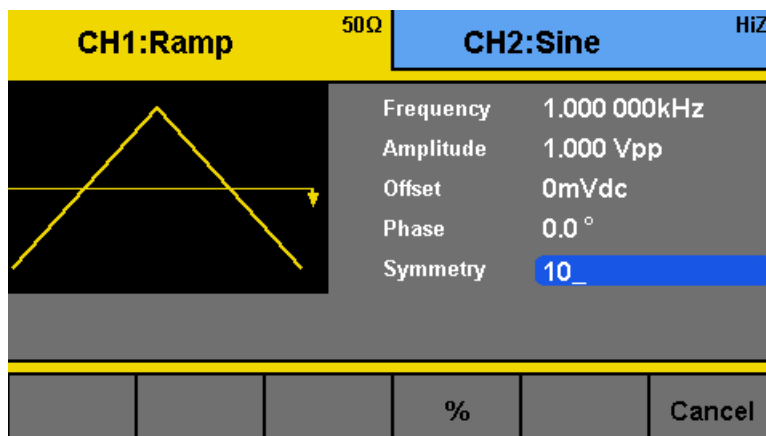

5. After entering the numeric value, use the menu function keys to select the percent (%) unit to apply for the symmetry setting.

Configure Pulse Waveform

Note: This section applies to pulse waveform only.

Pulse Width and Pulse Duty Cycle

The pulse width and duty cycle parameters are related and both control the length of the high level of the pulse. Users have the option to specify the pulse width in units of seconds or specify duty cycle as a percentage.

Note: The instrument allows for adjusting pulse width to a minimum of 12 ns and the pulse width change can be observed in increments of 1 ns.

Follow the steps below to configure the pulse width or duty cycle.

1. Set the instrument for a pulse output.
2. From the parameter menu, select **Width** for pulse width adjustment or **Duty** for duty cycle adjustment.
3. The cursor position will now highlight the first digit of the width or duty parameter display.

Frequency	300.000 000kHz	Frequency	300.000 000kHz
Amplitude	4.000 Vpp	Amplitude	4.000 Vpp
Offset	0mVdc	Offset	0mVdc
Pulse Width	666.6ns	Duty	20.000 0 %
Rise Edge	6.0ns	Rise Edge	6.0ns
Delay	0.0ns	Delay	0.0ns

4. Use the rotary knob or the numeric keypad to change the width or the duty. After entering the numeric value, use the menu function keys to select **s**, **ms**, **us**, or **ns** for pulse width or select percent (%) unit for duty cycle.

Pulse Delay

Follow the steps below to configure the pulse delay.

1. Set the instrument for pulse.
2. From the menu, select **Delay**.
3. The cursor position will now highlight the first digit of the delay parameter display.

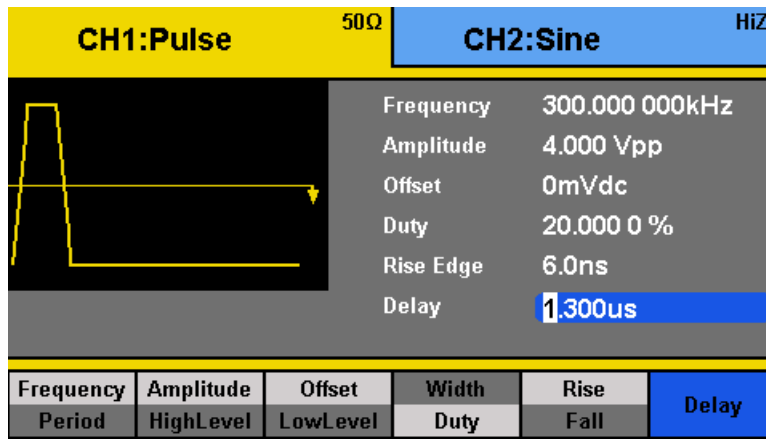

- Use the rotary knob or the numeric keypad to change the pulse delay. After entering the numeric value, use the menu function keys to select **s**, **ms**, **us**, or **ns**.

Rising or Falling Edge

Follow the steps below to configure the rising or falling edge times.

- Set the instrument for pulse output.
- From the parameter menu, select **Width** for pulse width adjustment or **Duty** for duty cycle adjustment.
- From the menu, select **Rise** for rising edge adjustment or **Fall** for falling edge adjustment.
- The cursor position will now highlight the first digit of the delay parameter display.

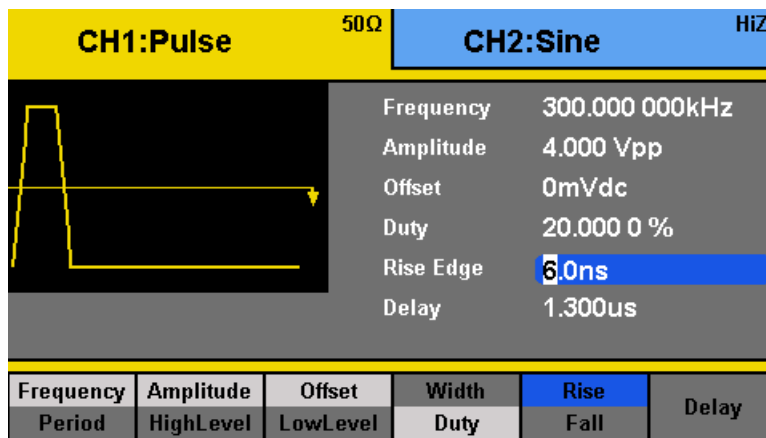

- Use the rotary knob or the numeric keypad to change the rising or falling edge. After entering the numeric value, use the menu function keys to select **s**, **ms**, **us**, or **ns**.

Configure Noise Waveform

Note: This section applies to noise waveforms only.

Standard Deviation and Mean

There are two parameters that can be adjusted of the noise waveform: Standard deviation and mean.

Follow the steps below to configure these parameters.

1. Set the instrument for noise output.
2. From the menu, select **Stdev** for the standard deviation adjustment or **Mean** for the mean adjustment.
3. The cursor position will now highlight the first digit of the standard deviation or mean parameter display.

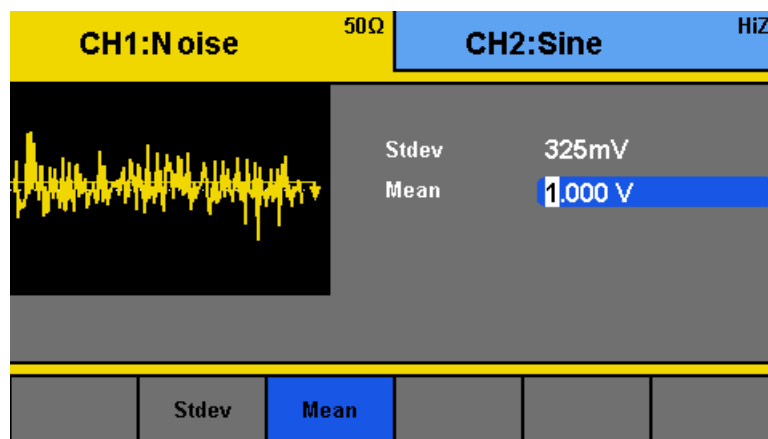
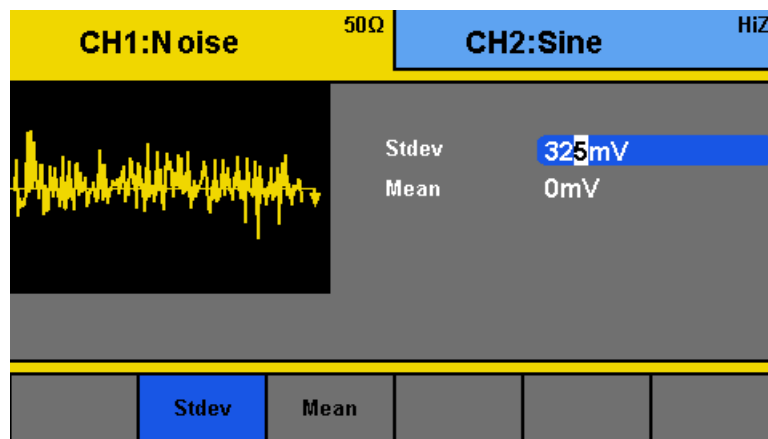

4. Use the rotary knob or the numeric keypad to change the two parameters. Both parameters can be specified in **V** or **mV** units.

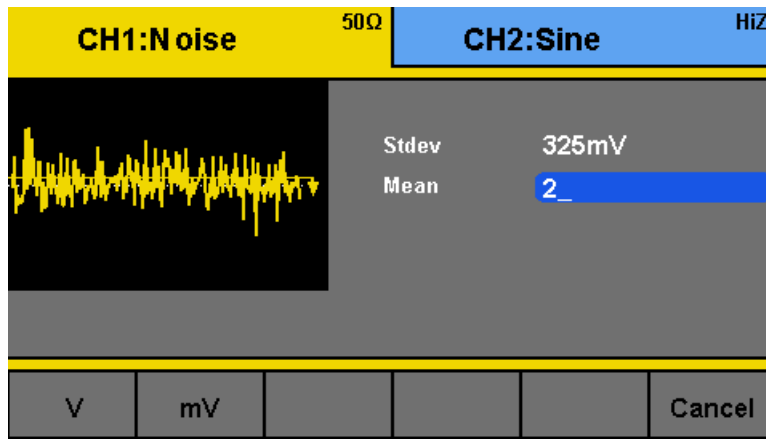

Configure DC Output Waveform

The instrument can output a DC waveform output at a range of voltage levels (-12 Vdc – 12 Vdc).

DC Offset

There is only one parameter, DC Offset, to configure a DC output waveform.

Follow the steps below to configure the parameter.

1. Set the instrument for DC output.
2. The cursor position will now be highlighted the first digit of the DC offset parameter display.

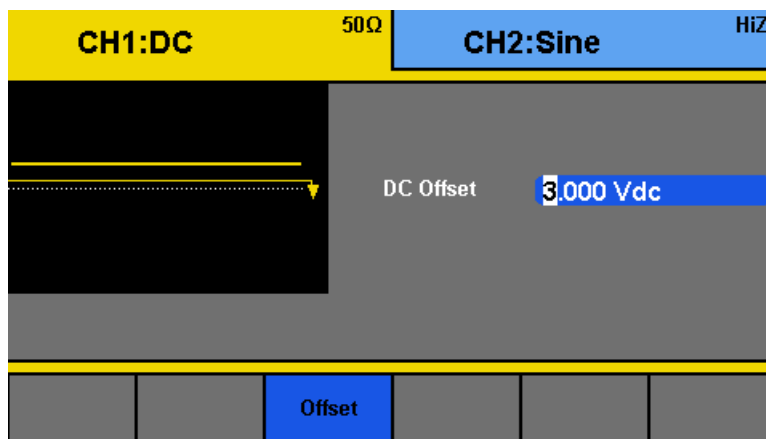

3. Use the rotary knob or the numeric keypad to change the two parameters. Both parameters can be specified in **Vdc** or **mVdc** units.

Configure Arbitrary Waveform

There are two ways to generate arbitrary waveforms. Users can output an arbitrary waveform selected from the built-in selection of predefined arbitrary waveforms, or create and output a user-defined waveform by specifying point by point arbitrary data using the EasyWave software. This section will explain how to do both.

Generate Predefined Built-in Waveforms

There are a total of 41 (including sine, square, ramp, pulse, and noise) predefined built-in arbitrary waveforms that can output from the generator. They are divided into four categories: Common waveforms, math waveforms, project waveforms, and Windowing/trigonometric waveforms.

Common Waveforms

StairUp	StairDn	StairUD	Trapezia	

Common waveforms consist of:

StairUp	Upward staircase	StairDn	Downward staircase
StairUD	Up and down staircase	Trapezia	Trapezoidal

Math Waveforms

ExpFall	ExpRise	LogFall	LogRise	Sqrt
X^2	Sinc	Gaussian	Dlorentz	Haversine
Lorentz	Gauspuls	Gmonopuls		

Math waveforms consist of:

ExpFall	Exponential fall	ExpRise	Exponential rise
LogFall	Logarithmic fall	LogRise	Logarithmic rise
Sqrt	Square root function	X^2	X ² function
Sinc	Sinc function	Gaussian	Gaussian function
Dlorentz	D-lorentz function	Haversine	Haversine function
Lorentz	Lorentz function	Gauspuls	Gaussian modulated sinusoidal pulse
Gmonopuls	Gaussian mono pulse		

Project Waveforms

Cardiac	Quake	TwoTone	SNR	

Project waveforms consist of:

Cardiac	Cardiac signal	Quake	Earthquake
TwoTone	Two tone signal	SNR	Sine with white noise

Window and Trigonometric Waveforms

Hamming	Hanning	Kaiser	Blackman	GaussiWin
Harris	Bartlett	Tan	Cot	Sec
Csc	Asin	Acos	Atan	ACot

Window and trigonometric waveforms consist of:

Hamming	Hamming window	Hanning	Hanning window
Kaiser	Kaiser window	Blackman	Blackman window
GaussiWin	Gaussian window		
Harris	Harris window	Bartlett	Bartlett window
Tan	Tangent function	Cot	Cotangent function
Sec	Secant function	Csc	Cosecant function
Asin	Inverse sine function	Acos	Inverse cosine function
Atan	Inverse tangent function	ACot	Inverse cotangent

Follow the steps below to browse and select a predefined arbitrary waveform.

1. Setup the instrument to access the arbitrary waveform function menu.
2. Select **Built-in** from the parameter menu and there will be a table on the display area and four categories to select from the parameter menu. Select **Common** to browse the common waveforms. Select **Math** to browse the math waveforms. Select **Project** to browse the project waveforms. Select **Win/Trig** to browse the window and trigonometric waveforms.
3. After making the selection, use the rotary knob to select the desired predefined waveform.

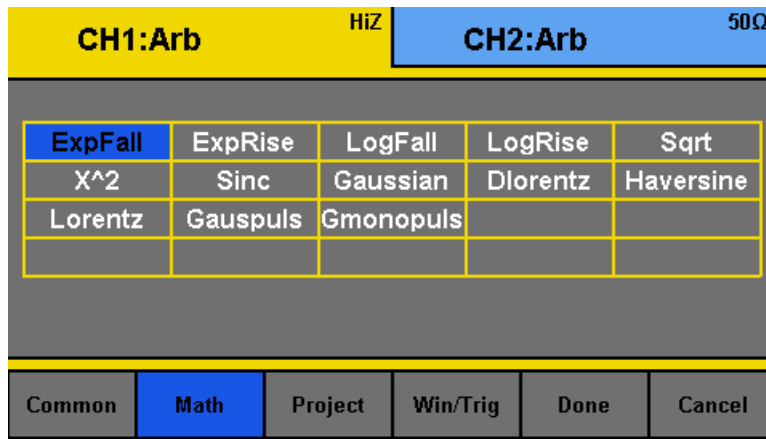

- Once selected, press the **Done** option from the menu.
- The generator will return to the main Arb parameter menu and the waveform display area will show the waveform shape of the selected predefined arbitrary waveform. For example, the screenshot below shows the display of the predefined **Cardiac** signal.

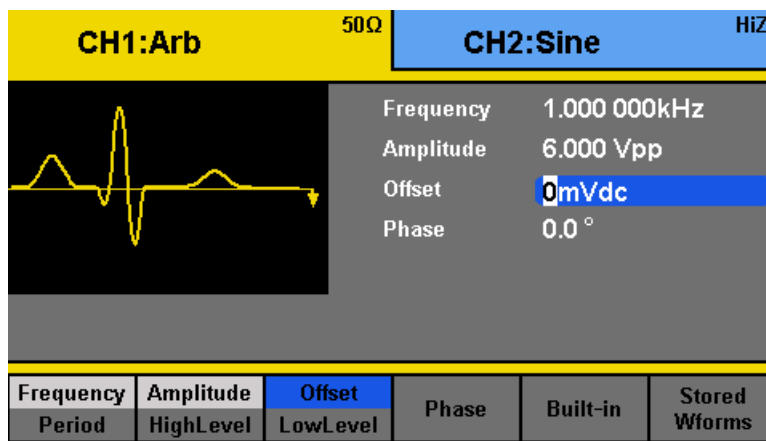

- Adjust frequency, amplitude, etc. as needed.

Generate User-Defined Waveforms

The generator has built-in non-volatile memory to store up to 32 user-defined arbitrary waveforms, 24 with a maximum of 16k points and 8 with a maximum of 512k points.

Note: Channel 1 can recall both, 16k point and 512k point waveforms, but is limited to output only 16k point waveforms natively. Recalled 512k point waveforms will be downscaled and interpolated to 16k point waveforms. Channel 2 can recall both, 16k point and 512k point waveforms natively.

To create an arbitrary waveform, users must use the USB interface in the rear panel for PC connectivity to the EasyWave software, which can be downloaded at www.bkprecision.com.

Note: EasyWave software supports Windows XP/Vista/7/8 (32 bit and 64 bit) only.

EasyWave software will allow users to easily create a custom arbitrary waveform and load it into the internal memory.

To select and output a saved arbitrary waveform from internal memory, follow the steps below.

1. Setup the instrument to access the arbitrary waveform function menu.
2. Select **Stored Waveforms** and there will be a table in the display area with the file names of all arbitrary waveforms that were created and loaded from EasyWave software.

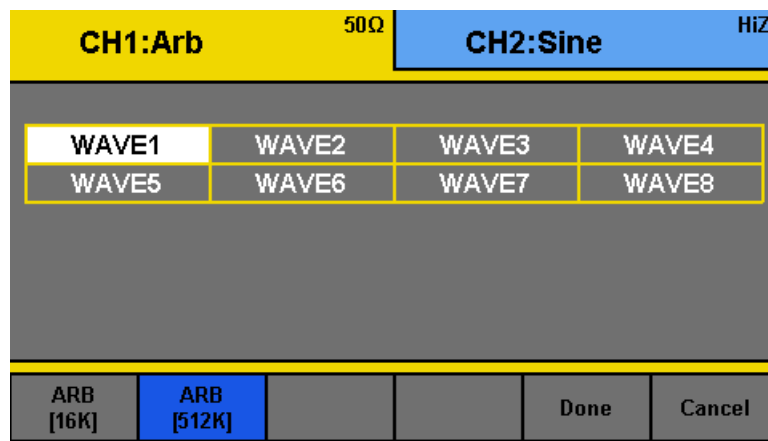

3. Use the rotary knob to select the arbitrary waveform to output from memory. Then, select the **Done** option from the parameter menu to load the waveform. The instrument will return to the main arb menu.

Note: Arbitrary waveforms created in EasyWave software can also be saved into a .csv file to an external USB flash drive, which can also be transferred and stored into the internal non-volatile arbitrary waveform memory. See “0” for details.

3.4 Configure Modulation Output

The modulation functions can be accessed by pressing the **Mod** button from the front panel. The supported types of modulation are: **AM, FM, PM, FSK, ASK, DSB-AM,** and **PWM.**

Note: Noise and DC waveforms cannot be modulated. PWM modulation can only be used with Pulse.

AM Modulation

Follow the steps below to set up amplitude modulation output.

1. Configure your waveform with the desired frequency and amplitude, then press the **Mod** button. Under **Type**, select **AM**. Then under **Modulate**, toggle **ON**.
2. There are four parameters that can be adjusted: **AM Freq**, **AM Depth**, **Shape**, and **Source**.

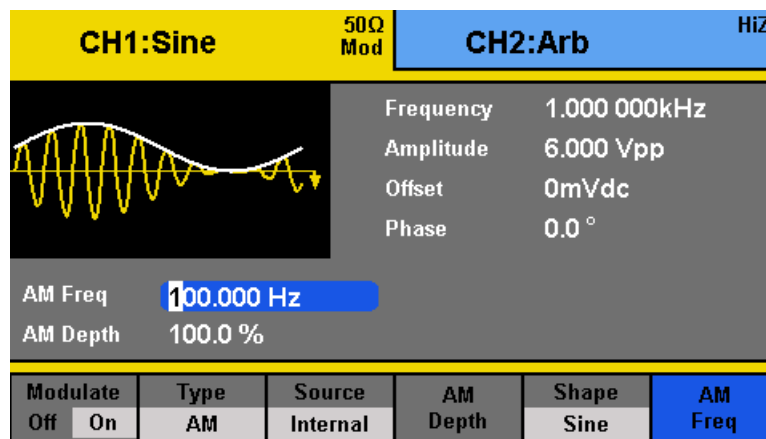

3. To adjust AM frequency, select **AM Freq** option from the menu. AM frequency parameter will be highlighted by the cursor on the first digit. Use the rotary knob or the numeric keypad to enter the modulating frequency.

AM Freq adjustable range: 1 mHz – 50 kHz

Note: Adjustable range is dependent on the carrier frequency.

4. Select **AM Depth** to adjust the depth of the amplitude modulation. Use the rotary knob or the numeric keypad to enter a depth percentage.

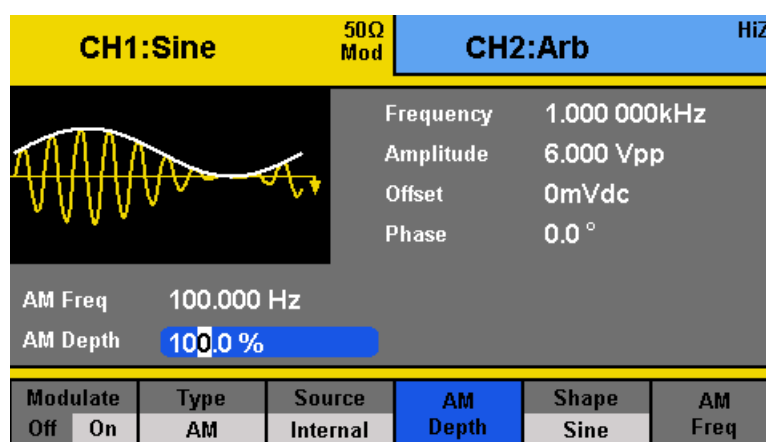

5. Select **Shape** to choose the shape of the modulating waveform. Options are: **Sine**, **Square**, **Triangle**, **UpRamp**, **DnRamp**, **Noise**, and **Arb**.

UpRamp = Upward ramp waveform

DnRamp = Downward ramp waveform

Arb = This will be the waveform that is currently loaded from within the arb function menu. To change, follow the instructions in the previous section.

6. Select **Source** and choose between **Internal** or **External**.

Internal – The modulating source will be generated internally using the **AM Freq**, **AM Depth**, and **Shape** as defined in the previous steps.

External – Use external modulating source. Users can connect an external signal into the rear BNC terminal labeled **Modulation In** as the modulating source. **AM Freq**, **AM Depth**, and **Shape** options will not be available.

⚠ WARNING: Do not connect more than ± 5 V into the Modulation In terminal. This will damage the instrument and void its warranty.

FM Modulation

Follow the steps below to set up frequency modulation output.

1. Configure your waveform with the desired frequency and amplitude, then press the **Mod** button. Under **Type**, select **FM**. Then under **Modulate**, toggle **ON**.
2. There are four parameters that can be adjusted: **FM Freq**, **FM Dev**, **Shape**, and **Source**.

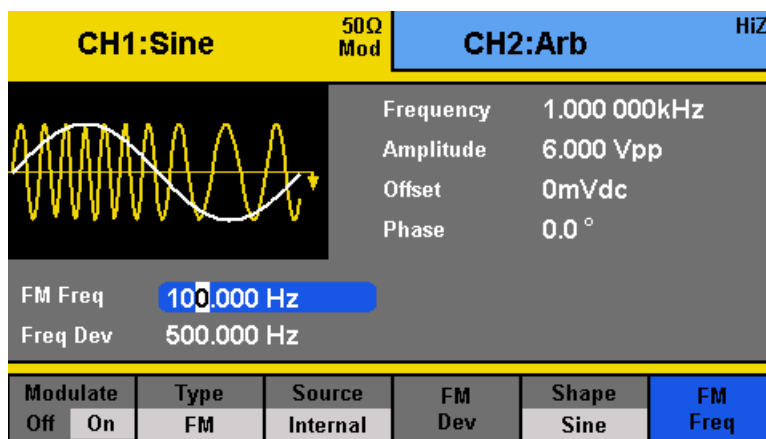

3. To adjust FM frequency, select **FM Freq** option from the menu. FM frequency parameter will be highlighted by the cursor on the first digit. Use the rotary knob or the numeric keypad to enter the modulating frequency.

FM Freq adjustable range: 1 mHz – 50 kHz

Note: Adjustable range is dependent on the carrier frequency.

4. Select **FM Dev** to adjust the maximum FM deviation. Use the rotary knob or the numeric keypad to enter the frequency.

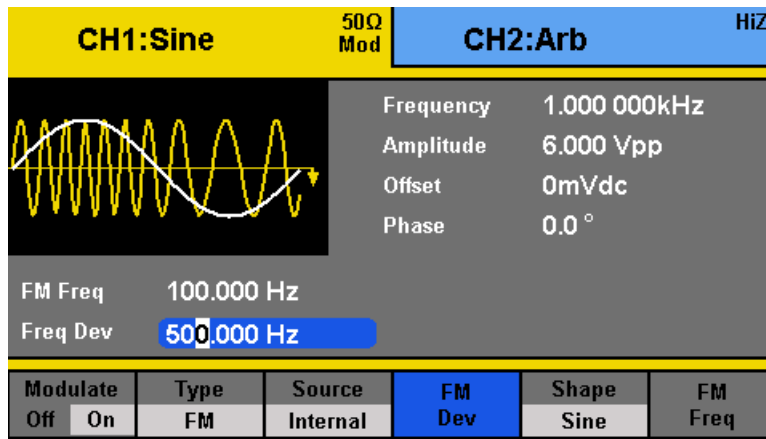

5. Select **Shape** to choose the shape of the modulating waveform. Options are: **Sine**, **Square**, **Triangle**, **UpRamp**, **DnRamp**, **Noise**, and **Arb**.
UpRamp = Upward ramp waveform
DnRamp = Downward ramp waveform
Arb = This will be the waveform that is currently loaded from within the arb function menu. To change, follow the instructions in the previous section.
6. Select **Source** and choose between **Internal** or **External**.

Internal – The modulating source will be generated internally using the **FM Freq**, **FM Dev**, and **Shape** as defined in the previous steps.

External – Use external modulating source. Users can connect an external signal into the rear BNC terminal labeled **Modulation In** as the modulating source. **FM Freq** and **Shape** options will not be available.

⚠ WARNING: Do not connect more than ± 5 V into the Modulation In terminal. This will damage the instrument and void its warranty.

PM Modulation

Follow the steps below to set up phase modulation output.

1. Configure your waveform with the desired frequency and amplitude, then press the **Mod** button. Under **Type**, select **PM**. Then under **Modulate**, toggle **ON**.
2. There are four parameters that can be adjusted: **PM Freq**, **Phase Dev**, **Shape**, and **Source**.

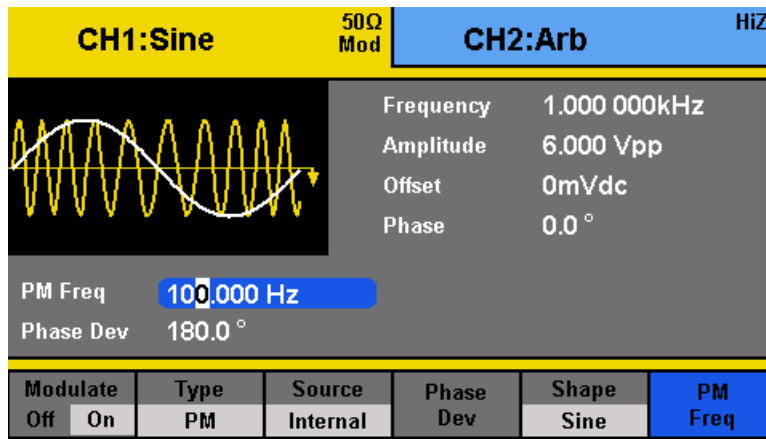

- To adjust PM frequency, select **PM Freq** option from the menu. PM frequency parameter will be highlighted by the cursor on the first digit. Use the rotary knob or the numeric keypad to enter the modulating frequency.

PM Freq adjustable range: 1 mHz – 50 kHz

Note: Adjustable range is dependent on the carrier frequency.

- Select **Phase Dev** to adjust the phase deviation. Use the rotary knob or the numeric keypad to enter the frequency.

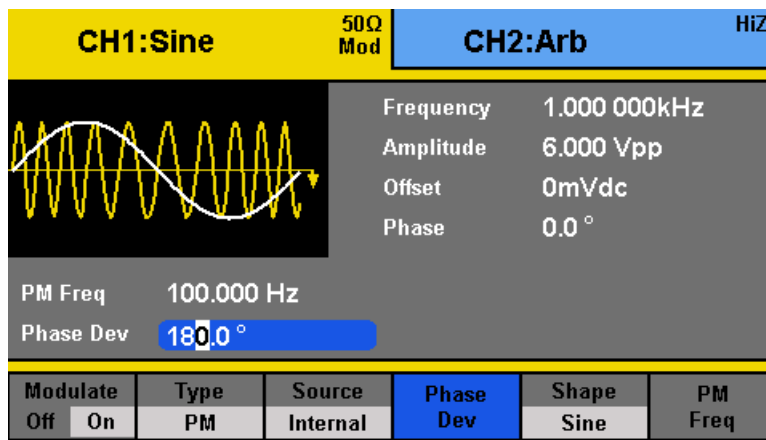

PM Deviation adjustable range: 0° – 360°

- Select **Shape** to choose the shape of the modulating waveform. Options are: **Sine, Square, Triangle, UpRamp, DnRamp, Noise, and Arb.**
UpRamp = Upward ramp waveform
DnRamp = Downward ramp waveform
Arb = This will be the waveform that is currently loaded from within the arb function menu. To change, follow the instructions in the previous section.
- Select **Source** and choose between **Internal** or **External**.

Internal – The modulating source will be generated internally using the **PM Freq, Phase Dev, and Shape** as defined in the previous steps.

External – Use external modulating source. Users can connect an external signal into the rear BNC terminal labeled **ExtTrig/Gate/FSK/Burst** as the modulating source. **PM Freq** and **Shape** options will not be available.

⚠ WARNING: Do not connect more than ± 5 V into the rear terminal. This will damage the instrument and void its warranty.

FSK Modulation

Follow the steps below to set up frequency shift keying modulation output.

1. Configure your waveform with the desired frequency and amplitude, then press the **Mod** button. Under **Type**, select **FSK**. Then under **Modulate**, toggle **ON**.
2. There are three parameters that can be adjusted: **Key Freq**, **Hop Freq**, and **Source**.

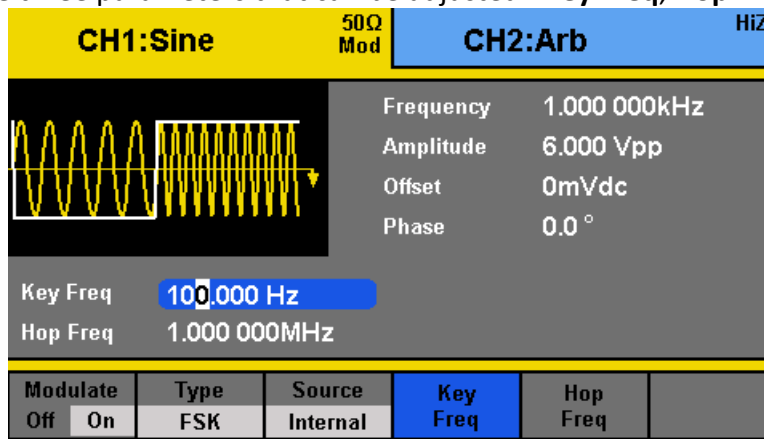

FSK Key Freq adjustable range: 1 mHz – 1 MHz

FSK Hop Freq adjustable range: 1 uHz – 160 MHz

Note: Adjustable range will vary depending on the waveform and the model.

3. To adjust FSK frequency, select **Key Freq** option from the menu. Key frequency parameter will be highlighted by the cursor on the first digit. Use the rotary knob or the numeric keypad to enter the modulating frequency. This is the frequency at which the output frequency shifts between the carrier frequency and the hop frequency.
4. Select **Hop Freq** to adjust the hop frequency.
5. Select **Source** and choose between **Internal** or **External**.

Internal – The modulating source will be generated internally.

External – Use external modulating source. Users can connect an external signal into the rear BNC terminal labeled **ExtTrig/Gate/FSK/Burst** as the modulating source.

⚠ WARNING: Do not connect more than ± 5 V into the rear terminal. This will damage the instrument and void its warranty.

ASK Modulation

Follow the steps below to set up amplitude shift keying modulation output.

1. Configure your waveform with the desired frequency and amplitude, then press the **Mod** button. Under **Type**, select **ASK**. Then under **Modulate**, toggle **ON**.
2. There are two parameters that can be adjusted: **Key Freq** and **Source**.



ASK Key Freq adjustable range: 1 mHz – 1 MHz

Note: Adjustable range will vary depending on the waveform and frequency supported by the model..

3. To adjust ASK frequency, select **Key Freq** option from the menu. Key frequency parameter will be highlighted by the cursor on the first digit. Use the rotary knob or the numeric keypad to enter the modulating frequency. This is the frequency at which the output amplitude shifts between the carrier amplitude and 0.
4. Select **Source** and choose between **Internal** or **External**.

Internal – The modulating source will be generated internally.

External – Use external modulating source. Users can connect an external signal into the rear BNC terminal labeled **ExtTrig/Gate/FSK/Burst** as the modulating source.

⚠ WARNING: Do not connect more than ± 5 V into the rear terminal. This will damage the instrument and void its warranty.

DSB-AM

Follow the steps below to set up double-sideband amplitude modulation output.

1. Configure your waveform with the desired frequency and amplitude, then press the **Mod** button. Under **Type**, select **DSB-AM**. Then under **Modulate**, toggle **ON**.
2. There are three parameters that can be adjusted: **DSB Freq**, **Shape**, and **Source**.
3. To adjust DSB frequency, select **DSB Freq** option from the menu. DSB-AM frequency parameter will be highlighted by the cursor on the first digit. Use the rotary knob or the numeric keypad to enter the DSB modulating frequency.

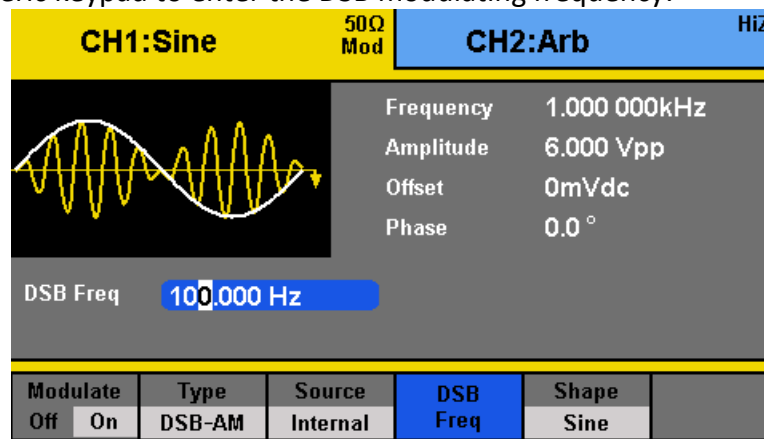

DSB Freq adjustable range: 1 mHz – 50 kHz

Note: Adjustable range is dependent on the carrier frequency.

4. Select **Shape** to choose the shape of the modulating waveform. Options are: **Sine**, **Square**, **Triangle**, **UpRamp**, **DnRamp**, **Noise**, and **Arb**.
UpRamp = Upward ramp waveform
DnRamp = Downward ramp waveform
Arb = This will be the waveform that is currently loaded from within the arb function menu. To change, follow the instructions in the previous section.
5. Select **Source** and choose between **Internal** or **External**.

Internal – The modulating source will be generated internally using the **DSB Freq** and **Shape** as defined in the previous steps.

External – Use external modulating source. Users can connect an external signal into the rear BNC terminal labeled **Modulation In** as the modulating

source. **DSB Freq** and **Shape** options will not be available.

⚠ WARNING: Do not connect more than ± 5 V into the Modulation In terminal. This will damage the instrument and void its warranty.

PWM Modulation (Pulse Only)

Follow the steps below to set up pulse width modulation output.

1. Configure your pulse waveform with the desired frequency and amplitude, then press the **Mod** button.
2. PWM is automatically selected. There are four parameters that can be adjusted: **PWM Freq**, **Width Dev**, **Shape**, and **Source**.

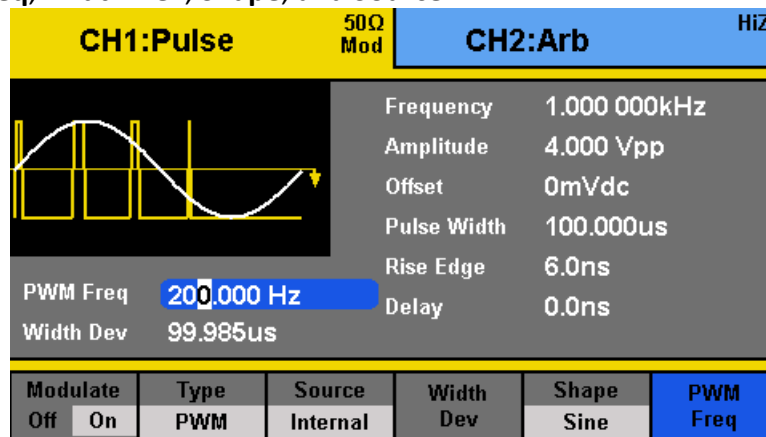

3. To adjust PWM frequency, select **PWM Freq** option from the menu. PWM frequency parameter will be highlighted by the cursor on the first digit. Use the rotary knob or the numeric keypad to enter the modulating frequency.

PWM Freq adjustable range: 1 mHz – 50 kHz

Note: Adjustable range is dependent on the carrier frequency.

4. Select **Width Dev** to adjust the pulse width deviation. Use the rotary knob or the numeric keypad to enter the frequency.

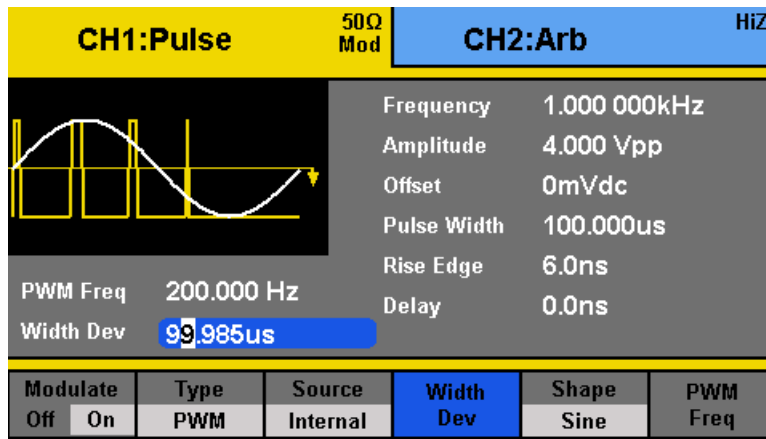

Note: Width deviation adjustable range is dependent on the carrier frequency and pulse width.

- Select **Shape** to choose the shape of the modulating waveform. Options are: **Sine**, **Square**, **Triangle**, **UpRamp**, **DnRamp**, **Noise**, and **Arb**.
UpRamp = Upward ramp waveform
DnRamp = Downward ramp waveform
Arb = This will be the waveform that is currently loaded from within the arb function menu. To change, follow the instructions in the previous section.
- Select **Source** and choose between **Internal** or **External**.

Internal – The modulating source will be generated internally using the **PWM Freq**, **Width Dev**, and **Shape** as defined in the previous steps.

External – Use external modulating source. Users can connect an external signal into the rear BNC terminal labeled **Modulation In** as the modulating source. **PWM Freq** and **Shape** options will not be available.

⚠ WARNING: Do not connect more than ± 5 V into the rear terminal. This will damage the instrument and void its warranty.

3.5 Configure Sweep Output

Note: Sweep function is only available for sine, square, ramp, and arbitrary waveforms. It is not available for pulse, noise, or DC waveforms.

Burst function cannot operate when in sweep mode.

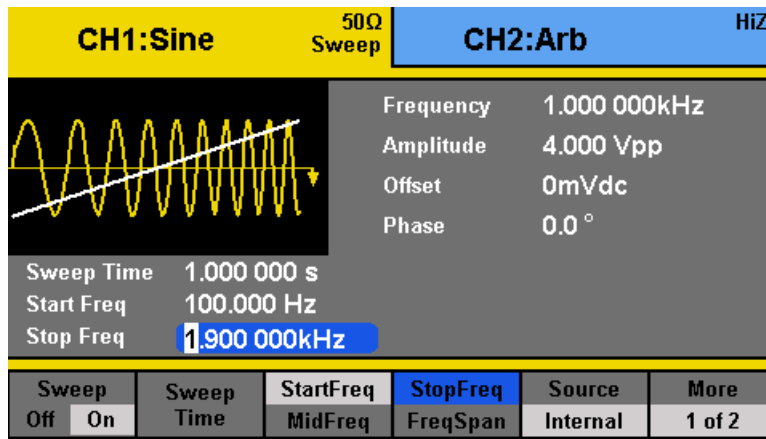

Follow the steps below to set up a sweep output from the generator.

1. Configure your waveform with the desired frequency and amplitude, then press the **Sweep** button.
2. There are many adjustable parameters to configure the sweep function: **Sweep Time**, **StartFreq**, **MidFreq**, **StopFreq**, **FreqSpan**, **Source**, **Trig Out** (internal source), **Edge** (external source), **Linear/Log**, **Direction**, and **Trigger** (manual source).
3. To set the sweep time/rate, select **Sweep Time** from the menu and use the rotary knob or the numeric keypad to enter the sweep time in seconds.
Sweep time is the number of seconds required to sweep from the start to stop frequency. The generator will calculate the number of points required in the sweep based on this time.
4. To set the start frequency, select **StartFreq** from the menu and use the rotary knob or the numeric keypad to enter the start frequency in Hz.
Start Frequency is the frequency to which the sweep begins.
5. To set the center frequency, select **MidFreq** from the menu and use the rotary knob or the numeric keypad to enter the center frequency in Hz.
Center Frequency is the frequency at the center of the sweep. (Used with FreqSpan)
6. To set the stop frequency, select **StopFreq** from the menu and use the rotary knob or the numeric keypad to enter the stop frequency in Hz.
Stop Frequency is the frequency to which the sweep ends.
7. To set the frequency span, select **FreqSpan** from the menu and use the rotary knob or the numeric keypad to enter the frequency span.
Frequency Span controls the range of frequency to sweep. (Used with MidFreq)
8. Select **Source** and choose between **Internal**, **External**, or **Manual**.

Internal – Internal trigger source.

External – External trigger source. Users can connect an external signal into the rear BNC terminal labeled **ExtTrig/Gate/FSK/Burst** to trigger the sweep.

Manual – Manual trigger source.

9. Press the **More 1 of 2** option to go to the second page of the menu.
If **Internal** source is previously selected, the **Trig Out** option will be available.

On – A square waveform (pulse for manual trigger) will output from the **ExtTrig** BNC connector at the beginning of the sweep. The frequency corresponds to the sweep time (except for manual trigger).

Off – Trigger output be disabled

If **External** source is previously selected, the **Edge** option will be available, and the **Trig On** option will not be available.

Up – Triggers off the rising edge of the external signal.

Down – Triggers off the falling edge of the external signal.

If **Manual** source is previously selected, the **Trigger** option in RED will be available. Each press of this option using the function key on the front panel will trigger a sweep.

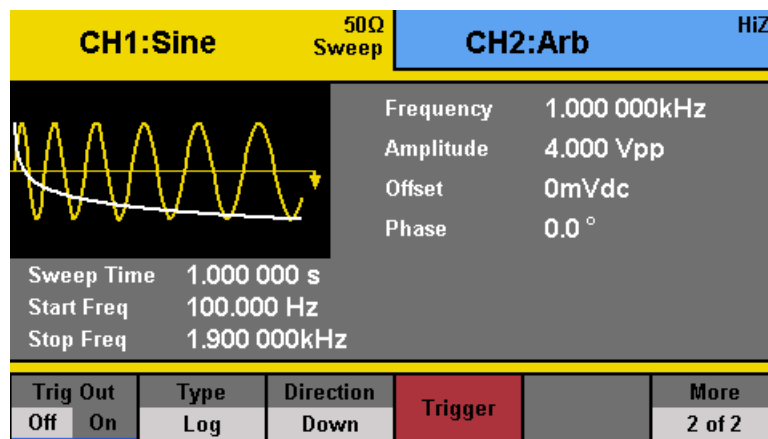

10. Use the function key to toggle selection between **Linear** or **Logarithmic** sweep. You can see which type is selected from the waveform display area.

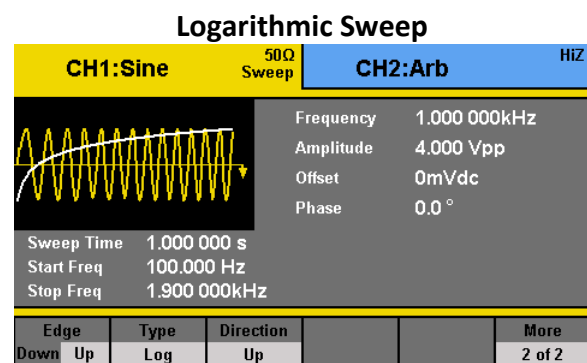
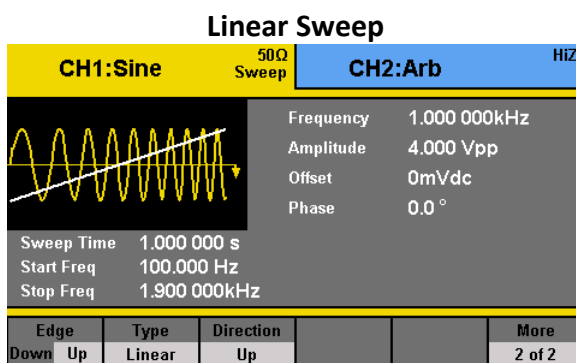

11. The direction of the sweep can be changed by toggling the function key corresponding to the **Direction** option.

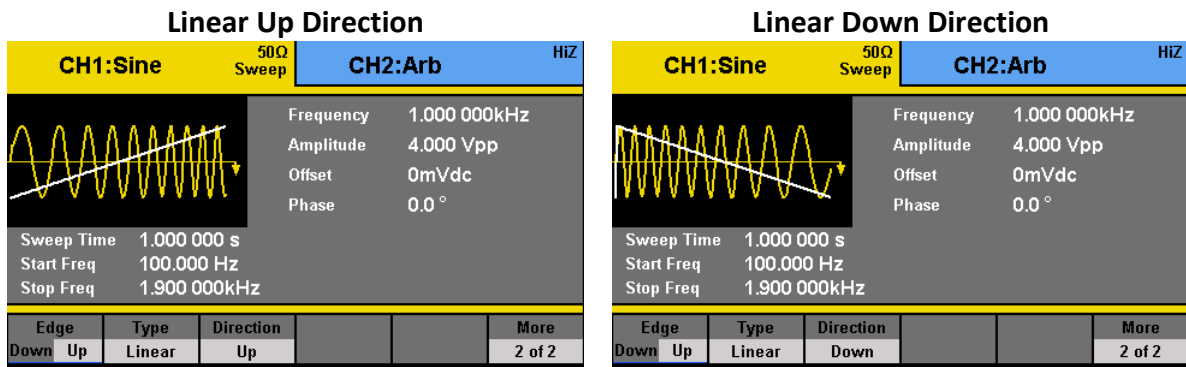

Up – The sweep will be in the normal direction (sweep up).

Down – The sweep will be in the reverse direction (sweep down).

3.6 Configure Burst

Note: Burst function is available for all waveforms, with the limitation on noise waveform in which only gated burst function is supported.

Sweep function cannot operate when in burst mode.

Gated burst operation is for use with an internal or external source only.

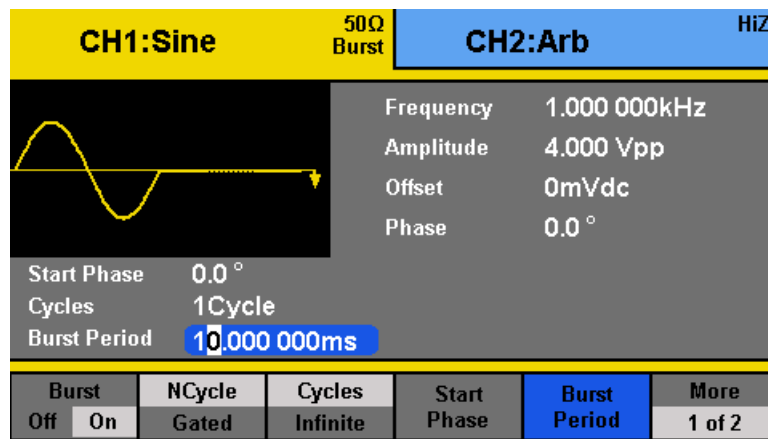

Follow the steps below to set up a burst output from the generator.

1. Configure your waveform with the desired frequency and amplitude, then press the **Burst** button.
2. There are many adjustable parameters to configure the sweep function: **Burst Period**, **Start Phase**, **NCycle**, **Gated**, **Source**, **Trig Out** (internal and manual source), **Edge** (external source), **Cycles/Infinite**, **Delay**, and **Trig** (manual source).
3. To set the burst period (rate), select **Period** from the menu and use the rotary knob or the numeric keypad to enter in seconds.
Burst Period/Rate is the frequency of the burst.

- To set the start phase, select **StartPhase** from the menu and use the rotary knob or the numeric keypad to enter in degrees.

Start Phase is the phase of the waveform where the burst will begin.

- There are two configurations that can be set for the burst function. One is to burst with control over the number of cycles. The other is gated burst. Toggle the menu function key to select **Ncycle** or **Gated** from the menu.

Ncycle – Use specified number of cycles of the waveform from the **Cycles** menu option to burst.

Gated – Use internal or external source to control the burst output. To use with internal source, select **Internal** for **source** and **Period** to adjust the burst period prior to selecting this option.

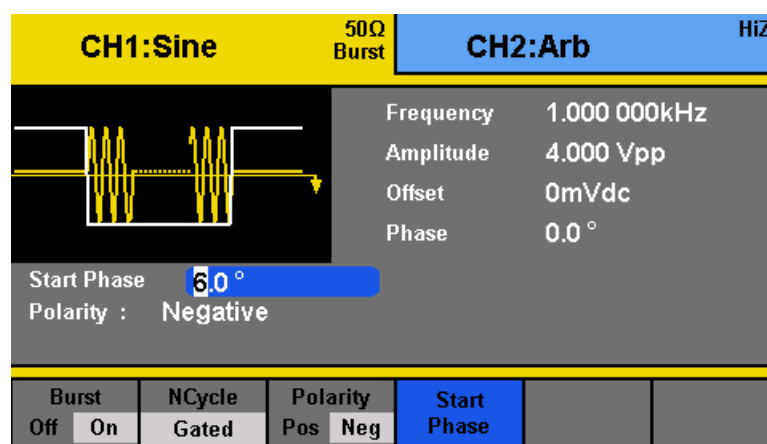

- Select **Source** and choose between **Internal**, **External**, or **Manual**.

Internal – Internal trigger source. Burst will be controlled by the specified burst period.

External – External trigger source. Users can connect an external signal into the rear BNC terminal labeled **ExtTrig/Gate/FSK/Burst** to trigger the burst. This is for both **Ncycle** and **Gated** burst operations.

Manual – Manual trigger source.

- If **Gated** option is selected, a **Polarity** option will be available. Toggle the corresponding menu function key to select between **Pos** or **Neg**.

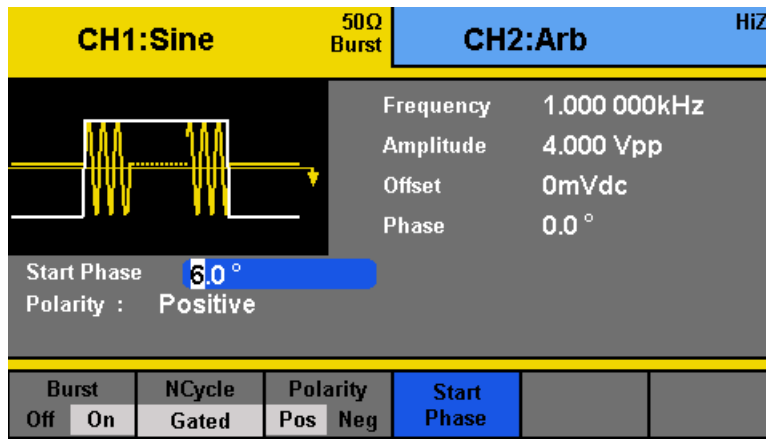

Pos – The positive polarity (High level) will cause the gated burst output.

Neg – The negative polarity (Low level) will cause the gated burst output.

8. Press the **More 1 of 2** option to go to the second page of the menu.
If **Internal** source is selected previously, the **Trig Out** option will be available.
-

Up – The start of the burst will be triggered on the rising edge of the square waveform with 50% duty cycle outputted from the **ExtTrig** BNC connector. The frequency corresponds to the burst period.

Down – The start of the burst will be triggered on the falling edge of the square waveform with 50% duty cycle outputted from the **ExtTrig** BNC connector. The frequency corresponds to the burst period.

Off – Trigger output be disabled

If **External** source is selected, the **Edge** option will be available, and the **Trig Out** option will not be available.

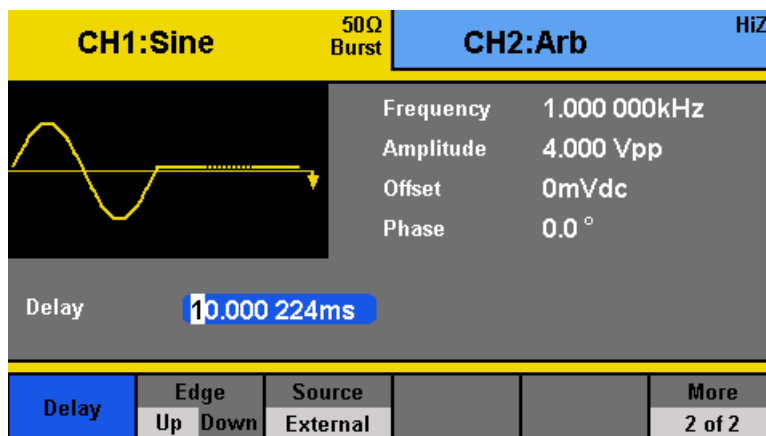

Up – Triggers off the rising edge of the external signal.

Down – Triggers off the falling edge of the external signal.

Note: These options are not available for Gated burst operations.

If **Manual** source is previously selected, the **Trigger** option in RED will be available on the first page of the menu. Each press of this option using the function key on the front panel will trigger a burst. The **Trig Out** option will also be available.

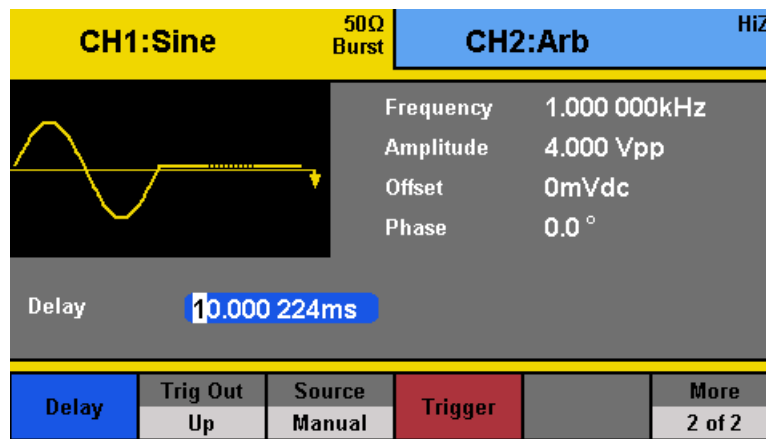

Up – The start of the burst will be triggered on the rising edge of a pulse waveform (>1 μHz) outputted from the **ExtTrig** BNC connector.

Down – The start of the burst will be triggered on the falling edge of a pulse waveform (>1 μHz) outputted from the **ExtTrig** BNC connector.

Off – The pulse output from the **ExtTrig** BNC connector is disabled.

9. If **Ncycle** is selected in the previous steps, the **Cycles/Infinite** option will be available. Use the corresponding menu function key to toggle between the two options. If **Cycles** is selected, use the rotary knob or the numeric keypad to enter the number of cycles to burst.

Cycles – Select to specify the number of cycles of the waveform to burst.

Adjustable range is 1 – 1,000,000 cycles

Infinite – Select to burst an infinite number of cycles of the waveform. This will create a continuous waveform which will not be stopped until an external trigger event occurs.

Note: For Infinite cycle, external or manual trigger is required to trigger the burst.

10. If **Ncycle** is selected in the previous steps, the **Delay** option will be available. Select it and use the rotary knob or the numeric keypad to adjust the burst delay.

Maximum delay is 34 s.

Minimum delay is dependent on frequency and waveform.

Note: If required, the burst period will increase to accommodate the specified number of cycles. If infinite cycle is selected, external or manual source is required to trigger the burst output. The default is external source.

3.7 Utility Functions

The utility menu can be accessed by pressing the **Utility** button from the front panel. This section describes all the settings configurable under this menu.

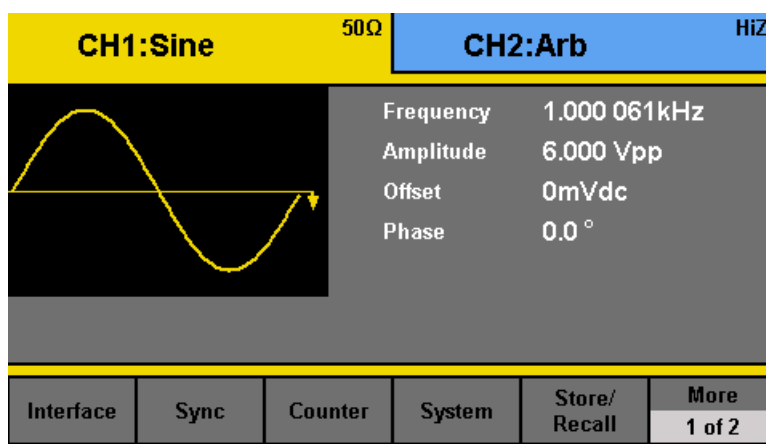

Remote Interface

USB Interface

The instrument has a USB interface (USBTMC) in the rear panel for remote communication with EasyWave software. From the utility menu, press **Interface** to select the interface. Press **USB Setup** and select **USBTMC**, then select **Done**.

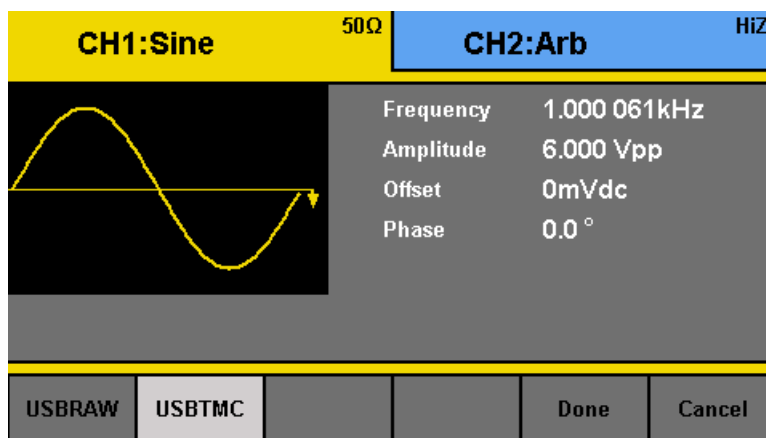

Note: USBRAW is reserved for factory use only.

A type A to type B USB cable is required for PC connectivity.

To connect with EasyWave software, you must install the USB driver. For Windows® 7 and 8 users, this may install automatically. For other users, visit www.bkprecision.com to download the driver.

Note: Users who have LabVIEW™ or NI-VISA installed will automatically have this driver in their system. In this case, driver download is not required.

GPIB Interface

The generator can be remotely controlled via GPIB using the optional **AK40G USB-to-GPIB adapter**.

Note: The AK40G is an adapter and not a GPIB controller. The computer must have a GPIB bus controller to connect to the adapter.

Note: Be sure all devices are powered off before connecting the adapter to the USB port of the generator and/or the GPIB port on your computer.

Connecting AK40G

1. Connect the USB end of the AK40G to the front USB host port of the instrument. Since this port is a shared port, an external USB flash drive cannot be used during GPIB operation.
2. Connect the GPIB end of the AK40G to the computer's GPIB bus controller via a GPIB cable.
3. On the AK40G adapter, a RED LED light indicates power to the adapter. A YELLOW LED light indicates communication is in process.

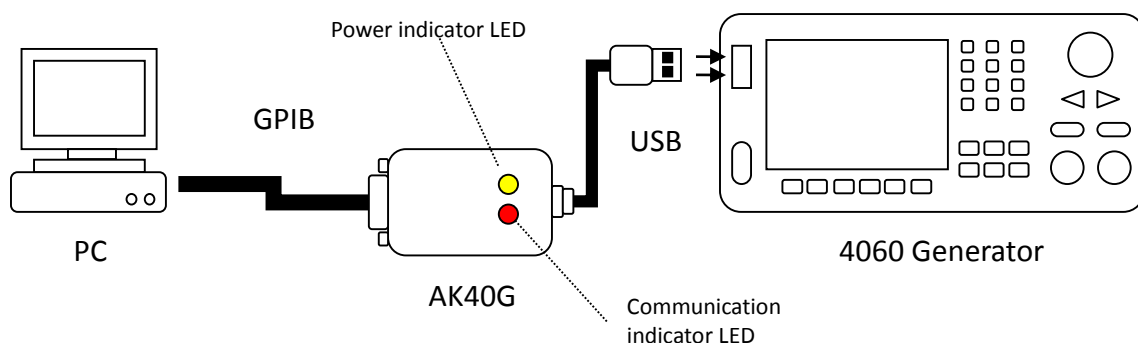

Figure 1 - Connecting AK40G GPIB adapter

Note: Once connected, do not unplug the adapter on either end before powering down the instrument and the computer first.

Configure GPIB address

1. Press **Utility** to enter the utility menu, and press **Interface** to select the interface.
2. Press **GPIB** and use the rotary knob to set the GPIB address of the generator. The address range is 1 to 30.
3. Be sure that **GPIB** is highlighted to indicate GPIB as the selected interface for remote communication. Then, select **Done**.

Note: EasyWave software does not support GPIB interface. It must be used with USB interface only.

Note: All supported remote commands are described in the programming manual which can be downloaded from the B&K Precision website www.bkprecision.com .

Sync Output

Note: Sync output is not available for noise and DC waveforms.

The rear panel has a **Sync Out** BNC terminal available to provide a synchronization output signal. This output can be enabled and can be setup to provide a sync signal that correlates with channel 1 or channel 2.

To set up, press the **Sync** option from the utility menu.

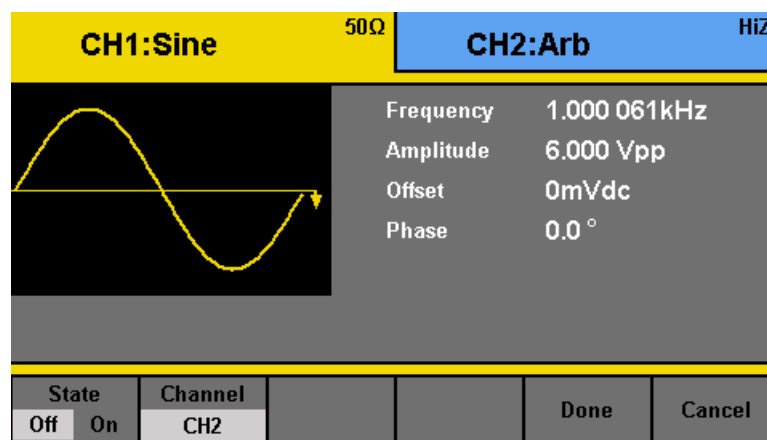

Under **Channel**, use the corresponding menu function key to select **CH1** or **CH2**. This will select the channel the output signal will be synchronized with.

To enable the sync output, select **On** for the **State** option.
To disable the sync output, select **Off** for the **State** option.

When finished, select **Done**. To cancel, select **Cancel**.

Note:

- When waveform is inverted, the corresponding sync signal does not invert.
 - For non-modulated waveform, the sync output reference is the carrier.
 - For internal modulating AM, FM, and PM, the sync output reference is the modulated signal (not the carrier).
 - For ASK and FSK, the sync output reference is the keying frequency.
 - When sweep is enabled, the sync output becomes TTL level high at the start of the sweep, and the sync frequency will be the same as the specified sweep time.
 - When burst is enabled, the sync output will be TTL level high at the start of the burst.
 - For external gated burst, the sync output follows the external gated signal.
-

Frequency Counter

The instrument has a built-in frequency counter. The counter input shares the same BNC terminal as the channel 1 main output terminal, labeled **CNT**. To access and enable the counter function, select the **Counter** option from the utility menu.

Note: When the counter function is enabled, channel 1 will automatically be disabled and the same BNC terminal will become the counter's input terminal.

CH1:Sine 50Ω		CH2:Square HiZ			
Frequency	1.999 999 Hz				
Positive Width	99.999 986ms				
Duty	19.9 %				
Freq Deviation	-999999.800 000ppm				
RefeFreq	10.000 000MHz				
State	Frequency	Pwidth	RefeFreq	Setup	Cancel
Off	On	Period	Nwidth	TrigLev	

There are several measurement parameters that can be displayed when counter is enabled.

Measure Frequency/Period

The instrument can measure in frequency or period by selecting **Freq** or **Period** respectively from the counter menu.

Measure Width and Duty

The width of the signal can be measured. This parameter is especially useful for measuring

square and pulse signals. Users can select between measuring positive or negative width by selecting **PWidth** or **NWidth** respectively from the counter menu. Users can also measure the duty cycle in percent of the signal by selecting **Duty** from the menu.

Adjust Reference Frequency

The default reference frequency used by the counter is 10 MHz. Users can change this reference frequency by selecting **RefeFreq** and use the rotary knob or the numeric keypad to change the reference frequency value.

CH1:Sine HiZ		CH2:Square HiZ			
Frequency	< 100mHz				
Positive Width	0.0ns				
Duty	0.0%				
Freq Deviation	-1000000.000 000ppm				
RefeFreq	2_				
MHz	kHz	Hz	mHz	uHz	Cancel

Adjust Trigger Level

The trigger level of the counter can be adjusted by selecting **TrigLev** from the menu. Use the rotary knob or the numeric keypad to change the trigger level. The maximum trigger level value is 1.8 V, and the minimum is – 3.0 V.

CH1:Sine HiZ		CH2:Square HiZ			
Frequency	< 100mHz				
Positive Width	0.0ns				
Duty	0.0%				
Freq Deviation	-1000000.000 000ppm				
Trigger Level	-3.000V				
State	Frequency	Pwidth	RefeFreq	Setup	Cancel
Off On	Period	Nwidth	TrigLev		

Counter Settings

There are some additional counter settings that can be adjusted, which may help improve the counter measurements of some signals.

To access these settings, select **Setup** from the counter menu, and an expanded set of menu options will be available.

CH1:Sine		HiZ	CH2:Square		HiZ
Frequency	< 100mHz				
Positive Width	0.0ns				
Duty	0.0%				
Freq Deviation	-1000000.000 000ppm				
Trigger Level	-3.000V				
Mode	HFR		Default	Done	
AC	Off	On			

Coupling

The counter can be set to AC or DC coupling. Select **Mode** from the menu and toggle the corresponding menu function key to change between **DC** or **AC** for DC and AC coupling respectively.

HFR

A high frequency reject filter can be enabled or disabled. Enabling this filter may help improve the frequency measurements of certain signals. From the menu, select **HFR** and toggle the corresponding menu function key to turn it **On** or **Off**.

Default Settings

All of the counter settings can be configured to default values by selecting **Default** from the menu. Below is a table of the default settings.

Counter Parameters	Default Settings
Reference Frequency (RefeFreq)	10.000000 MHz
Trigger Level (TrigLev)	0.0 V
Coupling (Mode)	AC
High Frequency Reject Filter (HFR)	Off

Select **Done** to return to the counter main menu.

System Settings

In the utility menu, select the **System** option.

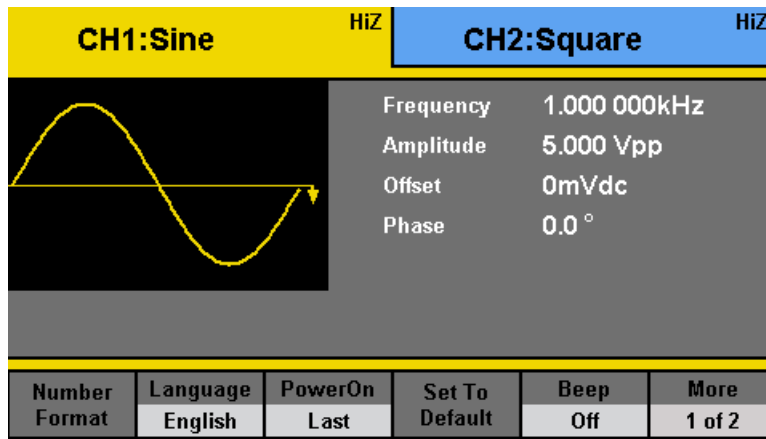

Numerical Format

The number format can be changed on the instrument. Select **Number Format** from the menu.

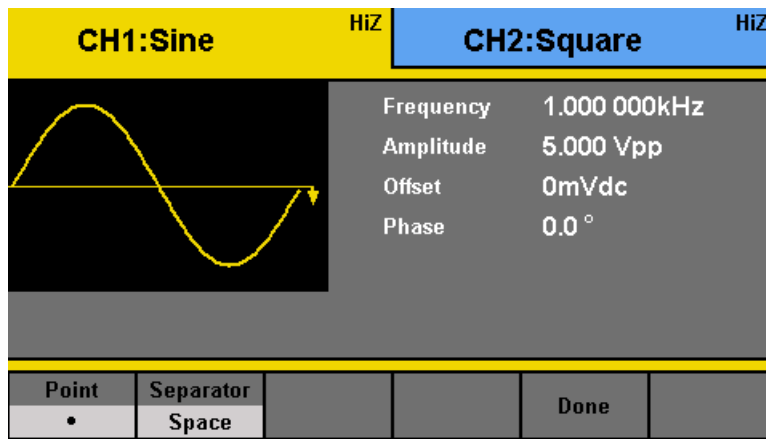

Toggle the corresponding menu function key to select **Point** to choose between using period (.) or comma (,) as the decimal representation of all numerical values on display.

Numeric separators can also be configured by selecting the **Separator** option. Choose between **On**, **Off**, or **Space**. Below illustrates the difference between the three on all applicable numerical values on the display.

Frequency	1.000 000kHz
Amplitude	5.000 Vpp
Offset	0mVdc
Phase	0.0 °

Separator: Space

Frequency	1.000000kHz
Amplitude	5.000 Vpp
Offset	0mVdc
Phase	0.0 °

Separator: Off

Frequency	1.000,000kHz
Amplitude	5.000 Vpp
Offset	0mVdc
Phase	0.0 °

Separator: On

Select **Done** when finished.

Language

Default language is **English**. It can be changed to **simplified Chinese** by toggling the **Language** option in the system menu. Press the corresponding menu function key to toggle between the two languages.

Power-On Settings

The power-on instrument settings can be configured to load the default values or values configured during the last power-on state. This function can be used to retain instrument configurations in the case of power interruptions.

Press the **PowerOn** option from the menu to select between **Default** and **Last**.

Default will load default instrument settings during power up.

Last will load instrument settings from the last power up state.

Note: The output states of both channels can be recalled at power-on. For safety reasons, the states are disabled by default to protect sensitive device under test.

Set to Factory Default

You can set the instrument settings to factory default by selecting **Set to Default**. The instrument will change all settings to default, and the screen will return to the main display with Sine wave active.

Below is a table of the factory default settings:

Parameters	Default Settings
Function	Sine Wave
Frequency	1.000000 kHz
Amplitude	100 mVpp
Offset	0 V
Phase	0 °
Output Impedance	HighZ
Modulation	
Carrier Frequency	1.000000 kHz
Modulating Frequency	100 Hz
Modulation Shape	Sine Wave
AM Depth	100 %
FM Deviation	500 Hz
Key Frequency	100 Hz
FSK Hop Frequency	1 MHz
Phase Deviation	0.0 °
DSB Frequency	100 Hz
Sweep	
Start/Stop Frequency	100 Hz/1.9 kHz
Sweep Time	1 second
Trig Out	Off
Mode	Linear
Direction	Up
Burst	
Period	10.000 ms
Phase	0 °
Count	1 Cycle
Delay	332 ns
Trig	Off
Source	Internal
Counter	
Measurement Mode	Frequency
Reference Frequency	10.000000 MHz
Trigger Level	0.0 V
Mode	AC
HFR	Off

Key Sound (Beep)

Select **Beep** and toggle the corresponding menu function key to turn the instrument key press sound **On** or **Off**. This will also disable the sound for any errors that may occur during front panel or remote operation.

Screen Saver

The instrument has a built-in screen saver function that automatically dims the display when left idle over a period of time specified by a timer. The timer can be changed by selecting the **ScrnSvr** option from the menu. Press the corresponding menu function key to change between: **1 min**, **5 min**, **15 min**, **30 min**, **1 hour**, **2 hours**, **5 hours**, or **Off**.

Clock Source

By default, the instrument uses an internal clock source to generate output waveforms. An external 10 MHz clock source can also be used, especially for synchronization purposes. To change to use an external clock source, select **CLKSource** and set it to **External** by pressing the menu function key. To change it to **Internal**, press the key again.

When set to **External**, connect a 10 MHz reference signal to the rear BNC terminal labeled **10MHz In**.

Store and Recall

The instrument can easily store or recall instrument settings and arbitrary waveforms from internal memory or an external USB flash drive.

Note: If a USB flash drive is connected to the front port, wait a few seconds after pressing the **Store/Recall** button for the file browser screen to load the flash drive information.

Accessing Store/Recall Menu

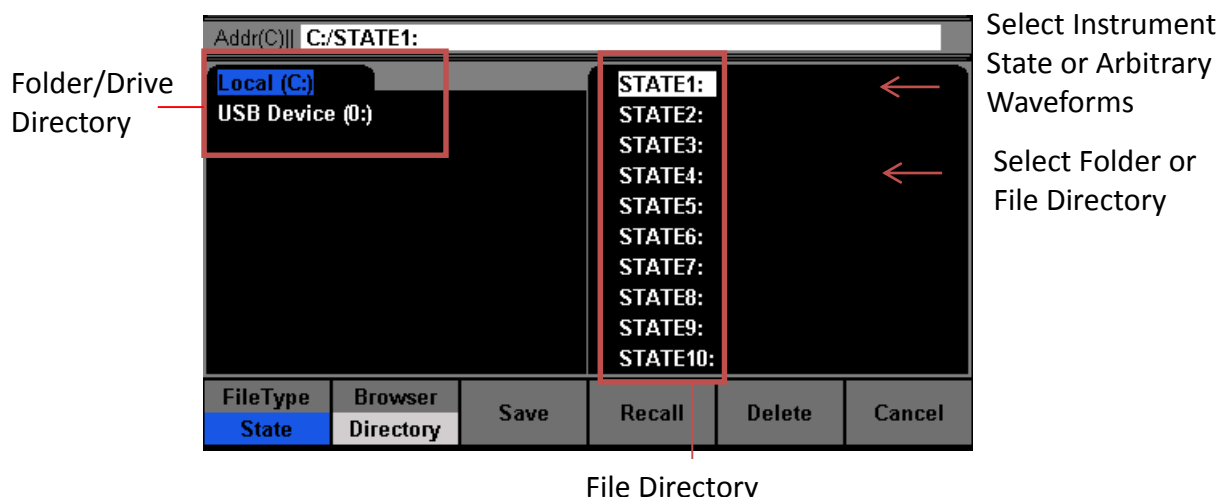

To access the store and recall menu, press the **Utility** button from the front panel, select **More 1 of 2** from the menu, and select **Store/Recall**. The above screen will display.

The left column is the folder or drive directory. Internal storage is labeled as **Local (C:)**. If an external USB flash drive is connected, **USB Device (0:)** will show in the directory.

The right column is the file directory, which lists all the internal storage locations for instrument state as well as arbitrary waveforms. If external USB flash drive is selected from the folder/drive directory, the file directory will show the root folder of the USB flash drive.

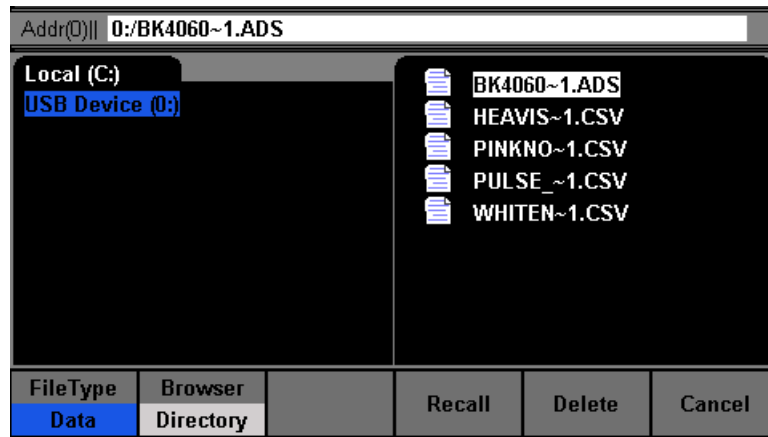

Press the corresponding menu function key to select between **Folder** or **File** under **Browser**. This will select either the folder or drive directory (left column) or the file directory (right column). The selected column will have the selection cursor in white.

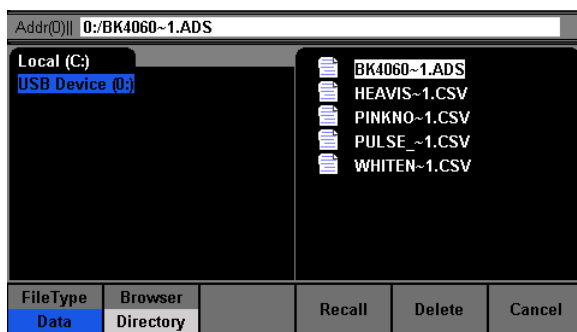

Browse Folder Directory

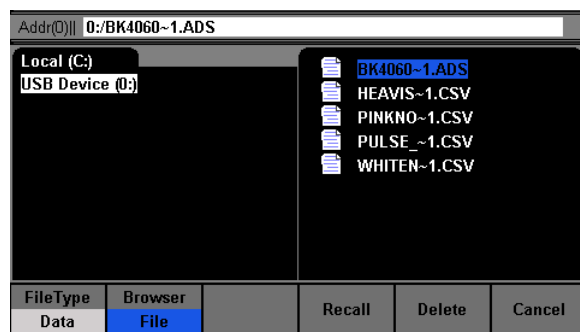

Browse Files

Press the corresponding menu function key to select between **State** or **Data** under **FileType**. Select **State** to show the list of internal instrument states. Select **Data** to show the list of internal arbitrary waveforms.

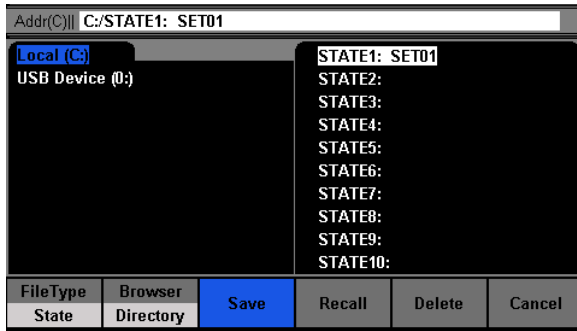

Instrument States List

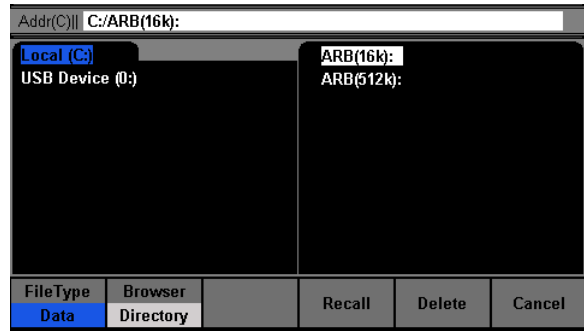

Arbitrary Waveforms List

Use the rotary knob to move the selection cursor between the lists.

Store and Recall Instrument State

Follow the instructions in this section to store and instrument state to internal or external memory.

Store to and Recall from Internal Memory

1. Configure the instrument with all the settings that you want to save, then access the **Store/Recall** menu, as shown previously.
2. From the **Store/Recall** menu, select **Folder** under **Browser** and select **Local (C:)**.
3. Press the menu function key corresponding to **Browser** again to change to **File**.
4. From the menu, change **FileType** to **State**.
5. Use the rotary knob to move the selection cursor and highlight any item (state memory locations) on the list from **STATE1 – STATE 10**.
6. Once selected, press the **Save** option from the menu to store current instrument settings into the selected state memory location.
7. The instrument will prompt to enter a file name. Use the rotary knob or **Up, Down** menu options to change the highlighted selection from the on-screen keyboard to select each character for the file name. Once selected, press **Select** option from the menu to enter the highlighted character. To delete characters, press **Delete** from the menu. To cancel, press **Cancel** from the menu.



8. When finished, select **Save** from the menu. If saved successfully, a “**Your system state has been saved**” message will be shown. Wait a few seconds before the screen returns to the **Store/Recall** main display.
9. Now, the selected state memory location will have a file name next to the **STATE#:**.

To recall stored instrument states:

10. Select **File** under **Browser** from the menu and use the rotary knob to select the state memory location.
11. From the menu, select **Recall** and the instrument settings saved at the selected location will load. If loaded successfully, the following message will be shown: “**Your system state has been read into the generator.**”

Store to and Recall from External USB Drive

1. Configure the instrument with all the settings that you want to save, then access the **Store/Recall** menu, as shown previously.
2. From the **Store/Recall** menu, select **Folder** under **Browser** and select **USB Device (0:)**.
3. From the menu, change **FileType** to **State**.
4. Press the **Save** option from the menu.
5. The screen will prompt to enter a file name. Use the rotary knob or **Up, Down** menu options to change the highlighted selection from the on-screen keyboard to select each character for the file name. Once selected, press **Select** option from the menu to enter the highlighted character. To delete characters, press **Delete** from the menu. To cancel, press **Cancel** from the menu.
6. When finished, select **Save** from the menu. If saved successfully, a “**Your system state has been saved**” message will be shown. Wait a few seconds before the screen returns to the **Store/Recall** main display.
7. The file directory displaying the contents of the USB flash drive will now have a new file with the entered filename with a **.SET** extension. This is the file type used to store instrument states.

To recall stored instrument states, select the **USB Device (0:)** from the folder directory, then use the rotary knob to highlight the saved **.SET** file and select **Recall** from the menu.

Store and Recall Arbitrary Waveforms

Follow the instructions in this section to store and recall arbitrary waveforms to internal or external memory.

Store Arbitrary Waveforms

Note: To store arbitrary waveforms into internal memory or external USB flash drive requires the use of EasyWave software. The software will have an option to load the waveforms into the generator, which will then be stored into the internal memory. Waveforms created in EasyWave can also be saved into a .csv file onto a USB flash drive, which can be loaded into the generator's arbitrary waveform memory.

Recall Arbitrary Waveforms

Follow the steps below to recall internally saved arbitrary waveforms.

1. From the **Store/Recall** menu, select **Folder** under **Browser** and select **Local (C:)**.
2. From the menu, change **FileType** to **Data**. Then, change **Browser** to **File**.
3. Select between **ARB(16k)** or **ARB(512k)** to choose desired waveform length.
4. The list of arbitrary waveform memory locations are listed in a table form.
5. The file name used to load from EasyWave will be listed here if it was transferred successfully.
6. Use the rotary knob to move the selection cursor and select the location with the arbitrary waveform you want to output.
7. Press the **Done** option. If loaded successfully, a "**Your data has been read into the generator**" message will be shown and the instrument will automatically proceed into the arb menu with the selected waveform loaded and shown on display.

Follow the steps below to recall arbitrary waveforms stored in an external USB flash drive.

1. Connect the USB flash drive to the front panel USB port, and a message will appear on the display after a second "**A USB flash drive has been detected.**"
2. Press the **Store/Recall** button and select **Folder** under **Browser** and select **USB Device (0:)**.
3. From the menu, change **FileType** to **Data**. Then, change **Browser** to **File**.
4. Use the rotary knob to move the selection cursor and select the .csv file from the USB flash drive that contains the arbitrary waveform data saved from EasyWave software.
5. Select the **Recall** option from the menu and wait for a few seconds for the instrument to load the data file. Once finished, a message will appear "**Your data has been read. Please choose a memory location.**"

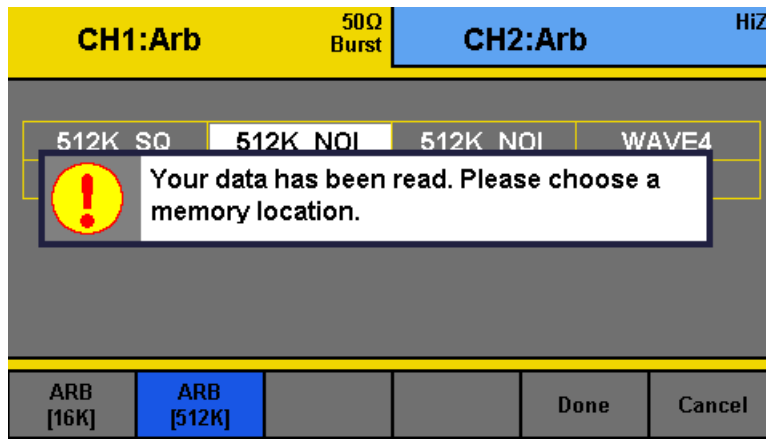

- You will enter a table structure to save your waveform. Use the rotary knob again to move the selection cursor and select any of the arbitrary waveform memory locations listed in the table.

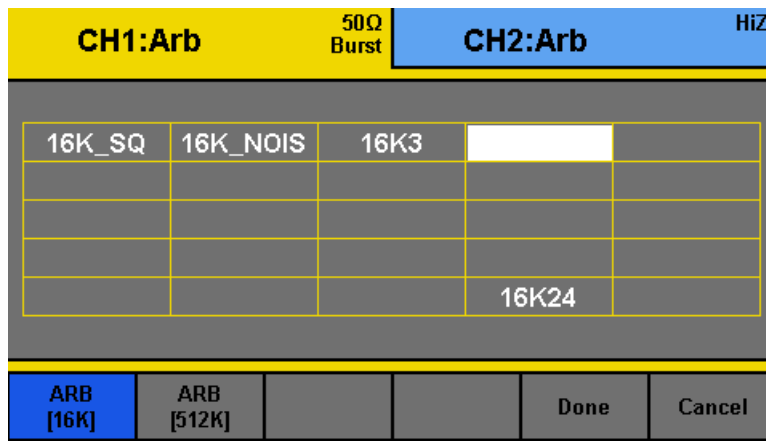

Note: The instrument can only load arbitrary waveforms that are stored into the internal memory, so waveforms that are saved onto an external USB flash drive must be loaded to the internal memory.

- Select **Done** from the menu to transfer the loaded arbitrary waveform data from the external USB flash drive into the selected internal arbitrary waveform memory location.
- The instrument will then automatically go into the arb menu with the selected waveform loaded and shown on display.

Note: If you browse through the internal arbitrary waveform memory locations, you will see the filename that was loaded from the USB flash drive now indicated next to the selected memory location.

Self Test and Adjustment

See section “2.3 Preliminary Check” under Output Check for details.

Check Instrument Information

Press **Utility** and press **More 1 of 2** to go to the second page of the utility menu. Select **EditInfo** to see information about the instrument. You will be able to find the following: **boot up times, firmware version, hardware version, model, and serial number.**

To exit, press any of the menu function keys.

Updating Firmware

When updates are available, users can update the firmware of the instrument by following the steps below.

1. Go to www.bkprecision.com and download the firmware update file. The file format will have a **.ADS** extension.
2. Save the file onto a USB flash drive, then connect the drive into the front USB connector of the instrument.
3. Once the USB drive is detected, press **Utility** and press **More 1 of 2** to go to the second page of the utility menu.
4. Select **Update** option from the menu and the instrument will go into the **Store/Recall** main menu.
5. Select **Browser** and select **Folder**. Then use the rotary knob or the up and down arrow keys to select **USB Device (0:)**. Then select **Browser** again and change it to **File**.
6. On the right column, use the rotary knob to select the **.ADS** firmware file that was saved in the USB flash drive.
7. Then select **Recall** from the menu. Wait a few seconds and the firmware will begin updating the device.
8. When finished, a message will prompt you to restart the generator. At this point, power off the instrument and wait a few seconds, then power it back on.
9. The instrument will now have the updated firmware. You can verify this by checking the instrument information (follow instructions from the previous section to check).

Output Configurations

Select and/or buttons above the output BNC connectors to configure the channel's respective output parameters.

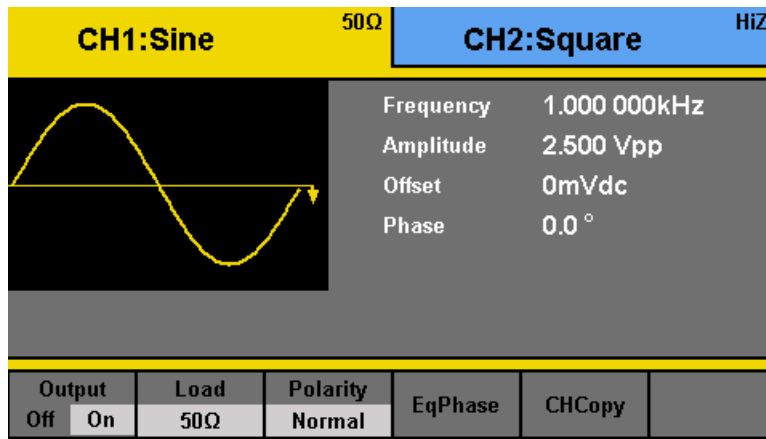

Output State

The output of each channel's state can be enabled or disabled by simply toggling the **Output** option **OFF** or **ON**. When enabled, the respective channel button LED will be lit.

Output Impedance

The output impedance of the instrument can be switched between **50 Ω** and **HighZ** (high impedance). Select the menu function key corresponding to **Load** to toggle between the two settings.

Note: If you are connecting directly into an oscilloscope, note that most scopes have 1 MΩ impedance. In this case, it is best to set the output impedance to HighZ to match the load impedance. However, if your load impedance is 50 Ω, keep output impedance set to 50 Ω to match.

Invert Waveform

The main waveform can be inverted by simply toggling the **Polarity** option from the channel output configuration menu. The corresponding menu function key can be pressed to toggle between **Normal** and **Invert** output. Inverting a waveform will not change the offset.

Equal Phase

The unit can set both channel 1 and channel 2 to be in phase. Select the channel the phase value to keep, then select **EqPhase** and the opposite channel will be in-phase with the selected channel.

Duplicate Channel Parameters (CHCopy)

The unit has an option that can allow quick copying between channel parameters. First, press **CHCopy** option from the channel menu, and the below menu will display.

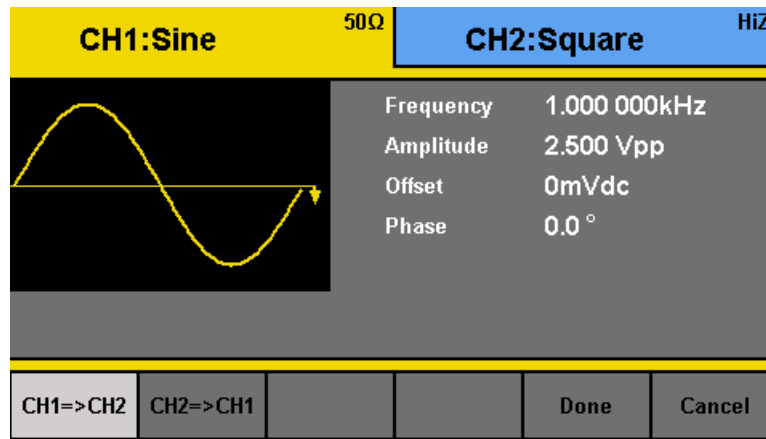

Select **CH1 -> CH2** to copy channel 1's parameter settings into channel 2. Likewise, select **CH2 -> CH1** to copy channel 2's parameter settings into channel 1. After selection, press **Done**, and now both channels are identical with the same parameter settings.

To cancel, select **Cancel**.

3.8 Help System

A built-in help system is available to provide quick references on setting up common output configurations with the generator. To access the system, press the **Help** button from the front panel. The screen below will be displayed:

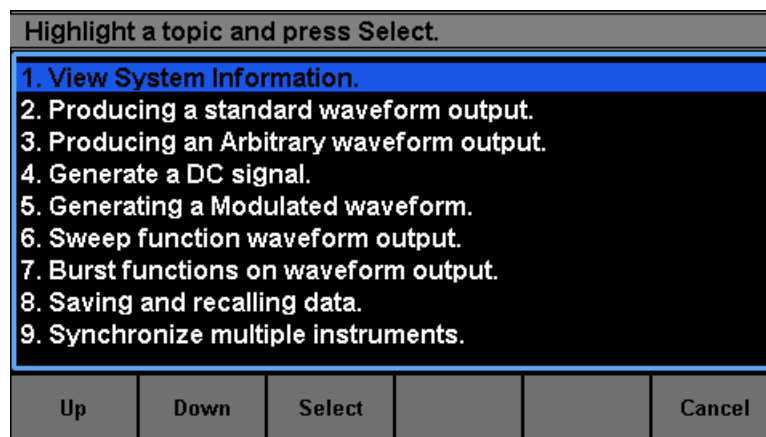

You can use the up and down menu options or the rotary knob to select any of the items listed in the help system as shown above. Once selected (the cursor highlights the selection in blue), push the corresponding menu function key for the **Select** option and the screen will display a description of the selected help item.

When finished, press the **Cancel** option from the menu to go back to the main help menu.

4 Troubleshooting Guide

Below are some frequently asked questions and answers. Please check if any apply to your instrument before contacting B&K Precision.

Q: I cannot power up the generator

- Check that the power cord is securely connected to the AC input and there is live power from your electrical AC outlet.
- Verify that the AC power coming from the mains is the correct voltage. The generator can accept a specific range of AC input voltages. Refer to section “2.1 Input Power Requirements”.

Q: I do not get any output from the output terminals

- Make sure that the CH1 and/or CH2 buttons above BNC connectors are lit. If not, press it once and toggle **Output** option **ON**. The backlight of these **Output** channel buttons indicates that the respective channel’s output is enabled.

Q: I have connected my signal to an oscilloscope, but the amplitude is double of what I set

- This is often because the impedance of the generator is not matched with the oscilloscope. When the generator is set to 50 Ω impedance, connecting it directly to an oscilloscope with a 1 M Ω input impedance will cause this to happen. To eliminate this issue, connect a 50 Ω terminator to the input of the oscilloscope, then connect a BNC cable between the generator and the terminator to have matching impedance. Refer to section “2.2 Output Connections”.

5 Specifications

Note: All specifications apply to the unit after a temperature stabilization time of 15 minutes over an ambient temperature range of 23 °C ± 5 °C. Specifications are subject to change without notice.

Environmental Conditions:

This instrument is designed for indoor use and operated with maximum relative humidity of 90%.

Model	4063	4064	4065
Channels	2		
Frequency Characteristics			
Sine	1 μHz – 80 MHz	1 μHz – 120 MHz	1 μHz – 160 MHz
Square	1 μHz – 40 MHz	1 μHz – 50 MHz	
Triangle, Ramp	1 μHz – 4 MHz		
Pulse	1 μHz – 20 MHz	1 μHz – 30 MHz	1 μHz – 40 MHz
Gaussian Noise (-3 dB)	100 MHz		
Arbitrary	1 μHz – 20 MHz	1 μHz – 30 MHz	1 μHz – 40 MHz
Accuracy	± 2 ppm (1 year)		
Resolution	1 μHz		
Arbitrary Characteristics			
Built-in Waveforms	36		
Waveform Length	Ch1: 16k points only, Ch2: 512k or 16k points		
Vertical Resolution	14 bits		
Sampling Rate	500 MSa/s		
Minimum Rise/Fall Time	6 ns (typical)		
Jitter (cycle-to-cycle)	2 ns (typical)		
Non-volatile memory storage	8 x 512 kpts and 24 x 16 kpts waveforms		
Output Characteristics			
Amplitude Range	For freq ≤ 40 MHz: 1 mVpp – 10 Vpp (50 Ω), 2 mVpp – 20 Vpp (Hi-Z) For freq > 40 MHz to 100 MHz: 1 mVpp – 5 Vpp (50 Ω), 2 mVpp – 10 Vpp (Hi-Z) For freq > 100 MHz to 160 MHz: 1 mVpp – 1.5 Vpp (50 Ω), 2 mVpp – 3 Vpp (Hi-Z)		
Amplitude Resolution	Up to 4 digits		
Amplitude Accuracy (100 kHz sine)	± (0.3 dBm + 1 mVpp)		
Amplitude Flatness (relative to 100 kHz sine, 1 Vpp)	≤ 10 MHz ± 0.2 dB ≤ 80 MHz ± 0.5 dB ≤ 160 MHz ± 0.8 dB		
Cross Talk	< -65 dBc		

Offset Range (DC)	$\pm 5\text{ V}$ into $50\ \Omega$ $\pm 10\text{ V}$ into open circuit
Offset Resolution	Up to 4 digits
Offset Accuracy	$\pm (\text{Offset setting value} * 1\% + 1\text{ mV})$
Output Impedance	$50\ \Omega$, high impedance
Output Protection	Short-circuit protection
Waveform Characteristics	
Harmonic Distortion	DC – 1 MHz, < -54 dBc 1 MHz – 10 MHz, < -46 dBc 10 MHz – 100 MHz, < -35 dBc 100 MHz – 160 MHz, < -26 dBc
Total Harmonic Distortion	DC – 20 kHz at 1 Vpp, < 0.2 %
Spurious (non-harmonic)	DC – 1 MHz, < -70 dBc 1 MHz – 10 MHz, < -65 dBc
Phase Noise	100 kHz offset, - 116 dBc/Hz (typical)
Rise/Fall Time (Square)	< 8 ns (10 % - 90 %) at full amplitude into $50\ \Omega$
Variable Duty Cycle (Square)	For freq $\leq 10\text{ MHz}$: 20% - 80% For freq > 10 MHz to 40 MHz: 40% - 60% For freq > 40 MHz to 50 MHz: 50%
Asymmetry (50 % duty cycle)	1% of period + 5 ns (typical, 1 kHz, 1 Vpp)
Jitter square (cycle-to-cycle)	$\leq 100\text{ ps rms}$ (typical)
Ramp Symmetry	0% - 100%
Linearity	< 0.1 % of peak output
Pulse	
Pulse Width	12 ns minimum, 100 ps resolution, 1,000,000 s max
Rise/Fall Time	6 ns – 6 s ⁽¹⁾ , 100 ps resolution
Duty Cycle	0.0001% to 99.9999%
Overshoot	< 3%
Jitter (pk-pk)	< 100 ps rms (typical)
Burst	
Waveform	Sine, Square, Ramp, Pulse, Arbitrary (except DC)
Type	Cycle (1 – 1,000,000 cycles), Infinite, Gated
Start/Stop Phase	0° – 360°
Internal Period	1 μs – 1000 s $\pm 1\%$
Gated Source	External Trigger
Trigger Source	Internal, External, Manual
Phase Offset	
Range	-360° – 360°
Resolution	0.1°

Trigger Characteristics	
Trigger Input	
Input Level	TTL compatible
Slope	Rising or Falling, selectable
Pulse Width	> 50 ns
Input Impedance	> 5 k Ω , DC coupling
Input Latency	< 380 ns (typical)
Trigger Output	
Voltage Level	TTL compatible
Pulse Width	> 60 ns (typical)
Output Impedance	50 Ω (typical)
Maximum Frequency	1 MHz
Modulation Characteristics	
AM, FM & PM Modulation	
Carrier	Sine, Square, Ramp, Arbitrary (except DC)
Source	Internal, External
Modulation Waveform	Sine, Square, Ramp, Noise, Arbitrary (1 MHz – 50 kHz)
AM Modulation Depth	0 % - 120 %, 0.1 % resolution
FM Frequency Deviation	0 – 0.5 x bandwidth, 1 MHz resolution
PM Phase Deviation	0 – 360 °, 0.1 ° resolution
ASK & FSK Modulation	
Carrier	Sine, Square, Ramp, Arbitrary (except DC)
Source	Internal, External
Modulation Waveform	50 % duty cycle square waveform (1 MHz – 1 MHz)
DSB-AM Modulation	
Carrier	Sine, Square, Ramp, Arbitrary (except DC)
Source	Internal, External
Modulation Waveform	Sine, Square, Ramp, Noise, Arbitrary (1 MHz – 50 kHz)
PWM Modulation	
Source	Internal, External
Modulation Waveform	Sine, Square, Ramp, Arbitrary (except DC)
External Modulation	-4.5 V to 4.5 V (max. width deviation)
Duty Cycle Modulating Frequency	1 MHz – 50 kHz
Sweep Characteristics	
Waveforms	Sine, Square, Ramp, Arbitrary (except DC)
Sweep Shape	Linear or Logarithmic, up or down
Sweep Time	1 ms – 500 s \pm 0.1%
Sweep Trigger	Internal, External, Manual
Inputs and Outputs	
Output Impedance	50 Ω , High impedance

Sync OUT	Voltage Level: TTL compatible Pulse Width: > 50 ns, not adjustable Output Impedance: 50 Ω (typical) Max Frequency: 10 MHz
Modulation In	Voltage Level: ± 5 V for 100% modulation Input Impedance: > 10 kΩ Max. voltage input: + 5 V
External Clock In and Out	Frequency Range: 10 MHz ± 100 Hz, TTL compatible for external unit synchronization
Ext Trig/Gate/FSK/Burst	TTL compatible Max. voltage input: + 5 V
Frequency Counter	
Measurement	Frequency, Period, Positive/Negative pulse width, Duty cycle
Measurement Range	100 mHz – 200 MHz
Frequency Resolution	6 bits
Voltage range (non-modulated signal)	
DC Coupling	DC Offset Range: ± 1.5 VDC 100 mHz – 100 MHz, 50 mVrms - ± 2.5 V 100 MHz – 200 MHz, 100 mVrms - ± 2.5 V
AC Coupling	1 Hz – 200 MHz, 100 mVrms – 5 Vpp
Pulse width/Duty cycle Voltage Range	50 mVrms – 5 Vpp
Input Impedance	1 MΩ
Coupling	AC, DC
Trigger Level Range	-3 V to +1.8 V
General	
AC Input	100 – 240 VAC ± 10%, 50 / 60 Hz ± 5% 100 – 120 VAC ± 10%, 45 – 440 Hz
Power Consumption	30 W max.
Display Resolution	4.3" TFT-LCD Display, 480 x 272
Remote Control Interface	USB/TMC (standard), GPIB (optional)
Storage Memory	10 Instrument settings, 32 Arbitrary waveforms
Dimensions (WxHxD)	261 mm x 105 mm x 344 mm (10.3" x 4.1" x 13.5")
Weight	2.8 kg (6.1 lbs)
Temperature	Operation: 0 °C – 40 °C Storage: -20 °C – 60 °C
Humidity	< 35 °C, ≤ 90 % RH 35 °C – 40 °C, ≤ 60 % RH
Altitude	Operation: Below 3,000 m Storage: Below 15,000 m

⁽¹⁾depending on pulse width

SERVICE INFORMATION

Warranty Service: Please go to the support and service section on our website at www.bkprecision.com to obtain a RMA #. Return the product in the original packaging with proof of purchase to the address below. Clearly state on the RMA the performance problem and return any leads, probes, connectors and accessories that you are using with the device.

Non-Warranty Service: Please go to the support and service section on our website at www.bkprecision.com to obtain a RMA #. Return the product in the original packaging to the address below. Clearly state on the RMA the performance problem and return any leads, probes, connectors and accessories that you are using with the device. Customers not on an open account must include payment in the form of a money order or credit card. For the most current repair charges please refer to the service and support section on our website.

Return all merchandise to B&K Precision Corp. with prepaid shipping. The flat-rate repair charge for Non-Warranty Service does not include return shipping. Return shipping to locations in North America is included for Warranty Service. For overnight shipments and non-North American shipping fees please contact B&K Precision Corp.

B&K Precision Corp.
22820 Savi Ranch Parkway
Yorba Linda, CA 92887
www.bkprecision.com
714-921-9095

Include with the returned instrument your complete return shipping address, contact name, phone number and description of problem.

LIMITED THREE-YEAR WARRANTY

B&K Precision Corp. warrants to the original purchaser that its products and the component parts thereof, will be free from defects in workmanship and materials for a period of **three years** from date of purchase.

B&K Precision Corp. will, without charge, repair or replace, at its option, defective product or component parts. Returned product must be accompanied by proof of the purchase date in the form of a sales receipt.

To help us better serve you, please complete the warranty registration for your new instrument via our website www.bkprecision.com

Exclusions: This warranty does not apply in the event of misuse or abuse of the product or as a result of unauthorized alterations or repairs. The warranty is void if the serial number is altered, defaced or removed.

B&K Precision Corp. shall not be liable for any consequential damages, including without limitation damages resulting from loss of use. Some states do not allow limitations of incidental or consequential damages. So the above limitation or exclusion may not apply to you.

This warranty gives you specific rights and you may have other rights, which vary from state-to-state.

B&K Precision Corp.
22820 Savi Ranch Parkway
Yorba Linda, CA 92887
www.bkprecision.com
714-921-9095

BK PRECISION[®]

22820 Savi Ranch Parkway
Yorba Linda, CA 92887
www.bkprecision.com

© 2014 B&K Precision Corp.

v061114