

**OPERATION AND SERVICE MANUAL**

**HYAMP® III**

**MODEL 3130 GROUND BOND TESTER**

**SERIAL NUMBER**

--	--	--	--	--	--	--

***Model 3130***

***Item 38301***

***Ver 3.07***

© Associated Research, Inc., 2014  
13860 West Laurel Drive  
Lake Forest, Illinois 60045-4546  
U.S.A.

Printed November 07, 2014



# DECLARATION OF CONFORMITY

**Manufacturer:** Associated Research, Inc.  
**Address:** 13860 W. Laurel Dr.  
Lake Forest, IL 60045  
USA  
**Product Name:** HYAMP<sup>®</sup> III Ground Bond Tester  
**Model Number:** 3130

## Conforms to the following Standards:

**Safety:** UL 61010-1:2012, UL 61010-2-030:2012  
CAN/CSA-C22.2 NO. 61010-1-12  
CAN/CSA-C22.2 NO. 61010-2-030-12  
EN 61010-1:2010, EN 61010-2-030:2010  
EN 61010-031:2002+A1  
IEC 61010-1:2010, IEC 61010-2-030:2010  
IEC 61010-31:2002+A1

**EMC:** EN 61326-1:2006,  
(EN 55011:1998/A2:2002 Class A,  
EN 61000-3-2:2006, EN 61000-3-3 :1995/A1:2001/A2:2005  
EN 61000-4-2:1995/A2:2000, EN 61000-4-3:2002,  
EN 61000-4-4:2004, EN 61000-4-5:1995/A1:2000,  
EN 61000-4-6:2003, EN 61000-4-8:1993/A1:2000,  
EN 61000-4-11:2004)

## Supplementary Information

*The product herewith complies with the requirements of the **Low Voltage Directive 2006/95/EC** and the **EMC Directive 2004/108/EC**.*

**Last two digits of the year the CE mark was first affixed: 02**

*The technical file and other documentation are on file with Associated Research, Inc.*

Joseph Guerriero  
President / General Manager  
Associated Research, Inc.  
Lake Forest, Illinois USA  
November 07, 2014

# TABLE OF CONTENTS

<b>1. INTRODUCTION .....</b>	<b>1</b>
1.1. Warranty Policies.....	1
1.2. Safety Symbols.....	3
1.2.1. Product Marking Symbols.....	3
1.2.2. Caution and Warning Symbols.....	3
1.3. Glossary of Terms.....	3
1.4. Safety .....	5
1.4.1. Service and Maintenance .....	5
1.4.2. Test Station.....	6
1.4.3. Test Operator.....	7
1.5. Key Features and Benefits.....	9
<b>2. GETTING STARTED .....</b>	<b>10</b>
2.1. Unpacking and Inspection.....	10
2.1.1. Packaging.....	10
2.1.2. Contents of Carton.....	10
2.1.3. Returning the Instrument for Service or Calibration.....	<b>Error! Bookmark</b>
<b>not defined.</b>	
2.2. Installation.....	12
2.2.1. Work Area.....	12
2.2.2. Power Requirements .....	12
2.2.3. Basic Connections .....	13
2.2.4. Environmental Conditions.....	13
<b>3. SPECIFICATIONS AND CONTROLS .....</b>	<b>15</b>
3.1. HYAMP III Functional Specifications.....	15
3.2. Instrument Controls.....	17
3.2.1. Front Panel Controls.....	17
3.2.2. Rear Panel Controls .....	18
<b>4. PROGRAMMING INSTRUCTIONS .....</b>	<b>20</b>
4.1. Power Up.....	20
4.1.1. Memory, Step and Connected Step Indicator.....	20
4.1.2. Main Menu.....	20
4.1.3. Results, Tests and System Selections .....	21
4.2. System Setup.....	22
4.2.1. System Setup Soft keys .....	23
4.2.2. System Parameters .....	23
4.2.3. Default System Parameters.....	28
4.2.4. Memory, Step, and Default System Parameter Initialization.....	28
4.3. Test Setup .....	28
4.3.1. Test Setup Soft Keys.....	29

4.3.2. Test Parameters .....	29
4.3.3. Default Parameters .....	30
4.3.4. Setting Up a Test.....	30
<b>5. OPERATING INSTRUCTIONS.....</b>	<b>32</b>
5.1. Instrument Connections .....	32
5.1.1. Test Leads.....	32
5.1.2. Adapter Box Connections (Adapter box is sold separately) .....	32
5.1.3. Interlock Connector .....	33
5.2. Performing a Test.....	33
5.3. Perform Tests, Main Menu, and Results Screens .....	33
5.4. Test Metering .....	33
5.5. Results Screens.....	34
5.6. Error Messages .....	34
<b>6. CONNECTION OF REMOTE I/O.....</b>	<b>36</b>
6.1. Remote Signal Outputs .....	36
6.2. Signal Inputs of Remote I/O and Memory Access .....	37
6.3. System 3100, HYAMP III Integrated with HYPOT III.....	41
6.4. System 3100, HYAMP III Integrated with HYPOT III.....	41
<b>7. OPTIONS.....</b>	<b>43</b>
<b>8. INSTRUMENT VERIFICATION .....</b>	<b>50</b>
8.1. Verification Initialization.....	50
8.2. Verification Menu.....	50
<b>9. CALIBRATION PROCEDURE .....</b>	<b>52</b>
9.1. Warranty Requirements .....	52
9.2. Calibration Initialization.....	52
9.2.1. Calibration of Parameters .....	53
9.2.2. Calibration of Ground Bond AC Current.....	53
9.2.3. Calibration of Ground Bond AC Voltage .....	54
<b>10. REPLACEMENT PARTS LIST.....</b>	<b>55</b>

Index is located at the back of the Manual.

## 1. INTRODUCTION

### 1.1. Warranty Policies

Associated Research, Inc., certifies that the instrument listed in this manual meets or exceeds published manufacturing specifications. This instrument was calibrated using standards that are traceable to the National Institute of Standards and Technology (NIST).

Your new instrument is warranted to be free from defects in workmanship and material for a period of (2) year from the date of shipment. You must complete the online registration at <http://www.asresearch.com/support/register/login.aspx> or call 1-800-858-TEST (8378) ext. 0 to register over the phone.

#### 5-Year Program

All Associated Research instruments include the opportunity to extend the standard warranty for up to a period of 5 years. Returning instruments to Associated Research for their annual calibration and inspection will extend the instrument's warranty for an additional year. This warranty is extendable for up to five years and annual returns must be made in succession starting one year after the original purchase date. There are no additional costs for the 5 year product warranty. The only annual costs to the customer are the standard calibration fees and shipping costs. This extended warranty is non-transferable and is offered only to the original purchaser. A return material authorization (RMA) must be obtained from Associated Research, Inc. before returning this instrument for warranty service. Please contact our customer support center at 1-800-858-TEST (8378) to obtain an RMA number. It is important that the instrument is packed properly for safe transport. Please contact our customer support center for proper instructions on packaging. Damages sustained as a result of improper packaging will not be honored. Transportation costs for the return of the instrument for warranty service must be prepaid by the customer. Associated Research, Inc. will assume the return freight costs when returning the instrument to the customer. The return method will be at the discretion of Associated Research, Inc.

#### 3-Year Program

A 3-Year warranty is also available for instruments purchased and used in North America. All costs for this warranty are paid with the initial purchase and include warranty coverage, annual recertification and standard ground return freight for **(3) Years**. However, unlike our 5-Year program, annual recertification and inspection by Associated Research, Inc. is not required.

Except as provided herein, Associated Research, Inc. makes no warranties to the purchaser of this instrument and all other warranties, express or implied (including, without limitation, merchantability or fitness for a particular purpose) are hereby excluded, disclaimed and waived.

### Operator Modifications

Any non-authorized modifications, tampering or physical damage will void this warranty. Elimination of any connections in the earth grounding system or bypassing any safety systems will void this warranty. This warranty does not cover accessories not of Associated Research, Inc. manufacture. Parts used must be parts that are recommended by Associated Research, Inc. as an acceptable specified part. Use of non-authorized parts in the repair of this instrument will void the warranty.

Associated Research, Inc. will not be responsible for any injuries sustained due to unauthorized equipment modifications or use of parts not specified by Associated Research, Inc. Instruments returned to Associated Research, Inc. with unsafe modifications will be returned to their original operating condition at the customer's expense.

## 1.2. Safety Symbols

### 1.2.1. Product Marking Symbols



Product will be marked with this symbol when it is necessary to refer to the operation and service manual in order to prevent injury or equipment damage.



Product will be marked with this symbol when hazardous voltages may be present.



Product will be marked with this symbol at connections that require earth grounding.

### 1.2.2. Caution and Warning Symbols



Calls attention to a procedure, practice, or condition that could possibly cause bodily injury or death.



Calls attention to a procedure, practice, or condition that could possibly cause damage to equipment or permanent loss of data.

## 1.3. Glossary of Terms

(As used in this manual)

**Alternating Current, AC:** Current that reverses direction on a regular basis. Utility power is usually generated in the form of a sinusoid at a frequency of 60 times per second in the United States and 50 times per second in other countries.

**Arc:** A partial momentary breakdown due to the force of a strong electric field on closely spaced conductors, sometimes evidenced by corona or a luminous flashover.

**Breakdown:** The failure of insulation to effectively prevent the flow of current. If the test voltage is gradually raised, breakdown will begin suddenly at a certain voltage level and current flow will not be directly proportional to voltage. Once a breakdown occurs, especially for a period of time, the next gradual application of voltage will often cause a breakdown to begin at a lower voltage.

**Conductor:** A solid or liquid material which permits the flow of electrons. A material which has a volume resistivity of no more than  $10^3 \Omega\text{-cm}$ .

**Current:** The movement of electrons through a conductor. Current is measured in amperes (A), milliamperes (mA), microamperes (uA). Symbol = I

**Dielectric:** An insulating material that is positioned between two conductive materials in such a way that a charge or voltage may appear across the two conductive materials.

**Direct Current, DC:** Current that flows in one direction only. The source of direct current is said to be polarized and has one terminal that is always at a higher potential than the other.

**Frequency:** The number of cycles an AC waveform repeats over time. Usually given in Hertz (Hz).

**Ground:** Refers to the point of low potential in a circuit to which all other voltages are referenced. May or may not be tied to the earth. Also referred to as Earth.

**Hot:** Used to refer to the test lead or output side of an instrument that is at high potential.

**Impedance:** The property of capacitive or inductive items to limit certain frequencies.

**Insulation:** Gas, liquid or solid material which has a volume resistivity of at least  $10^{12}$   $\Omega$ -cm and is used for the purpose of restricting current flow between conductors.

**Leakage:** AC or DC current flow through insulation and over its surfaces. Current flow is directly proportional to voltage. The insulation is thought of as a constant impedance unless breakdown occurs.

**Neutral:** The point of low potential in a circuit to which all other voltages are referenced. Also known as Common.

**Peak Current:** The maximum amplitude of an AC current waveform. For a sinusoid, 1.414 x the RMS value.

**Power:** The amount of work performed by an energy source over time, given in Watts (W).

**PF (Power factor):** Power Factor =  $W/VA$  where  $W$  =Watts (Real Power) and  $VA$  =Volts x Amps (apparent power). It is important to note that the closer the power factor is to "1" the more resistive the DUT is. The closer the power factor is to 0 the more reactive (inductive or capacitive) the DUT is.

**Reactive Current:** The current component due to the reactive impedance of a load. Also called imaginary current.

**Real Current:** The current component due to the resistance of a load.

**Resistance:** The property of a substance that impedes current and results in the dissipation of power in the form of heat. The practical unit of resistance is the *ohm* ( $\Omega$ ). Symbol = **R**

**Return:** The path by which current returns to a source.

**RMS:** The Root Mean Squared value of a voltage or current waveform. An RMS waveform delivers the same amount of energy to a load as a DC waveform of the same value. For a sinusoid, the RMS value is .707 x the peak value.

**Total Current:** The vector sum of the real current component and the reactive current component produced by an applied voltage.

**VA:** A rating of instantaneous power found by multiplying an instrument's maximum output current by its maximum output voltage.

**Voltage:** The force which causes current through an electrical conductor, given in volts (V).  
Symbol = V

## 1.4. Safety

This product and its related documentation must be reviewed for familiarization with safety markings and instructions before operation.

This product is a Safety Class I instrument (provided with a protective earth terminal). Before applying power verify that the instrument is set to the correct line voltage (115 or 230) and the correct fuse is installed.

This product carries an NRTL (Nationally Recognized Testing Laboratory) and comes equipped with an audible and visual failure indicator.

### WARNING

The HYAMP III produces voltages and currents that can cause **harmful or fatal electric shock**. To prevent accidental injury or death, these safety procedures must be strictly observed when handling and using the test instrument.

### 1.4.1. Service and Maintenance

#### User Service

To prevent electric shock do not remove the instrument cover. There are no internal user serviceable parts. Routine maintenance or cleaning of internal parts is not necessary. Avoid the use of cleaning agents or chemicals on the instrument, as some chemicals may damage plastic parts or lettering. Any external cleaning should be done with a clean, dry or slightly damp cloth. Schematics, when provided, are for reference only. Refer servicing and certification to an Associated Research, Inc. authorized service center.

### SAFETY

This instrument meets UL requirements for audible and visual failure indication.

ASSOCIATED RESEARCH, INC.  
13860 WEST LAUREL DRIVE  
LAKE FOREST, IL 60045-4546 U.S.A.

PHONE: 1 (847) 367-4077  
**1 (800) 858-TEST (8378)**  
FAX: 1 (847) 367-4080  
E-MAIL: [info@asresearch.com](mailto:info@asresearch.com)

#### Service Interval

Associated Research, Inc. will not be held liable for injuries suffered if the instrument is not properly maintained and safety checked annually. See section **1.1. Warranty Policies** for more information.

## 1.4.2. Test Station

### Location

Select an area away from the mainstream of activity where employees do not walk while performing their normal duties. If this is not practical because of production line flow, then the area should be roped off and marked for **HIGH VOLTAGE TESTING**. No employees other than test operators should be allowed inside.

If benches are placed back-to-back, be especially careful about the use of the bench opposite the test station. Signs should be posted: **“DANGER – HIGH VOLTAGE TEST IN PROGRESS – UNAUTHORIZED PERSONNEL KEEP AWAY.”**

### Work Area

When possible, use the instrument on a non-conducting table or workbench. If you cannot avoid using a conductive surface, be certain that it is connected to a good earth ground and the high voltage connection is insulated from the grounded surface.

There should not be any metal in the work area between the operator and the location where products being tested will be positioned. Any other metal in the work area should be connected to a good ground, never left “floating”.

Keep the area clean and uncluttered. All test equipment and unnecessary test leads should be removed from the test bench and put away. It should be apparent to both the operator and to any observers which product is under test, which product is waiting to be tested and which product has already been tested.

### Power

Power to the test station should be arranged so that it can be shut off by one prominently marked switch located at the entrance to the test area. In case of an emergency, anyone should be able to cut off the power before entering the test area to offer assistance.

### More Information

For more information on setting up a safe work station, please visit the Events and Training section of our website at <http://www.asresearch.com/events-training/Default.aspx>

#### ESD TESTING

Electrical safety tests should not be performed in or around ESD testing areas. ESD methods should not be employed during electrical safety testing, as this could cause a hazardous condition for equipment and test operators.

### 1.4.3. Test Operator

#### WARNING

This instrument generates voltages and currents that can cause **harmful or fatal electric shock** and must only be operated by a skilled worker trained in its use. **The operator should understand the electrical fundamentals of voltage, current, and resistance.**

#### WARNING

**DO NOT TOUCH THE DEVICE UNDER TEST, TEST LEADS, ALLIGATOR CLIP, OR CLIP INSULATOR ONCE THE TEST HAS BEEN STARTED.**

#### WARNING

**DO NOT TOUCH THE FRONT PANEL WHEN TESTING OR AFTER A MALFUNCTION HAS OCCURRED.**

#### Rules

Operators should be thoroughly trained to follow all national safety standard guidelines for electrical safety testing in the workplace. Defeating any safety system should be considered a serious offense with severe penalties. Allowing unauthorized personnel in the area during a test should also be dealt with as a serious offense. Test operators should be familiar with methods to properly discharge a device under test in case test leads become disconnected during testing.

Refer to the following standards for more information:

- NFPA 70E
- OSHA 1910 subpart (S)
- EN50191

#### Dress

Operators should not wear jewelry that could accidentally complete a circuit.

#### WARNING

ESD protocols should not be observed while

performing electrical safety tests. Intentionally grounding the test operator could lead to a **harmful or fatal electric shock**.

#### Medical Restrictions

Personnel with heart ailments or devices such as pacemakers should be informed that the voltages and

#### KEY SAFETY POINTS TO REMEMBER

- Keep unqualified and unauthorized personnel away from the test area.
- Arrange the test station in a safe and orderly manner.
- In case of any problem, turn off the high voltage first.

currents generated by the instrument are very dangerous. If contacted, the instrument may cause heart-related problems. Please have the test operator consult a physician for recommendations.

## 1.5. Key Features and Benefits: HYAMP III

<b>THE FIRST MANUAL GROUND BOND INSTRUMENT WITH AN ENHANCED GRAPHIC LCD</b>	Provides the operator with an easy-to-use interface, eliminating the need to decipher cryptic abbreviations. The graphic display makes testing safer, easier and more reliable than ever before.
<b>SECURITY ACCESS</b>	Limit user access so that only authorized personnel with a security code can change test parameters.
<b>STORAGE OF UP TO 10 DIFFERENT TEST PROGRAMS</b>	Store test parameters and quickly recall them for each of the different products that need to be tested. Memories can also be linked to run multi-step tests.
<b>INTERCONNECTION WITH HYPOT III</b>	Connect a HYAMP III and a Hypot III to form a complete test system. The test system can be configured to perform sequential Ground Bond and Dielectric Withstand tests, or run both simultaneously.
<b>FOUR WIRE MEASUREMENT (KELVIN METHOD) AND MILLIOHM OFFSET CAPABILITY</b>	The Kelvin four wire measurement technique eliminates test lead resistance. The milliohm offset function allows for the use of longer test leads without compromising the test results.
<b>PLC REMOTE INPUTS AND OUTPUTS</b>	Two standard 9 pin interfaces provide inputs and outputs for simple PLC relay control. Outputs include: PASS, FAIL, RESET and TEST IN PROCESS signals. Inputs include: TEST, INTERLOCK, RESET and remote recall of MEMORY 1, 2 and 3.
<b>WITHSTAND PROCESSING INDICATOR</b>	As a safety precaution, the enhanced graphic LCD indicates when the high voltage from the Hypot III is being applied to the device under test
<b>SOFTWARE CALIBRATION CONTROL</b>	HYAMP III can be completely calibrated without removing any covers and exposing the technician to hazardous voltages.
<b>NO LOAD SETUP OF OUTPUT CURRENT</b>	Set output current parameters without activating the output.

## 2. GETTING STARTED

### Introduction

This section contains information for the unpacking, inspection, preparation and storage of your Associated Research, Inc., product.

### 2.1. Unpacking and Inspection

#### 2.1.1. Packaging

Your instrument was shipped in a custom foam insulated container. If the shipping carton is damaged, inspect the contents for visible damage such as dents, scratches or a broken display. If the instrument is damaged, notify the carrier and Associated Research, Inc.'s customer support department. **Please save the shipping carton and packing material for the carrier's inspection.** Our customer support department will assist you in the repair or replacement of your instrument. Please do not return your product without first notifying us and receiving an RMA (return material authorization) number. To receive an RMA number, please contact our customer support department at 1-800-858-TEST (8378).

#### 2.1.2. Contents of the Carton

Inside the carton should be the following:

DESCRIPTION	AR PART NUMBER
HYAMP III Instrument	3130
Cable ASSY High Current Output	05002D-24
Cable ASSY High Current Return	05002D-37
Fuse	37780, 6.3 Amp, slow-blow 250VAC
Line Cord	33189 Standard
Interlock Connector	38075

### **WARNING**

Only accessories that meet the manufacturer's specifications shall be used.



## 2.2. Installation

### 2.2.1. Work Area

#### **WARNING**

Locate a suitable testing area and be sure you have read all safety instructions for the operation of the instrument and suggestions on the test area setup in section **1.4. Safety**. Make sure the work area you choose has a three-prong grounded outlet capable of supplying the necessary input current to the power source. Be sure the outlet has been tested for proper wiring before connecting the instrument to it.

#### **WARNING**

The mains plug is used as the disconnecting device and shall remain readily operable. The socket-outlet shall be installed near the equipment and shall be easily accessible.

### 2.2.2. Power Requirements

This instrument requires a power source of either 115 volts AC  $\pm 10\%$ , 50/60 Hz single phase or 230 volts AC  $\pm 10\%$ , 50/60 Hz single phase. Before applying power verify that the instrument is set to the correct line voltage (115 or 230 volts). Adjust the voltage select switch to 115 for use with a 115 volt input. Adjust the voltage select switch to 230 for use with a 230 volt input. See section **3.2.2. Rear Panel Controls** for an image of the rear panel.

#### **CAUTION**

Do not replace the power supply cord with an improperly rated cord. For North American: A UL listed and CSA labeled power cord must be used with the instrument in the United States and Canada. The power cord must include a NEMA5-15 style male plug, SVT or SJT cord sets, and be rated for at least 125VAC, 10A, number 16 gauge (or 125VAC, 15A, number 14 gauge) wire or larger, and the length of the cord does not exceed 2 m must be used. For European: A certified power supply cord not lighter than light PVC sheathed flexible cord according to IEC 60227, designation H03 VV-F or H03 VVH2-F (for equipment mass not exceeding 3 kg), or H05 VV-F or H05 VVH2-F2 (for equipment mass exceeding 3 kg), and be rated for at least 3G 0.75 mm<sup>2</sup> (for rated current up to 10 A) or 3G 1.0mm<sup>2</sup> (for rated current over 10 A up to 16 A) wire or larger, and the length of the cord does not exceed 2 m must be used.

#### **CAUTION**

Do not switch the line voltage selector switch located on the rear panel while the instrument is on or operating. This may cause internal damage and represents a safety risk to the operator.

#### **WARNING**

The HYAMP III must be connected to a good ground. Be certain that the power wiring is properly polarized and that the proper low resistance bonding to ground is in place.

### 2.2.3. Basic Connections

#### Power Cable

The instrument is shipped with a line cord containing a protective earth ground. When the line cord is connected to an appropriate AC power source the cable will connect the chassis to earth ground.

**WARNING**

The main plug shall only be inserted in a socket outlet with a protective ground (earth) contact. This protective ground **must not be defeated** by the use of an extension cord without a protective conductor.

#### Return Connection

When the instrument's return is grounded, any internal and external stray leakage will be monitored due to currents that flow from high voltage to earth ground (such as from high voltage to the chassis of the instrument). These currents are inherent and will cause errors when trying to monitor very low leakage currents in the microamp range.

The output power supplies of this instrument are referenced directly to earth ground. Any conductor that completes a path between the high voltage and earth ground will form a completed circuit.

### 2.2.4. Environmental Conditions

This equipment is intended for indoor use only. The equipment has been evaluated according to Installation Category II and Pollution Degree 2 as specified in IEC 664.

This instrument may be operated in environments with the following limits:

Temperature.....	41° - 104° F (5° - 40°C)
Relative humidity.....	0 – 80%
Altitude.....	6560 feet (2,000 meters)

**WARNING**

Do not block any ventilation openings to prevent over heating of the equipment. Keep the ventilation slits uncovered during operation. Failure to do so could cause the instrument to overheat and may damage internal components.

#### Storage and Shipping Environment

This instrument may be stored or shipped in environments with the following limits:

Temperature.....	-40° - 167° F (-40° - 75°C)
Altitude.....	50,000 feet (15,240 meters)

The instrument should also be protected against temperature extremes that may cause condensation within the instrument.

**CAUTION**

Failure to operate this instrument within the specified conditions could result in damage.

If the instrument is used in a manner not specified by the manufacturer, the protection provided by the instrument may be impaired.

### **More Information**

For more information on test operator and workstation safety please visit the Events and Training section of our website at <http://www.asresearch.com/events-training/Default.aspx>

### 3. SPECIFICATIONS AND CONTROLS

#### 3.1. HYAMP III Functional Specifications

INPUT		
Voltage	115/230 VAC $\pm$ 10%, user selectable	
Frequency	50/60 Hz $\pm$ 5%	
Fuse	6.3 Amp, slow-blow 250 VAC	
TEST MODE		
Output Rating	Current:	1.00 – 30.00 Amps AC
	Resolution:	0.01 Amp/step
	Regulation:	$\pm$ (2% of setting + 0.02 Amps)
	Voltage:	6 Volts AC, fixed
Output Frequency	Range:	50 / 60 Hz, user selectable
Dwell Time Setting	Range:	0 and 0.5 – 999.9 seconds, 0 for continuous running
	Resolution:	0.1 second/step
	Accuracy:	$\pm$ (0.1% of setting + 0.05 seconds)
Maximum Limit	Range:	0 – 120 m $\Omega$ for 1 – 30 Amps 0 – 510 m $\Omega$ for 1 – 10 Amps
	Resolution:	1 m $\Omega$ /step
	Accuracy:	$\pm$ (2% of setting + 2 m $\Omega$ )
	Resolution:	1 m $\Omega$ /step
Minimum Limit	Range:	0 – 120 m $\Omega$ for 1 – 30 Amps 0 – 510 m $\Omega$ for 1 – 10 Amps
	Resolution:	1 m $\Omega$ /step
	Accuracy:	$\pm$ (2% of setting + 2 m $\Omega$ )
	Resolution:	1 m $\Omega$ /step
Offset Capability	Range:	0 – 100 m $\Omega$
	Resolution:	1 m $\Omega$ /step
	Accuracy:	$\pm$ (2% of setting + 2 m $\Omega$ )
Current Display	Range:	0.00 – 30.00 Amps
	Resolution:	0.01 Amp/step
	Accuracy:	$\pm$ (3% of reading + 0.03 Amps)
Ohmmeter Display	Range:	0 – 510 m $\Omega$
	Resolution:	1 m $\Omega$ /step
	Accuracy:	$\pm$ (2% of reading + 2 m $\Omega$ )
Timer Display	Range:	0.0 – 999.9 seconds
	Resolution:	0.1 seconds/step
	Accuracy:	$\pm$ (0.1% of reading + 0.05 seconds)

GENERAL	
Remote Control And Signal Output	The following input and output signals are provided through two 9 pin D type connectors; 1. Remote control: Test, Reset, Interlock, and Withstand Processing. 2. Remote recall of memory program #1, #2 and #3. 3. Outputs: Pass, Fail, Test-in-Process, Start Out, and Reset Out.
Program Memory	10 Memories, 3 steps per memory, all steps within a memory are linkable.
Security	Key Lock capability to avoid unauthorized access to all test parameters. Memory Lock capability to avoid unauthorized access to memory locations.
Verification System	Built-in software driven verification menu to test fault detection circuits.
Display	128 x 64 dot resolution with front panel contrast setting.
Alarm Volume Setting	Front panel adjustable volume setting with 10 set points.
Line Cord	Detachable 6 ft. (1.80m) power cable terminated in a three prong grounding plug.
Mechanical	Tilt up front feet. Dimensions: (W x H x D) 8.5 x 4.0 x 15.5 in. (216 x 103 x 390 mm) includes feet. Weight: 19.15 lbs. (8.7 Kgs)
Environmental	Operating Temperature: 32° - 104°F (0° - 40°C) Relative Humidity - 0 to 80%
Calibration	Traceable to National Institute of Standards and Technology (NIST). Calibration controlled by software. Adjustments are made through front panel keypad in a restricted access calibration mode. Calibration information stored in non-volatile memory.

## 3.2. Instrument Controls

### 3.2.1. Front Panel Controls

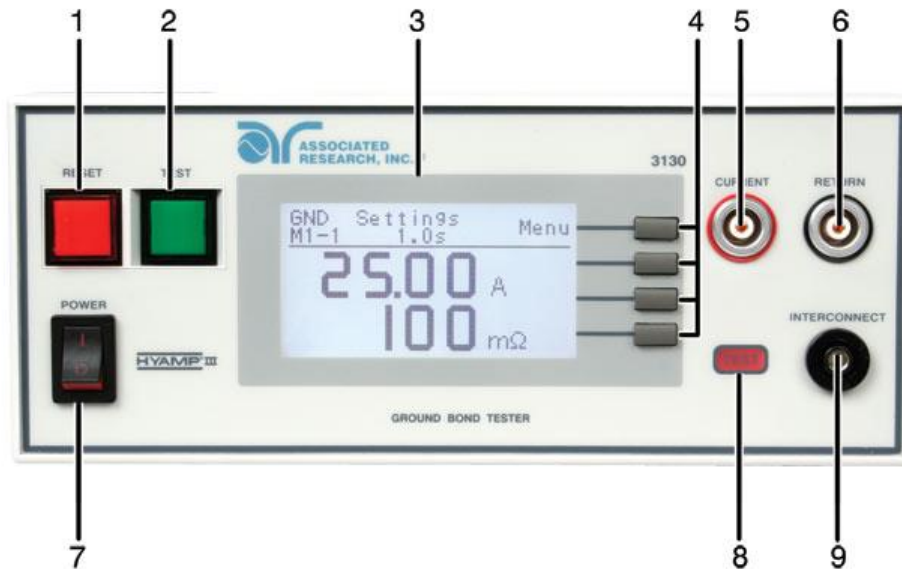

1. **RESET BUTTON:** Momentary contact switch used to reset the instrument. If a failure condition occurs during a test, you will need to reset the system to shut off the alarm and signal the system that you are aware of a failure condition. The reset button must be pressed before you can proceed to the next test or change any of the set-up parameters. This switch also serves as an abort signal to stop any test in progress controlled by the HYAMP III.
2. **TEST BUTTON:** Momentary contact switch used to start tests. Press the green button to activate the test that is set up in the test buffer shown on the display.
3. **GRAPHIC LCD:** 128 X 64 Monographic LCD.
4. **SOFT KEYS:** Multifunction parameter selection keys. Keys used to select screens and change parameters.
5. **CURRENT OUTPUT JACK:** Connector used to attach the Current test lead, adapter box, or test fixture to the instrument.
6. **RETURN OUTPUT JACK:** Connector used to attach the Return test lead, adapter box, or test fixture to the instrument.
7. **POWER SWITCH:** Rocker style power switch with international ON ( | ) and OFF ( 0 ) markings.

8. **TEST LED INDICATOR:** This red indicator flashes to warn the operator that voltage or current is present at the output terminal, and a test is in process.
9. **INTERCONNECT JACK:** Connector used to attach the return lead from the Hipot tester when performing both Hipot and Ground Bond tests on the same test item.

### 3.2.2. Rear Panel Controls

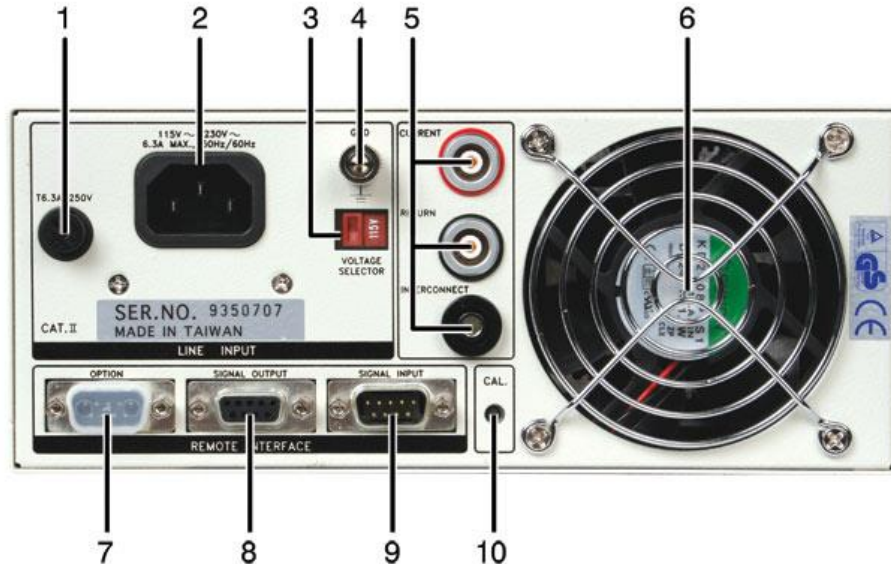

1. **FUSE RECEPTACLE:** To change the fuse, unplug the power (mains) cord and turn the fuse receptacle counter-clockwise. The fuse compartment will be exposed. Please replace the fuse with one of the proper rating.
2. **INPUT POWER RECEPTACLE:** Standard IEC 320 connector for connection to a standard NEMA style line power (mains) cord.
3. **INPUT POWER SWITCH:** Line voltage selection is set by the position of the switch. In the left position it is set for 115 volt operation, in the right position it is set for 230 volt operation.
4. **CHASSIS GROUND (EARTH) TERMINAL:** This terminal should be connected to a good earth ground before operation.
5. **REAR PANEL OUTPUT CONNECTORS:** These connectors are in parallel with the front panel connectors.
6. **THERMAL COOLING FAN:** Full time cooling fan.
7. **OPTION CONNECTOR:** Used with Option 05 External RS-232 Converter.

- 8. REMOTE SIGNAL OUTPUT:** 9-Pin D subminiature female connector for monitoring PASS, FAIL, PROCESSING, and RESET output relay signals.
- 9. REMOTE SIGNAL INPUT:** 9-Pin D subminiature male connector for remote control of TEST, RESET, and INTERLOCK functions, as well as remote program memory selection and withstand processing input.
- 10. CALIBRATION BUTTON:** To put the instrument into the calibration mode, push this button and turn on the POWER switch simultaneously.

## 4. PROGRAMMING INSTRUCTIONS

### 4.1. Power Up

The HYAMP III automatically defaults to the Perform Tests screen upon power up. The Perform Tests screen will appear as follows:



The Perform Tests screen is the main operational screen of instrument. From this screen, all test parameters are monitored while the test is being performed. For more information refer to section **5.2. Perform Tests, Main Menu, and Results Screens**

#### 4.1.1. Memory, Step, and Connected Step Indicator

When in the Perform Tests screen, the Hyamp III will indicate the current memory location (M0–M9) and step number (1-3) in the upper-left part of the screen (i.e. M3-2).

The connected step indicator is an underscore symbol located directly next to the memory and test step number (i.e. M4-2\_) and only will be displayed when the Connect function has been turned ON.

- **NOTE:** There are only 3 programmable test steps per memory location. Step 3 of any memory location cannot be connected to another step.

#### 4.1.2. Main Menu

From the Perform Tests screen, press the “Menu” soft key.



The Main Menu will now be displayed. From the Main Menu screen, three software controls may be accessed: Menu, Memory and Step. Pressing the “Exit” soft key at any time will return you to the Perform Tests screen.

### Menu

Pressing the “Menu” soft key from the Main Menu will display the Results, Test and System selections. Please refer to section **5.2.3. Results, Test, and System Selections**.

### Memory

The HYAMP III has 10, 3-step programmable memory locations (M0-M9). Press the “Memory” soft key to increment the instrument to the desired memory location. As the “Memory” soft key is pressed, the parameters of the selected memory location are automatically loaded into the instrument.

### Step

Each of the 10 memory locations in HYAMP III has 3 programmable test steps that may be connected together to create a multi-step test sequence. Press the “Step” soft key to increment the test step number.

#### 4.1.3. Results, Tests and System Selections

From the Main Menu, press the “Menu” soft key.

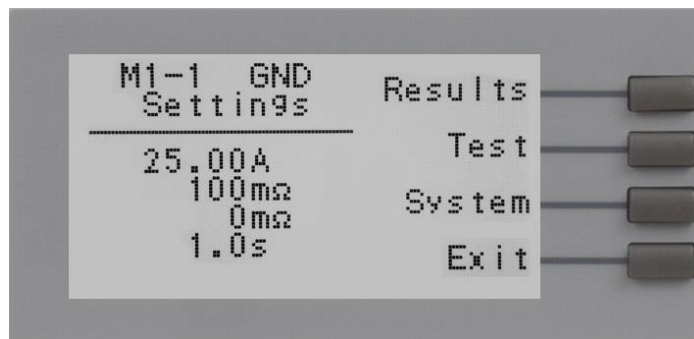

From this screen, three software controls may be accessed: Results, Test and System. Pressing the “Exit” soft key at any time will return you to the Main Menu screen.

### Results

Pressing the “Results” soft key from this menu will allow you to review the test results of the last test performed. An example of a Results screen is shown below.

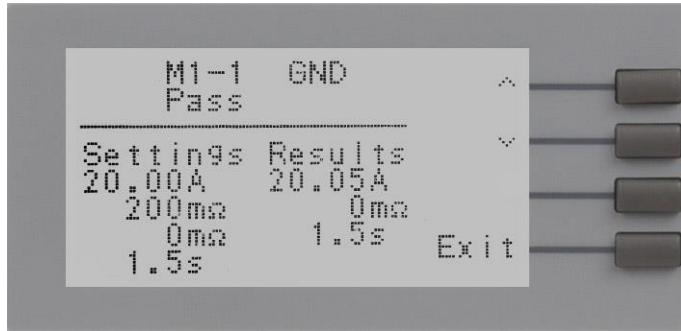

### Test

Pressing the “Test” soft key from this menu will allow you to access the Parameter Review screen. For specific instructions for reviewing and editing test parameters, refer to section **4.3. Test Parameters**.

### System

Pressing the “System” soft key from this menu will allow you to access the Setup System screen. For specific instructions for editing system parameters, refer to section **4.2. System Setup**.

## 4.2. System Setup

1. From the Perform Tests screen, press the “Menu” soft key. The Main Menu screen will now be displayed.
2. From the Main Menu screen, press the “Menu” soft key. Results, Test and System selections will now be displayed.
3. From this screen, press the “System” soft key. The Setup System Menu will now be displayed.

From the Setup System screen, fourteen different hardware and software controls may be accessed: PLC Remote, Single Step, Alarm, Contrast, Results, Lock, Mem Lock, Hipot Start, Cal-Alert, Cal Date, Cal Due, Alert, Date, and Time. Pressing the “Exit” soft key at any time will save all parameters and return to the Perform Tests screen.

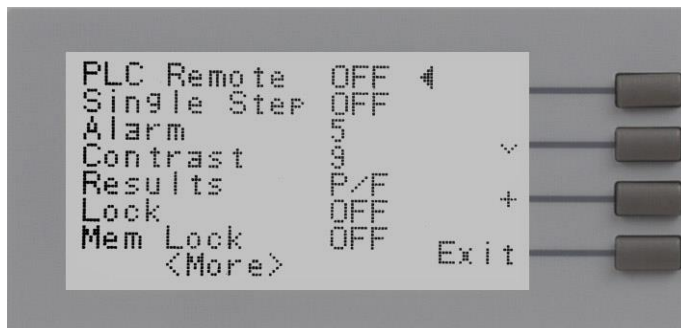

### 4.2.1. System Setup Soft Keys

#### Directional soft keys $\wedge, \vee, >$

The “ $\wedge, \vee, >$ ” soft keys are used to scroll the cursor to the different system parameters.

#### + key

The “+” soft key is used to increase numerical values or toggle settings ON and OFF.

#### Exit key

The “Exit” soft key is used to save the new system parameters and return to the Perform Tests screen.

### 4.2.2. System Parameters

Use the directional soft keys, “ $\vee, \wedge, >$ ”, to navigate the system parameters during reviewing and editing. The directional soft keys will change depending on which parameter the cursor is pointing to.

#### PLC Remote

When the PLC remote is turned ON the front panel TEST button is disabled and a test may only be started through the rear panel I/O. If you attempt to start a test from the TEST button on the front panel when the PLC Remote function is turned ON, a pop-up message will be displayed. The pop-up message will appear as follows:

#### DID YOU KNOW?

You can control your Associated Research, Inc. instrument using basic PLC inputs and outputs. Execute tests and read PASS/FAIL conditions remotely, select memory locations, or set up a safe work station by using an interlocked enclosure.



Refer to the section **6. Connection of Remote I/O** for more details.

#### Single Step

This function is used to temporarily override the automatic connection feature. When the Single Step function is ON the instrument will pause after each test step is completed. To continue the test sequence, press the TEST button to execute the next

connected test step. Each time the TEST button is pressed the next connected test step will execute. If you press the RESET button before completing all connected test steps, it will return you to the original starting test step. If a step fails and you wish to continue to the next test step press TEST.

### Alarm Volume

The numbers 0 through 9 correspond to different volume settings, 0 meaning the volume is OFF and 9 meaning the volume is at the loudest setting. After the “+” soft key is pressed a momentary alarm chirp will occur to indicate the volume of the new setting.

### LCD Contrast

The numbers 0 through 9 correspond to the different contrast settings, 0 meaning the lightest color of displayed characters and 9 meaning the darkest color of displayed characters. After the “+” soft key is pressed the display will automatically adjust to the new display setting.

### Results

Selects the type of results you would prefer to have displayed at the end of a test or sequence of connected test steps. The available selections are: All, P/F and Last.

When All is selected, a Results Summary screen will be displayed at the end of the test or sequence of connected test steps displaying the results of all of the test steps. The Results Summary screen will appear as follows:

### DID YOU KNOW?

You can learn to use your Hyamp III online with our Hyamp III Virtual Tour. Check it out at:

<http://www.asresearch.com/support/virtual-tour.aspx>

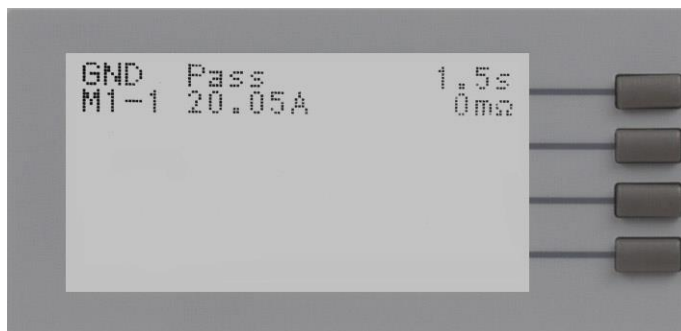

When P/F is selected, a Pass or Fail screen will be displayed at the end of the test. The Pass and Fail screens will appear as follows:

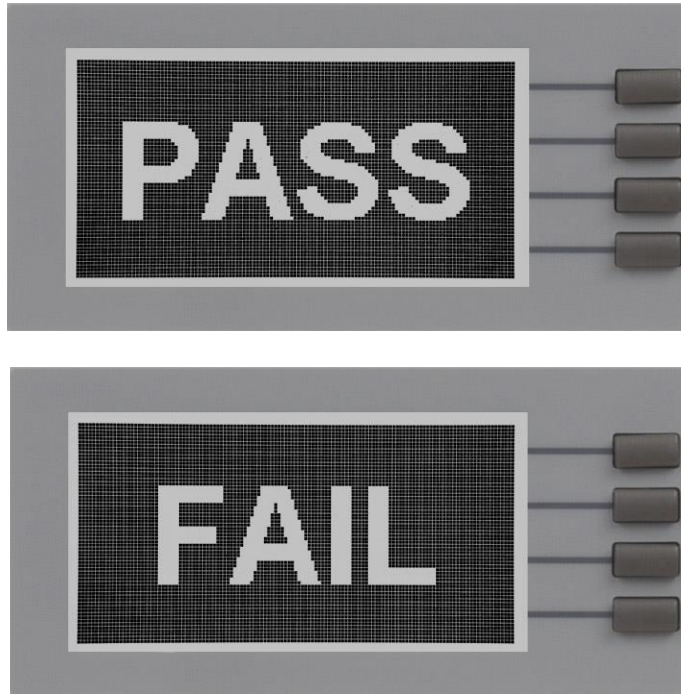

When P/F is selected, it is not possible to see the test results directly at the end of the test. In order to review the test results refer to section **4.2.3. Reviewing Test Results**.

When Last is selected, the results of the last test step performed will be displayed on the Perform Tests screen. There will not be a change in appearance or special screen displayed in this mode.

### **Lock**

Turning Lock ON restricts access to parameter and system settings. The level of security is determined by the Mem Lock function.

### **Mem Lock**

Mem Lock is a sub-function of the Lock setting. In order for the Mem Lock function to work, the Lock must first be turned ON. Turning the Mem Lock OFF will allow the user to access all available memory locations but restricts access to memory and step editing capabilities. Turning the Mem Lock ON will allow the user to only run the currently loaded memory.

### **Disabling Lock**

Once the Lock function is activated, a special procedure is required to defeat the security. To defeat the security press the top soft key while powering up the instrument. Now you may access the system menu and turn the security function OFF.

### **Hipot Start**

Scroll the cursor to the Hipot Start parameter using the directional soft keys. You may toggle the selection between G→W and G + W by pressing the “+” soft key.

The Hipot Start parameter is only used when connecting the HYAMP III with an Associated Research Hipot tester. If G→W is selected, the Hipot test will run after the HYAMP III has completed its test. If G + W is selected, the Hipot test will run at the same time as the HYAMP III.

The Hipot Start parameter directly controls the Start Output relay. Running in the G→W mode will momentarily close the Start Output relay at the end of the HYAMP III test. Running in the G + W mode will momentarily close the Start Output relay at the start of the HYAMP III test.

### **Cal-Alert (Calibration Alert)**

The Cal-Alert feature alerts the user that the instrument is due for calibration. Turning this parameter ON will activate the Cal-Alert function and when the date matches the Alert Date, the instrument will display the Cal-Alert warning screen upon power up. If the “Show this screen again?” function has been turned OFF at the Cal-Alert Warning screen, this parameter will automatically be set to OFF.

### **Cal Date(Calibration Date)**

Cal Date is a non-editable parameter that indicates the last date that calibration was performed on the instrument. This parameter is updated at the time of calibration.

### **Cal Due (Calibration Due Date)**

After a calibration is performed, the Cal Due Date is automatically set for 1 year after the calibration date. This parameter may be overwritten to any date desired. Within the Cal Due Date parameter are three separate fields, month, day, and year. Use the “>” soft key to select the field within the date you want to edit then use the “+” soft key to change the numeric value. Once you change the value it is automatically stored.

- **NOTE:** It is recommended that calibration should be performed at least once a year.

### **Alert (Alert Date)**

The Alert Date is like an alarm clock that will warn you in advance of the actual Calibration Due Date. After a calibration is performed, the Alert Date is automatically set for 11 months after the calibration date. For example, if the calibration is performed on 12/15/2002 the Alert Date will automatically be set to 11/15/2003.

This parameter may be overwritten to any advanced date desired. Within the Alert Date parameter are three separate fields, month, day, and year. Use the “>” soft key to select the field within the date you want to edit. Use the “+” soft key to change the numeric value. Once you change the value it is automatically stored.

### **Date**

Within the Set Date parameter are four fields, date format (mdy / dmy), month, day, and year. Use the “>” soft key to select the field within the date you want to edit. Use

the “+” soft key to change the numeric value. Once you change the value it is automatically stored.

### Time

Within the Set Time parameter are three fields: hours, minutes, and Military or Standard time. Use the “>” soft key to select the field within the time parameter you want to edit. Use the “+” soft key to change the numeric value. Once you change the value it is automatically stored.

The Cal-Alert Warning screen appears as follows:

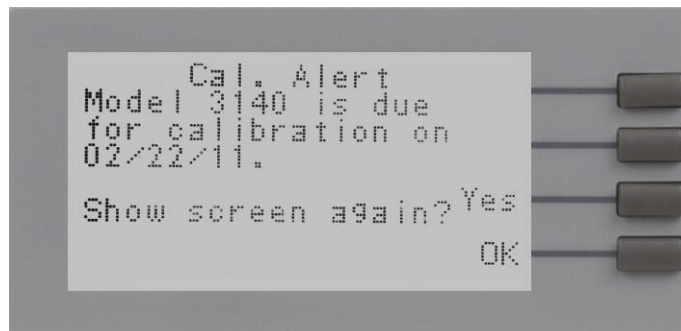

At the Cal-Alert Warning screen “Show screen again?” will be displayed along with the options “Yes” or “No.” The question must be answered by toggling between the words “Yes” and “No” using the corresponding soft key and then pressing the “OK” soft key. Selecting “No” will disable the Cal-Alert function. Selecting “Yes” will exit the Cal-Alert Warning screen and go to the standard introduction screen without disabling the Cal-Alert function.

If security is enabled this screen will not appear.

It is possible to quickly bypass the security of the Cal-Alert by powering up the instrument while pressing the soft key that is second from the top of the instrument. This will temporarily start the instrument in an unsecured state. The Cal-Alert Warning screen will be displayed and Cal-Alert may be disabled by selecting “No” and then pressing the “OK” soft key. This type of security override only affects the Cal-Alert screen. It is not necessary to restart the instrument to activate the security setting.

### 4.2.3. Default System Parameters

Setup System	PLC Remote	OFF
	Single Step	OFF
	Alarm	5
	Contrast	5
	Results	Last
	Lock	OFF
	Mem Lock	OFF
	Hipot Start	G→W
	Date Format	mdy (month, day, year)
	Cal Alert	ON
	Alert Date	Cal Date + 11 months

### 4.2.4. Memory, Step, and Default System Parameter Restore

#### **WARNING**

**Restoring the instrument's System parameters will overwrite all memories and steps with ACW default parameters!**

Press the two bottom soft keys and power the instrument at the same time, then press the soft key next to the word "Yes". All memories and steps will be loaded with the ACW default parameters and the system parameters will be set to the factory defaults.

The following System parameters will not be affected by the system initialization:

Setup System	Cal Alert	No change
	Cal Date	No change
	Cal Due	No change
	Alert	No change
	Date m/d/y	No change
	Time	No change

### 4.3. Test Setup

1. From the Perform Tests screen, press the "Menu" soft key. The Main Menu screen will now be displayed.
2. From the Main Menu screen, press the "Menu" soft key. Results, Test and System selections will now be displayed.
3. From this screen, press the "Test" soft key. The Test Parameter Review screen will now be displayed.
4. From this screen all relevant test parameters may be edited and saved. Refer to section **4.3.4. Default Test Parameters** for a complete list of test parameters.

### 4.3.1. Test Setup Soft Keys

#### **Directional soft keys** $\wedge, \vee, >$

The “ $\wedge, \vee, >$ ” soft keys are used to scroll the cursor to the different system parameters.

#### **+/- keys**

The “+” and “-” soft keys are used to increase or decrease numerical values or toggle settings ON and OFF.

#### **Enter key**

The “Enter” soft key is used to store a specific value for each test parameter.

#### **Edit key**

The “Edit” key is used to access a specific parameter and allow it to be changed.

#### **Esc key**

The “Esc” key is used to return to the Test Parameter Review screen during parameter editing without saving the new parameter value.

#### **Exit key**

The “Exit” soft key is used to return to the Test Parameter Review screen and the Perform Tests screen.

### 4.3.2. Test Parameters

Use the directional soft keys, “ $\vee, \wedge$ ” to navigate the test parameters during reviewing and editing. The directional soft keys will change depending on which parameter the cursor is pointing to.

**Current:** The Current that is applied between the Current and Return lead during a ground bond test.

**Max-Limit:** A maximum resistance threshold that when exceeded triggers a failure.

**Min-Limit:** A minimum resistance threshold that when not exceeded triggers a failure.

**Dwell Time:** A length of time that is allowed for the set point current to be applied.

**Frequency:** This parameter is selectable using a soft key between 50 and 60Hz.

**Connect:** This function when turned ON will connect or link the current step to the next step. The third step in a Memory will not have this function because it is the last step of the Memory location.

## Offset

The Offset function may be used to compensate for test lead and test fixture resistance during the test. Using the up and down arrow keys, scroll the cursor to the Offset parameter and press the “Edit” soft key. You may now manually or automatically set an Offset value.

To manually set the Offset, use the “+” and “-” soft keys to increase and decrease the resistance value. Press the “Enter” soft key to accept the new value or press the “Esc” soft key to escape from the edit.

To automatically set an Offset value, set the current and frequency to the values that will be used on the DUT and connect the test cables or test fixture with fixturing to the instrument. Next, short circuit the ends of the test cables and press the TEST button. The instrument will now read the lead resistance and update Offset parameter automatically. Press the “Enter” soft key to accept the new value or press the “Esc” soft key to escape from the edit.

### 4.3.3. Default Test Parameters

The following table is a listing of the Default Parameters in the HYAMP III. These parameters may be programmed to all of the memories and steps by pressing the two bottom soft keys and powering the instrument at the same time. The Default Parameters are as follows:

PARAMETER	VALUE
Current	25.00A
Max Lmt (current)	100mΩ
Min Lmt (current)	0mΩ
Dwell	1.0s
Frequency	60Hz
Offset	0mΩ
Connect	OFF

### 4.3.4. Setting Up a Test

From the Test Parameters Review screen scroll the cursor using the “^” and “v” soft keys to the Current parameter. Press the “Edit” soft key. Increase or decrease the Current parameter using the up and down arrow keys. Press the “Enter” soft key to accept the parameters or press the “Esc” soft key return to exit without saving.

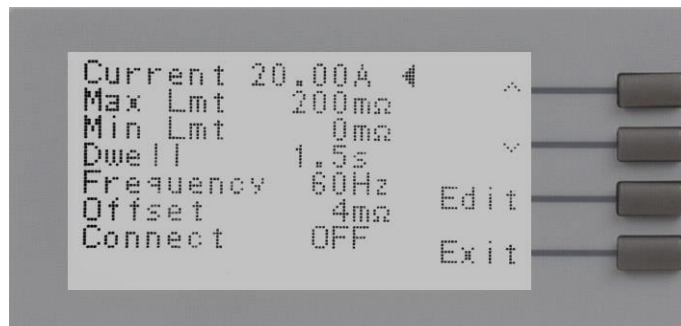

From the Parameter Review screens the following parameters may be selected for editing: Current, Max Lmt, Min Lmt, Dwell, Frequency, Offset, and Connect.

## 5. OPERATING INSTRUCTIONS

### 5.1. Instrument Connections

#### 5.1.1. Test Leads

The test leads provided are designed specifically for use with this instrument. The red High Current lead will mate with the red Current jack. The black Return lead will mate with the black Return jack.

The test lead ratings are as follows:

DESCRIPTION	PART NUMBER	RATING
High Current lead	05002D-24	31 A, 750V
Return lead	05002D-37	31 A, 750V

#### Connecting the Test Leads

Connect the High Current lead (05002D-24, red markers) to the Current connector on the HYAMP III, then connect the other end of the lead to the earth ground contact (usually the ground conductor connection point for the line cord inlet).

Connect the Return lead (05002D-37) to the Return connector on the HYAMP III, then connect the other end of the lead to chassis ground.

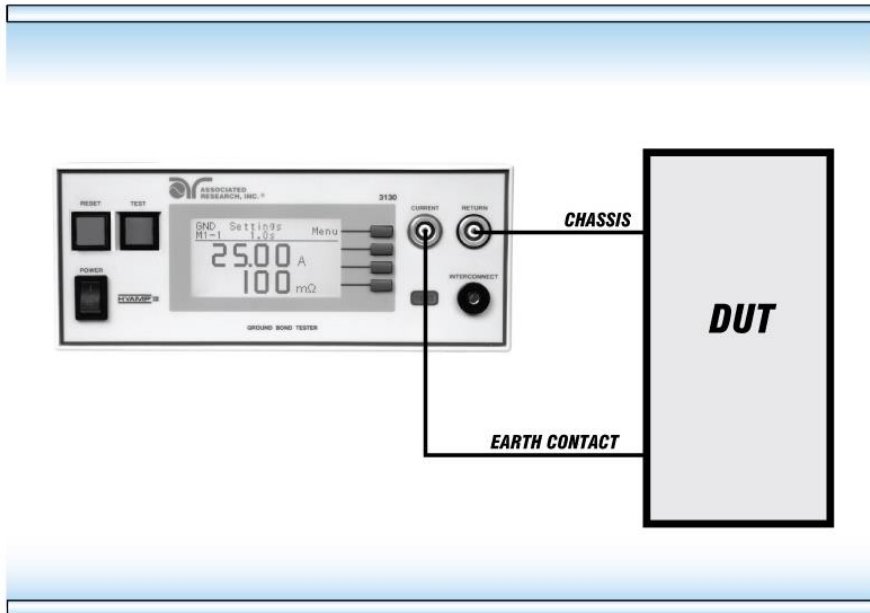

#### 5.1.2. Adapter Box Connections (Optional)

The adapter box provides an easy way to connect a line cord-terminated DUT to the HYAMP III. The following diagram shows how to connect the adapter box to the HYAMP III and to the DUT.

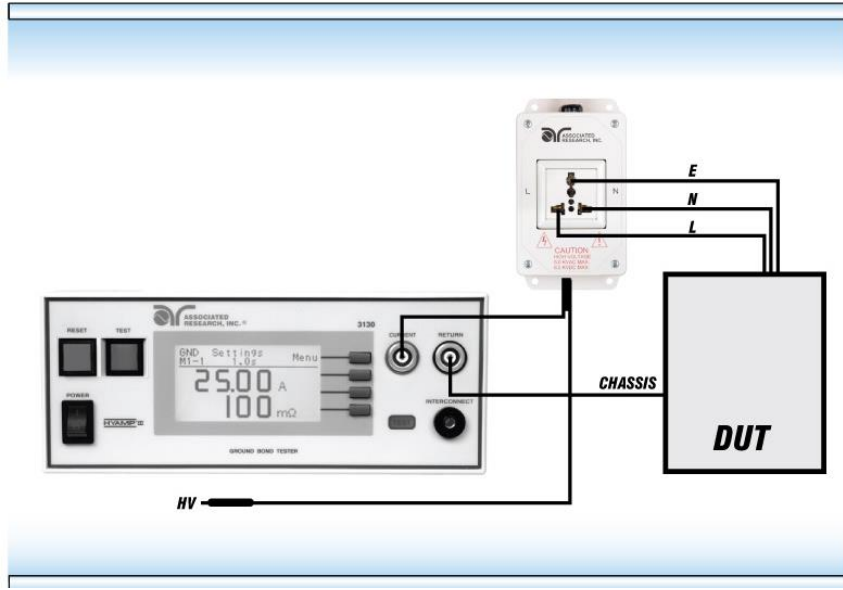

### 5.1.3. Interlock Connector

HYAMP III is equipped with a Remote Interlock feature. Remote Interlock utilizes a set of closed contacts to enable the instrument's output. If the Remote Interlock contacts are open the output of the instrument will be disabled. To disable the Remote Interlock feature connect the Interlock Key into the Signal Input port located on the back of the tester.



## 5.2. Performing a Test

1. From the Main Menu, select the memory and step you wish to perform then press the "Exit" soft key to return to the Perform Tests screen.
2. Attach the appropriate load or DUT to the instrument. Refer to section 5.1. **Instrument Connections** for instrument connections.
3. Press the TEST button.
4. The instrument will now perform the test or sequence of connected tests. If a test is started from any step other than 01, it will continue to start from that selected test step when you press the RESET or TEST buttons.

## 5.3. Test Metering

The HYAMP III Perform Test screen will display Current, Time, and Resistance during a test.

## 5.4. Results Screens

The HYAMP III may be configured to display one of three different types of Results screens (see section 4.2. **Setup System** for more information). To access the results screen use one of the following methods:

### Method 1, Hot key

Pressing the bottom soft key at the Perform Tests screen will display the Results screen.

### Method 2, Menu Selection

1. From the Perform Tests screen, press the “Menu” soft key. The Main Menu will now be displayed.
2. From the Main Menu screen, press the “Menu” soft key. The Results, Test and System selections will now be displayed.
3. From this screen, press the “Result” soft key. The Results screen will now be displayed. The Results screen will appear as follows:

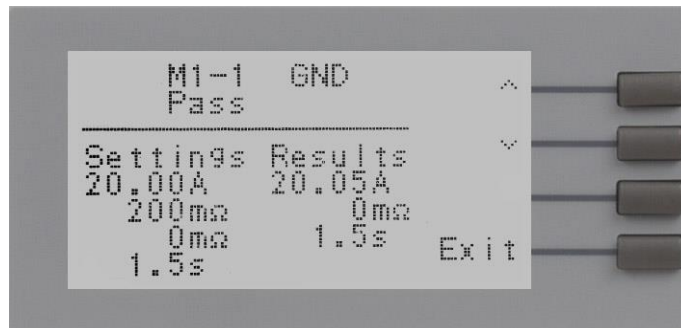

- **NOTE:** For multi-step tests, use the “^” and “v” soft keys to scroll through the results.

## 5.5. Error Messages

While performing tests a number of messages will be displayed to indicate the test state or test results. These messages are displayed in the status area of the screen located on the first line at the top of the LCD. These messages are also used on other screens where test results are displayed.



**Abort:** This message appears on the display, if the test in process is aborted with the RESET button or remote Reset control.

**Max-Fail:** This message appears on the display if the measured reading exceeds the Max Lmt current setting of the Ground Bond test, or Max Lmt resistance setting of the Insulation Resistance test.

**Min-Fail:** This message appears on the display if the measured reading drops below the Min Lmt current setting of the Ground Bond test, or Min Lmt resistance setting of the Insulation Resistance test.

**Short:** This message appears on the display, if the DUT current is well beyond the metering range of the test.

**Interlock Open:** This message appears on the display if the Remote Interlock feature is activated before or during a test. See section **6.2. Remote Signal Inputs and Memory Access** for more information.

**Out-Error:** This message appears on the display if the instrument has an internal problem and the TEST button is pressed. The RESET button is not active while this screen is displayed. To clear this screen and return to test mode press the “Exit” soft key. When the “Exit” soft key is pressed the instrument will continue with its normal failure indication process. The failure light and Alarm can then be cleared by pressing the RESET button.

- **NOTE:** If the instrument continues to power up in this condition it should be sent in for service or repair.

## 6. CONNECTION OF REMOTE I/O

Two 9 pin D-type connectors mounted on the rear panel provide REMOTE-INPUT-OUTPUT control and information. These connectors mate with a standard 9 pin D-type subminiature connector provided by the user. The output mates to a male (plug) connector while the input mates to a female (receptacle) connector. For best performance, a shielded cable should be used. To avoid ground loops the shield should not be grounded at both ends of the cable. Suggested AMP part numbers for interconnecting to the Remote I/O are shown below:

205204-4	PLUG SHELL WITH GROUND INDENTS
205203-3	RECEPTACLE SHELL
745254-7	CRIMP SNAP-IN PIN CONTACT (for plug)
745253-7	CRIMP SNAP-IN SOCKET CONTACT (for receptacle)
745171-1	SHIELDED CABLE CLAMP (for either plug or receptacle)
747784-3	JACKSCREW SET (2)

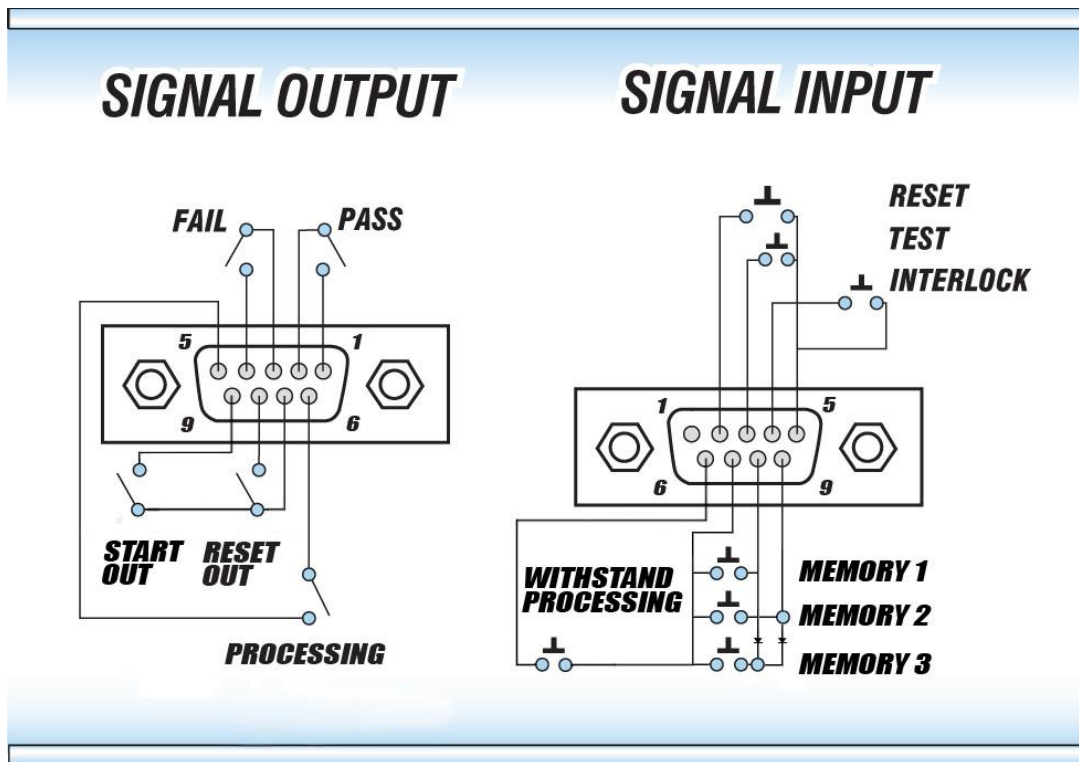

### 6.1. Remote Signal Outputs

The rear panel connector provides three output signals to remotely monitor PASS, FAIL, and PROCESSING conditions. The monitoring signals are provided by three normally open internal relays that toggle ON and OFF to indicate the condition of the tester. The RESET OUT pulse signal and the START OUT pulse signal are also provided by a normally open internal relay. The RESET OUT gives a signal whenever the RESET function is activated. This can be used to abort a Hipot test while the units are interfaced as a test system. The START OUT gives a momentary output pulse

that can be used to start a Hipot test. These are normally open free contacts and will not provide any voltage or current. The ratings of the contacts are 1 AAC / 125 VAC (0.5 ADC / 30 VDC). The signal outputs are provided on the 9 pin female D-type connector. Below is a list that indicates what conditions activate each pin. When a terminal becomes active the relay closes thereby allowing the external voltage to operate an external device.

Pins 1 and 2 provide the PASS signal.

Pins 3 and 4 provide the FAIL signal.

Pins 5 and 6 provide the PROCESSING signal.

Pins 7 and 8 provide the RESET OUT signal.

Pins 7 and 9 provide the START OUT pulse signal.

The following describes how the relays operate for each test condition.

**PROCESSING** – The relay contact closes the connection between pin (5) and pin (6) while the instrument is performing a test. The connection is opened at the end of the test.

**PASS** – The relay contact closes the connection between pin (1) and pin (2) after detecting that the item under test passed all tests. The connection is opened when the next test is initiated or the reset function is activated.

**FAIL** – The relay contact closes the connection between pin (3) and pin (4) after detecting that the item under test failed. The connection will open when the next test is initiated or the reset function activated.

**RESET OUT** – The relay contact closes the connection between pin (7) and pin (8) while the reset function is activated. This is only a continuous closure dependent on the length of time the reset button is held in an active state.

**START OUT** - The relay contact closes the connection between pin (7) and pin (9). The Hipot Start parameter directly controls the Start output relay. G→W will momentarily close the start output relay at the end of the HYAMP III test and G + W will momentarily close the start output relay at the start of the HYAMP III test.

The Hipot Start parameters main purpose is to control the sequential timing between HYAMP III and a connected Associated Research Hipot. The parameter controls if the Hipot will run after the HYAMP III has completed its test, G→W, or if the Hipot will run at the same time as the HYAMP III, G + W.

## **6.2. Remote Signal Inputs and Memory Access**

The HYAMP III remote connector enables remote operation of the TEST, RESET, and REMOTE INTERLOCK functions, and allows the operator to select Memory Location 1, 2, and 3.

When the PLC Remote mode is on, the HYAMP III will respond to simple switch or relay contacts closures. A normally open momentary switch can be wired across pins 3 and 5 to allow remote operation of the TEST function. A minimum pulse width or contact closure of 20mS is required to guarantee a test start. A normally open momentary switch can be wired across pins 2 and 5 to allow remote operation of the RESET function. A minimum pulse width or contact closure of 50mS is required to guarantee that a running test will abort. When the PLC remote function is (ON) the TEST switch on the front panel will be disabled to prevent a test from being activated through this switch. For safety, the front panel RESET switch remains active even when a remote reset switch is connected so that high voltage can be shut down from either location.

### DID YOU KNOW?

The Remote Signal Input connector may be used with various accessories, including light curtains, foot switches, and safety probes. Contact Associated Research, Inc. for more information.

The Remote File Select function gives the user the capability to quickly change parameters and initiate a test remotely. Three internal memory programs can be accessed by connecting terminals 7, 8, and 9 in different combinations. The memory select bits should be set simultaneously and remain set for a minimum of 1ms to guarantee that the correct memory will be selected.

### WARNING

ACTIVATING MEMORY PROGRAM FUNCTIONS THROUGH THE REMOTE CONNECTOR, SELECTS THE PROGRAM AND STARTS THE TEST WHICH IS PREPROGRAMMED INTO THAT MEMORY

### CAUTION

DO NOT CONNECT VOLTAGE OR CURRENT TO THE SIGNAL INPUTS, THIS COULD RESULT IN DAMAGE TO THE CONTROL CIRCUITRY.

Memory Location 1 – Momentarily connecting terminal 7 to 8 signals the instrument to immediately begin the test program that is stored in Memory Location 1.

Memory Location 2 – Momentarily connecting terminal 7 to 9 signals the instrument to immediately begin the test program that is stored in Memory Location 2.

Memory Location 3 – Momentarily connecting terminal 7 to terminals 8 and 9 signals the instrument to immediately begin the test program that is stored in Memory Location 3.

### Remote Interlock

HYAMP III is equipped with a Remote Interlock feature. Remote Interlock utilizes a set of closed contacts to enable the instrument's output. If the Remote Interlock contacts are open the output of the instrument will be disabled. Remote Interlock

could also be referred to as a remote system lockout, utilizing “fail when open” logic. If the Remote Interlock contacts are open and the TEST button is pushed, a pop-up message will be displayed on the screen for two seconds. The message will appear as follows:



If the Remote Interlock contacts are opened during a test, the pop-up message will be displayed and the test will abort. The hardware has been configured to provide the interlock connections on pins 4 and 5 of the Remote Interface, Signal Input port. The instrument can still be used without the external interlock device as long as the Interlock Disable Key (38075 provided with unit) is plugged into the Remote Interface, Signal Input port. If there is nothing connected to the Remote Interface, Signal Input port to provide a connection to the Remote Interlock, the instrument will not perform tests.



### **Withstand Processing**

When a HYAMP III is integrated with a Hypot III as a test system, the processing signal from the Hipot tester will be sent across pin (6) and pin (7) of the HYAMP III Remote Signal Input. This signal will activate the front panel “Withstand Processing” indicator that notifies the operator that high voltage is enabled.

If the Hipot start is set to G→W (sequential) then the “Withstand Processing” indicator will appear as the following pop-up message:

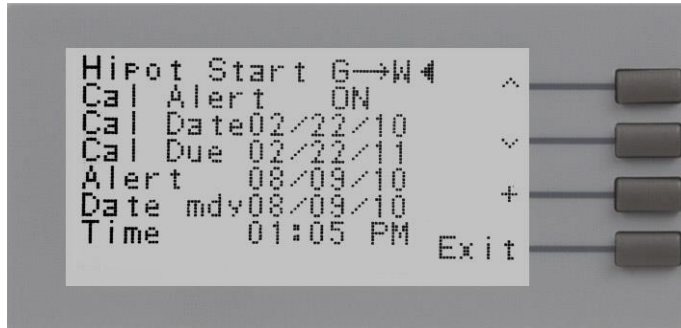

If the Hipot start signal is set to G+W then a small “W-T” indicator will appear in the upper right of the display.

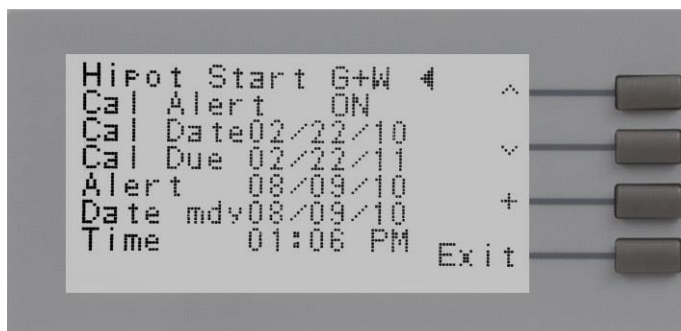

### PLC Remote Pop-up message

If you attempt to start a test from the front panel TEST button and the PLC remote function is turned “ON”, a pop-up message will be displayed. The pop-up message will appear as follows:



### 6.3. System 3100, HYAMP III Integrated with HYPOT III

The following illustration should be used to configure the HYAMP III for integrated operation with Hypot III:

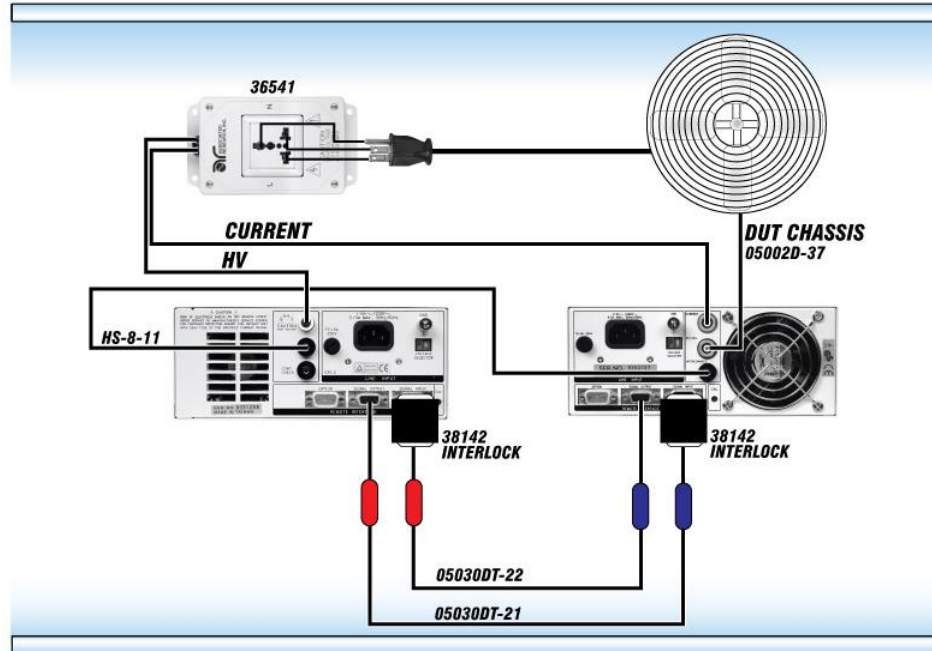

If you order the HYAMP III interconnect kit you will receive the following items.

INTERCONNECT KIT		
PART NUMBER	DESCRIPTION	QTY.
HS-8-11	Cable Assembly Return	1
5030DT-21	Cable Assembly R/P Interface COM	1
5030DT-22	Cable Assembly R/P Interface SEQ	1
38142	Interlock Connector	2
36541	Adapter Box HV, HC Domestic	1

When connecting HYAMP III to Hypot III the 38075 Interlock connectors may no longer be used. The 38142 Interlock connectors provided with the kit will replace these parts.

When Hypot III is connected to HYAMP III, the Hypot III should have PLC Remote turned "ON." In this configuration, you will only be able to start and reset the HYAMP III from the HYAMP III. It is possible to reset or abort the Hypot from both instruments.

### **Hipot Start parameter**

The Hipot Start parameter, found in the System Menu screen, controls whether the Hipot test will run sequentially after the Ground Bond test or simultaneously with the Ground Bond test. Please refer to section **4.1 Setup System** for instructions on how to set this parameter.

The Hipot Start parameter is only used when connecting the HYAMP III with an Associated Research Hypot III. The parameter determines if the Hypot will run after the HYAMP III has completed its test,  $G \rightarrow W$ . If the Hypot will run at the same time as the HYAMP III,  $G + W$ .

The Hipot Start parameter directly controls the Start output relay. Setting the Hipot start parameter to  $G \rightarrow W$  will momentarily close the start output relay at the end of the Ground Bond test. Setting the Hipot start parameter to  $G + W$  will momentarily close the start output relay at the start of the Ground Bond test.

## 7. OPTIONS

### Introduction

This section contains a list and descriptions of available factory installed options at the time of this printing. The list of options contains an option code number that can be referenced on the data plate on the rear panel of the unit.

### Option Label

On the rear panel of the instrument, you will find a label that contains the option code.

For example, your options code would appear as follows:

Fitted with option 04 ..... OPT: 04  
 Fitted with option 01and04..... OPT: 0104

### HYAMP III Options

#### Option List

CODE	DESCRIPTION
02	Continuous Output with PASS Buzzer
04	PLC Ready Output
05	External RS-232 Converter

#### Description

##### 02 Continuous Output with PASS Buzzer

The Continuous Output with PASS Buzzer option allows the user to perform multiple Ground Bond tests without the need to repeatedly energize and de-energize the output. All of the standard specifications for output ratings are the same as in the standard instrument. The operation of the failure judgment and the FAIL indication are the fundamental differences in the operation of the instrument.

To make the best use of the Continuous Output feature, the Dwell timer should be set to 0.0. If the Dwell timer is set to any value other than 0.0 s, the test results will be captured when the timer has completed until the test is restarted.

To start the Ground Bond test, the TEST button on the front panel can be pressed with the test leads connected or disconnected from the DUT. Once the test leads are connected to the DUT and the measured resistance is less than the Max Lmt setting and greater than the Min Lmt setting, the instrument will indicate a PASS condition. A PASS condition is represented by an audible alarm and the illumination of the green PASS light on the front panel.

When continuity is broken, the instrument measures a resistance value greater than the Max-Limit setting, or lower than the Min Lmt setting, the red FAIL indicator will illuminate and the alarm will turn OFF. The FAIL condition will remain until the

resistance drops below the Max Lmt setting or above the Min Lmt setting, or until the RESET button is pressed to de-energize the output.

This operation emulates basic audible Continuity testers found on many multi-meters, and is useful for doing multi-point Ground Bond tests on the DUT.

#### **04 PLC Ready Output**

The PLC Ready Output Option creates a signal that acts as an instrument power-on indicator. The signal is available through the Remote Signal Output connector which is located on the back of the instrument. This option closes the relay contact between pin (1) and pin (2) on the output connector once the instrument is powered on. The PLC Ready Output signal replaces the PASS signal that is present on the standard instrument.

It should be noted that the term “Ready” in “PLC Ready Output” only implies that the instrument is powered on. To perform a test, it should be verified that an Interlock device is used or the Interlock disable connector that was provided with the instrument is installed, and that there are no failure indicators active on the instrument. For more information on the Remote I/O and Remote Interlock refer to section **6. Connection of Remote I/O**.

#### **05 External RS-232 Converter**

The External RS-232 Converter option will allow for remote bus communication with the HYAMP III. The following image should be used to mount the RS-232 converter module to the case of the HYAMP III:



If you order the HYAMP III with External RS-232 Converter option you will receive the following items:

RS-232 External Module Part # 39050 includes:		
Part Number	Description	Qty.
39057	Cable 16 inch 9 Pin Male to 9 Pin Female Connector	1
38606	Cable Assembly RS-232 2 meter	1
37845	Screw M3 X 8mm FHMS Phillips	3

All instructions use the rear panel view as a reference point. The rear panel is shown above in the second illustration. The RS-232 external module is mounted to the left side of the HYAMP III. The following instructions detail the mounting of the panel.

Mount the RS-232 external module to the back left side of the HYAMP case using the three M3 X 8mm FHMS Phillips screws. The three screws currently in place there will need to be removed in order to mount the module. The SIGNAL INPUT port on the RS-232 external module should be facing the front of the HYAMP III and the SIGNAL OUT port should be facing the rear of the HYAMP III.

Connect the 16 inch 9 pin male to 9 pin female cable from the SIGNAL INPUT port on the RS-232 external module to the OPTION port on the rear of the HYAMP III. This connection will allow the HYAMP III to pass information to the RS-232 external module. Finally, connect the 2 meter RS-232 cable from the SIGNAL OUT port on the RS-232 external module to the appropriate PC. The unit is now set for remote bus communication.

### RS-232 Interface

The RS-232 cabling for the connection from the SIGNAL OUT on the RS-232 external module to the PC should be configured as follows for a 9-pin serial port interface:

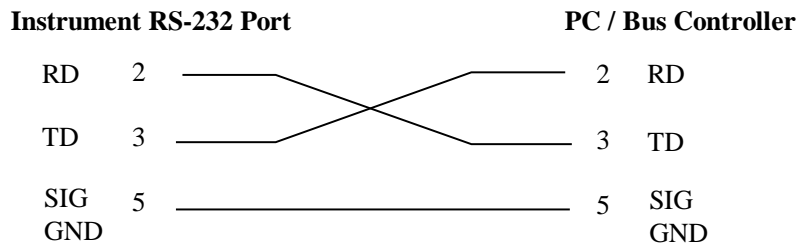

The COM port should have the following configuration:

- 19200 baud
- 8 data bits
- 1 stop bit
- No parity

This interface does not support XON/XOFF protocol or any hardware handshaking. The controller should be configured to ignore the handshaking lines DTR (pin 4), DSR (pin 6) CTS (pin 8) and RTS (pin 7). If the port cannot be configured through software to ignore these lines the handshake lines should be jumpered together in two different sets. Pins 4 and 6 should be jumpered together and pins 7 and 8 should be jumpered together at the controller end of the cable.

### **Sending Data**

Once a command is sent to the instrument over the RS-232 bus the instrument will send one of two responses. If the transfer was recognized and completed the instrument will return with 06 hex or 6 decimal, the Acknowledge (ACK) ASCII control code. If there is an error with the command string that is sent, the instrument will respond with 15 hex or 21 decimal, the Not Acknowledge (NAK) ASCII control code. The ACK or NAK response allows for software handshaking to monitor and control data flow.

### **Receiving Data**

When requesting data from the instrument it will automatically send the data back to the controller input buffer. The controller input buffer will accumulate data being sent from the instrument, including the ACK and NAK response strings, until it has been read by the controller.

### **RS-232 Interface Command List**

The RS-232 bus will automatically send any response back to the controller's input buffer. Note that the commands are case sensitive and must be typed in capital letters. Each command string should be terminated by the ASCII control code, New Line <NL>, or OAh.

The following conventions are used to describe the commands syntax for the HYAMP III. Braces ( { } ) enclose each parameter for a command string. Triangle brackets ( < > ) indicate that you must substitute a value for the enclosed parameter. The Pipe ( | ) is used to separate different parameter options for a command. The command and the parameter data must be separated with a space. All commands that end with a question mark ( ? ) are query commands.

### **Test Execution Commands**

The following commands are used to control actual output voltage and current from the instrument. Please observe all safety precautions.

<b>Command</b>	<b>Description</b>
TEST	Execute a Test
RESET	Abort a Test in Process or Reset Failures
AOFF	Auto Set Offset

### **TEST**

Starts the test sequence at the selected step loaded into memory (RAM).

## RESET

Stop or abort a test. Also used to reset a latched failure condition.

## AOFF

Set the offset for the ground bond test. The cables and any test fixture should be connected before executing the command. This command will perform an actual test and all safety precautions should be observed when using this command.

## File Editing Commands

The following commands are used to create or modify Test Setup Files.

Command	Description	Value
MSS <memory number step number>	Memory Step Select	memory number = 1-10 step number 1-3
SALL<memory+step,p1,p2,p3...>	Add all Parameters of a Test	

### MSS<memory number step number>

Load a file by memory and step number. The first digit is the memory number and the second digit is the step number. Example: MSS 11 = memory 1 step 1

### SALL <memory+step, p1, p2, p3... >

This command edits all parameters in a memory and step. Parameters will be edited at the step location that has been selected. Example: SALL<11,10.00,100,0...>

The parameter <memory+step> indicated the memory and step number. The parameters <p1,p2> etc. indicate the individual settings for each test. All parameters must be included with the command and should appear in the same order that is shown in the table below. Also, like the individual parameter editing commands, the unit should not be included with the value. Only the numeric value should be included in the command string. The list of parameters can also be found in the default parameters section of the manual, or refer to the Test Parameter Editing commands section for the proper values. The parameter values should use complete text and not use the coded values that are associated with the individual parameter setting commands such as "ON" and "OFF" for toggle field.

	GND
1	Memory + Step
2	Current
3	Max Limit
4	Min Limit
5	Dwell
6	Frequency
7	Offset
8	Connect (ON/OFF)

### Test Parameter Editing Commands

These commands are used to modify the test parameter within each step. These commands require a parameter value to be included with the command. The writing of the parameter requires that the unit not be included with the value, only the numeric value should be included with the command.

Command	Name	Value
CONN {1 0}	Connect ON/OFF	1=On, 0=Off
CURR <value>	Edit Current	1.00-30.00A
DDT <value>	Dwell Time	0, 0.5-999.9sec
MAXL <value>	Edit Max Limit	0-510mΩ
MINL <value>	Edit Min Limit	0-510mΩ
FREQ {50 60}	Edit Frequency	50 or 60Hz
COFF <value>	Offset	0-100mΩ

### System Parameter Editing Commands and Companion Queries

These commands are used to modify the system parameters for the instrument. These commands require a parameter value to be included with the command.

Command	Name	Value
PLC {1 0}	PLC Remote ON/OFF	1=On, 0=Off
SSTP {1 0}	Single Step ON/OFF	1=On, 0=Off
ALAR <value>	Alarm Level	0-9, 0=Off, 9=High
CNTR <value>	Contrast Level	0-9, 9=High
RLT {L A P}	Result Setting	L=Last, A=All, P=P/F
HS {1 0}	Hipot Start	0=G→W, 1=G+W

### Query Commands

These query commands will retrieve data from the instrument. These commands include functions for retrieving test data, test results and remote hardware.

Command	Name	Value
TD?	List Testing Data	Data from test in Process
RD <step number>?	Result Data Query	1-3
SALL?	List Step Parameters	Response: SALL memory+step,p1,p2,p3...
RR?	Read Reset Query	1=Open, 0=Closed
RI?	Read Interlock Query	1=Open, 0=Closed

### TD?

Read the active data being displayed on the LCD display while the test is in process. It will also read the last data taken when the test sequence has completed. Each

parameter is separated by commas and includes step number, test status, and metering. The syntax for this command response is {memory - step, status, meter 1, meter 2, meter 3}.

For example: M1-1,Pass,25.00A,100mΩ,1.0s

### **RD <step number>?**

Read the results for an individual step. The step number is the actual step number that has been saved within the file, not the order of which the steps were executed. For example if the test was executed starting from step 2 and ending with step 3 then the first step test results will be found in location 2 not in location 1. Each parameter is separated by commas and includes step number, test status, and metering. The syntax for this command response is {memory - step, status, meter 1, meter 2, meter 3}. For example: M1-1,Pass,25.00A,100mΩ,1.0s

### **SALL?**

Lists all the step parameters for the step currently selected. Each parameter is separated by commas and includes memory with step number and parameter values. The syntax for this command response is SALL memory+step, current, max limit, min limit, dwell, offset, connect.

### **RR?**

Read the remote Reset input signal. When the remote reset has be activated by closing the contacts the query will return a value of 0 to indicate the instrument is being Reset.

### **RI?**

Read the remote Interlock input signal. When the remote Interlock has be activated by opening the contacts the query will return a value of 1 to indicate the instrument is in the Interlock state and will not be able to generate output voltage or current.

## 8. INSTRUMENT VERIFICATION

Verification is the process by which an instrument's failure detectors are proven to be functioning properly by performing basic tests in open and short circuit conditions. Verifying the failure detection circuitry of the electrical safety tester is required by safety agencies such as CSA, UL, and TÜV.

- **NOTE:** Verification should be performed at the beginning of each day or each shift, before testing has begun.

### 8.1. Verification Initialization

Power up the tester. The initialization screen will appear with a message at the bottom indicating press TEST for verification. You now have the option to press the TEST button and activate the Verification Menu. The option to activate verification expires approximately 3 seconds after power-up. The Initialization screen will appear as follows:



### 8.2. Verification Menu

From the Initialization screen (first start up screen), press the TEST button. The Verification Menu will now be displayed.



- **NOTE:** During the verification process, all Remote control output signals except the FAIL output are disabled.

## Ground Bond Verification

From the Verification screen, press the TEST button to begin the verification process.

At the end of the Verification process, a message will appear indicating the outcome of the process. If the instrument passes the Verification (test failure, indicating the fail detectors are working properly) the RESET button will illuminate, the alarm will sound and the following message will appear:

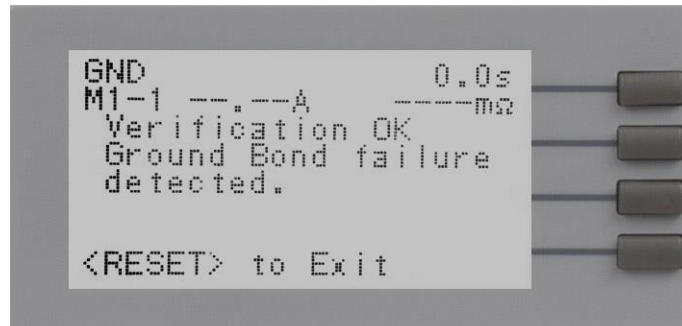

If the instrument fails the Verification (test pass, indicating the fail detectors are not working properly) the following message will appear:

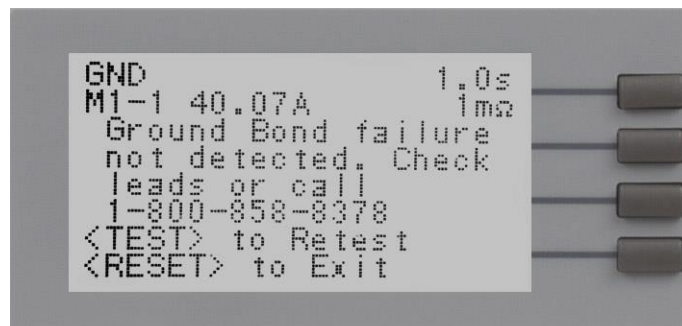

## 9. CALIBRATION PROCEDURE

### DID YOU KNOW?

This instrument has been fully calibrated at the factory in accordance to our published specifications and with standards traceable to the National Institute of Standards & Technology (NIST).

You will find in this manual a copy of the "Certificate of Calibration". It is recommended that you have this instrument recertified at least once per year. Associated Research, Inc. recommends you use "Calibration Standards" that are NIST traceable or traceable to agencies recognized by NIST to keep this instrument within published specifications. Unless necessary, do not recalibrate the instrument within the first 12 months.

End user metrology standards or practices may vary. These metrology standards determine the measurement uncertainty ratio of the calibration standards being used. Calibration adjustments can only be made in the Calibration mode and calibration checks or verifications can only be made while operating in Test mode.

- **NOTE:** Verification should be performed before and after calibration. Calibration effects will only be noticeable after exiting calibration mode.

### 9.1. Warranty Requirements

Associated Research, Inc. offers a standard one-year manufacturer's warranty. This warranty can be extended an additional four years provided that the instrument is returned each year to Associated Research, Inc. for its annual recertification. In order to be eligible for the extended warranty instruments must be returned to Associated Research, Inc. for certification service at least once every twelve months.

A return material authorization number (RMA) must be obtained from Associated Research, Inc. before returning this instrument for calibration. To obtain an RMA number or for information regarding our warranty, please contact our customer support representatives at 1-800-858-TEST (8378) or setup an RMA online at <http://www.asresearch.com/support/RMA-request.aspx>.

#### Required Calibration Equipment

- 30 Amp AC Ammeter.
- 10 VAC Voltmeter.

### 9.2. Calibration Initialization

Press and hold the Calibration key on the rear panel with a pen, pencil or small screwdriver while powering ON the HYAMP III. The HYAMP III enters the calibration mode after the power on sequence is complete. The Calibration screen will appear as follows:

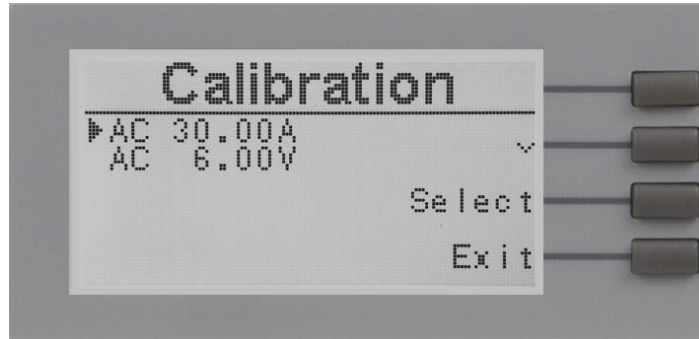

### 9.2.1. Calibration of Parameters

From the Calibration screen, use the “v” soft key to scroll the cursor to the parameter you wish to calibrate. Once the cursor is pointing to the parameter you wish to calibrate, press the “Select” soft key. A calibration prompt screen will now appear.

The following is a list of the calibration parameters and an example of the prompt screen with the details that will be displayed for each parameter (screen shown at left). Once you press the TEST button, the Calibration Data Entry screen will appear. Adjust the numeric value of the parameter using the “+” and “-” soft keys and press the “Enter” soft key to accept the new parameter or press RESET to escape the edit.

### 9.2.2. Calibration of Ground Bond AC Current

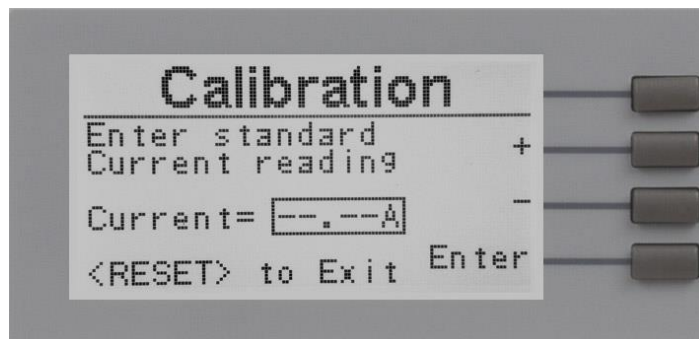
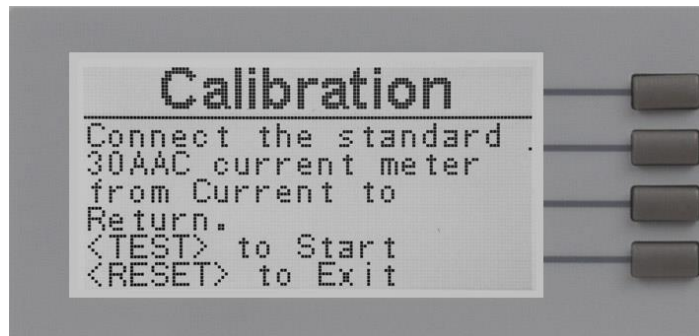

### 9.2.3. Calibration of Ground Bond AC Voltage

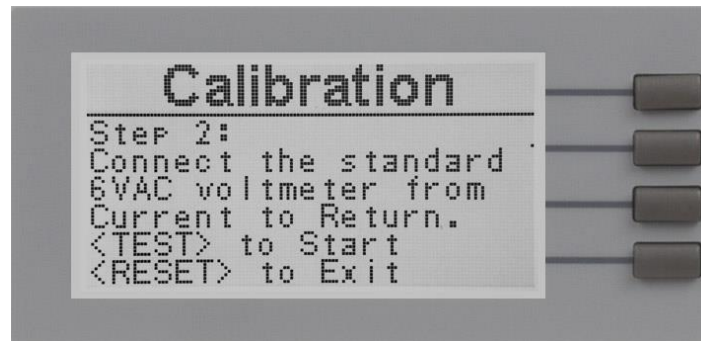
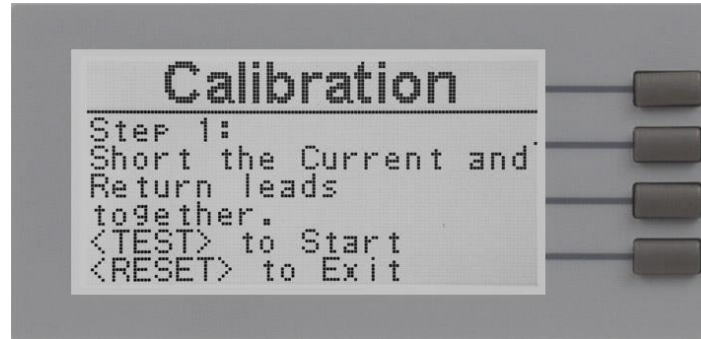

## 10. REPLACEMENT PARTS LIST

Rev. E 4/22/14 ECO 5696-1

### 3130

Part Number	Qty.	Reference Designator	Description
<b>Supplied Accessories</b>			
37780	1	-	Fuse, 6.3 Amp slow-blow, 250VAC
36541	1	-	Adapter Box, Optional
38075	1	-	Interlock Connector
05002D-24	1	-	Cable ASSY High Current Output
05002D-37	1	-	Cable ASSY High Current Return
<b>Panel Components</b>			
35999	2	-	Black Banana Jacks
37239	4	-	High Current Connectors
37497	1	-	Reset Switch, Red
37555	1	-	Power Switch 2P 10A/250V
37571	1	-	Earth Connector
39391	1	Test/Pass	Replacement Bulb
39392	1	Reset/Fail	Replacement Bulb
37673	1	-	Test Switch, Green
38101	1	-	Feet Kit w/o Rubber Inserts
38102	4	-	Rubber Insert for Feet
38320	1	-	128 x 64 Graphic Display
<b>ICs and PCB Assemblies</b>			
38846	1	IC19	Microcontroller SM89516A PLCC
38367	1	CON 3670	Main Control Board
38325	1	AMP 3130	Power Amplifier Board
38331	1	KEY 3670	Keypad Board
38268	1	PWR 3670	Input Voltage Select PCB
39050	1	RS232	Kit RS232 External module
<b>Internal Components</b>			
38326	1	T1	Input Transformer

## Index

Adapter Box	17, 32, 41, 55
Arc	3, 31
Benefits	9
Breakdown	3, 4
Calibration	11, 26, 52
Calibration Alert	
Alert Date	26
Cal Alert	22, 26, 27, 28
Cal Date	22, 26, 28
Cal Due	22, 26, 28
Date	22, 26, 28
Time	22, 27, 28, 31
Calibration Procedure	50, 52
Connected Steps	20, 21, 23, 24, 33, 52
Contrast	16, 22, 24, 28
Controls	12, 15, 17, 21, 22, 26, 37, 42
DC Withstand	35
Default Parameters	28, 30
Dielectric Withstand Test	28
Discharge	7
DUT	7, 30, 32, 33, 35
Dwell	15, 29, 30, 31
Edit Parameters	26, 27, 29, 30, 53
ESD	6, 7
Exit Key	23, 29
Features	9
Frequency	3, 4, 15, 29, 30, 31
FRONT PANEL CONTROLS	9, 17
Glossary	3
Insulation Resistance	35
Interlock	9, 10, 16, 19, 33, 35, 38, 39, 41, 45, 55
LCD	9, 17, 24, 34
Leakage	4, 13
Limits	35
Lock	22, 25
Lockout	39
Max Lmt	30, 35
Medical Restrictions	7
Memory	16, 19, 20, 21, 25, 28, 29, 33, 35, 37, 38
Menu	16, 20, 21, 22, 25, 28, 33, 34, 42, 50, 51
Min Lmt	30, 35
Offset	9
Operator	6, 7, 8, 9, 12, 14, 18, 37, 39
Options	27, 43
Parameters	
System Parameters	22, 23, 29

Test Parameters	9, 16, 20, 22, 29
PLC	22, 23, 28, 38
Power	4, 6, 12
Power Factor	4
Programming	20
Rear Panel Controls	12, 18
Receptacle	18, 36
Regulation	15
Remote	9, 16, 19, 22, 23, 28, 33, 35, 36, 37, 38, 39, 40, 41, 50
Remote Interlock	33, 35, 38, 39
Resistance	4, 7, 12, 29, 30, 33, 35
Return	13
Reviewing Test Results	25
Safety	3, 5, 7, 12
Safety Symbols	3
SECURITY	9, 16, 25, 27
Sequence	21, 23, 24, 33, 52
Service	1, 3, 5, 11, 35, 52
Service Interval	5
Setup	9, 12, 22, 23, 28, 29, 34, 42
Short	30, 35, 50
Single Step	22, 23, 28
Smart GFI	22
Specifications	15
System Parameters	22, 23, 28, 29
Test Parameters	20, 22, 28, 29, 30
Test Station	6, 7
Trip Point	31
UL	50
Unpacking	10
Verification	16, 50, 51
Warranty	1, 2, 52
Warranty Policies	1