

The logo for Sefram, featuring the word "Sefram" in a white, sans-serif font centered within a red rectangular background. Below the red rectangle is a thin, horizontal grey line.

Sefram

RECORDERS

8460-DAS1600 – DAS800-DAS801

INSTRUCTION MANUAL

Edition January 2017

M1600001A/8

Thank you for buying a SEFRAM recorder and for your trust in our company. The main goal of our various teams (engineering office, production, commercial, after sales...) is to meet your requests as much as possible while designing and updating high-tech products.

You will find with a recorder a CD-ROM including:

The instruction manual of the 8460/DAS1600 and DAS800/DAS801 recorders
The "SeframViewer" software for printing and treating record files under Windows®

We ask you to read carefully this instruction manual for an optimal use of your recorder.

For any additional information, our teams are at your disposal:

+33(0)4 77 59 01 01

Sales service e-mail: sales@sefram.fr

After-sales service e-mail: sav@sefram.fr

Technical support e-mail: support@sefram.fr

Fax: +33 (0)4 77 57 23 23

Web: www.sefram.fr



Copyright Sefram, 2016. All rights reserved
Any copy of this document, total or partial, requires the authorization by Sefram.

GUARANTEE

Your instrument is guaranteed for two years for labor and parts against any manufacturing defect and/or functioning hazard. This guarantee extends from the delivery date and ends 730 calendar days later.

In case of guarantee contract, this will cancel or replace these guarantee conditions here above.

The guarantee conditions by SEFRAM are available on the website www.sefram.com. The general guarantee conditions should prevail on the following conditions that they sum up.

This guarantee does not cover the result of any abnormal use, handling mistake or mistake in the storage conditions outside the defined range.

In case of application of the guarantee, the user shall return, at its own expenses, the relevant appliance to our factory:

SEFRAM Instruments & Systèmes
Service Après-Vente
32, Rue Edouard MARTEL
BP 55
42009 SAINT-ETIENNE CEDEX 2

And add a description of the observed breakdown to the appliance.

The standard supplies provided with the appliance (cables, outlets...), the consumables (batteries ...) and the optional supplies (suitcases...) are guaranteed for 3 months against any manufacturing defect.

Such items as a LCD screen or a touchpad are guaranteed only for a normal use.

The guarantee does not cover wearing, accidental breaks or consecutive to a shock or any abnormal use.

The factory options integrated to the appliance are guaranteed for the same duration as the appliance itself.

In case of replacement or repair of the product, the remaining guarantee duration shall be:

- The remaining duration of the guarantee if the appliance is still under guarantee
- If the guarantee duration is less than 90 days, the replaced part is guaranteed for 90 days

Any replacement part becomes the property of the user and the exchanged parts become the property of SEFRAM.

In case of intervention by an insurance company, the product becomes the property of the insurance company upon its exclusive request. Else, it shall remain property of the user.

The guarantee covers exclusively the materials manufactured and provided by SEFRAM.

Any intervention by the user or any third party without prior authorization by the company voids the guarantee.

The user shall be responsible for the return of its appliance to our site. Hence, it shall provide for a conditioning that shall correctly protect the appliance while shipping. It shall subscribe, at its own expenses, any insurance required for the transport.

The SEFRAM company reserves the right to refuse any product wrongly conditioned and not to take in charge any break consecutive to the transport.

Particular case of the battery: There is a Li-ion battery as a standard equipment of this appliance. It shall not be transported outside the appliance. In no case shall the user replace it. Its replacement in the factory is necessary to check the charge system and the protective securities.

What to do in case of malfunction?

In case of malfunction or for any advice for use, please contact the technical support by SEFRAM Instruments & Systèmes:

A technician shall answer you and give you any information required to solve your problem.

What to do in case of failure?

In case of failure of your appliance, please contact the technical support:

Some advice!

Some technical help!

SEFRAM Instruments & Systèmes commits itself to help you on the phone about the use of your appliance.

Please call or Technical Support:

Or e-mail:

support@sefram.fr

We thank you for your trust.

METROLOGY

The meteorological conditions of your measurement instrument are defined in the specifications of this notice. Climate and environmental conditions restrict the specifications of your recorder. SEFRAM checks the characteristics of each appliance one by one on an automatic bench during its manufacture. The adjustment and control are guaranteed under conditions of the ISO9001 certification by facilities in connection with the COFRAC (or equivalent in the context of ILAC reciprocity).

The specified characteristics are considered stable for a period of 12 months from the first use under normal conditions of use.

We recommend a check after 12 months and max. 24 months of use, then every 12 months after 24 months.

For any check of the characteristics, the following average climate conditions shall be maintained ($23^{\circ}\text{C} \pm 3^{\circ}\text{C} - 50(\pm 20)\% \text{RH}$). The recorder should have been working for 0,5 hour before check.

We recommend that you have this control made by our after-sales service (Service Après-Vente) for the best service and preservation of the measuring quality of your instrument.

When a recorder returns to SEFRAM, maximum service is provided with internal updating according to the required adjustments and software updates. In case of shift in the characteristics, your instrument shall be adjusted to recover its original characteristics.

CONTENT

1. IMPORTANT INFORMATION.....	1.1
1.1. PARTICULAR PRECAUTION MEASURES	1.1
1.2. SECURITY INSTRUCTIONS.....	1.2
1.3. SYMBOLS AND DEFINITIONS.....	1.2
1.4. CONFORMITY AND LIMITATIONS OF THE APPLIANCE.....	1.3
2. PRESENTATION.....	2.1
2.1. GENERAL.....	2.1
2.2. DESCRIPTION.....	2.2
2.2.1. Description of the screen.....	2.5
2.2.2. Bar graph patterns.....	2.6
2.3. SCREEN KEYS	2.7
2.4. UPDATING THE INTERNAL SOFTWARE.....	2.10
2.5. USE OF THE 8460 STAND.....	2.10
3. SET-UP AND PRECAUTIONS OF USE	3.1
3.1. 8460 INSTALLATION OF RECORD PAPER	3.1
3.2. POWER	3.2
3.2.1. Turning on the instrument.....	3.3
3.3. CONFIGURATION AT START-UP.....	3.4
3.4. CONNECTION TO THE MEASUREMENT NETWORKS	3.5
3.4.1. Connection:.....	3.5
3.4.2. Voltage measurement.....	3.5
3.4.3. Temperature measurement with a thermocouple	3.6
3.4.4. Gauge strain measurement.....	3.6
3.4.5. Temperature measurement with PT100 and PT1000.....	3.8
3.4.6. Intensity measurement.....	3.9
3.4.7. Earth.....	3.9
3.5. ROUTINE MAINTENANCE.....	3.10
3.6. CALIBRATION OF THE OFFSETS	3.11
3.7. DEFAULT SETUP.....	3.11
3.8. USER MODE.....	3.12
3.9. KEYBOARD LOCKING	3.12
4. USE.....	4.1
4.1. “MODE DIRECT” KEY.....	4.1
4.2. « MODE MEMORY » KEY	4.1
4.3. « MODE FILE » KEY	4.2

4.4.	« GO/NO-GO » KEY.....	4.2
4.5.	« USER MANUAL » KEY.....	4.2
4.6.	« POWER ANALYSIS » KEY	4.2
4.7.	« SETUP ANALYZER » KEY	4.2
4.8.	« SETUP » KEY	4.3
4.9.	CHANNEL KEY	4.6
	4.9.1. Analogical channels	4.6
	4.9.2. Functions between channels.....	4.10
4.10.	« LOGIC CHANNELS » KEY	4.17
4.11.	« VALIDITY » KEY	4.18
4.12.	« F (T) » KEY	4.19
4.13.	« XY » KEY	4.23
4.14.	« NUMERIC » KEY	4.24
4.15.	« TRIGGER » KEY	4.25
4.16.	« REPLAY » KEY	4.26
4.17.	« START/STOP » KEY	4.27
4.18.	« SCREEN COPY » KEY	4.28
4.19.	« HOME » KEY	4.28
5.	TRIGGERS.....	5.1
5.1.	TRIGGER WITH COMBINATION ANALOG CHANNEL	5.2
	5.1.1. Analog channel (only one threshold)	5.2
	5.1.2. Combination Analog channel (several thresholds)	5.3
	5.1.3. Threshold triggering	5.4
	5.1.4. Slope trigger.....	5.5
5.2.	TRIGGER WITH LOGICAL CHANNELS.....	5.6
6.	MATHEMATICAL CALCULATIONS.....	6.1
6.1.	DEFINITIONS	6.1
6.2.	TYPES DE CALCULATIONS	6.2
7.	DIRECT MODE	7.1
7.1.	OUTLINE SETUP.....	7.1
7.2.	OUTLINE TRIGGERING	7.2
7.3.	REARMAMENT OF THE OUTLINE.....	7.5
7.4.	INFORMATION WRITINGS.....	7.5
8.	MEMORY MODE.....	8.1
8.1.	SET-UP AND TRIGGERING OF THE DATA ACQUISITION	8.1
8.2.	SAMPLING PERIOD	8.3
8.3.	INTERNAL MEMORY _ BLOCKS	8.3
8.4.	TRIGGER POSITION	8.4
8.5.	DOUBLE TRIGGER MODE	8.4
8.6.	RECORDING	8.5
8.7.	MEMORY OUTPUT	8.7
9.	GO-NOGO MODE.....	9.1

9.1.	SET-UP AND TRIGGERING OF THE DATA ACQUISITION	9.1
9.2.	CREATION OF THE CALIBER.....	9.2
9.3.	USE OF THE CALIBER.....	9.3
10.	FILE MODE	10.5
10.1.	SET-UP AND TRIGGERING OF THE DATA ACQUISITION	10.5
10.2.	ANNOTATION.....	10.7
10.3.	COMPARE FILES AND REFERENCE.....	10.8
10.3.1.	<i>Reference file</i>	10.8
10.3.2.	<i>Texte File</i>	10.8
10.3.3.	<i>Compare with wall paper</i>	10.10
10.4.	LIMITATION	10.11
11.	POWER ANALYSER.....	11.1
11.1.	GENERAL.....	11.1
11.2.	INSTALLATION: "SET-UP ANALYZER" MENU	11.2
11.3.	DISPLAY OF THE SIGNAL:	11.4
11.4.	TRIGGER MENU	11.5
11.4.1.	<i>Parameter acquisition file</i>	11.5
11.4.2.	<i>Acquisition file of the harmonics</i>	11.6
11.4.3.	<i>Recordable parameters</i>	11.6
11.5.	RECORD.....	11.8
11.6.	MEASUREMENT METHOD	11.9
12.	FILE MANAGEMENT.....	12.1
12.1.	GENERAL.....	12.1
12.2.	MANAGING THE SET-UP FILES	12.2
12.2.1.	<i>Saving set-up files</i>	12.3
12.2.2.	<i>Loading set-up files</i>	12.3
12.3.	MANAGING THE DATA ACQUISITION FILES	12.4
12.3.1.	<i>Saving acquisition files</i>	12.4
12.3.2.	<i>Loading acquisition files</i>	12.5
12.4.	RECYCLE BIN	12.5
13.	PRINTING	13.1
13.1.	SET-UP AND START OF THE PLOT.....	13.2
13.2.	SELECTION OF THE PRINTER.....	13.3
13.3.	PRINTER FOR USB CONNECTION.....	13.4
14.	INPUT / OUTPUT.....	14.1
14.1.	ADDITIONAL INPUT / OUTPUT CONNECTOR	14.1
14.2.	LOGICAL INPUTS	14.2
14.2.1.	<i>Use</i>	14.2
14.3.	ALARM OUTPUTS	14.3
14.3.1.	<i>Use</i>	14.3
14.4.	POWER SUPPLY OUTPUT	14.3

14.5.	EXTENSION BOX FOR INPUT/OUTPUT INTERFACE.....	14.4
14.5.1.	Use.....	14.6
15.	INTERFACE	15.1
15.1.	ETHERNET INTERFACE	15.1
15.1.1.	General.....	15.1
15.2.	NTP PROTOCOL.....	15.3
15.3.	PTP PROTOCOL.....	15.4
15.4.	IRIG SYNCHRONIZATION (OPTIONAL).....	15.4
15.5.	WIFI CONNECTION	15.6
15.6.	CREATE A WIFI HOTSPOT.....	15.9
15.7.	OPERATING SOFTWARE	15.10
15.7.1.	File transfer under FTP.....	15.10
15.7.2.	Display under SeframViewer.....	15.11
15.7.3.	Control with VNC Viewer:	15.12
16.	TECHNICAL SPECIFICATIONS.....	16.1
16.1.	ISOLATED 1000V INPUTS	16.1
16.1.1.	General characteristics	16.1
16.1.2.	Voltage record.....	16.2
16.1.3.	RMS record.....	16.2
16.1.4.	Derivative and integral record.....	16.2
16.1.5.	Frequency record	16.3
16.1.6.	Counting record	16.3
16.1.7.	Sampling.....	16.3
16.1.8.	Bandwidth.....	16.3
16.1.9.	Numeric filters.....	16.4
16.2.	ISOLATED 500V INPUTS	16.5
16.2.1.	General characteristics	16.5
16.2.2.	Voltage recording.....	16.6
16.2.3.	RMS recording.....	16.6
16.2.4.	Derivative and integral record	16.6
16.2.5.	Temperature record.....	16.7
16.2.6.	Frequency record	16.7
16.2.7.	Counting record.....	16.7
16.2.8.	PWM record	16.8
16.2.9.	Sampling.....	16.8
16.2.10.	Bandwidth.....	16.8
16.3.	MULTIPLEXED INPUTS	16.10
16.3.1.	General Characteristics.....	16.10
16.3.2.	Voltage record	16.10
16.3.3.	RMS record.....	16.11
16.3.4.	Counting record.....	16.11
16.3.5.	Derivative and integral record	16.11
16.3.6.	Temperature record.....	16.11

16.3.7.	<i>Sampling</i>	16.12
16.3.8.	<i>Bandwidth</i>	16.12
16.4.	STRAIN GAUGE INPUTS	16.13
16.4.1.	<i>General characteristics</i>	16.13
16.4.2.	<i>Voltage record</i>	16.13
16.4.3.	<i>RMS record</i>	16.14
16.4.4.	<i>Derivative and integral record</i>	16.14
16.4.5.	<i>Strain gauge record</i>	16.14
16.4.6.	<i>Temperature record</i>	16.15
16.4.7.	<i>Sampling</i>	16.15
16.4.8.	<i>Bandwidth</i>	16.15
16.5.	ADDITIONAL INPUTS / OUTPUTS	16.16
16.5.1.	<i>Logic channels</i>	16.16
16.5.2.	<i>Alarm Outputs</i>	16.16
16.5.3.	<i>External power supply</i>	16.16
16.6.	CIRCUIT ANALYSIS	16.17
16.6.1.	<i>Ranges and Accuracies Voltage and Intensity</i>	16.17
16.6.2.	<i>Frequency</i>	16.18
16.6.3.	<i>Power factor</i>	16.18
16.6.4.	<i>Peak factor</i>	16.18
16.6.5.	<i>Harmonics rate calculated in power analysis</i>	16.18
16.6.6.	<i>Multiple circuits</i>	16.18
16.7.	DISPLAY	16.19
16.8.	MEMORY ACQUISITION	16.19
16.9.	ACQUISITION ON FILES	16.19
16.10.	COMMUNICATION INTERFACE	16.19
16.11.	THERMAL PAPER	16.20
16.12.	MISCELLANEOUS	16.20
16.12.1.	<i>USB connector</i>	16.20
16.12.2.	<i>Screen connector</i>	16.20
16.13.	ENVIRONMENTAL CONDITIONS FOR THE 8460 RECORDER	16.21
16.14.	ENVIRONMENTAL CONDITIONS DAS 1600/DAS800/DAS801	16.22
16.4.1.	<i>Weather conditions</i>	16.22
16.4.2.	<i>Mains</i>	16.22
16.14.3.	<i>Dimensions and weight</i>	16.22
16.15.	ELECTROMAGNETIC COMPATIBILITY, SECURITY	16.23
16.15.1.	<i>Electromagnetic compatibility DAS1600/DAS800</i>	16.23
16.15.2.	<i>Electromagnetic compatibility 8460</i>	16.24
16.15.3.	<i>Security, Isolation Class, Installation Category</i>	16.25
16.16.	MISCELLANEOUS	16.26
16.16.1.	<i>Internal saving battery</i>	16.26
16.17.	ACCESSORIES	16.27
16.17.1.	<i>Accessories provided with the appliance</i>	16.27
16.17.2.	<i>Accessories and options</i>	16.28

16.17.3.	<i>Consumable items</i>	16.28
16.18.	BATTERY OPTION	16.28
16.19.	IRIG BOARD OPTION	16.29
17.	APPENDIX	17.1
17.1.	INFORMATION ABOUT THE CALIBER OF THE INPUTS	17.1
17.1.1.	<i>Inputs of isolated voltage type</i>	17.1
17.1.2.	<i>Inputs of multiplexed card voltage type</i>	17.2
17.1.3.	<i>Input of thermocouple type</i>	17.2
17.2.	ACCURACY OF THE THERMOCOUPLE MEASUREMENTS	17.3
17.3.	MEASUREMENT ACCURACY FOR PT100.....	17.5
17.4.	ACCURACY OF INSTANT MEASUREMENT ACCORDING TO THE FILTERS	17.7
17.5.	NOTE ON THE MEASUREMENT UNITS FOR A GAUGE STRAIN.....	17.8
17.5.1.	<i>Conversion rules</i>	17.8
17.5.2.	<i>Calculation details</i>	17.8
17.5.3.	<i>Display of the characteristics of the bridge in mV/V</i>	17.10
17.5.4.	<i>Example of unit change</i>	17.10
17.6.	ACCURACY CLASS – CLASS INDEX	17.11

1. IMPORTANT INFORMATION

Please read carefully the following instructions before using your recorder.

1.1. Particular precaution measures

Do not use the product for any other use than specified.

Use normalized cables to connect the appliance to the measurement points.

Use the provided power cable to avoid any degradation of the appliance and guarantee its characteristics in measurement.

To prevent any risk of electric shock, do not plug or unplug the measurement cables when connected to the power supply.

Do not use in a wet environment.

Do not use in an explosive environment.

In case of defect or for the maintenance, only a qualified personal should be allowed to work on the appliance. In this case, it is necessary to use Sefram spare parts.

Do not open the appliance when live.

1.2. Security instructions

For a correct use of the appliance, the users must abide by the security and use requirements as described in this manual.

Specific alert signals appear all along this manual.

In case of need, there are alert symbols on the appliance:



This is a CLASS 1 appliance: in case of any electrical or external defect during use, the current is evacuated to the earth to protect the user.



You **MUST NOT** disconnect the protective of the appliance.

1.3. Symbols and definitions

Symbols appearing in this document:



Caution: potential danger for the user.



Attention: potential danger for the appliance and/or the connected equipment.



Remark: important information.

Symbols on the appliance:



Danger (High Voltage): immediate corporal danger.



Attention: refer to the instruction manual. Potential damages to the appliances connected to the instrument or to the instrument itself.



Earth: accessible parts connected the earth of the appliance.

1.4. Conformity and limitations of the appliance

The 8460/ DAS1600/ DAS800/DAS801 recorders are conform to the norm CEI 61010-1 (2001-02).

See chapter "**Technical specifications**".



Attention: Never apply a voltage higher to the maximum admissible voltage between the channels and between a channel and the earth.

2. PRESENTATION

2.1. GENERAL

The 8460/DAS1600/ DAS800 and DAS801 are programmable recorders that allow to measure and record voltages, intensities, temperatures etc.... as well as on 16 logic channels.

The DAS1600 can be configured with 6 boards maximum (72 channels max), universal isolated or isolated strain gauge, or non-isolated multiplexed. The DAS800 has not an integrated thermal printer and possesses just 1 board. The 8460 can be configured with 3 boards maximum.

You have 3 available types of inputs:

- isolated universal inputs through 6-channel module, up to 6 modules
- non-isolated differential inputs, multiplexed through 12-channel module, up to 6 modules
- isolated strain gauge through 6-channel modules
- 1000 V inputs through 6-channels modules

Several work modes are available:

- a Memory mode for acquisition on internal fast memory
- a File mode for acquisition on an internal hard drive or USB stick
- a Template mode for acquisition on a pre-recorded template
- a Circuit Analysis mode to make measurements on the circuit

Only the File mode is available for the DAS801.

The "operator-recorder" dialog is made easier thanks to very clear menus on a wide LCD screen. The measurement parameters can be easily configured: you can do it with the keyboard on the touch screen, with a stylus or with a mouse and an external keyboard. The recorders can be fully programmed through Ethernet link.

2.2. DESCRIPTION

The recorders have the same input-output connectors on the rear side.

- 1- a RJ45 connector for the ETHERNET 10/100/1000BaseT interface
- 2- a SUB-D 15-pin connector for monitor output
- 3- 4 USB-2 ports at the rear and 2 USB ports at the edge for the DAS800/DAS801/DAS1600
- 4- a SUB-D 25-in connector for the 16 logic inputs and the alarm outputs
- 5- access to the 3 A, B and C input modules (isolated or non-isolated according to the configuration of the appliance)
- 6- an earth pole
- 7- Power supply ON/OFF switch. In the case of a device with the battery option, this button doesn't switch ON or OFF the DAS but only switch on or off the battery charge.
- 8- a mains plug
- 9- (Battery option) Device ON/OFF.
- 10- (IRIG option) BNC plug to connect the external IRIG clock

Isolated universal input modules have 2 safety terminals for each input:

- 1 red terminal: “+” input
- 1 black terminal: “-” input

Non-isolated differential input modules have 5 screw terminals for each input:

- 2 terminals marked as “+” and “-” for the voltage input
- 2 terminals marked as “I+” and “I-” for the PT100 input
- 1 earth terminal connected to a ground

For other input/output poles, see chapter “**Inputs/Outputs**”.

DAS1600 – DAS800 –DAS801

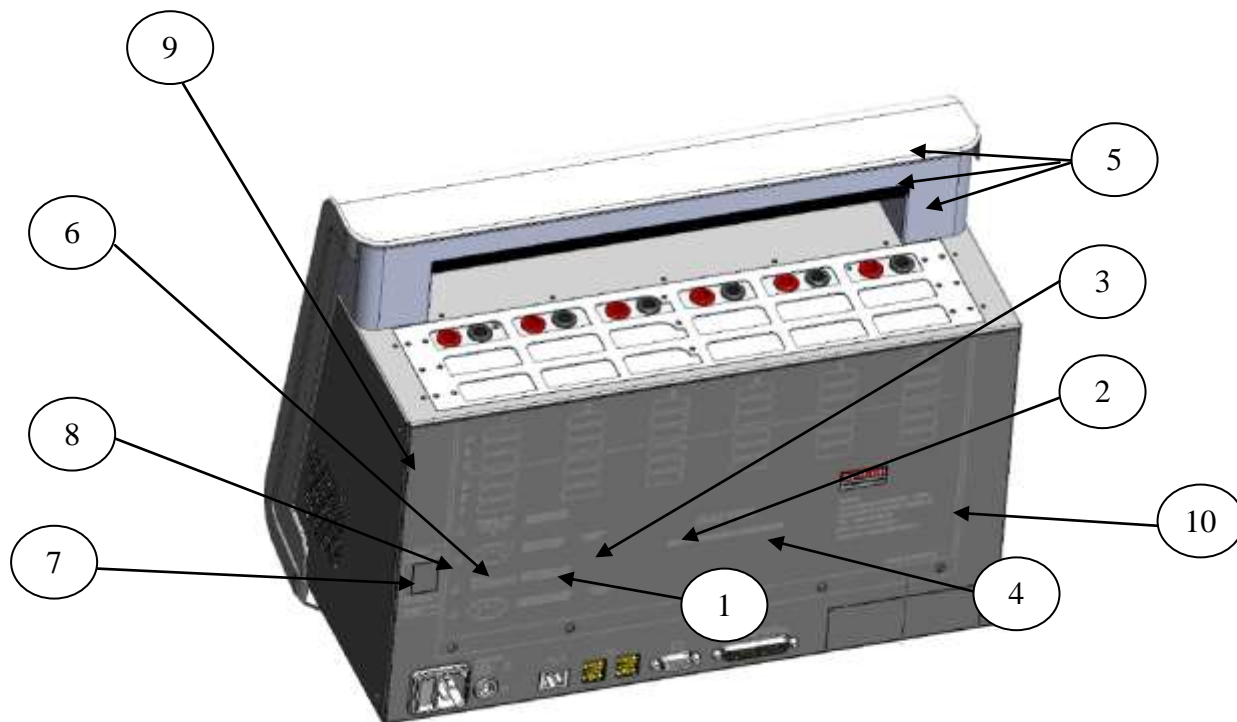

8460

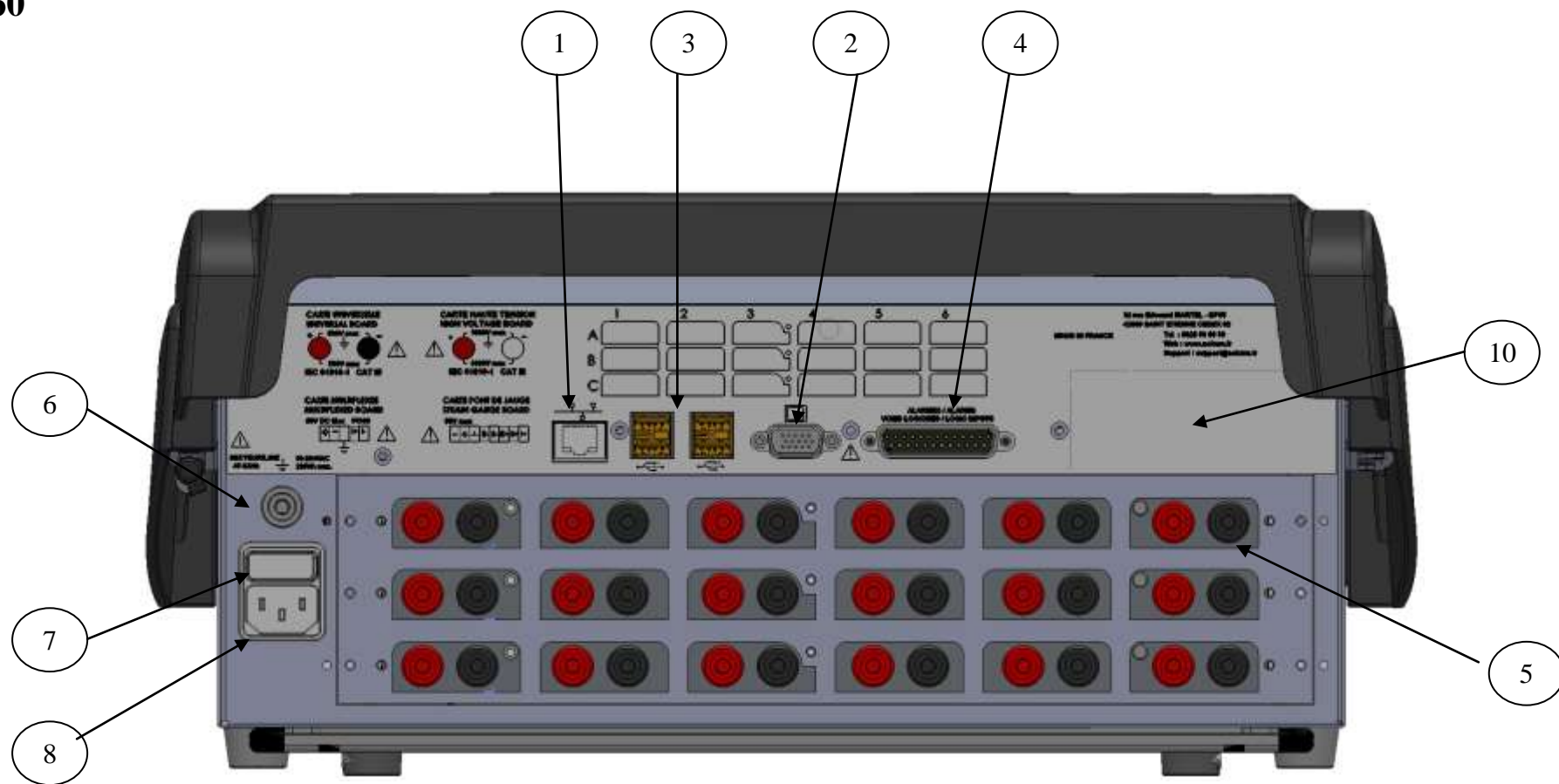

2.2.1. Description of the screen

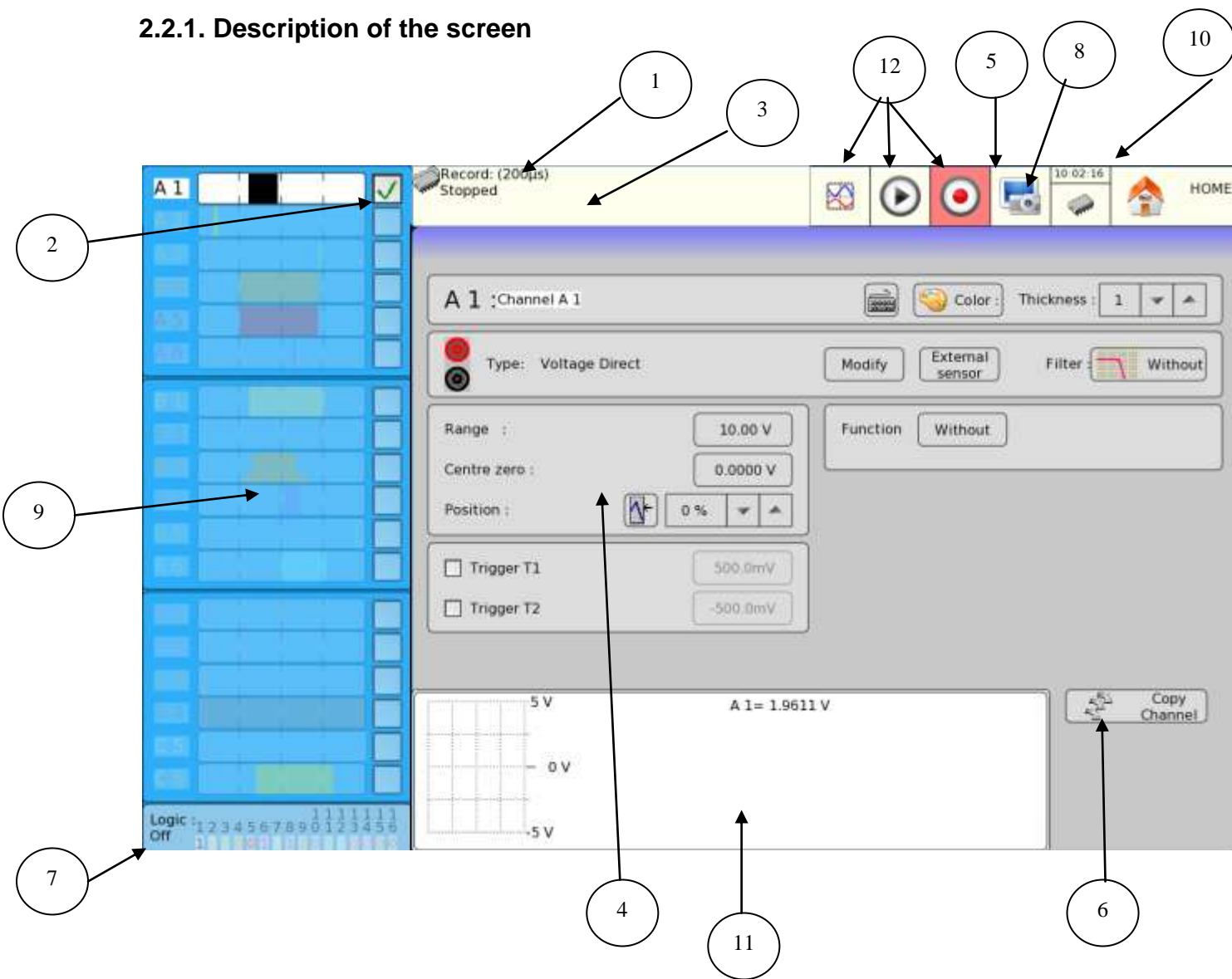

The different zones on the screen:

- 1- STATUS: acquisition mode, acquisition status or printing status
- 2- VALIDATION: selection of the channels to use
- 3- CHANNEL: name of the currently used channel
- 4- PARAMETERS: name of the modifiable parameters and their current values;
- 5- PRINTING SCREEN: for displaying the recorder on screen
- 6- COPY CHANNEL: copies the configurations of a channel to the selected channels
- 7- LOGIC INPUTS: real time status of the logic channels
- 8- MODE: current mode (here Memory mode)
- 9- ANALOGIC INPUTS: bargraph of the current values of the inputs
- 10- MAIN MENU: gives access to the main menu to change the mode, the function, access to the notice...
- 11- GRAPHICAL ZONE: visualization of the printings
- 12- SHORTCUTS

2.2.2. Bar graph patterns

The bar graph, located in the screen's left corner, has two different running mode depending on the number of board connected to the device.

→ **Less than 3 board connected** : All the channels are displayed

→ **More than three board connected** : A new menu appears at the bar graph top letting you choose between three different channels groups

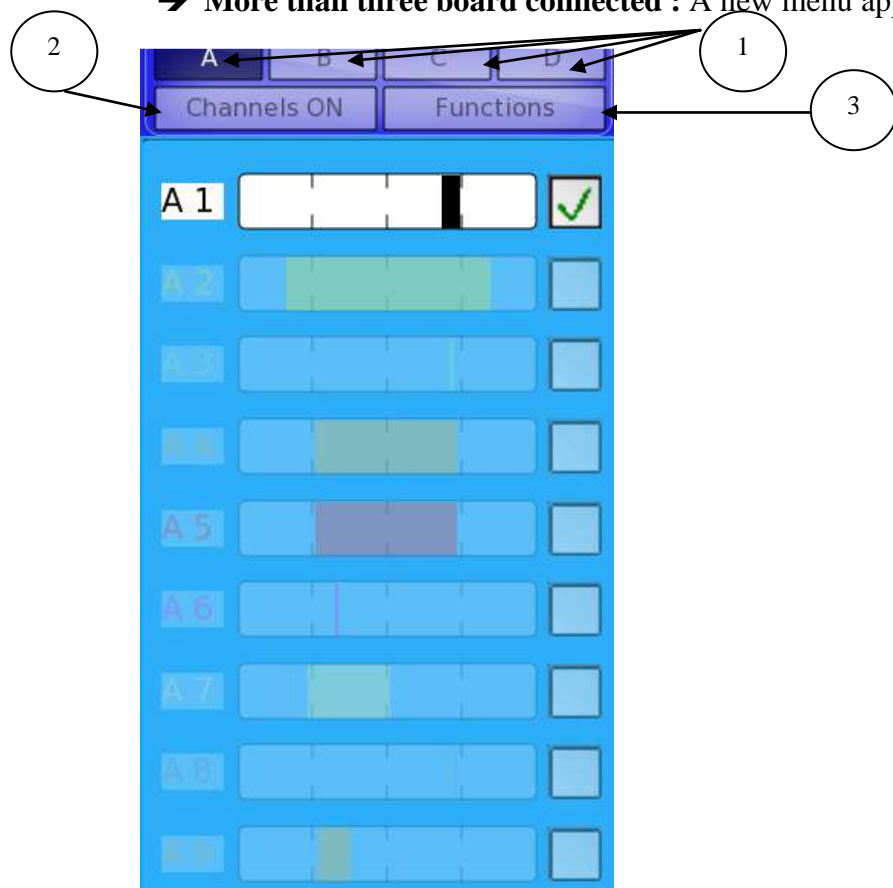

Visualization modes:

1-SORT BY BOARD: Choose the board from which you want to display channels

2-CHANNELS ON: Only selected channels will be displayed

3-FUNCTIONS : Only mathematical channels will be displayed

2.3. SCREEN KEYS



- « **USER MANUAL** » key: display of the instruction manual



- « **LOGIC CHANNELS** » key: configuration of the logic channels

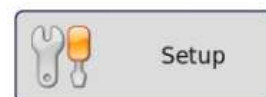

- « **CONFIG** » key: general configuration of the appliance (language, date and time, alarm outputs, software updates...)

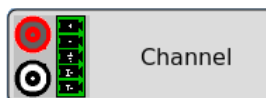

- « **CHANNEL** » key: access to the parameters of each channels, access to the functions between channels



- « **VALIDITY** » key: selection of the channels for each acquisition (on paper, screen, internal memory or file)



- « **SETUP ANALYZER** » key: configuration of the parameters for circuit analysis

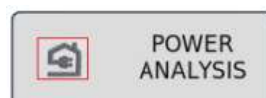

- « **POWER ANALYSIS** » key: launching measurements of power, harmonics... of the circuit

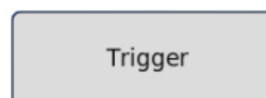

- « **TRIGGER** » key: launching parameters of the acquisitions (on paper, internal memory or file according to the current MODE)



- « **REPLAY** » key: display on screen of the acquisitions on internal memory or file, measurement cursors, zoom, calculations

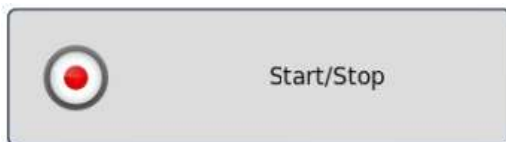

- « **Start/Stop** » key: launching of the data acquisition under the all MODES



- « **MODE : MEMORY** » key: configuration of the parameters of measurement record into internal memory



- « **MODE : FILE** » key: configuration of the parameters of measurement record on file



- « **MODE : GO/NOGO** » key: configuration of the parameters of measurement record into internal memory under a template

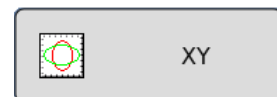

- « **XY** » key: real time display on screen of the validated channels in XY mode

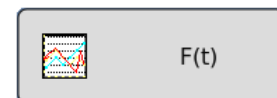

- « **F(t)** » key: real time display on screen of the validated channels



- **C** » key: real time display on screen of the digital values of the validated channels

Specific to 8460:



“**DIRECT MODE**” key: configuration of the parameters of the outline in real time on thermal paper

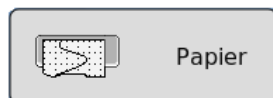

“**PAPER**”: parameters of the outline on thermal paper

2.4. UPDATING THE INTERNAL SOFTWARE

The internal software is regularly updated with its latest evolutions. These updates are available on our website.

To update the software, copy the file provided onto an USB stick. Plug it on one of the USB ports at the rear of the appliance.

Press the  key, then select the « **Modification Version/Option** » parameter line and validate « **Charge** ».

A window pops up; select « **modify** » on the line « **Modification Version** ».



The internal software copies automatically the required files to the new version.

Turn off and on when the update is finished.

2.5. USE OF THE 8460 STAND

The stand below the 8460 recorder allows using the instrument vertically with a slight slope backwards for a better visual comfort.



CAUTION: You must lock the stand.

To do this, when it is in place, press hard on the upper sides in order to block it on its means of retention.

To close it, pull both sides simultaneously.

3. SET-UP AND PRECAUTIONS OF USE

3.1. 8460 Installation of record paper

The thermal paper required to 8460 is delivered with a sharpened end to make its installation easier. In a case of used roller, it is recommended to give it again this shape.

NOTE: only one face of the paper is sensitive in a thermal way. Reversing during the installation will result in the absence of any writing.

Actions to perform:

- Tip the gate towards you
- Introduce the paper axle in the roller
- Put the paper axle set and the roller at the bottom of the tray. The “no of ref” inscription must be on the left.
- Introduce the paper tip in the crack noticed on the stainless steel tray.
- Get back the paper by the tip above the feed roller, below the small ruler that cuts the paper.
- Pull the paper of few centimeters to place it in a good way.
- Close the table

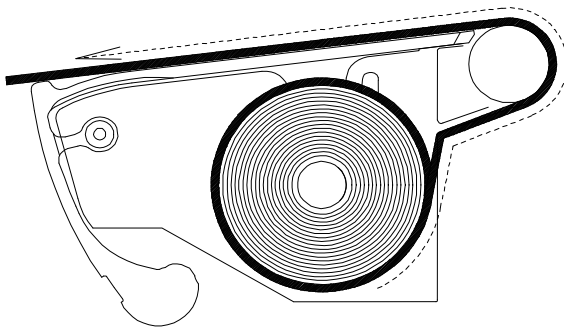

Installation of the paper roller



A bad unreeling of the paper may be harmful for the motor and the thermal print head. So install it very carefully.

The recorder must always have paper in it because the thermal print head is damaged by a prolonged direct contact with the roller.

Recordings Storage precautions

In order to preserve the quality of paper recordings, it is recommended to observe the precautions of use:

- Plastic pouches are forbidden
- Store away from the light and in a dry and fresh place

It is recommended to use cardboard pouches.

3.2. POWER

The recorders work on normalized mains (See chapter Technical specifications).

They are designed for indoor use.



MAINS CONNECTION

These instruments must be connected to the mains with the provided cord.



SECURITY

These instruments are **security class I** according to the classification CEI1010 (NF EN 61010) Security rules for electrical appliances for measurement, regulation and laboratory.

They must be powered ob a 1-phase circuit according to the **installation category II** (overvoltage category).



GROUNDING

These instruments must be connected to the earth with the provided cord.



It is **FORBIDDEN** to interrupt the grounding inside or outside the instrument: it would make the instrument **DANGEROUS**.



In case of more than three 500V board are plugged to the device, it is **obligatory** to connect the two protection grounds (the auxiliary protection earth and the power cord's earth)
The interruption of one of this ground, in the device or outside the device is **FORBIDDEN** and make it **DANGEROUS**..



The use of the battery requires **imperatively** to plug the device's protection earth or the power supply wire for safety reasons
For the devices plugged to 500V board the maximum number of board authorized is lowered to 3..

3.2.1. Turning on the instrument

You turn the recorders on at the rear of the appliance, by triggering the **ON/OFF** switch to "I".

Battery option: press the (9) key at the rear of the instrument to start and stop the recorder. This key allows you to start the appliance by supplying it directly with the battery if the mains switch (indication 7 on the figure) is on 0 or with a main power supply if the mains key is on 1.

The switch (1) must be on 1 to charge the battery when the instrument is switched on or switched off.

After starting up the internal software, the recorder displays a homepage specifying:

- the software version: Version x.y
- the number of channels: 6, 12, 18 or more

Then switches automatically to a visualization mode « **F(t)** » or « **XY** » (oscilloscope).

3.3. CONFIGURATION AT START-UP

At power up, the appliance starts with the configuration at the latest stop (voluntarily or after power shortage).



If the configuration has changed at the power-up, contact the after-sales service.









If the initial configuration is wrong, you can start with the default configuration:

You must then press several times the top right of the appliance at the start-up until the homepage shows up (at the place of the main Menu key under normal conditions).





3.4. CONNECTION TO THE MEASUREMENT NETWORKS

3.4.1. Connection:

Strain gauge input module:

	1	1: measurement input -
	2	2: measurement input +
	3	3: ground of the measurement drawer (connection of the cable shield)
	4	4: - pole of the powering of the strain gauge bridge (-1V or -2.5V)
	5	5: control of the powering - of the field (6-wire mode)
	6	6: + pole of the powering of the strain gauge bridge (+1V or +2.5V)
	7	7: control of the powering + of the field (6-wire mode)
	8	8: I+ pole

Non-isolated differential input module:

	1	1: measurement input +
	2	2: measurement input -
	3	3: ground of the measurement drawer (connection of the cable shield)
	4	4: I+ pole
	5	5: I- pole

3.4.2. Voltage measurement

Isolated input module 500V: The voltage measurement is made between the red and black poles of the inputs with wires equipped with male security banana plugs (according to CEI 1010).

Isolated input module 1000V: Voltage measurement is made between the red and white poles.

Non-isolated differential input module: The voltage measurement is made between the « + » and « - » poles of the inputs with wires on the screw terminal block.

Isolated strain gauge input module: The voltage measurement is made between the « + » and « - » poles of the inputs with wires on the screw terminal block.

3.4.3. Temperature measurement with a thermocouple

Isolated input module: The voltage produced by the thermocouple effect must be measured between the red and black poles of the concerned input. To guarantee a right measurement, connect directly both ends of the thermocouple cord on banana plugs. Plug these two banana plugs onto the input you want with respect for the polarity.



Do not use male banana plugs for welding: the soldered joint would alter the thermocouple effect.

Non-isolated differential input module and Isolated strain gauge input module: The voltage produced by the thermocouple effect must be measured between the « + » and « - » poles of the inputs with wires on the screw terminal.

To guarantee the right measurement, plug directly both ends of the thermocouple cord on to the input you want with respect for the polarity.

3.4.4. Gauge strain measurement

Wiring of a complete 4-wire bridge:

Programming the channel in « gauge » « complete bridge » type (see chapter Channel)

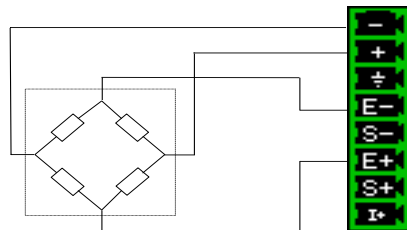

Wiring of a complete 6-wire bridge:

Programming the channel in « gauge » « complete bridge » type (see chapter Channel)

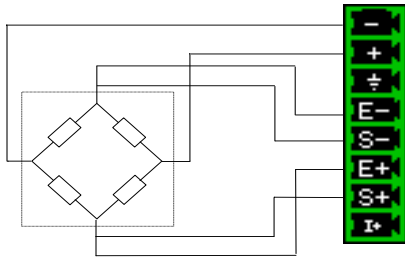

Wiring of a half bridge:

Programming the channel in « gauge » « half bridge » type (chapter Channel)

The other half bridge is internal to the appliance (2 resistances 10 k Ω 0.1% 10 ppm)

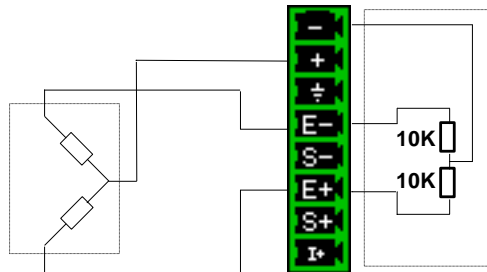

3.4.5. Temperature measurement with PT100 and PT1000

The PT100 probe must be connected on the « I+ » and « I- » poles (1 mA current generator output) (I+ and ground for the input strain gauge module). The PT100 probe is only possible on the isolated strain gauge input module (0.1 mA output).

The voltage produced by the PT100 must be measured between the « + » and « - » poles with one of the following assemblies: 2 wires, 3 wires or 4 wires. The 4-wire mounting makes the measurement value independent from the resistance of the line.

2-wire mounting:

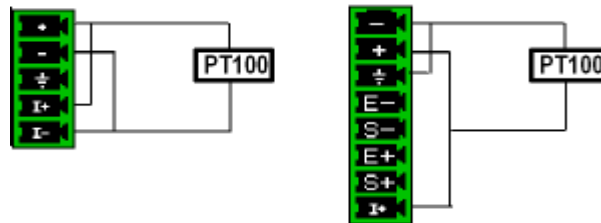

3-wire mounting:

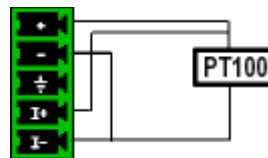

4-wire mounting:

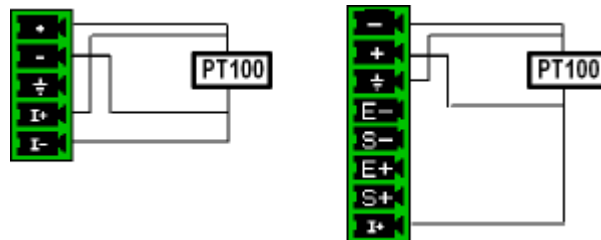

You only have to select the type of measurement PT100 2, 3 or 4 wires on the configuration of the corresponding channel; See chapter « **Channels** ». (PT100 3 wires not possible on the isolated strain gauge module input)

3.4.6. Intensity measurement

Isolated input module: it is possible to make intensity measurements with a **shunt** between the red and black poles of the treated input.

Non-isolated differential input module: it is possible to make intensity measurements with a **shunt** between the « + » and « - » poles of the treated input.

In this case, select the "**current**" type in the parameters of the selected channel.

Connect the measurement wires to the poles of the shunt.

The results are displayed directly in A or mA according to the caliber of the selected channel.

3.4.7. Earth

For measuring very low voltage values, the problem of the parasite voltages induced by electromagnetic fields or ordinary mode voltages are all the more important than the selected sensitivity is high. Hence, it is important that the outer cables are correctly settled.

There are various causes to such difficulties:

- uncertainty about the true origin of the disturbing voltages and impedances
- uncertainty about the parasite capacities of the circuits and cables
- no access to the point of injection of the ordinary mode voltage from the circuit providing the signal to record
- non-conformity of some appliances to the valid norms
- Sometimes, ignorance of the source impedances of the signals to record.

IT IS ADVISABLE TO RESPECT THE FOLLOWING PRESCRIPTIONS



1/ the **mechanical groundings** of every appliance must be **earthed**.

The mechanical grounding of the recorder is connected to the earth through the cord of the mains or thanks to the protective wire.

However, if the other appliances of the mounting do not include this possibility, it is advisable to gather their mechanical groundings with the one of the recorder, since it is available on a bush at the rear of the appliance.

2/ If the source of the signal to record has a **low internal impedance**, you will use **twisted wires**. If the source of the signal to record has high **internal impedance**, you will use **shielded wires**.

3/ When gathering the groundings of the various items of the measurement chain, you'd better check that there is no differential ground potentials between them in order to prevent any short-circuit. In case of doubt, use a voltmeter to measure it after placing a weak charge (i.e. 1 k Ω) between the poles.

3.5. Routine maintenance

The maintenance is not restricted to cleaning the outside of the appliance. Any other operation requires some qualified personal.



Unplug the appliance before any intervention.

Do not leave water flow into the appliance, to prevent any risk of electric shock.

Regularly clean the recorder in respect with the following instructions:

- use water and soap to cleanse the front and rear plates
- never use any product made of essence, benzene or alcohol that would attack the silk-screenings
- wipe with a soft lint-free cloth
- use an antistatic product to cleanse the screen

3.6. Calibration of the offsets

You can easily calibrate the inputs of the recorder for the offsets of voltages and thermocouples. This will remove any offsets present on different channels.

To do so:

- Let the appliance work for 20 minutes (ambient temperature between 20 and 25 °C).
- On each input, connect the « + » pole to the « - » pole (resp. red and black poles for the isolated inputs).
- Validate every channel 'ON'
- Push 
- At « **Option** », select « **Modify.** ».
- At « **Electrical calibration** », select « **Modify.** ».
- Eventually, select « **Calibration Offset** ». Then, you only have to select the channel(s) to calibrate.

By pressing « **Confirm** », you launch a calibration. It will last ca. 5 minutes

3.7. Default setup

You may restore the default factory settings to cancel any mistake in the calibration coefficients:

- Press 
- At « **Option** », select « **Modify.** ».
- At « **Electrical calibration** », select « **Modify.** ».
- Eventually, select « **Reload Factory coeff.** ».

By pressing « **Confirm** », you restore the default factory settings and give the date of initial plant start.

3.8. User mode

You can configure the recorder in User mode to lock some keys or functions of the appliance:

- Press



- At « **Option** », select « **Modif.** ».
- At « **User Mode** », select « **Modif.** ».
- Enter the password « **Sefram** », then select « **Confirm** ».

The User mode is then launched. To deselect it, you only have to follow the same process. The password is also « Sefram ». If you wish to change the password, contact the Sefram assistance.

3.9. Keyboard locking

You can also completely lock the recorder: no key will be available any more.

- Press

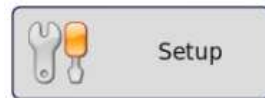

- At « **Option** », select « **Modif.** ».
- At « **Keypad locked** », select « **Modif.** ».

The keyboard will lock 5 seconds after pressing « **Confirm** ». All keys of the appliance will be locked. To unlock the recorder, you must push two or three times in a row on « **Home** ». This touch is displayed as a yellow padlock when the keyboard is locked.

4. USE

The chapter describes in details the effect of each key of the front side screen.

These actions are also available with a mouse of an external PC-type keyboard (see chapter **Presentation**)

The description of the keys and their actions is valid for each appliance. If not (specificities), the text will specify the type of appliance

4.1. “Mode Direct” key



Outline on paper of measured signals in real time (only for 8460)

- Use: immediate outline on paper, slow long-time data acquisition
- Possibilities: complex trigger of the outline, action after data acquisition, simultaneous record on internal memory or on a file

4.2. « Mode Memory » key



Quick data acquisition into internal memory of the measured signals

- use: quick short-time data acquisition (transitory)
- possibilities: complex start of the data acquisition, action after data acquisition, simultaneous record on a file

4.3. « Mode File » key



Quick data acquisitions on internal hard drive of the measured signals

- use: quick long-time data acquisition (only restricted to the size of the memory)
- possibilities: complex starts, action after the data acquisition, acquisition of very big amounts of data

4.4. « Go/No-go » key



Quick data acquisition into internal memory of the measured signals

- use: quick short-time data acquisition (transitory) to detect non-repetitive events
- possibilities: complex starts, in particular with exceeding pre-recorded template from a channel, action after the data acquisition, simultaneous record on a file

4.5. « User manual » key



This key gives you easy access to the user manual of the recorder.

4.6. « Power Analysis » key

The circuit analysis option makes it possible to measure powers and harmonics. The measured values can be displayed in real time or recorded. See chapter Circuit Analysis.

4.7. « Setup Analyzer » key



This key gives you access to the circuit analysis configuration. See chapter Circuit Analysis.

The circuit analysis option makes it possible to measure powers and harmonics. The measured values can be displayed in real time or recorded. See chapter Circuit Analysis.

4.8. « Setup » key

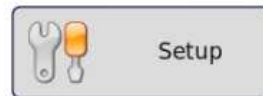

General configuration of the appliance, control of the alarm outputs, TCP/IP network address, calibration of the channels, updating of the internal software.

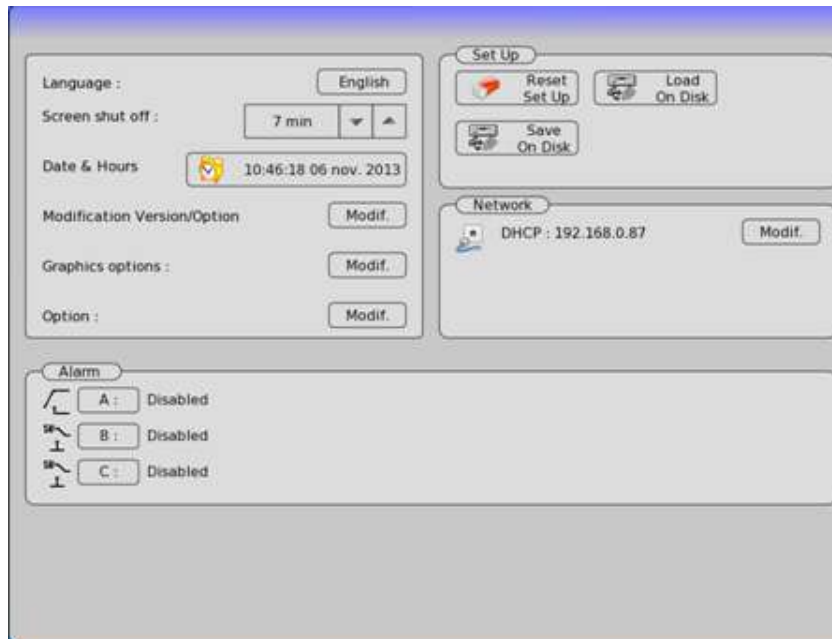

→ **Language:** selection of the language of the appliance

→ **Screen shut off:** turning off the backlighting of the LCD screen, configuration of the delay

- **Date & Hours:** date and hour of the appliance (for NTP, see 16.1.2)
- **Modification Version/Option:** updating the internal software (see chapter Presentation)
- **Additional options::**
 - **Bar graph: max on the right** to reverse the maximum and the minimum of the bar graph.
 - Possibility to switch to User mode
 - Lock the keyboard
 - Calibrate the offsets and restore the default factory coefficients (see 3. Set-up and precautions of use)
 - Calibrate the touch screen
 - You may also add an e-mail address to warn you when the data acquisition is over and test a network by adding the address...

You can also modify the text acquisition file structure from the menu. “File format→text”.

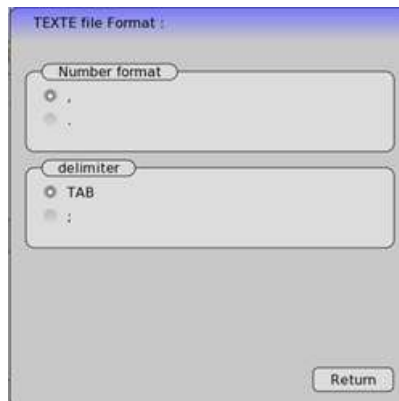

- **Number format:** Depending on the software you want to use to process the text file, the separator between the integer part and the decimal part could be a point or a coma.
- **Delimiter:** Character used to separate all the different data in the text file.

- **Network :** Change of the various IP and options
 - DHCP validity
 - IP address of the appliance
 - Address mask
 - Gateway address

→ **Set Up:** initialization of the appliance in its typical configuration, save / recovery into internal ROM, internal hard disk or USB stick



ATTENTION: the current configuration will be lost

→ **Alarm A:** use of the A alarm output (relay contact)

- **Disabled:** no condition controls the contact; it remains always open
- **Trigger:** control through a combination of analogical or logic channels on several thresholds (See chapter Triggers)
- **On the record triggering:** control through triggering of a data acquisition
- **Paper error:** control through lack of paper or opening of the printing block
- **Automatic add of markers in recordings**

In all cases, the contact is **open** if the condition is **true**.

→ **Alarm B:** use of the B alarm output (logic output 0-5 V)

In all cases, the contact is **low (0 V)** if the condition is **true**.

→ **Alarm C:** same as Alarm B

4.9. Channel key

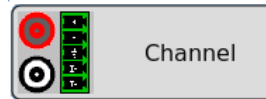

Configuration of the channels. After pressing this key, you select a module, then a channel to access its parameters. You can also access this menu by selecting a channel on the left of the screen.

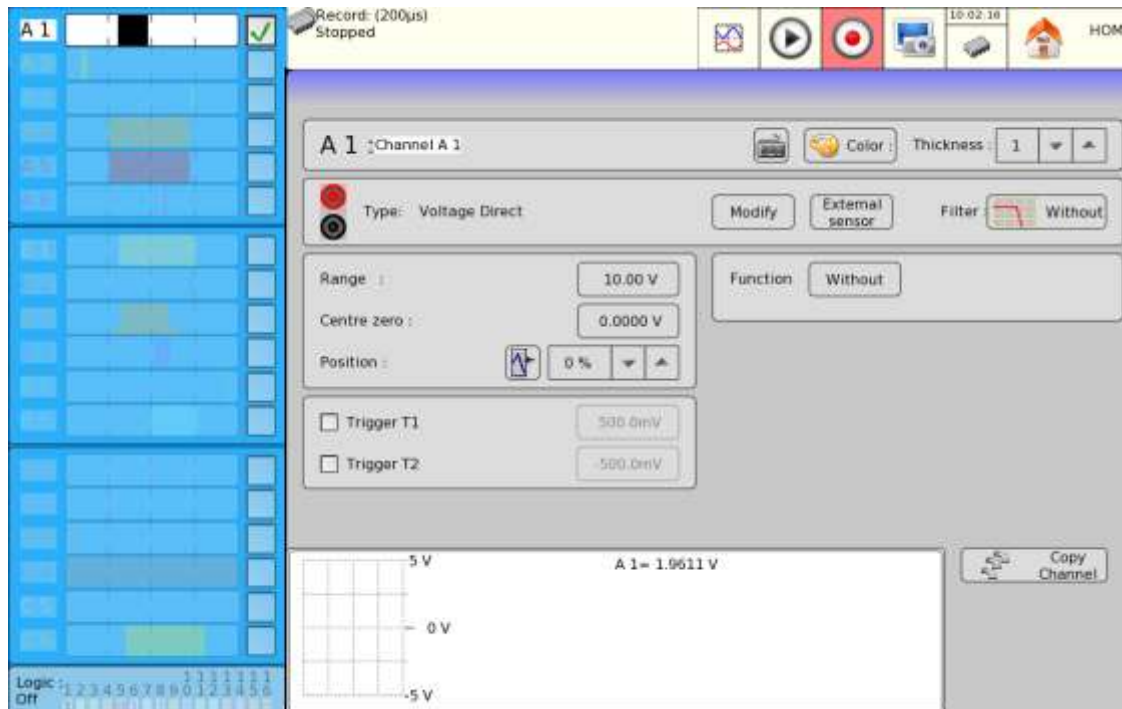

4.9.1. Analogical channels

- **Name of the channel:** give a name to the channel (26 characters max.)
- **Color:** allows you to change the color of the display on screen
- **Thickness:** changes the thickness of the measurement curve on screen and on paper, from 1 to 8 pixels
- **Type:** selection of the type of measurement on the input

For isolated universal input module

- voltage, intensity, frequency, thermocouple, PWM or counter
- direct, RMS, derivative or integral
- value of the shunt for intensity measurement
- selection of the type for thermocouple, compensation, unit

For multiplexed non-isolated input module

- voltage, intensity, thermocouple, PT100
- direct, RMS, derivative or integral
- value of the shunt for intensity measurement
- selection of the type for thermocouple, compensation, unit
- PT100 4-wire, 3-wire or 2-wire

For isolated strain gauge input module

- voltage, current, thermocouple, gauge, PT100, PT1000 (2-wire or 4-wire)
 - direct, RMS, derivative or integral
 - value of the shunt for intensity measurement
 - selection of the type for thermocouple, compensation, unit
 - voltage of the strain gauge bridge 2 V or 5 V
 - complete bridge or half bridge
 - initialization of the strain gauge (zeroing)
 - gauge coefficient
- Derivative of integral input: the user selects according to the signal with an integration time filter (this time is the same for all channels) and a channel filter.
In integral mode, a setup allows a zeroing of all channels.

→ **External sensor:** Assigns an external sensor to the selected channels

→ **Calibration Sensor:** For calibration of the minimum and maximum values for the selected channels

→ **Filter:** positioning of a filter on the input

-
- 10kHz, 1kHz, 100Hz, or numeric 1 filters
(According to the type of signal and to the card)

→ **Function:** assigns a mathematical function to the channel

- **Without:** no function
- **Change of unit:** changes the unit of the measurement made on the channel; you will be able to program a couple of dots X1, Y1 and X2, Y2 for a scaling
- **Calculation:** available mathematical functions, associated parameters and unit (the $ax+b$ function is identical to the change of unit, but instead of producing a couple of dots, you give a intercept (b) and the slope (a).

→ **Range:** settling of the caliber

The caliber is the measurement range matching the total width of the screen, where the channel is displayed.
You can settle finely the value of the caliber in order to take advantage of the whole width of the display on screen or paper.

→ **Centre zero:** zero adjustment of the channel

The zero (or center or offset) is the central value of the measurement.
You can settle finely the value of the caliber in order to take advantage of the whole width of the display on screen or paper.

N.B: When using a mathematical function or a scale change, the zero matches the zero in the selected unit.

→ **Position:** position of the zero on screen or paper, between -100 and 100%:

Ex. In RMS mode, it is interesting to have the zero at the minimum value (-100%): the maximum value will be equal to the caliber.

The lower zone of the LCD screen shows the min. and max. values (limits) possible for the measure values and the zero position.
A warning message shows up on the right when the analogical thresholds are out of measurable range.

→ **Trigger T1:** display of the position of the triggering threshold #1 on screen and paper

→ **Trigger T2:** same for the threshold #2

When the logarithm sensor option is selected the previous window lets appear new range of configurations:

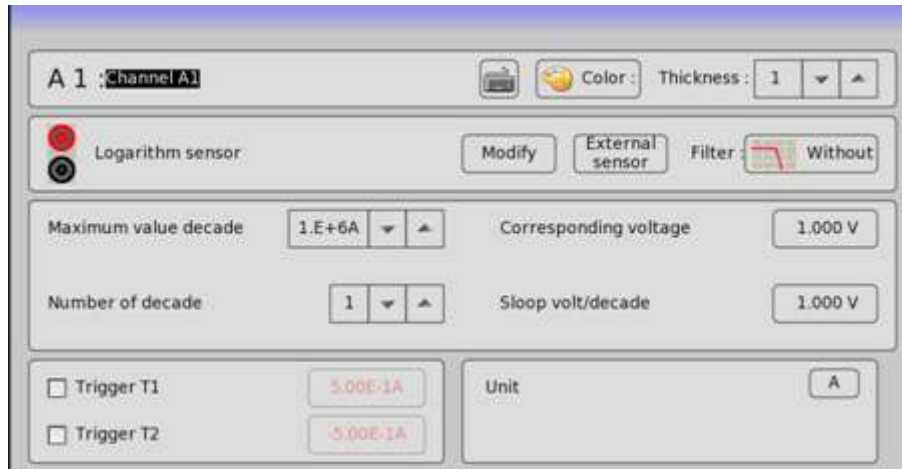

- ➔ **Maximum decade value:** Maximum in the ordinate axis
- ➔ **Number of decade:** Ordinate axis' division number.
- ➔ **Corresponding voltage:** Maximum voltage corresponding to the value entered in the **Maximum decade value** menu.
- ➔ **Slope volt per decade :** Slope associated with the sensor

4.9.2. Functions between channels

Up to 24 mathematical channels can be added from the menus below:

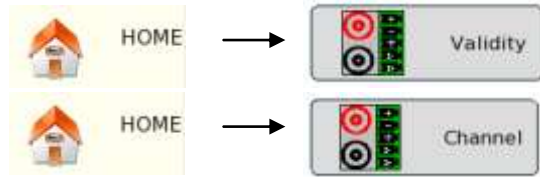

Enable/disable mathematical channels

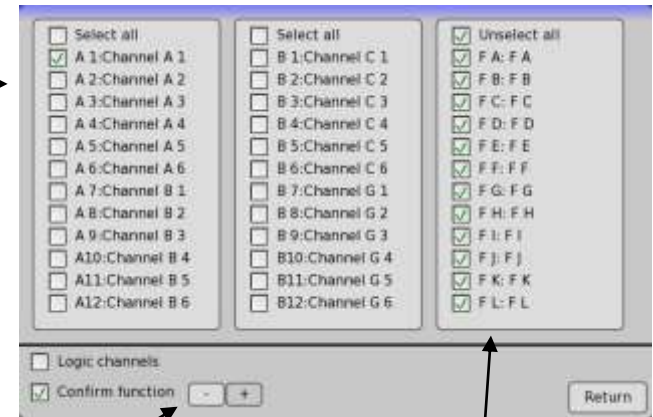

Add or delete a mathematical function

Mathematical function names from FA to FX

A mathematical function consists in a text file called script which contains the mathematical instructions. Function's script is accessible by clicking on its name in the bar graph.

Edit function parameters

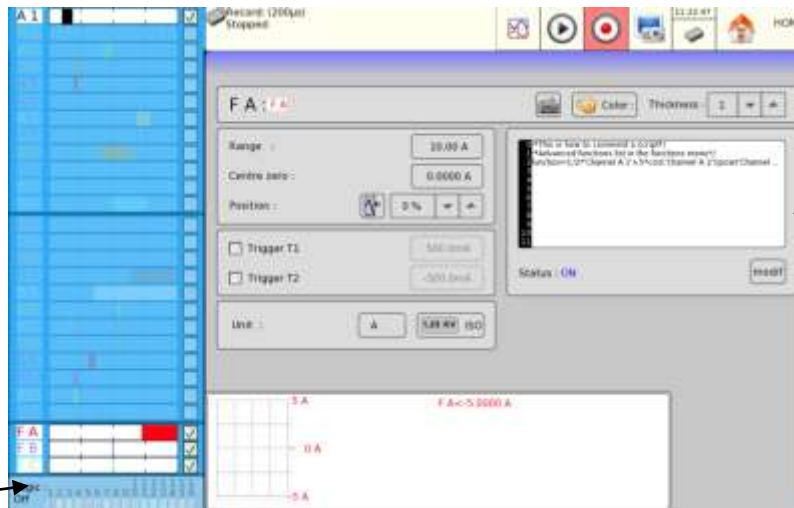

Click here to edit the script

4.9.3. Script editor

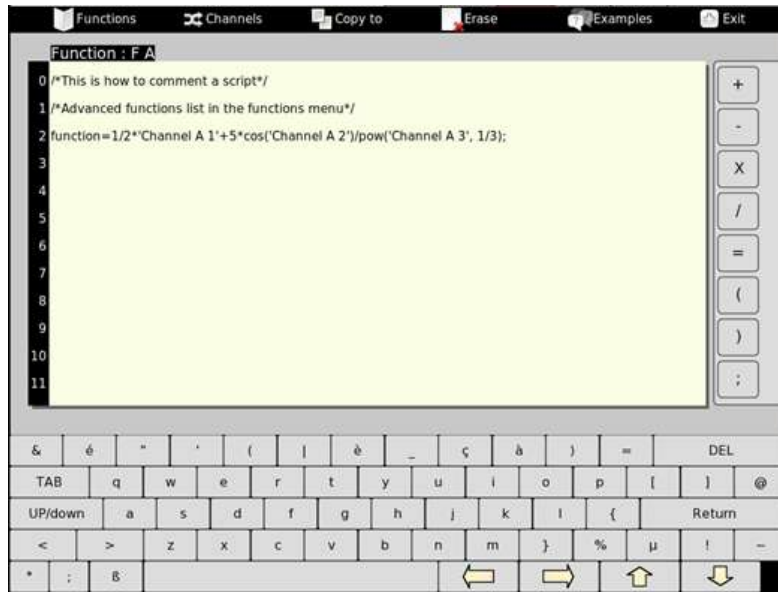

- **Functions:** Shortcut to add easily a basic mathematical function in the script
- **Channels:** Select in the list the channel name you want to add to the script
- **Copy to:** Copy the script and the configuration of the currently edited script to another mathematical channel
- **Erase :** Erase all the text of the currently edited script
- **Examples :** A basic script examples list
- **Exit:** Return to the channel configuration menu.

Scripts syntax

Mathematical scripts 'syntax is inherited from the programming language C. Programming scripts is a rigorous exercise which imply to respect some elementary rules to avoid error messages.

The three fundamental rules are:

- **Rule 1** : Every instructions or calculation must end with a semi-colon ;
- **Rule 2** : Channels name must be written between simple quotes like (the number of spaces must also be respected) 'Channel A1'
- **Rule 3** : Each variable must be declared only once with the keyword **var**. Example: **var** MyVariable=3;
- **Rule 4**: The result is stored in the current function channel by using the keyword **function**. Example : **function**=2;

By respecting these four rules, a basic script adding the Channel A1, Channel A2 and Channel A3 will look like:



```
Function : F A
0 function='Channel A 1'+ 'Channel A 2'+ 'Channel A 3';
```

Rule 4: The current channel is FA. The function keyword will thereby store the result in FA.

Rule 2: Channels name are between simple quotes

Rule 1: The calculation end with a ;

For long scripts it will be better to use intermediate variables to ease the maintenance or the future modifications. As mentioned in the rule 3, each variable must be declared before its use:

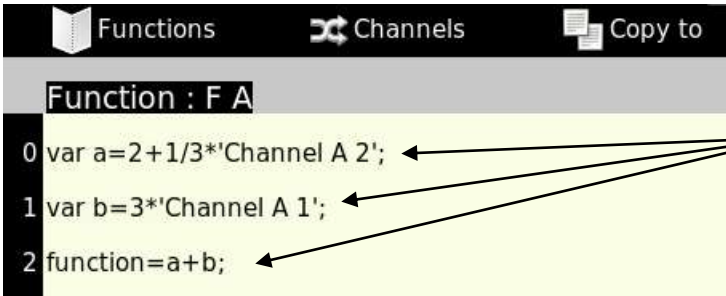

The screenshot shows a software editor with a toolbar containing 'Functions', 'Channels', and 'Copy to' icons. The editor displays a function definition:

```
Function : F A
0 var a=2+1/3*'Channel A 2';
1 var b=3*'Channel A 1';
2 function=a+b;
```

Annotations on the left side:

- Rule 3:** Variable a is declared (points to line 0)
- Rule 3:** Variable b is declared (points to line 1)

Annotation on the right side:

- Rule 1:** The semi-colons end the different calculation. (points to the semi-colons at the end of lines 0, 1, and 2)

Addition of a and b, the current function being FA the result is store in FA. The keyword var is no more used to refer to the already declared variable.



Variable names must only contain alphanumeric character and at the opposition of channels' names they must not be written between simple quotes.

In addition to the linear mathematical operators as +, -, x, /, it is possible to use non linear mathematical function with variables and channels. The list of these functions can be found in the menu Function in the editor's toolbar. A function is used by writing its name followed by a list of parameters between parentheses separated with comas.

Example: The channel rise to the 3th power:



The screenshot shows a software editor with a toolbar containing 'Functions', 'Channels', and 'Copy to' icons. The editor displays a function definition:

```
Function : F A
0 function=pow('Channel A 1',3);
```

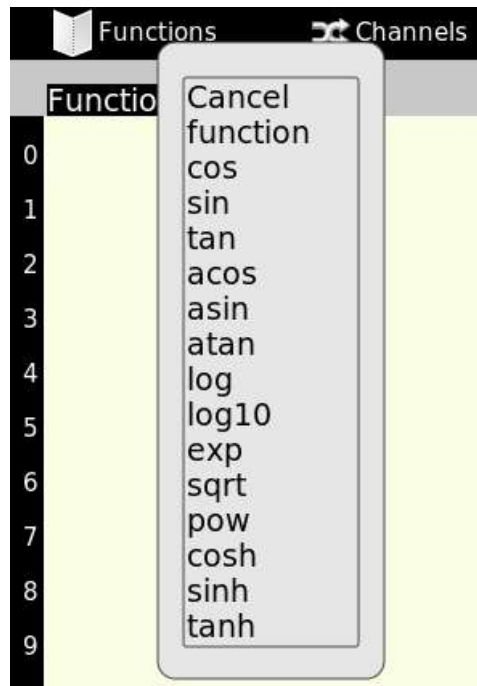

Mathematical functions	Syntax	Examples
cosinus	cos(b)	a=cos(b) ; or function=cos('A1') ;
sinus	sin(b)	a=sin(b) ; or function=sin('A1') ;
tangent	tan(b)	a=tan(b) ; or function=tan('A1') ;
arccosine	acos(b)	a=acos(b) ; or function=acos('A1') ;
arcsine	asin(b)	a=asin(b) ; or function=asin('A1') ;
arctangent	atan(b)	a=atan(b) ; or function=atan('A1') ;
Neperian logarithm	log(b)	a=log(b) ; or function=log('A1') ;
Decimal logarithm	log10(b)	a=log10(b) ; or function=log10('A1') ;
exponential	exp(b)	a=exp(b) ; or function=exp('A1') ;
Square root	sqrt(b)	a=sqrt(b) ; or function=sqrt('A1') ;
x^y	pow(x, y)	a=pow(x,y) ; or function=pow('A1',2) ;
Hyperbolic cosine	cosh(b)	a=cosh(b) ; or function=cosh('A1') ;
Hyperbolic sine	sinh(b)	a=sinh(b) ; or function=sinh('A1') ;
Hyperbolic tangent	tanh (b)	a=tanh(b) ; or function=tanh('A1') ;



It is possible to realize the nth root by using the mathematical equation $\sqrt[n]{x} = x^{1/n}$: hereby the 3th root of a variable X will be written in the script:

```
var X=2;
Y=pow(X, 1/3) ;
```

4.9.4. Error messages

Scripts start running as soon as the text editor is closed. If the current script contains an error, a contextual window will inform you at the editor's close.

Example: The lack of a semi-colon at the calculation end

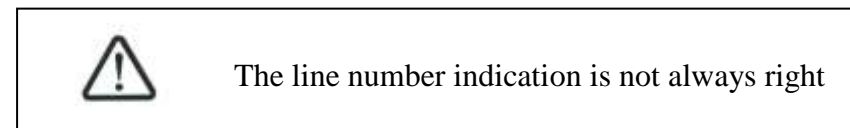
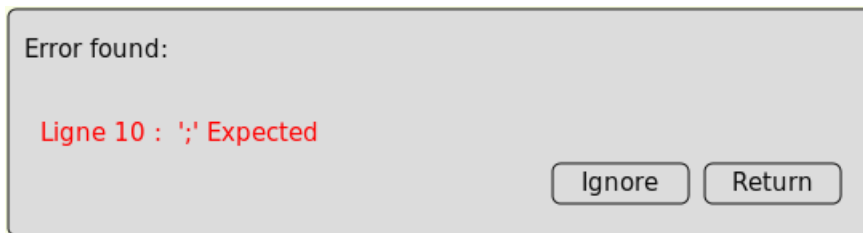

Common errors are

- ➔ Lack of a semi-colon
- ➔ A bad channel's name has been entered. Channel's names must be entered exactly as they were named (with the same number of spaces, the same case ...)
- ➔ A variable has not been declared
- ➔ A variable is used without being initialized
- ➔ The script depends on another script

Script editor advanced use

Adding channel's names to the script is eased by the menu **Channels** in the toolbar. With a simple click the selected name will appear in the script editor with the good structure, case and spaces.

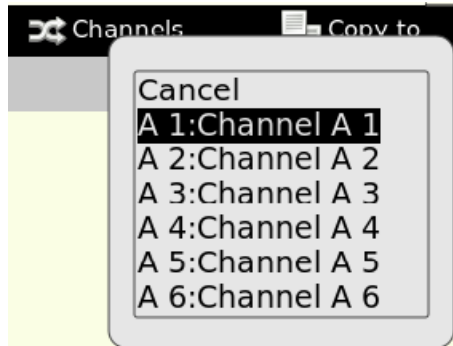

It is strongly advised to use this functionality instead of writing manually the channel name

The **replacement of a channel name** by another is accessible by clicking on an already written channel in the script editor and by choosing another in the menu Channels in the toolbar

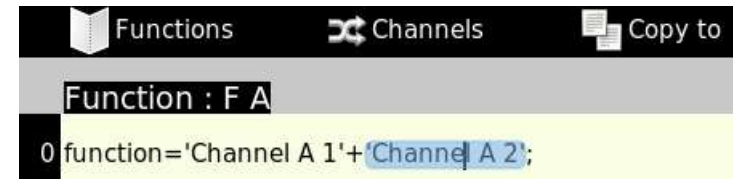

4.10. « Logic channels » key



Record: (200µs)
Stopped

Logic channels: 1

Color: [Color Selection]

Validity:

Ground : 5,17,4,3
12 V : 16
Alarm A : 15-2
Alarm B : 14
Alarm C : 1

Logical channel "1"

double thickness

Change color

1	1 (p13)	Vlog 1	0	9 (p 9)	
0	2 (p25)	Vlog 2	1	10 (p21)	
1	3 (p12)	Vlog 3	0	11 (p 8)	
1	4 (p24)	Vlog 4	0	12 (p20)	
1	5 (p11)		0	13 (p 7)	
1	6 (p23)		0	14 (p19)	
1	7 (p10)		0	15 (p 6)	
0	8 (p22)		0	16 (p18)	

Logic Off

- **Logic channels:** selection of the color of the channel on screen and its name
- **Validity:** validation of the data acquisition and printing of the logic channels. Selection of the number of logic channels between 1 and 16. Attention: the number of displayed channels may be lower if the height of the display zone is too low.
- **Logic channel "1":** doubles the thickness and selects a color for the channel when reaching the value 1. This function makes it clearer whether a channel is equal to 1 and not 0.

4.11. « Validity » key



Selection of the channels displayed on screen, printed on paper or recorded on memory or file.

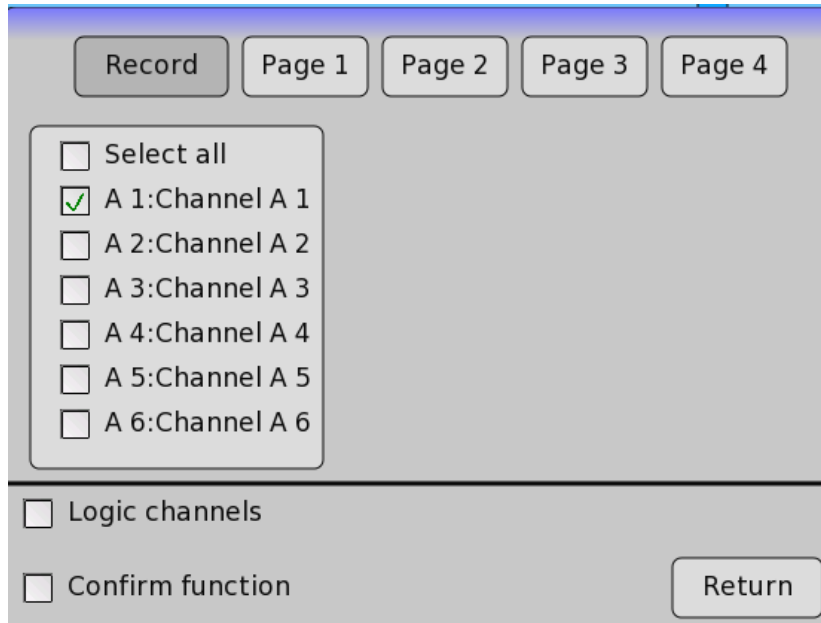

After pressing this key, select the channels you want to display on screen, print or record into the internal memory or on file. Check or Uncheck Select All to select all or unselect all a board's channels.

Proceed the same way to validate the functions between channels (treated as additional channels). Mathematical functions with script errors are printed in red.

You have 4 pages more for visualization of channels (in these pages only channel recorded is allowed)

4.12. « F (t) » key

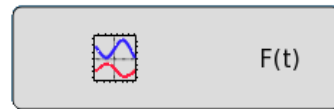

Real time display of the measurements on the LCD screen with 1000 dots.

The **F(t)** display mode (oscilloscope mode) allows you to visualize the validated channels in real time on screen, make measurements with cursors, add automatic measurements for amplitude and time, then save into a file or print on the acquisition paper when finished.

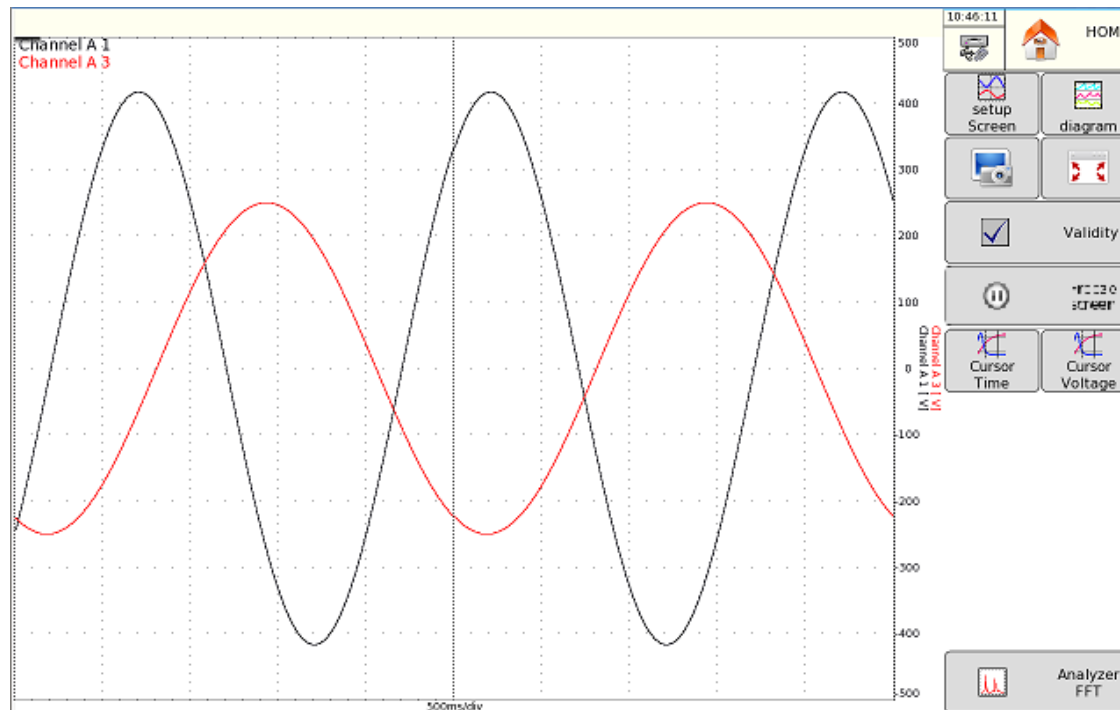

➔ **Setup Screen:** Configuration of the measurement display on screen

- Display **F(t)**, Display **XY**
- **Calculation validity** opens up a small window where you can select the number of channels concerned with the calculations and the selected function. You can move this window by pressing on the top left of it. You access the adjustments by pressing on the top right of it.

```
Voie A 4[Fréq] 25.00 Hz
Voie A 2[Max]= 15.943 V
Voie A 3[Pic, Pic] 2.3453 V
Voie A 4[Bas]=-3.7540 V
```

- **Vertical screen.**
- Display of the **nouns**, of the **digital** values, possibility to show up a window for the **digital** values.
- Possibility to customize the screen by changing the **background colors**, **reticules** and **cursors**. Possibility to display your own **background**.

→ **Diagram:** Display on screen of diagrams.

- You may display **logic channels outside the screens** above (**top**) or below (**bottom**) and adjust the **height** of the logic channels.
- **1/2 screens:** you can display diagrams on 1 or 2 screens
- **Number of screen:** change the number of the screen(s)
- You can display diagrams in **logarithmic mode**.
- **Number of divisions:** number of divisions of the screen or of the paper, up to 20.
- **Position of channel:** dispatch of the channels in the diagrams; select the channel you want and press the arrows to move it.

→ **Print screen:** You can print the displayed screen.

→ **Full screen mode:** **The menu is no more displayed and all the screen space is used by the graph. To return to a normal visualization click anywhere on the screen.**

→ **Validity:** gives you direct access to the « Validity » key to select the channels to display.

→ **Freeze screen:** freezes the measures on screen to make measurements with cursors, calculations, saves or to print measurement son screen (1000 dots) under F (t) mode.

You will also have access to:

- **Restart screen:** unfreezes the screen
- **Cursors Time** displays the horizontal cursors (2) to make time measurements on the display; move the cursor by selecting 1 or 2, then turn the code-selection switch, or click on the cursor with the mouse if connected
- **Cursors Voltage** displays the vertical cursors (2) to make amplitude measurements on the display; proceed as for the time cursors to move them. You may also change the caliber / zero to zoom or move your measurement on screen, zoom between cursors, manually select the values of the calibers and restore the original calibration.

By clicking on the window associated with time cursor, the way the information is displayed can be changed:

-**Values follow the curves:** Time values are directly displayed on the graph

-**Transparency:** Choose if curves or cursor values must be printed in the foreground.

-
- ➔ **Time base:** change the time base of scan under F(t) display from 100 μ s/div to 10min/div; each division includes 100 display dots, hence a sampling cadency of 1 Msample/s (1 μ s) at 0,16 sample/s (6 s).
 - ➔ **Auto Set:** Allows an auto set of the pending display.



Under F(t) mode (oscilloscope mode), the scan is in « triggered » mode for time bases < 100 ms/div, and in « scrolling » mode above.

In « triggered » mode, you can set the trigger of the displayed data acquisition. You can then select:

- the triggering channel
- the triggering active edge
- The vertical and horizontal positions of the trigger.

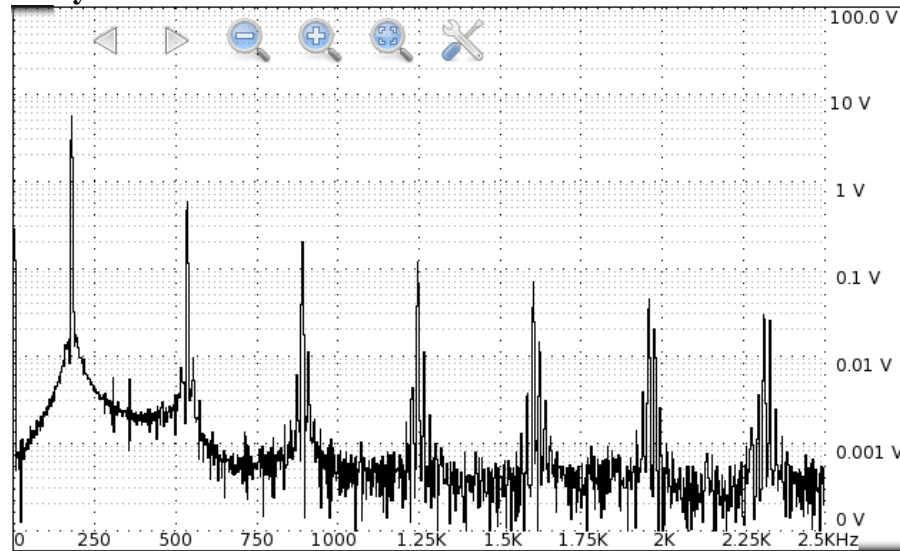
→ Analyzer FFT:

- This mode makes it possible to determine the frequency response of the selected signal. Pressing this key opens a window with a few settings:
- **Opacity:** you can adjust the opacity of the FFT analysis by using the arrows to increase or decrease
 - **Window:** you can adjust a window (Hann, Blackmann, Hamming) to increase the efficiency of the analysis
 - **Sample number:** to change the number of samples
 - **Sample:** to adjust the time of the signal

You can also change the parameters of the reticule and select the channel to analyze.

By pressing on the window, icon series appear and allow you to zoom, shift and directly call the window of data changes.
The FFT analysis can't be performed during the acquisition.

4.13. « XY » key

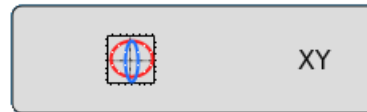

The **XY** display mode allows you to visualize the validated channels in real time on screen in comparison with each other. One of the channels defines the horizontal axis; the other channels define the dots according to the vertical axis.

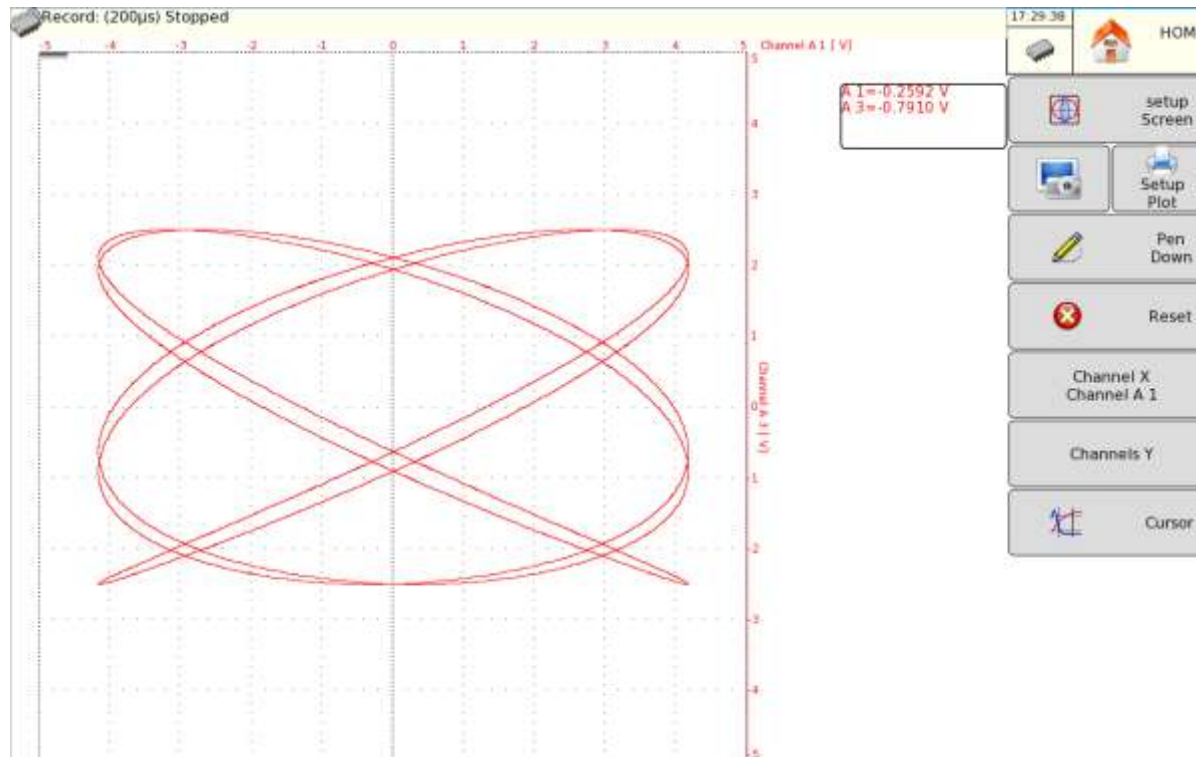

- ➔ **Setup Screen:** Configuration of the measurement display on screen
 - Visualization **F(t)**, Visualization **XY**
 - **Display boundary** to display the limits on screen.
 - **Dot** or **Vector**: Display either of the true dot or of the vector between the dots. If the frequency of the channels is higher than the frequency of dot display (0.1 Hz), you may see false pictures.
 - Possibility to customize the screen by changing the **background colors, reticules** and **cursors**. Possibility to display your own **background**.
 - **Print screen:** You can print the signal displayed on screen
- Setup Plot : Print options**

- ➔ **Pen down (yes or no):** If you press Yes, the current curves show up; if you press no, the display does not stop, but remains hidden (the display keeps on but is not visible)
- ➔ **Reset:** This key allows you to erase the curve and relaunch on a blank page
- ➔ **Channel X:** selection of the channel on the horizontal axis (screening)
- ➔ **Channel Y:** selection of the channel on the vertical axis; you may select several ones.
- ➔ **Cursor:** Displays the vertical and horizontal to make the measurements.

4.14. « Numeric » key



The **Numeric** display mode makes it possible to visualize the digital values of the validated channels in real time on screen. You can call directly channels by pressing on a channel window.

By pressing outside channels, you can choose:

- Channels filtration (avoid important visualization leaps)
- Page to visualize (page of channels to record or page 1 to 4)

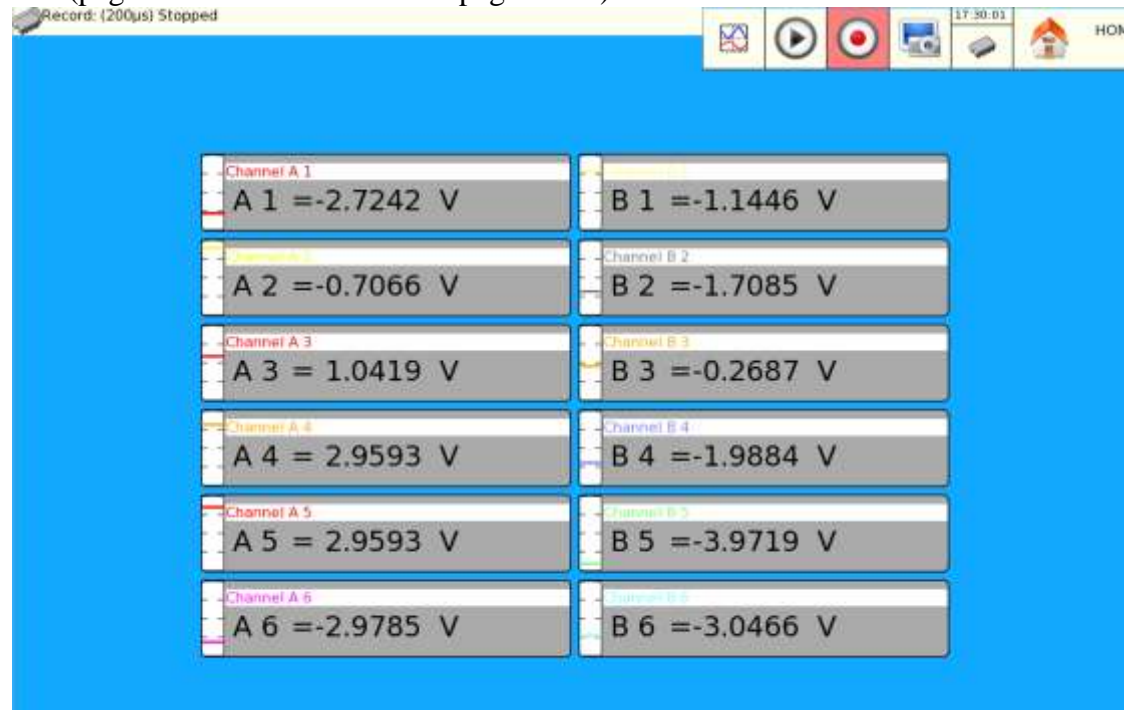

4.15. « Trigger » key

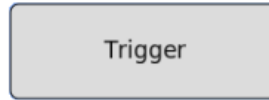

Channels data acquisition programming in Memory, File and Go/No-go modes.

Selection of the actions after data acquisition or display and validation in real time of the data back-up.

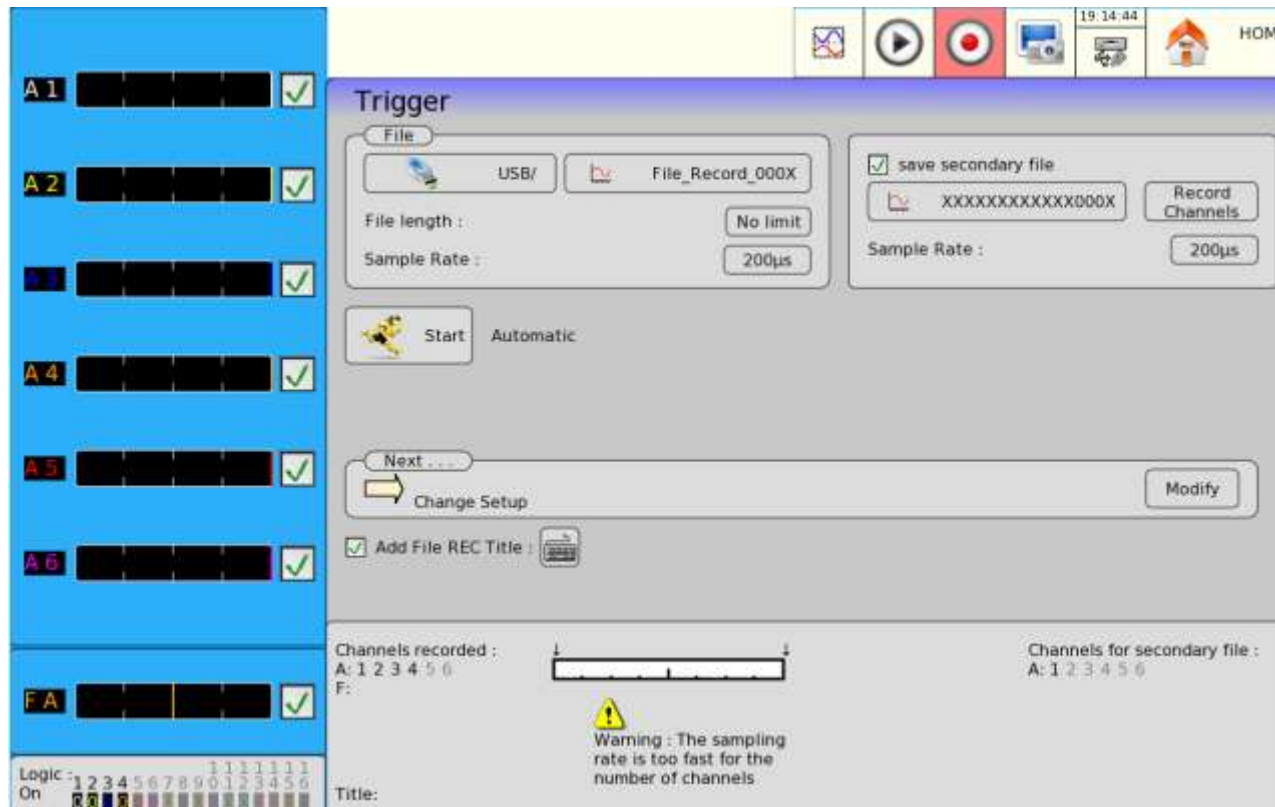

The programming of the triggers is different according to the current mode (Direct, Memory, Template or File).

See the chapter about the current mode for a more detailed description.

4.16. « Replay » key

Display on screen of the data acquisitions available in the internal memory or in files in the hard drive or a USB stick.



This function has nearly all the same commands as the display functions « **XY** » and « **F(t)** ». The only difference comes from « **File manager** » command that allows you to select a file or save the current display into a file and the « **Load set up** » menu that will load the configuration and the scripts associated to the displayed file.

→ Files manager:

- **Load file:** selection of the file to display
- **Save data to disk:** saves the current display into a file (internal memory / USB stick)



When the size of the acquisition data to display is important, it may take time to load and display dots.

In this case, the display is made in 2 steps:

- one quick phase for the display of the general shape of the curve : some dots may not appear
- one phase where all data acquisition dots are displayed: an indication of the percentage of advancement is displayed at the bottom of the screen

4.17. « Start/Stop » key



This key has various effects according to the current mode of the appliance.

Direct Mode: printing on paper if the trigger is set on manual Start; or appliance waiting for the trigger condition.

- **Memory** mode: launching the data acquisition into internal memory; the appliance waits for the **initial** trigger condition
- **Go/Nogo** mode: launching the data acquisition into internal memory; the appliance waits for the **initial** trigger condition
- **File** mode: launching the data acquisition to file; the appliance waits for the **initial** trigger condition

In any case, you only have to press the « Start/Stop » key once again to stop the record before the condition of **Stop**.



In **Memory**, **Go/Nogo** or **File** mode, the appliance switches automatically to the display of the current data acquisition

The following items appear on top left of the screen:

- the number of the current block, if possible
- the current sampling rate
- the state of acquisition (waiting for trigger, acquisition xx%, ...)
- the opening of a back-up file, if required

4.18. « Screen copy » key



You can copy the display on screen to a file:

The file will be created either onto an USB stick, if present, or onto the hard disk.

The name of the file will be PNGxxxxx.PNG (incrementing name).

On the hard disk, the files will be saved into the FolderPNG directory.

You can either copy this directory onto an USB stick or delete it. You can use a ftp link to download or erase the files.

4.19. « Home » key



This key gives you access to the main menu with all the keys.

5. TRIGGERS

This chapter describes all triggers available in this appliance.

You can use them with:

- « **Setup** » key, parameters « **Alarm A, B and C** »
- « **Trigger** » key, parameters « **Start** » and « **Stop** »

→ Edge / level trigger

- on an edge: you need a change of state
Example: channel A1, positive edge, threshold = 0 V: trigger when the signal turns from negative state to positive state.
- on a level: you don't need to pass a threshold
Example: channel A1, high level, threshold = 0 V: trigger if the signal is positive

Alarms only have level triggers.

→ Analog / Logical channels: trigger according to analogical or logic channels

- **Analog channel** (only one threshold) / **Combination Analog channel** (several thresholds):
 - triggering from only one channel and one threshold
 - or complex triggering from several channels and several thresholds; see description below.

Such complex triggering is only possible with analogical channels.

5.1. Trigger with Combination Analog channel

After selection of the triggering on analogical channels, the following line on screen allows you to set up the triggering condition. It depends on the selection between only one or several thresholds.

5.1.1. Analog channel (only one threshold)

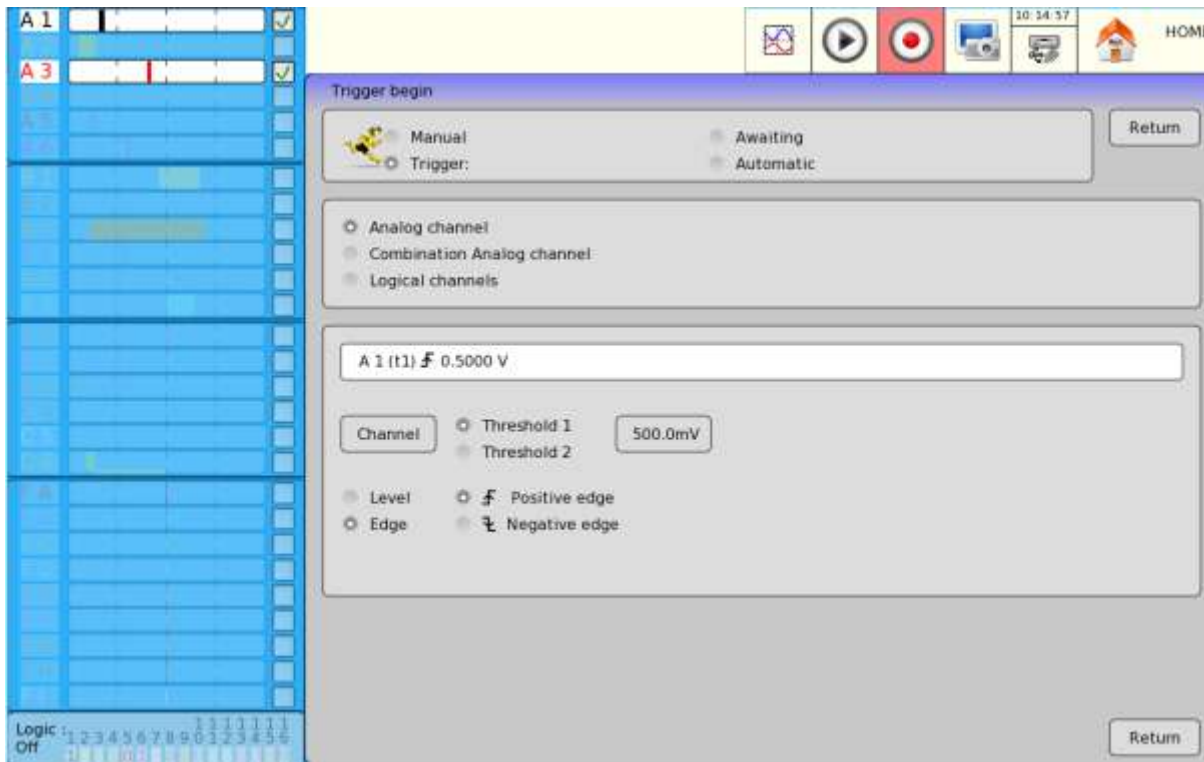

→ **Channel:** selection of the channel on which the triggering threshold is applied

→ **Threshold 1 / Threshold 2:** selection of the threshold to set up; each channel is tested against 2 thresholds. For example, you can program an initial condition on the channel A1 and the threshold 1, and a stop condition on the same channel A1 and the threshold 2.

→ **Level/Edge:**

- Level: Select of the level, either > superior, or < negative.
- Front: Selection of the active front of the channel against the threshold. For example: the condition A1 (s1)↑ 0.500A becomes TRUE when the channel A1 becomes higher than 0.5 A.

→ **Filter :**

When the level is selected , a filter can be added (from 1µs to 10s) .

5.1.2. Combination Analog channel (several thresholds)

After selection of a trigger according to Combination Analog channel, there are several ways to set up the complex triggering condition:

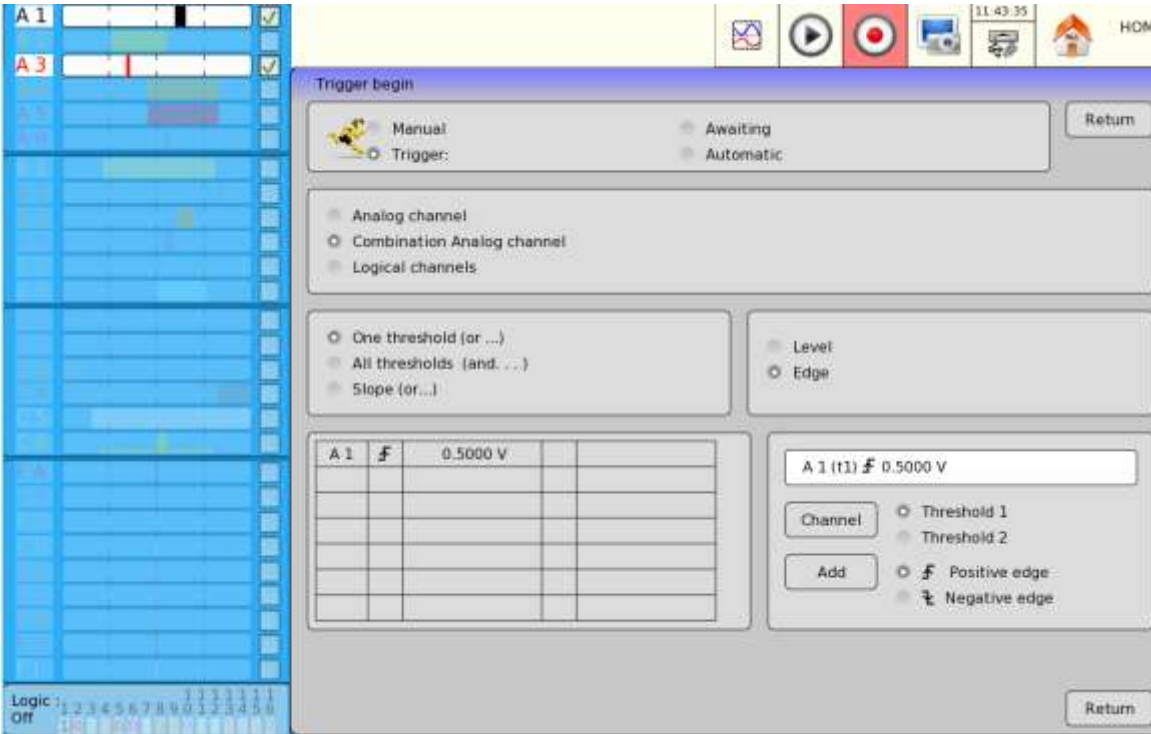

- ➔ One threshold (OR): the first achieved condition validates the trigger
- ➔ All thresholds (AND): all conditions must be simultaneously achieved to validate the trigger
- ➔ Slope (OR): trigger according to the slope of signals; the first achieved condition validates the trigger
- ➔ Channel: selection of the channel of the triggering threshold
- ➔ Threshold 1 / Threshold 2: selection of the threshold to set up; each channel is tested against 2 thresholds. For example, you can test an initial condition on the channel A1 and the Threshold 1, and a stop condition on the same channel A1 and the Threshold 2.
- ➔ Level / Edge:
 - Level: Selection of the level, either > superior, or < negative.
 - Edge: Selection of the active edge of the channel against the threshold. For example, the condition A1 (s1) ↑ 0.500A becomes TRUE when the channel A1 becomes higher than 0.5 A.

➔ **Filter :**
When the level is selected , a filter can be added (from 1µs to 10s) .

➔ **Add:** Allows you to add an additional channel. To suppress a channel, press its value (for example 0.00 V) in the table on the left and select « Erase ».

5.1.3. Threshold triggering

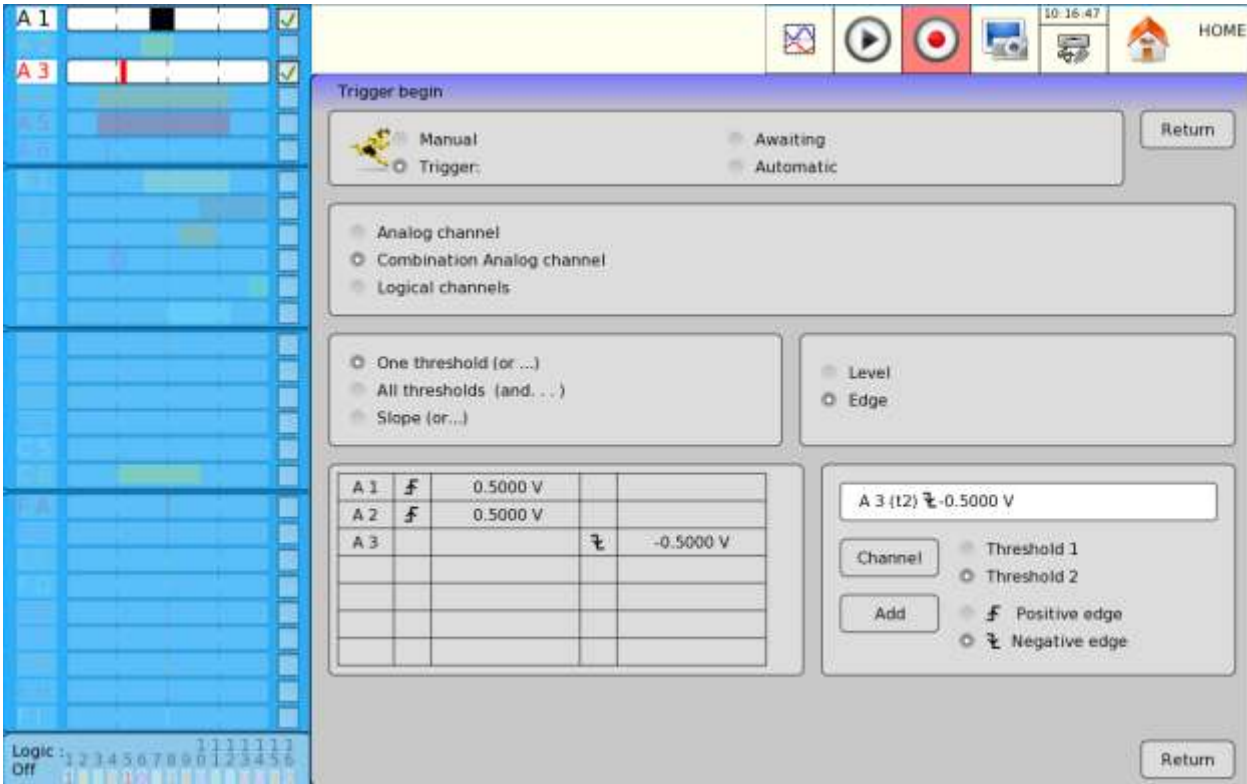

Example: the trigger here above is
Trigger if

- Channel A1 increasing and equal to the threshold S1 with value 0.500 A OR
- Channel A2 increasing and equal to the threshold S1 with value 0.500 V OR
- Channel A2 increasing and equal to the threshold S2 with value 0.500 V OR
- Channel A3 decreasing and equal to the threshold S1 with value 0.500 V

The same analysis is valid for the trigger AND (all thresholds).

5.1.4. Slope trigger

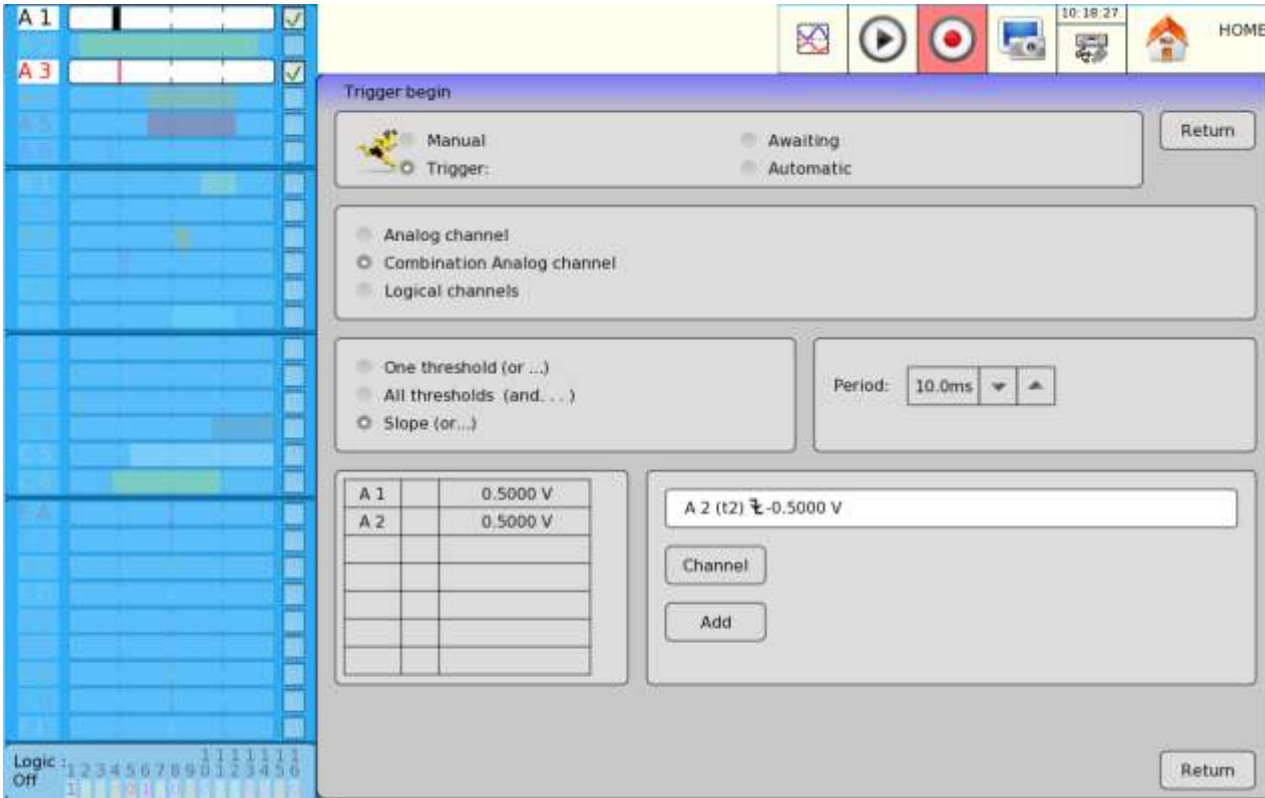

Example: the trigger here above is

Trigger if

- Channel A1 increasing with a positive slope of 0.500 V over a 1s period OR
- Channel A2 increasing with a positive slope of 0.500 V over a 1s period OR
- Channel A3 increasing with a positive slope of 0.500 V over a 1s period

This triggering mode is not used with alarms.

5.2. Trigger with Logical Channels

After selection of the triggering on Logic Channels, the following line allows you to set up the triggering condition.

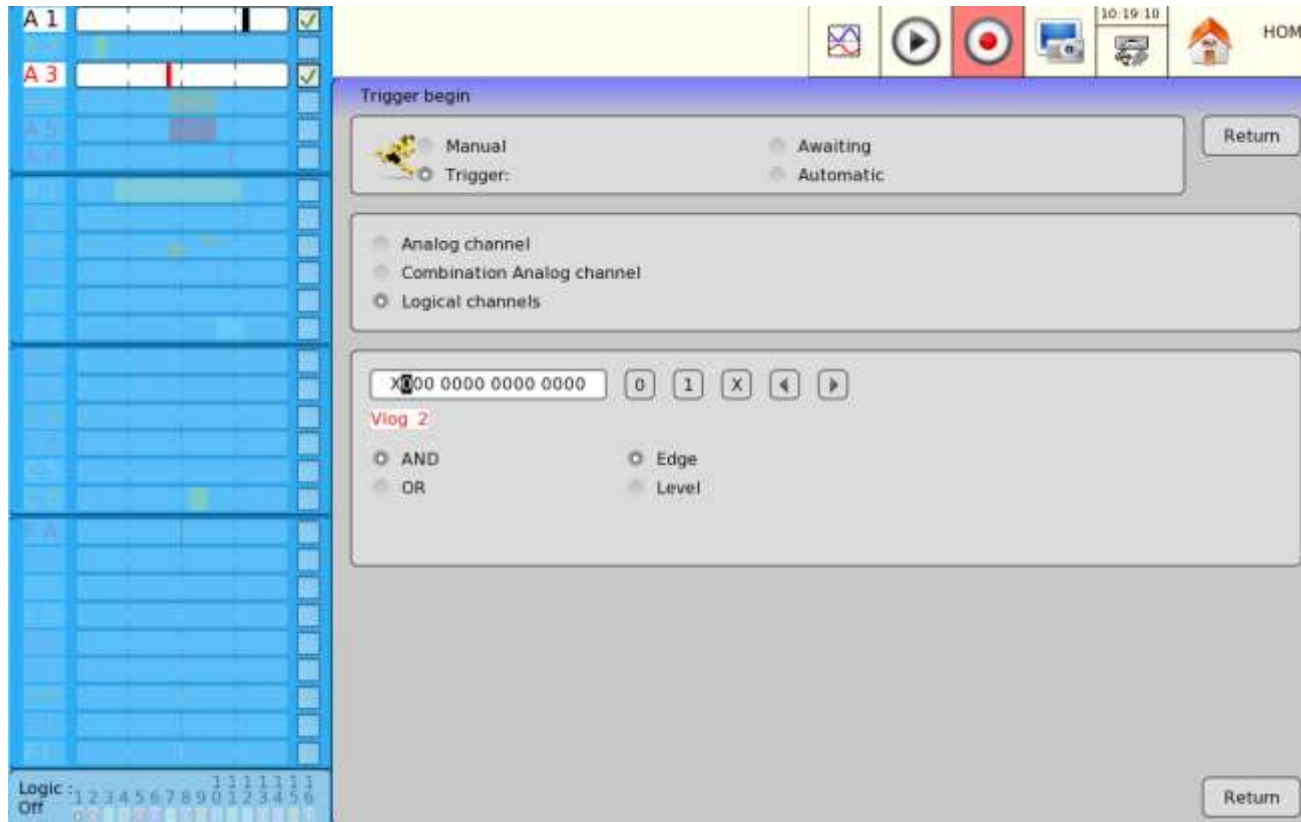

The 16 logic channels can be used in the triggering instruction:

- ➔ either active at 0 state (less than 1.6 volt)
- ➔ or active at 1 state (higher than 4.0 volts)
- ➔ or not used at X.

AND/OR: the mathematical function And/Or is applied on each channel.

6. MATHEMATICAL CALCULATIONS

You can make mathematical calculations on the results of the data acquisitions.

You can access them from the « **F(t)** » function and the « **Replay** » if a data acquisition is displayed on screen.

6.1. Definitions

Press the key « **Setup Screen** », and then select « **Calculation validity** » to open the calculation window. Press on top right of the window to access the set-up:

- **Opacity**: to adjust the level of opacity of the window
- **Mathematical calculation**: to set the number of simultaneous calculations (max. 6).
- Select the **name of the channels** to which you want to assign the calculation function, and then select the **calculation function** for each channel.

20 various mathematical calculations are suggested in 3 categories:

- **Amplitude**: min. value, max value, peak to peak, low, high, amplitude, on oscillations
- **Time**: frequency, period, increase time, decrease time, positive width, negative width, positive and negative cyclic ratio
- **Calculation**: average, cyclic average, RMS and cyclic RMS

Up to **6 calculations** can be displayed on screen simultaneously.

The values are displayed in rectangles above the diagrams where appear:

- the number of the channel (with the corresponding color)
- the type of calculation
- the value of calculation

The calculations are made in real time; their result is updated every 300 ms.

The calculation is made on the 1000 dots displayed on screen. Hence, the time resolution is 0.1%.









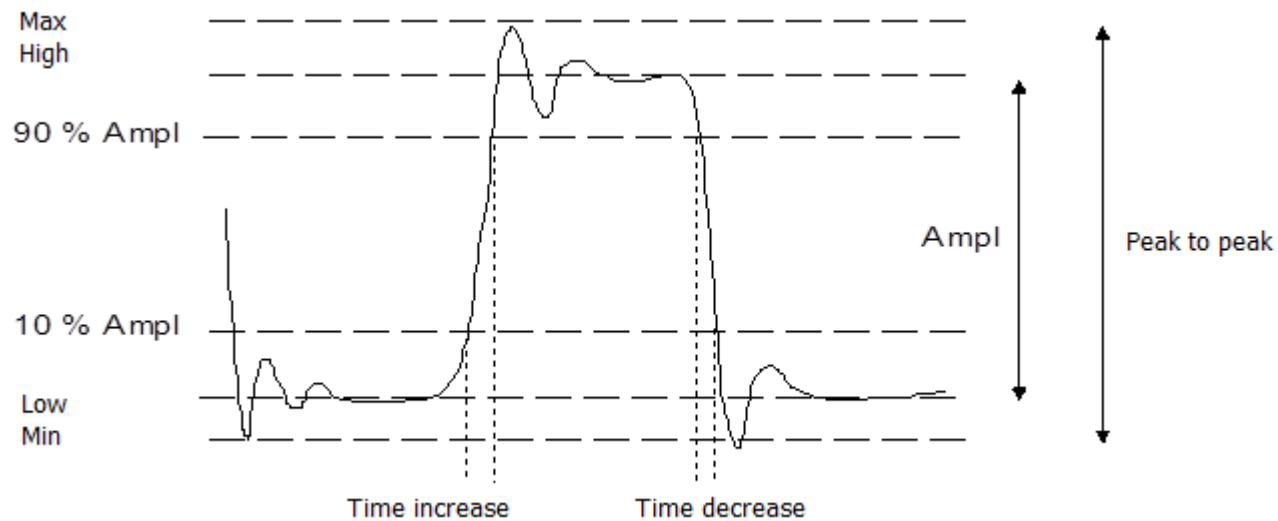

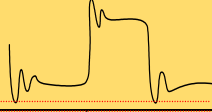
Calculations can be made on every channel. However, you cannot made calculations:

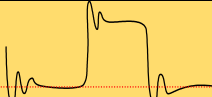
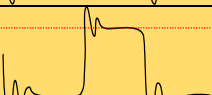
- On addition channels functions of other channels
(Example $F3=A1+B2$)
- If the channels have not been recorded (validation ON/OFF)

6.2. Types de calculations

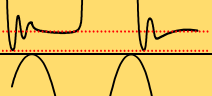
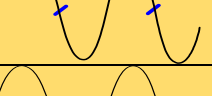

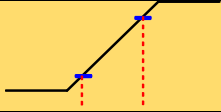
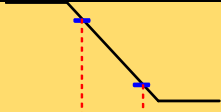
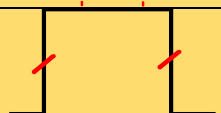
Explicative scheme	Math. function	Calculation	Observation
	Minimum		The lowest value of the negative voltage
	Maximum		The highest value of the positive voltage
	Peak to Peak	Max-Min	
	Low		The most frequent value under the median
	High		The most frequent value above the median
	Amplitude	High-Low	
	Positive over-oscillation	$\frac{Max - High}{Amplitude} \times 100$	
	Negative over-oscillation	$\frac{Low - Min}{Amplitude} \times 100$	
	Frequency	$\frac{1}{Period}$	Average frequency
	Period	$\frac{Duration\ of\ N\ periods}{N}$	Average duration of a complete cycle as calculated on as many periods as possible

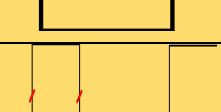
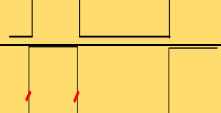
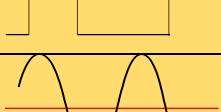
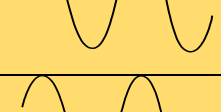
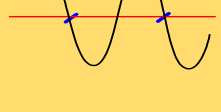
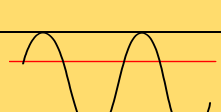
	Time of increase	$T_1 = 10\%$ Amplitude $T_2 = 90\%$ Amplitude Time of increase = $T_2 - T_1$	
	Time of decrease	$T_1 = 90\%$ Amplitude $T_2 = 10\%$ Amplitude Time of decrease = $T_2 - T_1$	
	Positive impulsion width	Measurement of the time of the <u>1st positive impulsion</u> made at 50% of the amplitude	
	Negative impulsion width	Measurement of the time of the <u>1st negative impulsion</u> made at 50% of the amplitude	
	Positive cyclic ratio	$\frac{\text{positive impulsion duration}}{\text{period}}$	
	Negative cyclic ratio	$\frac{\text{negative impulsion duration}}{\text{period}}$	
	Average	$Moy = \frac{1}{N} \times \sum_{i=1}^N V_i$ N: total number of dots	Calculation on the whole graphic window
	Cyclic average	$Moy = \frac{1}{(N_2 - N_1)} \times \sum_{i=N_1}^{N_2} V_i$ $N_2 - N_1$: number of dots between full periods	Calculation on as many periods as possible
	RMS	$RMS = \sqrt{\frac{1}{N} \sum_{i=1}^N (V_i)^2}$	Calculation on the whole graphic window
	Cyclic RMS	$RMS = \sqrt{\frac{1}{(N_2 - N_1)} \sum_{i=N_1}^{N_2} (V_i)^2}$	

7. DIRECT MODE

This chapter describes the **Direct mode** of the 8460 recorder made for tracing performed measures on channels on thermal paper in real time. The outline starts and stops can be triggered under several conditions. A simultaneous saving of measures in the internal memory or in a file can be enabled.



This mode doesn't exist for 1600/800 models.

7.1. Outline setup

- **Title** : title programming (124 characters max.) for the print. It appears at the top of the paper.
- **Time** : time reference type, printed at the beginning of the outline and at each annotation.
 - absolute: hour and date in real time.
 - relative: set to zero at the beginning of the outline, inscription of the past time at each new annotation.
- **Reticule** : definition of the reticule traced on the paper
 - none, every 5 mm, 10 mm or by an integer number of divisions
 - thin or big, that is to say with or without sub-divisions
- **Pole** : possibility of writing pole of each channel (min-max), and the position of zero at the end of the outline too.

Annotation: possibility of having annotations during the printing
- Without

- Start of the outline: you choose what you want to display, the channel name, the channel number, the annotation type (with, value, size, scale (/cm), min/max).
- On alarm: always choosing what you want to display, you add an alarm (A, B or C).
- Length of the paper: you also can choose a length of paper for the print.

For the annotations, the following possibilities are proposed:

- Number of channels (follows the curves)
- Name of channels with an annotation type
- The position of annotations is automatic or adjustable: in that case, you choose the position of the annotation of each channel in the configuration page of channels
- Automatic outline of a BMP file (bitmap Windows): files have to be in monochrome (2000 dots maximum of high). The file has to be on the disk. You can copy the file via an USB or via an ftp link. The first point of the file (upper left corner) will be placed at the bottom of the outline.

Manual outline

- Outline of cartridge
- Outline of a BMP format file

7.2. Outline triggering

Press on “trigger” key.

Programming of starting and stopping conditions of the outline.

Choosing actions after the outline and the validation of the saving in real time.

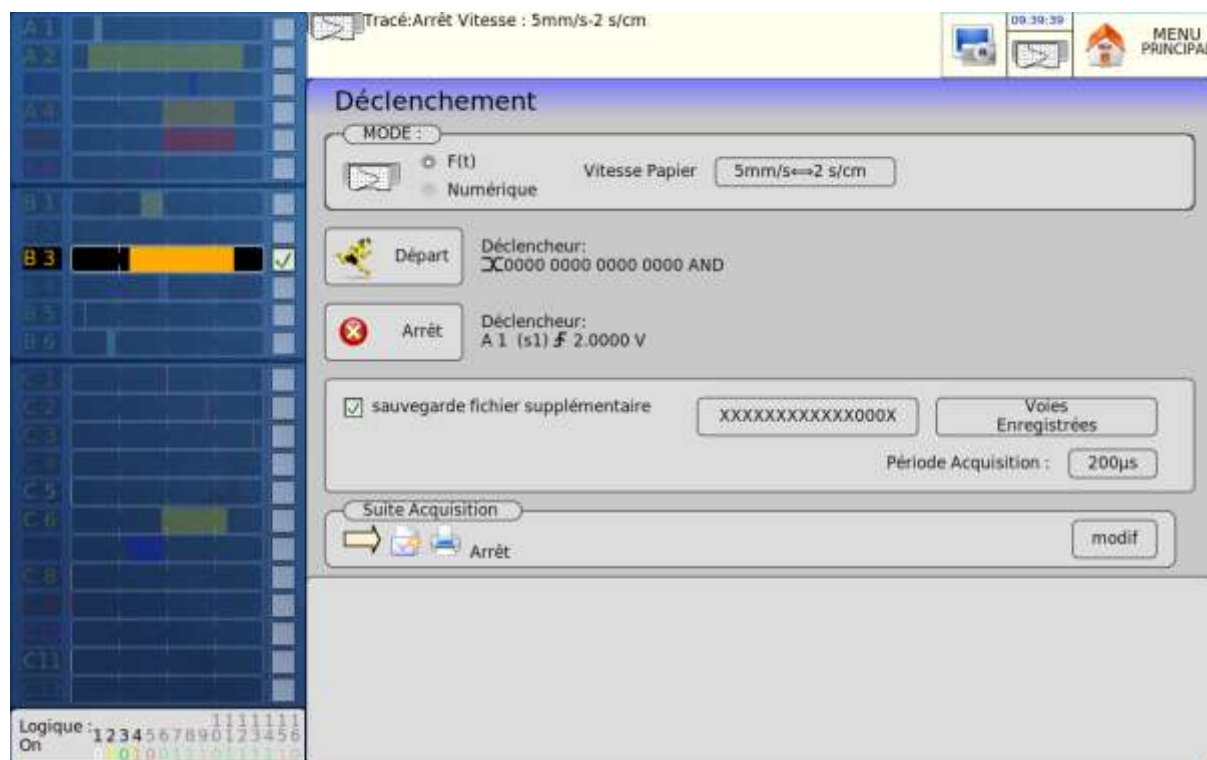

Mode: selection of printing mode

- F(t): printing of a graph depending on time
- Numeric: printing of numeric values of measures in a table

Speed of the paper: speed of the print

- Internal regular lead of 1mm/h to 100 mm/s
- External regular lead by the 16 logic channel

Start: starting condition of the outline

- Manual: by the “recorder” key
- Trigger: on combination of analogical or logic channels (see chapter 5 Trigger)
- Waiting: after a period or at a precise date and hour

Stop: stopping condition of the outline

-
- Manual: by the “recorder” key
 - Trigger: on combination of analogical or logic channels (see chapter 6 Trigger)
 - Waiting: after a period or at a precise date and hour
 - Length of the paper: after the writing of a programmed length of paper

Back-up of additional file: simultaneous recording of measures on a file (if the file is valid)

- Name of the file: place and name of the backup file
- Recorded channels: shortcut for “Valid” key to select channels to record.
- Acquisition period: sample speed of channels

See chapter Mode File to know the limits of recordings on a file.

Rest of acquisition: actions after the end of simultaneous acquisition in memory

- Sending an email: this option will be available if you added a mail address before in “additional options” in the “SET UP” menu.
- Stop: no action
- Rearmament: launches the outline; waits for the starting condition
- Change setup : loading of a configuration and waiting for the trigger



If a speed was programmed before the start, the paper will move with this speed during the waiting of the trigger.

User can force the trigger at any moment by pressing the “recorder” key during the waiting of the starting trigger.

If the outline is in progress, pressing on this key will cause the stop of the outline.

In the case of a mains stop during the outline, the recorder starts in the same condition (waiting or outline) at the restarting

7.3. Rearmament of the outline

In rearmament mode, the waiting for the start of the outline is launched automatically when the stopping conditions occur. To stop the cycle, force the stop of the outline by pressing the “recorder” button during the outline in progress.

7.4. Information writings

At the beginning of each outline, the date, hour and programmed title appear at the bottom of the paper. The number of each channel appears on the outline.

8. MEMORY MODE

This chapter describes the **Memory Mode** to record the calculations made on the channels in real time into internal memory.

You can launch the data acquisition under various conditions. The acquisition **Stops** when the measures exceed a previous acquisition as defined as a **Go/NoGo**.

You can activate a simultaneous back-up of the measurements onto a file.

8.1. Set-up and triggering of the data acquisition

Press the « **Trigger** » key.

Set-up of the data acquisition into internal memory with a template.

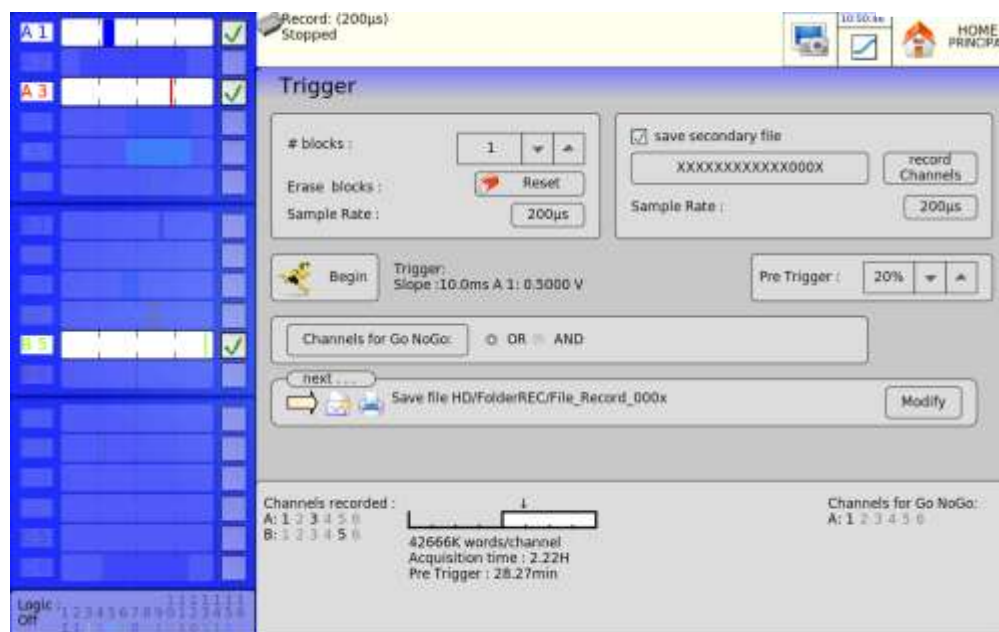

- **Number of blocks:** parting of the internal memory into blocks
 - 1, 2, 4, 8, 16, 32, 64 or 128
 - Erase blocks: deleting all blocks: the pending block is #1
- **Sample Rate:** sampling rate of the channels
 - advancement paced **internally** from **1 µs to 10 min**
 - advancement paced **externally** through the **logic channel 16**
- **save secondary file:** simultaneous record of the measurements on a file
 - **Without:** no simultaneous back-up
 - **With:**
 - **File name:** directory and name of the back-up file
 - **Record channels:** shortcut of the « **Validity** » key to select the channels to record
 - **Sample Rate:** sampling rate of the channels

-
- **Start:** Start condition of the data acquisition
 - **Manual:** with the F2 key « **Forcing Trigger** »
 - **Trigger:** on combination of analogical and logic channels ; See chapter **Triggers**
 - **Awaiting:** after a delay or at a specific date and hour
 - **Automatic:** immediate; automatic stop when the block is full

 - **Pre trigger:** set-up of the position of the start trigger of the data acquisition
 - acquisition before and after triggering; See chapter « Memory mode »

 - **Channels for Go NoGo:** selection of the channels to compare with the template (when pressing the « Go/Nogo channels » key, you have access to the definition of the template)



« **Impossible** » shows up when all possibilities of back-up are exceeded: reduce the sample rate or the number of channels



See chapter **File Mode** to know the restrictions of the record on file.

- **Next . . . :** actions after the end of the data acquisition
 - **Save in file:** save the data acquisition to a file of the real time back-up has not been validated (or is impossible)
 - **Send Email:** this option shows up if you previously added an e-mail address in the « **Additional Options** » in the « **Setup** » menu
 - **Plot:** drawing the simultaneous data acquisition into memory
 - **Stop:** no action
 - **Rearm:** restarts the acquisition; return to waiting the launching condition
 - **Change setup:** loading a configuration; return to waiting the launching condition

8.2. Sampling period

When input signals frequency is too high, it is necessary save the measured signals with a high acquisition speed: it is the Memory mode. The sampling consists in taking the instantaneous value of a signal with regular intervals, each of these values is saved in the memory.

For a satisfactory periodic signal, you must select a sampling period compatible with the signals frequency on the input terminals of the recorder.



A 10 points definition per signal period is a minimum for getting a satisfactory drawing.

8.3. Internal memory _ blocks

The memory available on the recorder can be separated in blocks which are filled successively during each acquisition.

The acquisition depth is $N/(B*V)$

N= total memory

B= number of block

V= number of channel to get

Example: 128 Msamples memory, 32 blocks and 4 'ON' channels, so

$N = 128,000,000 / (16 * 3) = 1,000,000$ samples/channels

Every new acquisition is placed automatically in the first free block (in ascending direction).

When all acquisitions are busy, a new one causes the gap of previous blocks in the N-1 block; the first block will be lost.

The new acquisition, as a result, will take the place of the last block.

8.4. Trigger position

The acquisition in a memory block is based on the principle of “cine memory”:

- the memory is filled from the starting condition
- the memory is filled as long as the stopping condition is not valid; if the memory is full, the filling starts at the beginning of the memory zone (block)

The memory block always has the N last samples.

User can select the moment when the present samples in memory will be freeze; to do this, he has to define a period which separates the trigger moment of the beginning of the effective back-up.

This period can be positive or negative, so the memorized samples can be before, after, or on both sides of the trigger moment.

You can also not inhibit the trigger: it allows you to test the trigger during the pre triggering phase in case of the trigger arrives before the end of this phase. In case of repetitive signals, the trigger is inhibited.

Back up with a period of -50%

In relation with the beginning of the memory

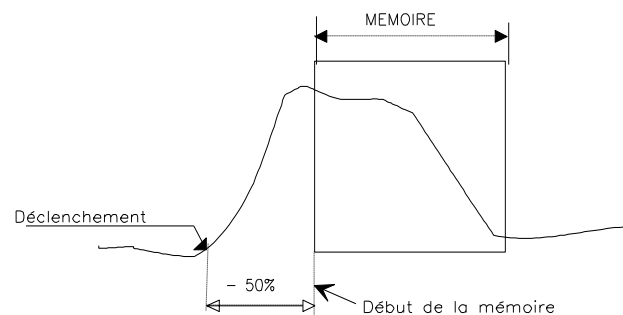

Back up with a period of +50%

In relation with the beginning of the memory

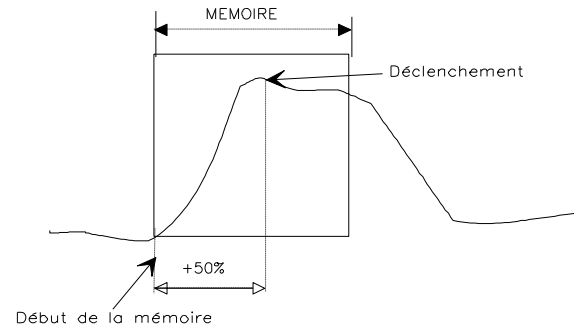

8.5. Double Trigger Mode

In this mode, a starting trigger and a stopping trigger are used.

You will record measures between these two triggers.

The acquisition will stop automatically:

- when the stopping condition is valid
- when the memory block is full



An information window sums the general setup of the acquisition:

- channels and functions between validated channels for the acquisition
- number of points per channels (function of the number of blocks)
- acquisition total time (function of acquisition speed)
- trigger position (function of pre triggering)

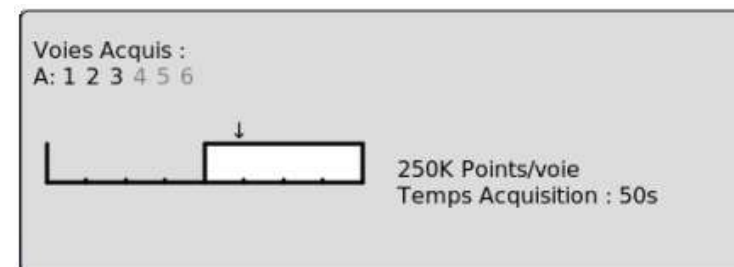

8.6. Recording



The acquisition launch is performed by pressing the “recording” key.

The following information appears on the top and on the left of the screen:

- the number of block in progress if there is some
- the current sampling speed
- The acquisition condition (waiting of the trigger, filling xx %...)
- the opening of a file of back up, if there is some



If the acquisition time is below 2 minutes, the total acquisition is visualized.

In that case, you cannot exit from this page: the acquisition must stop to change of menu.



For long acquisition times, you can zoom on a part of the data or change of page.

When you change the menu page, you can return to acquisition by pressing the “recording” button.

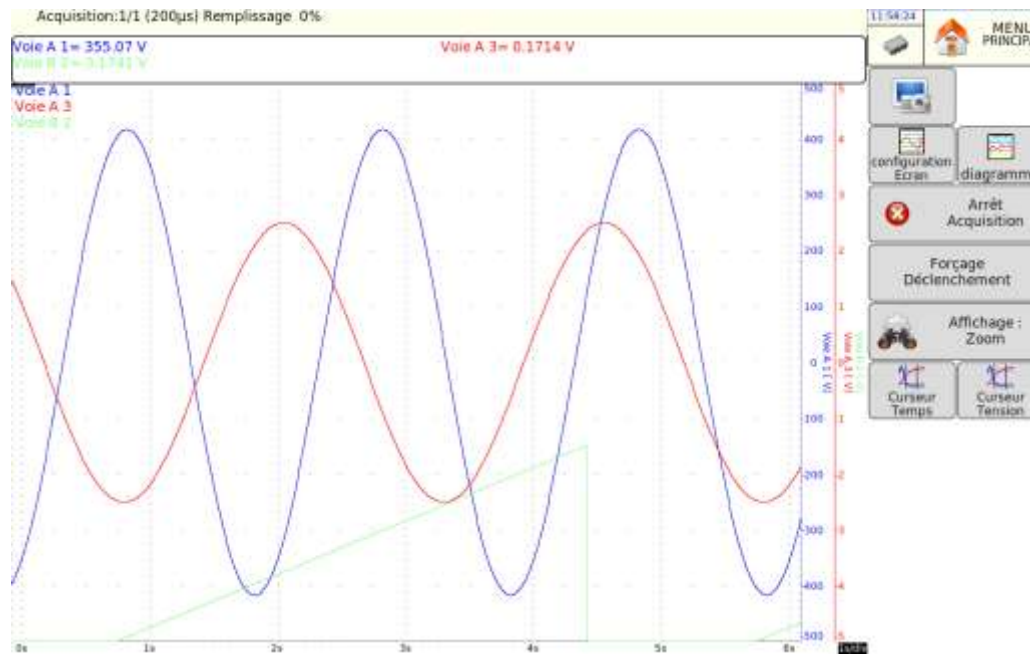

Additional keys of the menu:

➔ Display :

- Total : the entire memory depth is displayed and refreshed during acquisition
- Zoom : the filling rate allows you to know the acquisition condition, you can access to time and voltage cursors.

• Running : presents the acquisition in progress.

➔ Force the triggering: cause the channel triggering.



You cannot visualize another block than the block in progress, perform an outline or save on the acquisition file as long as the acquisition is not over.

At the end of acquisition, the appliance switches to the mode “memory output”.

8.7. Memory output

Visualization of acquisitions available in internal memory or in files.
Possibility of launching an outline on acquisition paper.

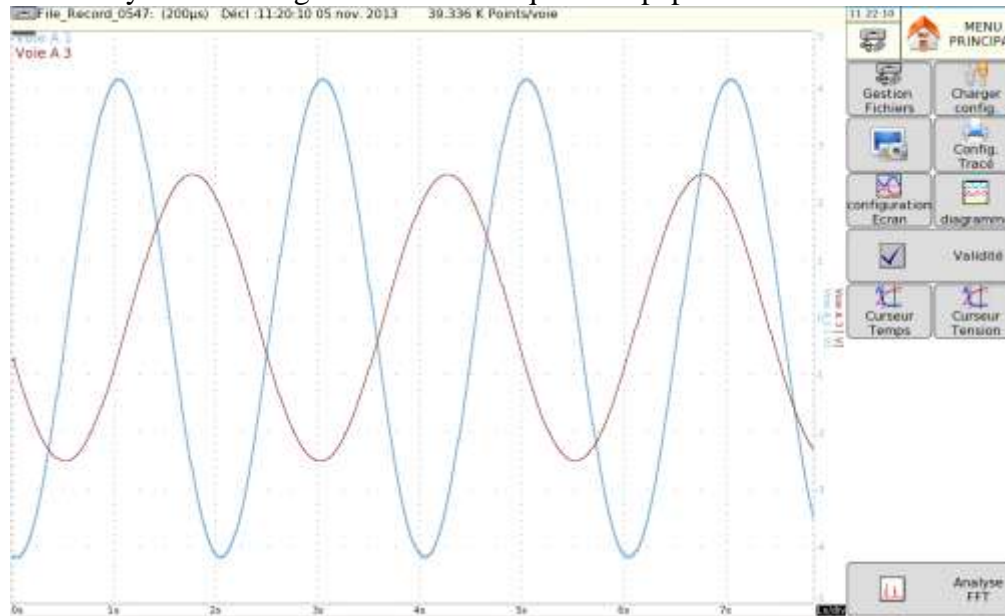

The following information appears on the left and on the top of the screen

- the number of displayed block
- the sampling speed of the block
- the date of the trigger
- the number of points per channel in this block

- **File management** : selection of the memory block or the file to observe, possibility of saving the acquisition
- **Loading setup** : load the setup linked with the observed file
- **Outline setup** : setup of the outline of acquisition, key “launch the drawing”
- **Screen setup** : setup of the display; see chapter **Use**
- **Diagram** : display of diagrams ; see chapter **Use**
- **Validity** : Validation of channels ON/OFF
- **Time cursor** : vertical cursors, zoom ; see chapter **Use**
- **Voltage cursor** : horizontal cursors ; see chapter **Use**
- **FFT analysis**: determine the response of signal frequency, see chapter **Use**

9. GO-NOGO MODE

This chapter describes the Caliber mode intended for recording the measures performed on channels in real time in internal memory.

The launching of acquisition can be trigger under various conditions. The stop occurs when the measures overpass a previous acquisition defined as CALIBER.

A simultaneous back up of measures on file can be enabled.

9.1. Set-up and triggering of the data acquisition

Press the “Triggering” key.

Definition of acquisition in internal memory on caliber.

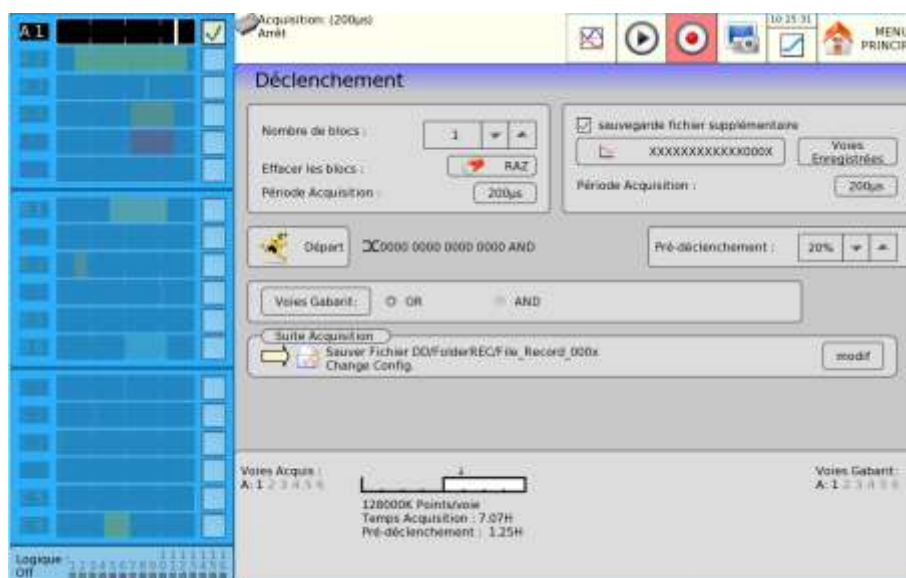

→ **Number of blocks** : parting of the internal memory into blocks

- 1, 2, 4, 8, 16, 32, 64 ou 128
- **Erase blocks** : deleting all blocks: the pending block is n°1

→ **Acquisition period** : sampling speed of the channels

- Regular in **intern** of **1µs à 10mn**
- Regular in **extern** by the logical channel 16
- **Additional file back up** : simultaneous recording of measures on file **Without** : no simultaneous back up
- **With** :
- **File name** : place and file name of the back up
- **Recorded channels** : shortcut of the key « **Validity** » to select channels to record.
- **Acquisition period** : sampling speed of channels

Start: starting condition of the acquisition

- Manual: by the key “Force the triggering”
- Triggering: on combination of analogical and logical channels, see chapter triggering
- Waiting: after a period or a precise date and hour
- Automatic: immediate; automatic stop when the block is full

Pre triggering: definition of the position of the starting trigger in the acquisition

- Acquisition pre triggering and post triggering (before or after the start), see chapter Memory Mode

Caliber channels: selection of the channels to compare with the caliber (by pressing on “caliber channels”; access to the definition of the caliber)



“Impossible” is displayed when the possibilities of back up are not possible anymore: reduce the sampling speed or the number of channels



See chapter File Mode to know the limits of the recording on a file.

Rest of acquisition: actions after the end of the acquisition

- Back up in a file: back up the acquisition in a file if the Real Time back up is not validated (or is impossible)
- Sending an email: this option will appear if you added a mail address before in “additional options” in the Setup. Menu;
- Drawing: drawing of the simultaneous acquisition in memory
- Stop: no action
- Rearmament: launch the drawing again; waiting for the starting condition again
- Change setup: loading of a configuration and waiting of the triggering

9.2. Creation of the caliber

Set the parameter “caliber channels” in the page “triggering” selecting a channel and a logical operator (AND or OR)

Do a normal acquisition or observe a file previously saved by the “memory output” function.

The appliance displays the current caliber, shown with 2 curves (one min, and one max) around the selected channel as reference for the caliber.

The 2 curves are saved in an internal file.

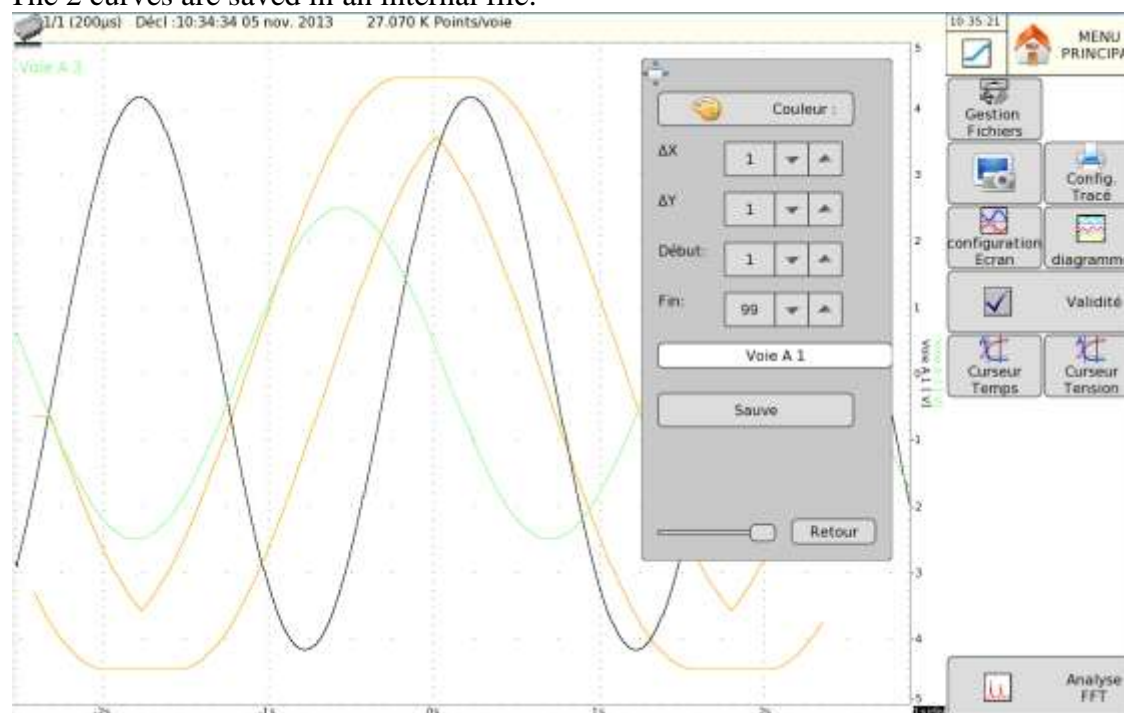

By pressing on « **file management** » and « **Modif. Caliber** », you will access to this page :

- ➔ **Color** : change the color of the caliber
- ➔ **DX** and **DY** : these keys allow you to build 2 min and max curves
- ➔ **Start** and **End**: limit of the memory depth where the stopping triggering test will be performed
- ➔ **Save** : when the caliber is correct, you can save it in the non volatile internal memory
- ➔ **Return** : return to the previous page, the caliber is no changed

9.3. Use of the caliber

The comparison with the caliber is used to stop the acquisition. This comparison will be performed on the “caliber channels” selected in the page “triggering”.

The information window at the bottom of the page “triggering” sums the general setup of acquisition:

- Channels and functions validated for the acquisition
- Channels and functions compared with the caliber
- The number of points per channels (function of the number of blocks)
- The total time of acquisition (function of acquisition speed)
- The position of the trigger (function of pre triggering)

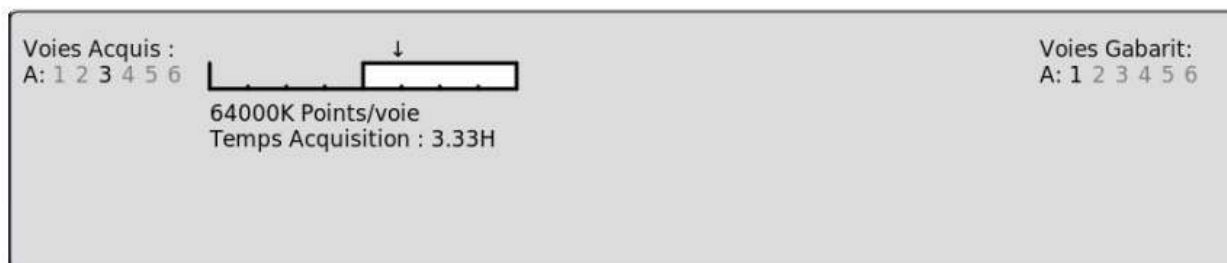

The acquisition is performed as previously (see chapter Memory mode).

When the memory block is full, the appliance checks that all points got on caliber channels are situated between the 2 min and max curves of reference that constitute the caliber.

If all points are inside the curves, the acquisition starts again (in the same block). Otherwise, the acquisition is stopped.

10. FILE MODE

This chapter describes the **File Mode** to record the calculations made on the channels in real time into a file. The start and stop of the plot can be triggered under various conditions.

10.1. Set-up and triggering of the data acquisition

Push the « **Trigger** » key.
Set-up of the data acquisition to a file.

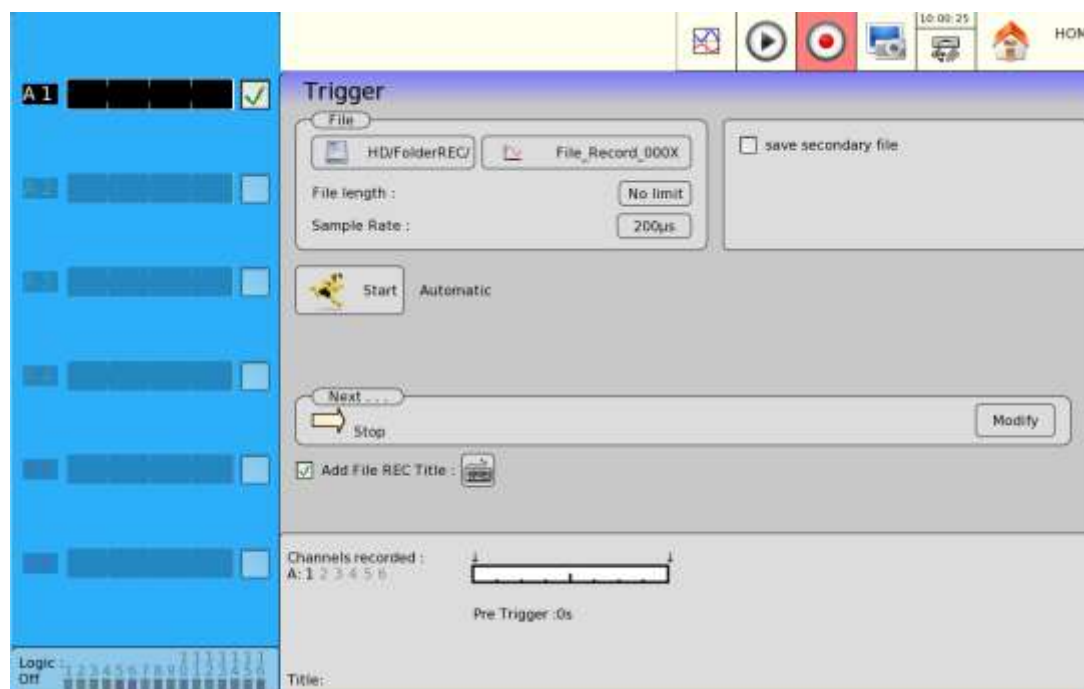
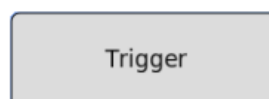

- **File name:** directory and name of the data acquisition file
 - directory of the data acquisition file
 - name of the data acquisition file
- **File length:** selection of the length of the file (unlimited...)
- **Sample Rate:** sampling rate of the channels
 - advancement paced **internally** from **1 μ s to 10 min**
 - advancement paced **externally** through the **logic channel 16**
- **Add a title to REC files:** Possibility to add a title to a file which will appear in the upper toolbar when the file is displayed.

- **Save secondary file:** simultaneous record of the measurement to a file

-
- **Without:** no simultaneous back-up
 - **With:**
 - **File name:** directory and name of the back-up file
 - **Record channels:** shortcut of the « **Validity** » button to select the channels to record
 - **Sample Rate:** sampling rate of the channels (5KHz max)
- **Start:** Start condition of the data acquisition
- **Manual:** with the F2 key « **Forcing Trigger** »
 - **Trigger:** on combination of analogical and logic channels ; See chapter **Triggers**
 - **Awaiting:** after a delay or at a specific date and hour
 - **Automatic:** immediate; automatic stop when the block is full
- **Stop:** stop condition of the data acquisition
- **Automatic:** when the block is full
 - **Trigger:** on combination of analogical and logic channels; see chapter « **Triggers** ». See chapter **Triggerings**.
 - **Double Trigger** start mode; see chapter **Memory Mode**.
- **Pre-trigger:** set-up of the position of the start of the data acquisition (300Kechant max)
- Pre-trigger of the acquisition (before start) ; See chapter « **Memory Mode** »
 - The trigger during the pre trigger can be inhibited.
- **Post- trigger:** set-up of the position of the start of the data acquisition
- Post-trigger of the acquisition (after start) ; See chapter « **Memory Mode** »
- **Next . . . :** actions after the end of the simultaneous data acquisition
- **Send Email:** this option shows up if you previously added an e-mail address in the « **Additional Options** » in the « **Setup** » menu
 - **Plot:** drawing the data acquisition
 - **Stop:** no action
 - **Rearm:** restarts the drawing; return to waiting the launching condition
 - **Change setup:** loading a configuration; return to waiting the launching condition
-

10.2. Annotation

During the data acquisition, you can annotate the file; a vertical line associated with a text will be integrated to the file when the user presses the F9 key (Annotation).

The maximum of annotation is 5000.

In case of power shortage, if the file has not been correctly closed, the annotations will be lost.

The SeframViewer software makes it possible to display these annotations onto a PC.

10.3. Compare files and reference

10.3.1. Reference file

You can compare files between them or having a viewing reference in recording mode file (not available in XY mode).

Choose the reference file in the OUTPUT page:

In Blocks/ reference select a file:

- Binary 'rec'
- Text file 'txt' or '.csv'

10.3.2. Texte File

The user can create itself a text file (from a text file or csv copy from binary file for example) (not available in XY mode).

You can edit the file on a PC editor or in Excel (csv file) and copy the files by FTP to the recorder or with USB key (the file will be copied in the root of the hard disk.

File format:

- N line (maximum 10000 lines).
- A line does not start with a numeric value is considered a comment line.
- each line is compose by:

```

/refTexteok.txt
1 // reference test
2 // 2 channels A1 et A2
3 //
4 Date A1 A2
5 0 2 -0.5 // first point
6 10 2 -0.5
7 40 -1.5 1 0.5
8 100 -1.5 1
9
10

```

- A numerical value dating (second value) (separator '.' or ',')
- N digital channels values (separated by blank characters, tab or character ';') corresponding to the channels A1,A2 etc...
- Values are numerics type (separator Les valeurs sont de type numériques (separator '.' or ',')
- Examples : 0 -1,0 12.23 8.7 E -3 -388.7E +3

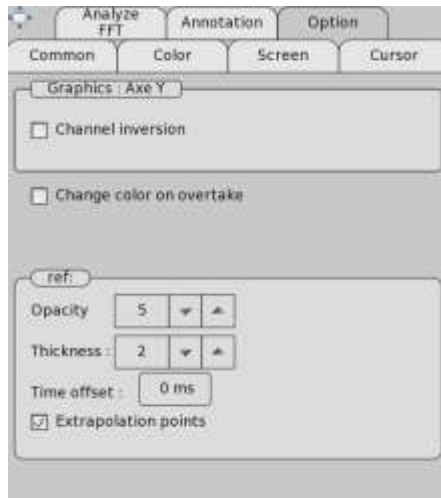

In the windows Setup/option you can choose

- Opacity of each channels
- thicknes
- Time offset (in milliseconds)
- Extrapolations of points.

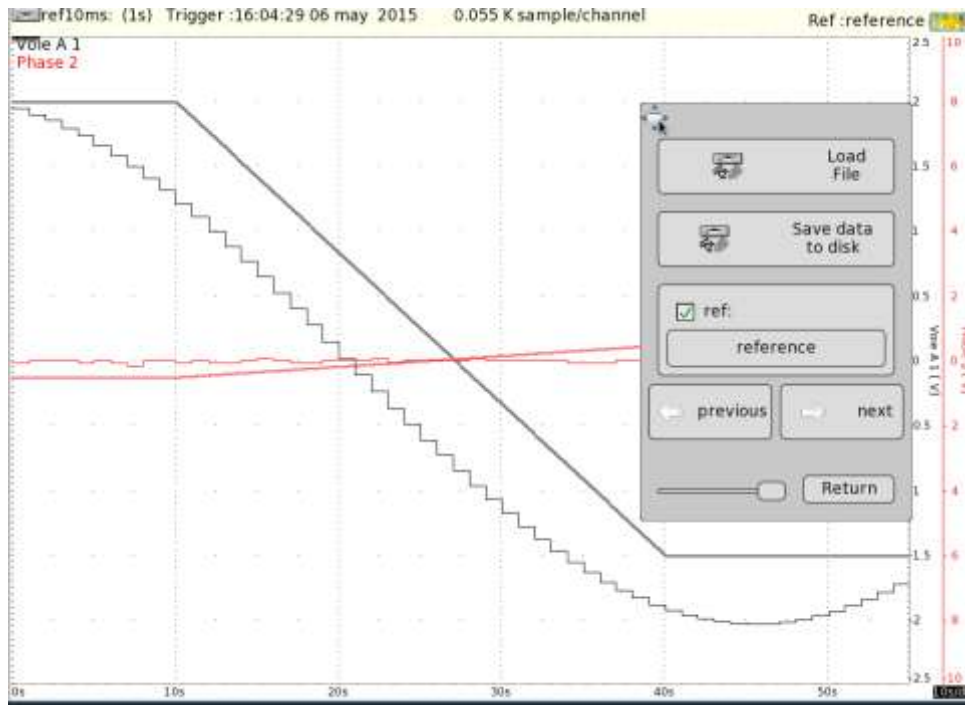

10.3.3. Compare with wall paper

You can add a wall paper (png file) (key Setup Screen >Color)

You can use a paint software (paint paint.net , gimp ...) for create/modify the wall paper copy the file with ftp or Usb key (the will will be copied in the folder FolderGraticule

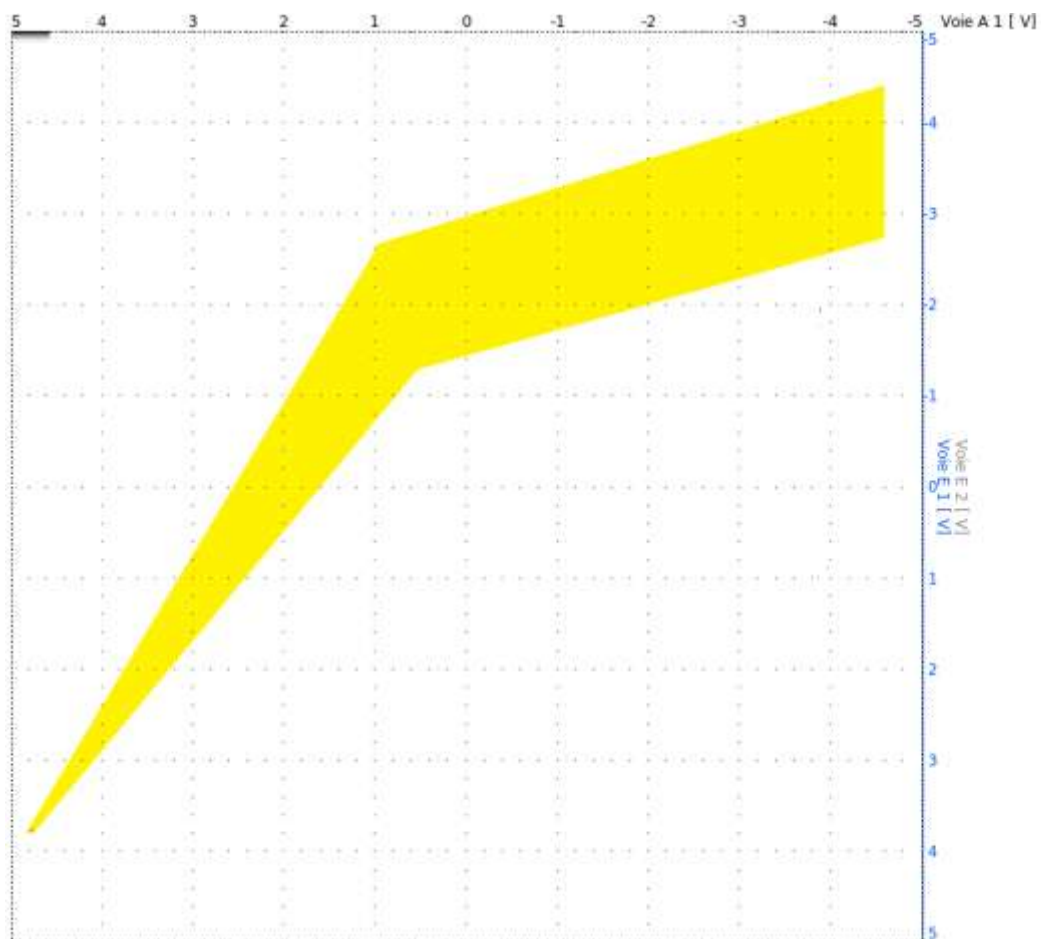

10.4. Limitation

The real time data acquisition onto a file is limited by the transfer rate between the inputs and by the hard drive write speed.

The maximum transfer rate onto a hard drive is 6 Msample/s.

To know the number of channels that you can record at a given acquisition period, follow the following formula:

$$\text{*number of channels} = 6\,000\,000 \times \text{acquisition period}$$

Example: acquisition period: 10 μ s
Number of channels = 6 000 000 x 10 μ s = max. 60 channels



« **Impossible** » shows up when all possibilities of back-up are exceeded: reduce the sample rate or the number of channels

After the record it's possible to create a text file (choose the format in the page Setup) (save file)

On a PC it's possible to download the binary file with FTP and convert this file directly in text, csv or excel file with sefram pilot

Example: the command "c:/program/seframviewer myfile.rec /t" convert directly myfile.rec in myfime.txt

11. POWER ANALYSER

11.1. GENERAL

The circuit analysis option makes you possible to measure powers and harmonics. The measured values can be displayed in real time or recorded. The channels that are not used for the measurements of power or energy values keep on working normally. For example, in case of three-phase current, you may have interest to record the neutral current on other channels. It is also possible to record logic channels.



THIS FUNCTION IS NOT POSSIBLE FOR APPLIANCES THAT DO NOT INCLUDE AN ISOLATED 6-CHANNEL INPUT CARD

Launching the circuit analyzer includes:

- Start: Press the « **POWER ANALYSIS** » key
- Description of the circuit and cables: « **Setup Analyzer** » menu
- Selection of the selected type of analysis and value: « **Trigger** » menu
- Display (Oscilloscope, Numeric, Harmonics) : « **Visualization real time** » menu
- Data acquisition: « **Start/Stop** » key



Attention:

The connection of the inputs on the installation to test should be made by an authorized personal. Connect the earth pole before connecting the live lines.

11.2. Installation: "Set-up Analyzer" Menu

In the main menu, by pressing the « **POWER ANALYSIS** » key, you directly access the configuration page of the channels. You can also access this page through the « **Setup Analyzer** » key.



In this page, you select the type of circuit and the parameters of the inputs.

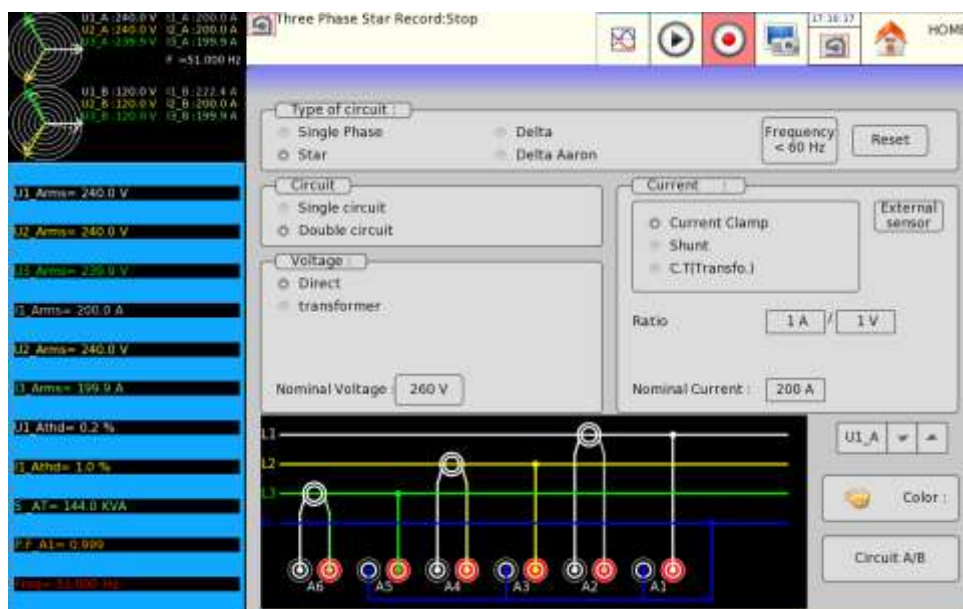

→ Type of circuit:

- selection of the basis set-up of the circuit (**Single-phase**, three-phase (**Star / Delta / Delta Aaron**)).
- Selection of the **frequency** (< 60 Hz / < 500 Hz / < 1000 Hz)
- Number of circuit (4 max) (for multiple circuit you must have cards 500V or 1000V), for 3 or 4 circuits only frequency 50/60Hz are available.
- **Reset**: to set up the channels in a basis configuration and parameters

→ Voltage:

- « **Direct** » or « **Transformer** ». Select this set-up if the circuit voltage is submitted to a transformer. You have to type the transformation ratio.
- **Nominal Voltage**: The appliance automatically selects the right caliber. You only have to specify the nominal voltage of the circuit. Attention: if this value is too far from the true voltage value, it may induce excessive or inaccurate caliber values.

→ **Current**: The same is worth as for the voltage; you select the type of current input (clamp, transformer, shunt). In each configuration, you must select the associated parameters:

- for « **Current clamp** »: Primary current, Secondary voltage (these are intensity/voltage clamps)
- for « **C.T. (Transfo.)** » (transformer + shunt): Primary and secondary currents and value of the shunt
- for « **Shunt** »: value of the shunt, in Ohms
- the **nominal current** is also defined like the nominal voltage

- Possibility to assign an **external sensor** to the selected channels.
- The data acquisitions are synchronized with the calculation of the frequency on channel 1.
- In three-phase mode Aaron, the circuit is symmetrical: you can only have 2 used intensity inputs; hence, the third one will need to be calculated.

Cables and check:

The cables of the circuit are directly displayed. Any mistake with the cables may lead to false measurement values.

The color of the channels matches the color of each input.

You can see that the U1, U2 and U3 voltages are linked with the odd inputs A1, A3 and A5. The I1, I2 and I3 intensities are linked with the even inputs A2, A4 and A6.

For example, in Aaron Triangle mode, the free channels will be A5 and A6

Fresnel diagram:

You can check the accuracy of the cable assembly by displaying the Fresnel diagram. The length of the vectors is not proportional to the effective value of the intensities: the user needs to check the consistency of what is specified.

The position of the voltage vectors is calculated with reference to the V1 voltage.

Attention: The angles are of the significant voltages/intensities either for the shape factor (P.F) or of the fundamental values.

Hence, you can know whether the connection is direct or reverse. The intensity vectors are calculated with reference to the corresponding voltages.



Attention: Mistakes may have been done even if nothing weird appears. In any case, the cable mounting must be achieved with caution by a qualified personal.

Warning messages:

These messages lay appear in red at any moment on top of the screen:

- Impossible to synchronize the signal: the frequency is wrong, the signal is too weak or too noisy.
- Caliber overrun: The voltage or the intensity is too high for the specified nominal value; you have to change the value or use another probe.

11.3. Display of the signal:

By pressing the Direct Display key, you get access to the following parameter windows.

You can access this page even during data acquisition.

Each of these windows can be deactivated.

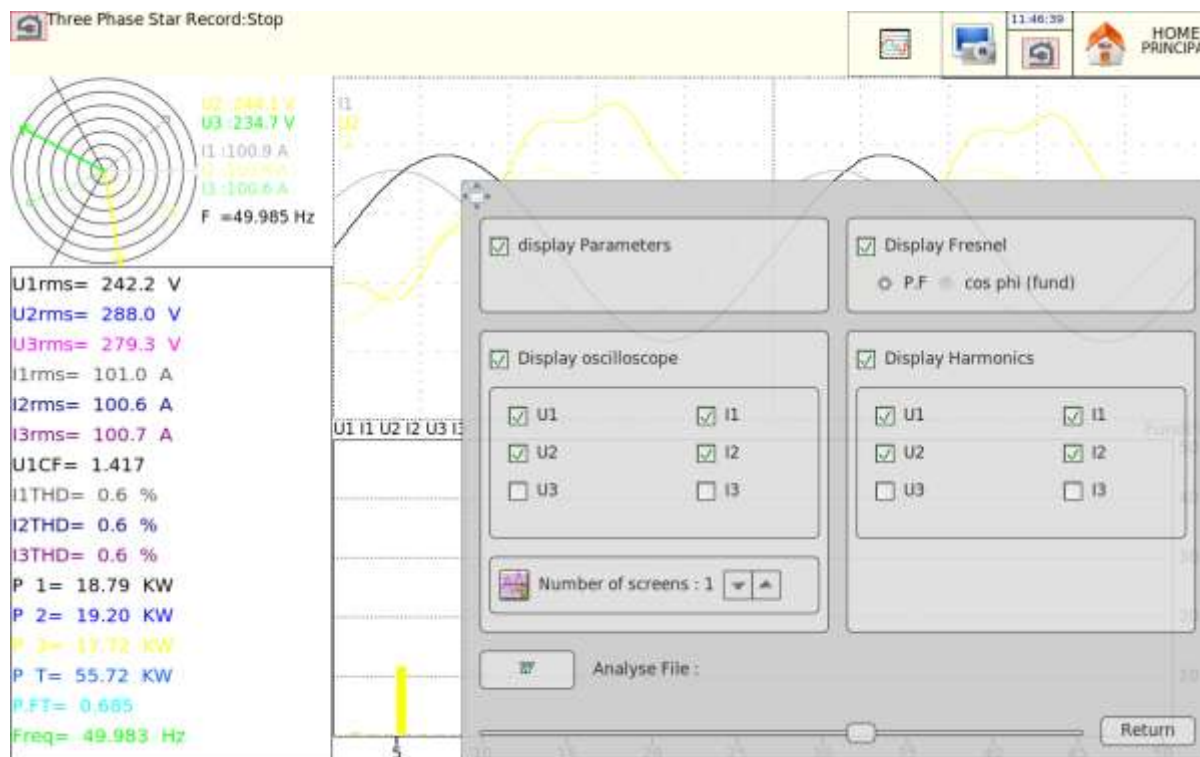

→ **Display Fresnel:** display of the signal and the RMS values and frequency for the inputs (see the previous paragraph)

→ **Display Parameters:** display of the values of each defined parameter (see the following paragraph)

→ **Display Harmonics:** This window is updated ca. 4 times per second.

Selection of the channels: you can select either all voltage channels (U1,U2,U3), all current channels (I1,I2,I3), all circuit channels (U1,U2,U3+I1,I2,I3) or only one channel (these channels are also used to record harmonics (see paragraph 11.4.2))

→ **Display Oscilloscope:** The oscilloscope mode makes it possible to recognize the exact shape of the signals and helps find cable mounting errors.

- The time base depends on the frequency of the signal (at least one rotation)
- You can add additional channels and new screens
- The used calibers are indicative and do not reflect the true values of the inputs (the min. and max. positions match the maximum authorized values)

→ **Analyze file:** You can open a new text file (**RT_Analyse.txt**) that contains the data of the parameters and instant harmonics.

- **Record a new value:** to record a value at the very moment when you press the key
- **Open a new file:** pressing the INIT key updates the page and clears every previous values
- **Read file:** displays all recorded values.

You can copy the screen any time into a bmp file.

11.4. Trigger Menu

When the appliance is set up, you have to select the type of measurement to make: power analysis or energy analysis. You select the parameters by pressing directly the channel you want on the left of the screen.



11.4.1. Parameter acquisition file

You first have to set up the acquisition period, the length and the name of the file and the directory of use.

Contrarily to the file mode, there is no trigger: as soon as the recording is started, the parameter values are recorded; the data acquisition will stop when pressing the « Acquisition Stop » key.

11.4.2. Acquisition file of the harmonics

At the same time, you can record harmonics of the signals in text mode. You select the acquisition period of the harmonics (from 1 second to 1 hour). The recorded channels are the same as specified in the « Display » page (chapter 11.3). The file that you create has the same name as the parameter file, but with the .txt extension. A text editor or Excel will be able to read it (but not SeframViewer).

11.4.3. Recordable parameters

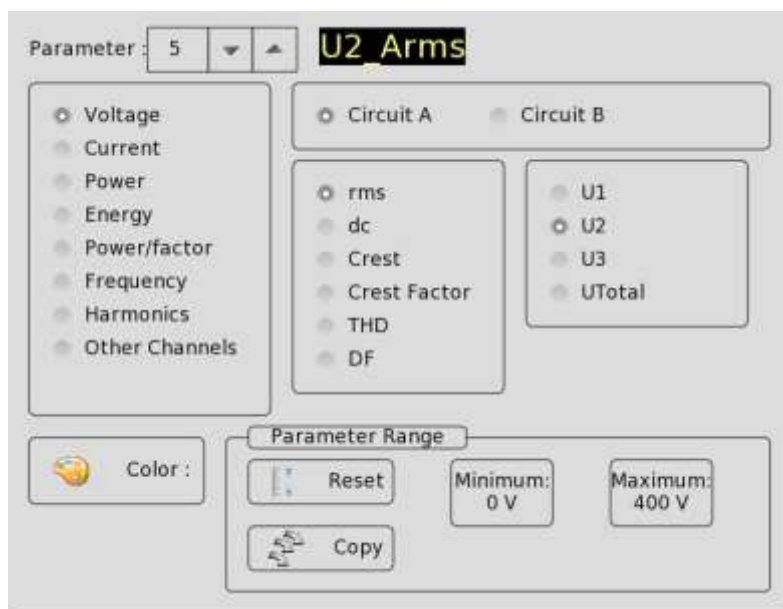

→ **Number of parameters:** the possible values are 1 to 61.

→ **Validity parameter:** to select the validated channels.

→ **Parameter:** To select the channel to parameter. You can choose:

- Voltage and Current:
 - **rms:** RMS
 - **dc:** average value (DC offset)
 - **Crest:** maximum value between the max. and min. peak values
 - **Crest Factor:** ratio between the crest value and the RMS (1.414 for a sinusoid signal)
 - Harmonic distortion rate **THD:** specifies the total presence of harmonics as a ratio to the fundamental component of the signal
 - Distortion factor **DF:** DF% specifies the total presence of harmonics as a ration to the true efficient value of signal.

- Power:
 - **P:** Active
 - **Q:** Reactive
 - **S:** Apparent
- **Energy:** cumulative value; initialization at page « Display »
- **Power/factor**
- **Frequency:** the calculation of frequency is made on the input U1
- **Harmonics:** selection of the channels, whose harmonics you want to display
- **Other channels:** to select another input channel.
- Logic channel: only the last parameter can be set up this way.

In voltage and intensity mode, you can select each line (example U1, I2) or the global value of the circuit (Ut, It)

For each parameter, you can change the following values:

- **Color:** color of the displayed parameter on a graph. For additional and logic channels, the colors are as defined for each of those channels.
- **Caliber:** the caliber is defined with the nominal values of voltages and intensities. For example, for a nominal voltage of 230 V, the caliber shall be 400 V centered around 200 V (hence, 0 to 400 V). You can change the minimum and maximum for better accuracy. For example, you can display the signal U1 between 220 V and 240 V

11.5. Record

You launch the data acquisition by pressing the « **Record** » key. It is paced at the rate of the integration period. You can also record the parameters into a file (real time save on a hard disk).

Unlike the normal record mode, there is only one block and the complete data acquisition is displayed in real time.

During the data acquisition, you cannot change the data acquisition parameters, but you can change the display parameters (zoom, color, validity of display, etc.).

You can also display the signals under scope mode or display the parameters under numeric mode.

To stop the data acquisition, press « **Stop Acquisition** ».

In case of power shortage during the data acquisition, the registered file is correctly closed. At re-energizing, any new data acquisition will be made with possible opening of a new file.

11.6. Measurement method

Root Mean Square:
$$X_{rms} = \sqrt{\frac{\sum_{k=1}^N x_k^2}{N}}$$

Average value:
$$X_{mean} = \frac{1}{N} \sum_{k=1}^N x_k$$

Active Power:
$$P = \frac{1}{N} \sum_{k=1}^N v_k * i_k$$

Apparent Power:
$$S = U * I$$

Reactive Power:
$$Q = \sqrt{S^2 - P^2}$$

Power Factor:
$$FP = \frac{P}{S}$$

Crest Factor:
$$FC = \frac{X_{crest}}{X_{rms}}$$

Distortion Rate:
$$THD = \sqrt{\frac{X_i^2 - X_{fond}^2}{X_{fond}^2}}$$

Distortion Factor:
$$DF = \sqrt{\frac{X_i^2 - X_{fond}^2}{X_i^2}}$$

Total Active Power:
$$P_T = P_1 + P_2 + P_3$$

Total Reactive Power:
$$Q_T = Q_1 + Q_2 + Q_3$$

Total Apparent Power:
$$S_T = \sqrt{P_T^2 + Q_T^2}$$

Total voltage:
$$U_T = \sqrt{\frac{U_1^2 + U_2^2 + U_3^2}{3}}$$

Total Intensity:
$$I_T = I_1 + I_2 + I_3$$

Total Power Factor
$$FP_T = \frac{P_t}{S_t}$$

Energy: the cumulative value of power P; you can clear this value in the Display page

Attention: the maximum value of the energy in acquisition mode is limited to

$E = P_n * H$

P_n = nominal power

H = 12 hours

12. FILE MANAGEMENT

12.1. General

For all possible files, the appliance has an internal hard disk and can receive an USB stick that makes it possible to:

- save or reload the total set-up of the recorder
- save or display a data acquisition.

The set-up files have a *.CNF extension.

The data acquisition files have a *.REC extension.

You can create directories and save files into them. To do so, press the « **Set-up** » key in File mode, then select « **Save on Disk** ».

Press « **Add Folder** » when suggested.

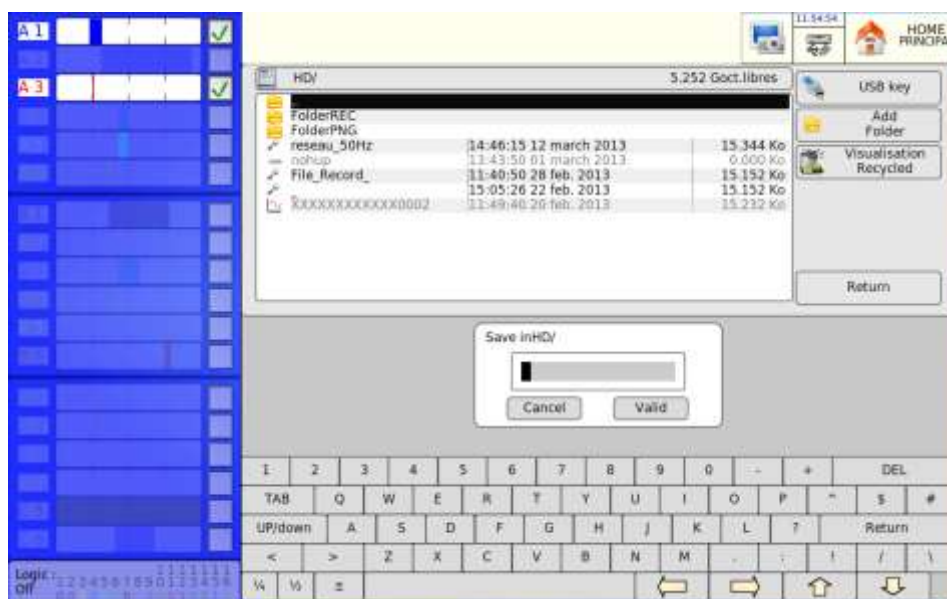

- **USB key**: read / write to an USB stick (if connected at the start-up of the appliance)
- **Add Folder**: creation of a directory; you can type its name with an alphanumeric keyboard on screen.
- **Visualisation Recycled**: gives access to deleted files in case of recovery.



It is very advisable to work under a directory and not at the root of the hard disk.
When you delete a directory, all files within are deleted.

12.2. Managing the set-up files

The page to manage the set-up files is linked to the "**Set-up**" key.
Their name has a *.CNF extension.

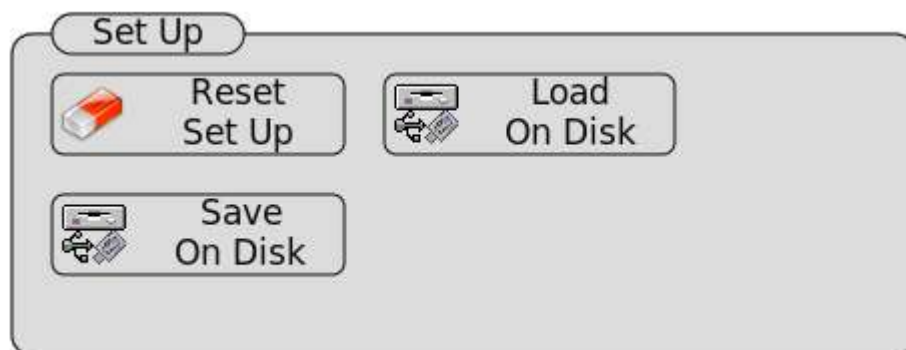

- **Reset Set up**: initialization of the appliance under a standard set-up
- **Save on Disk**: back-up of a set-up to a file on the internal hard disk or an USB stick
- **Load on Disk**: loading a set-up from a file on the internal hard disk or an USB stick

12.2.1. Saving set-up files

Press the « **Save on Disk** » key.

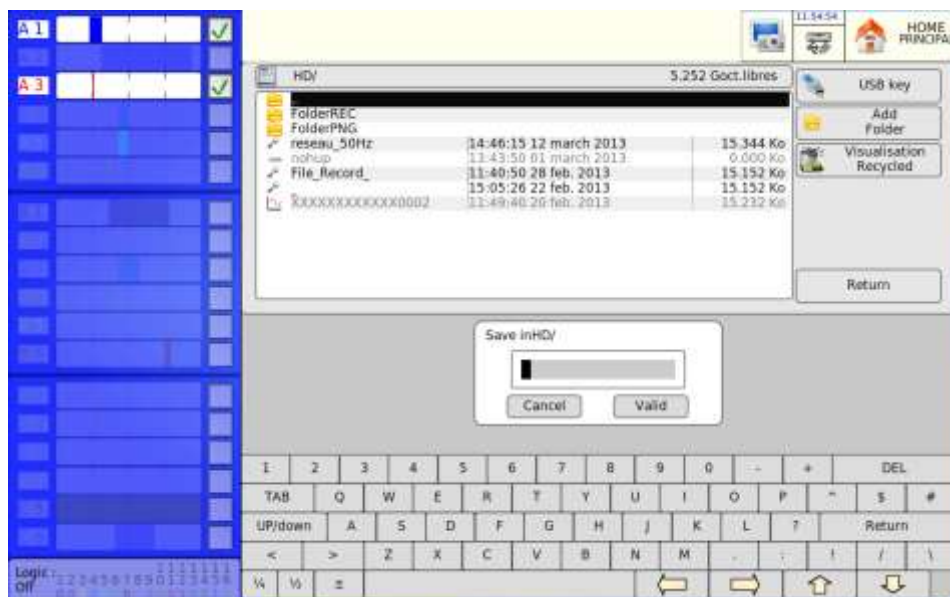

You can type the name of the file with an alphanumeric keyboard on screen, or with an external PC-type keyboard if connected.

12.2.2. Loading set-up files

Press the « **Load on Disk** » key.

Select the directory, then the file to load, and click « **Load** ».



Attention: You will lose the current set-up.

12.3. Managing the data acquisition files

12.3.1. Saving acquisition files

To save the data acquisition, you must define the parameters of the triggers.

There are 2 ways to save data acquisitions into the appliance:

- by recording data acquisitions into internal memory through the blocks in memory mode and template mode (see the chapters Memory mode and Template mode)
- by recording the data acquisitions on a disk (see File mode).

The « save additional file » function makes it possible to record all the data acquisition (all blocks at a time).

At the save file stage using «**Files manager**» → «**Save data to disk**» two file formats are possible:

Once the acquisition completed, the files can be saved in two different formats :

- **Binary file:** These files can be opened by the device, SeframViewer and Flexpro. It contains all the data and configurations.
- **Fichier text:** Only save the physical channels (not the mathematical channels) and cannot be open by the device. Its purpose is to be used with Excel.

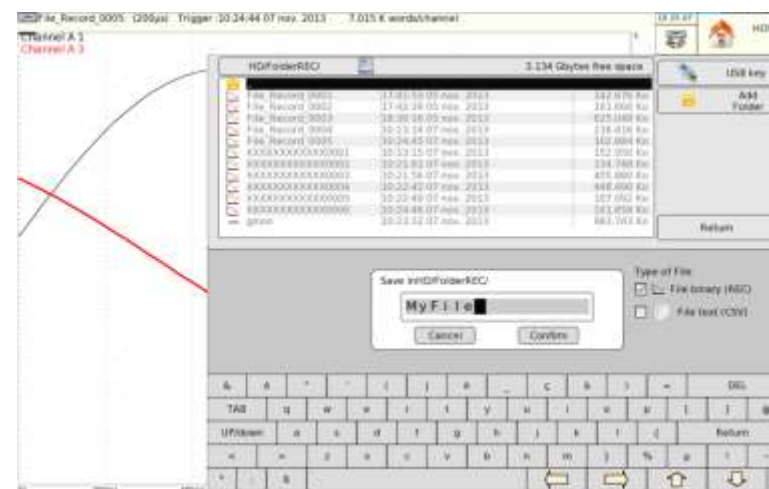

12.3.2. Loading acquisition files

Press « **Replay** » then « **Files manager** ». Press once again on « **Load file** », and then select the file you want to load.

Select the directory and the name of the file to load to display it on screen.

You can load the set-up of the channels (type, name, functions etc....) and their validations: to do so, validate « **Load Set-up** »

12.4. Recycle bin

When you erase a file, it is saved in a hidden directory.

The content of the recycle bin is limited to a little more than 5 Go. In case of overrun, the oldest files are definitively erased.

To display this recycle bin, you only have to open the Directory page and press « **Visualization Recycled** »: the files show up in blue. You will be able to open the files, save them to an external stick or a FTP Link or read/erase them.

You can also empty the bin.

13. PRINTING

This chapter describes the direct printing of the results on a local printer or a connected one (LAN or WIFI).

You start the printing with the « **Print** » key from the following functions:

- « **F(t)** » and « **XY** », « **Set-up Plot** » key (stopped scan)
- « **Replay** » and « **Start/Stop** », « **Set-up Plot** » key

You can create a file copying the display on screen:

- Screen Print key of a PC keyboard
- Screen Print key of the recorder



The file will be created either on the USB stick, if present, or on the hard disk.

The name of the file will be bmpxxxxx.bmp (incremental name)

On the hard disk, the files will be saved into the FolderBMP directory.

You will be able either to copy this directory on an USB stick or to delete it. You will also be able to use an ftp link to recover these files or delete them.

13.1. Set-up and start of the plot

Press the « **Set-up Plot** » key from the « **F(t)** », « **XY** », « **Start/Stop** » or « **Replay** » functions.

Under « **XY** » or « **F(t)** », the scan must be stopped (« Freeze screen » key) to access to this key.

Under « **Replay** » or « **Start/Stop**», a memory block or a file must be displayed on screen to access to this key.

For the 8460, there are 2 possibilities:

- Internal printer: the internal printer of the recorder is selected, you just have to choose the length of the paper
- External printer: the printing will be performed on an external printer

You have to set up a few parameters to use an external printer:

- **Printer Set-up:** selection of the type of printer in a list; see the following chapter.
- **Margin:** width of the margin in millimeters (depends on the selected printer)
- **Launch plot:** starts the printing

13.2. Selection of the printer

The « **Set-up Printer** » key launches printer selection software in the list of existing printers.

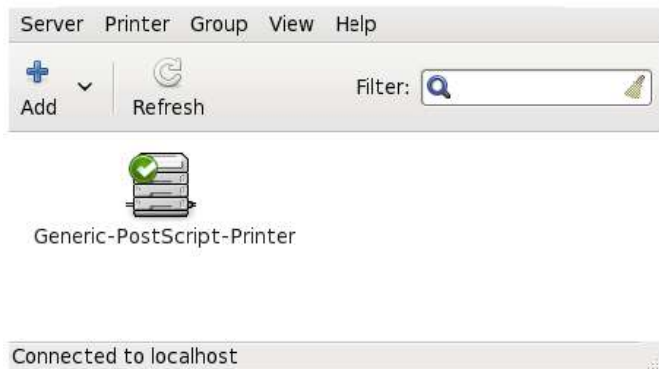

Click the « Add » button to find the local printer.

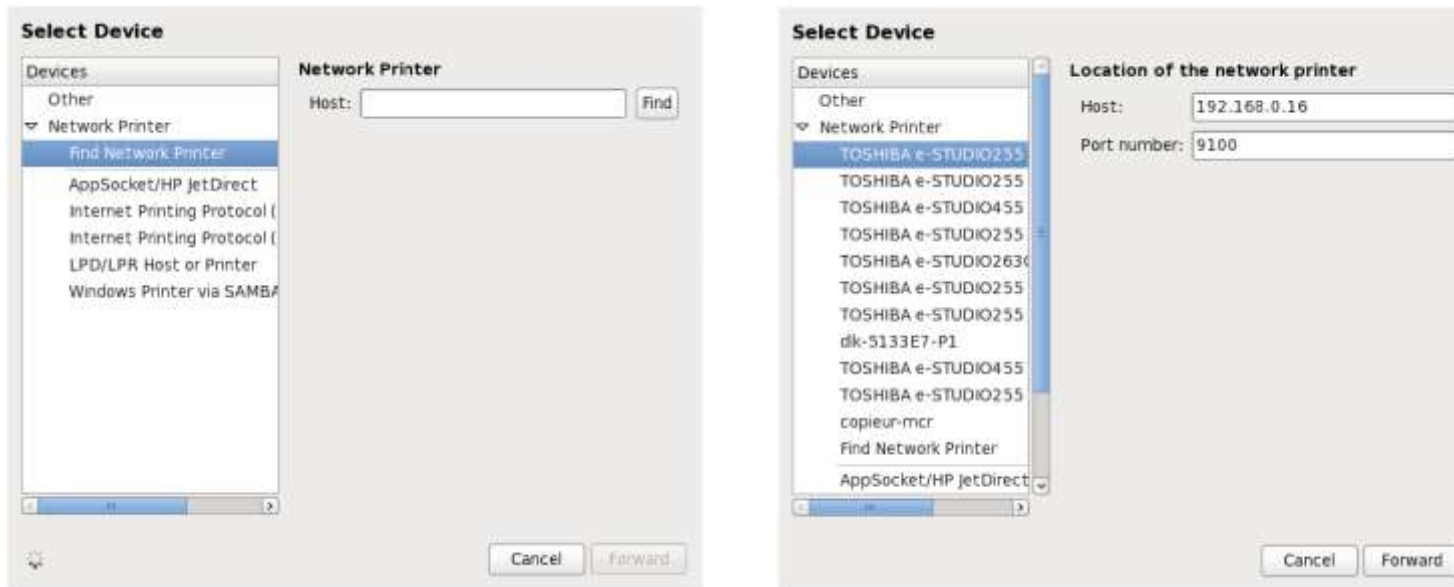

Click a small arrow on the left of « **Network Printer** ». The software will look for the printers connected to the network.

Select the manufacturer and the model of the printer, and then click on « Forward ».

The software will search the drivers. You will have to select the right driver.

If the software does not find the right drivers for a PostScript driver, you'd better find drivers as close as possible from the local printer: If your printer does not appear in the selection list, you can try any similar printer by the same manufacturer – its driver will probably be the same.

You can check the driver used with your printer on the website: http://openprinting.org/printer_list.cgi

Example:

For the TOSHIBA e-STUDIO255 printer, you can use the driver of the TOSHIBA e-STUDIO205 printer.

13.3. Printer for USB connection

You can connect the recorder to a printer with a USB connector.

In this case, the connected printer will show up directly on screen:



 In case of problem by the set-up of a new printer, you can reboot the basis printer in the « Set-up » page

14. INPUT / OUTPUT

14.1. Additional Input / Output Connector

The connector is at the rear (SUB-D 25 male pins).

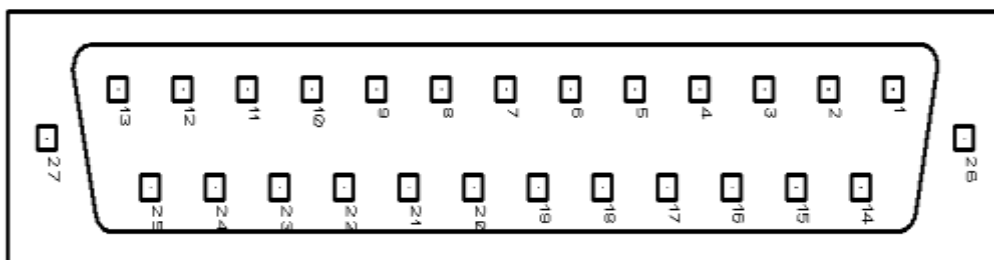

The ground of the power supply is the mechanical earth of the casing of the SUB-D25

Pin no	I/O	Nom des signaux
13	I	Logic channel 1
25	I	Logic channel 2
12	I	Logic channel 3
24	I	Logic channel 4
11	I	Logic channel 5
23	I	Logic channel 6
10	I	Logic channel 7
22	I	Logic channel 8
9	I	Logic channel 9
21	I	Logic channel 10
8	I	Logic channel 11
20	I	Logic channel 12
7	I	Logic channel 13
19	I	Logic channel 14
6	I	Logic channel 15
18	I	Logic channel 16
5		Ground
17		Ground
4		Ground
16	O	Power 9-15V 0.2A
3		Ground
15		Alarm A
2		Alarm A
14	O	Alarm B
1	O	Alarm C

14.2. Logical inputs

The non-connected inputs have the following circuit:

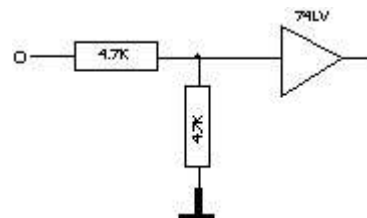

The non-connected inputs are 0 V potential (level 0).

Number of logic channels: from 1 to 16.

TTL level: 3.3 V (protected until 24 V)

To create a rising edge, you only have to create a connection between the power supply 12 V input and the output of the connector.

Similarly, to create a falling edge, you only have to remove this connection.

You can also use a TTL 3.3 V output signal.

14.2.1. Use

Plot and display:

These channels are plotted on the left or the right side of the paper according to the selected format.

They are displayed at the top or the bottom of the screen according to the selected position.

They are numbered from the right to the left.

Each channel is plotted between two dotted lines that specify the limits.

The height of the reticules is min. 2mm for the plot.

External clock:

You can use the channel #16 (pin #18 on the connector) to synchronize the channels in all modes (Memory, Go/Nogo and File).

The max. speed of the paper is ca. 10 mm/s.

In « Text » writing of the measurements, the paper scroll is made the same way. In this case, the transcription frequency is restricted to 1 Hz.

In other modes, the data acquisition is up to 500 KHz.

Triggers:

You can use the external channels to trigger the plot and the data acquisitions (start or stop) (Mode AND or OR).
See chapter « **Triggers** ».

14.3. Alarm outputs

Contacts and outputs available at the rear connector (A1 / A2), B and C.

The A1/A2 contact is a « off voltage contact » with no potential (24 V /200 mA).

The B and C outputs are TTL 5 V.

When the appliance is off voltage, the contact A1/A2 is open and the B and C outputs have a 5 k Ω impedance.

14.3.1. Use

Signalizing internal events toward the outer environment to the recorder (triggers on analogical or logic channels, states of the printing block...)
See chapter « **Use** », paragraph « « **Set-up** » key ».

14.4. Power supply output

There is a power supply output +12 V limited to 0.2 A on the pin #16 of the connector.

The grounding of the power supply is the mechanical earth.

You can also use this output to supply energy to a sensor or an electric circuit to manage the logic inputs.



The 12 V may disappear in case of intensity overload (> 0.2 A). In such a case,
You have to turn off the appliance a few minutes before switching it on again.

14.5. Extension box for input/output interface

The extension box makes it possible to detect a voltage and convert it into a logic signal for all 16 logic channels.

The inputs are isolated between each other and from the ground.

The « green » terminal block of each channel is isolated from the red and black bushes of the same channel.

The 10-pin terminal block (non-isolated) makes it possible to supply energy under 3.3 V, 5 V or 12 V to an external circuit and to connect alarm outputs.

Use:

Connect the 25-wire cable between the I/O connector of the recorder and the box (4 on figure 1).

Connect the signals according to the case:

90 V to 250 V AC or DC, red and black bushes (1 on figure 1)

10 V to 48 V AC or DC, pins #1 and #3 of the « green » terminal block (2 on figure 1)

< 10 V AC or DC, between pins #1 and #2 of the « green » terminal block (3 on figure 1)

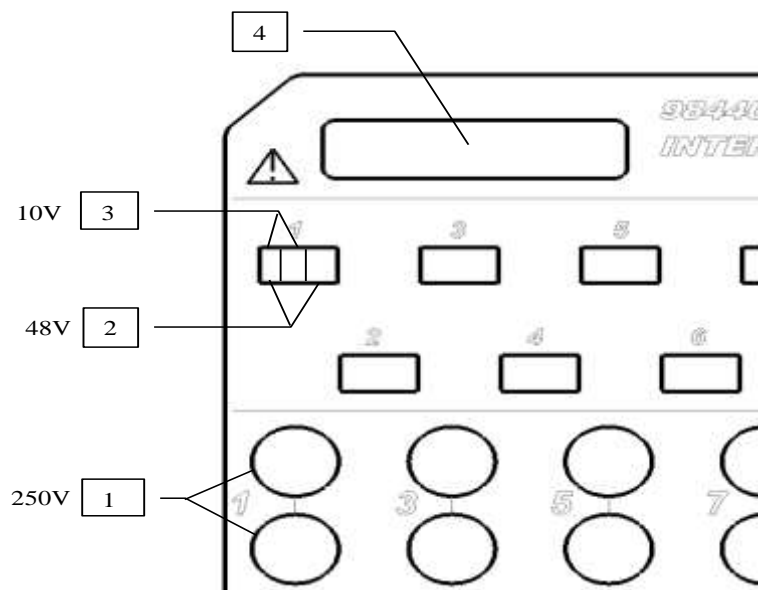

Fig 1

The extension box for input/output interface option (code 984405500) makes it possible to:

- convert an alternative voltage (example: 230 V 50 Hz) into a logic signal 1
- easily connect inputs from the 16 logic channels
- isolate the 16 logic inputs (250 V= \sim between channels, 250 V= \sim between channels and ground)
- easily connect alarm outputs with a screw terminal
- supply energy to an external accessory with 3.3 V, 5 V or 12 V with a screw terminal

Connection of the logic channels according to the signal voltage:

- 0 to 250 V = \sim

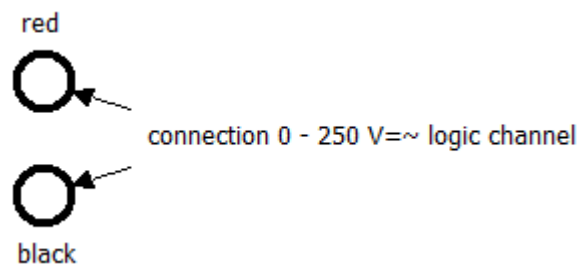

Through a banana plug isolated between the red and black bushes
 Max. voltage available: 250 V AC or DC
 Typical trip threshold (AC or DC): 48 V
 Frequency: 45 to 440 Hz
 Non-detected low threshold (AC or DC): 0 to 10 V
 Detected high threshold (AC or DC): 60 V to 250 V
 Isolation: 250 V= \sim between channel and ground

- 0 to 48 V = \sim

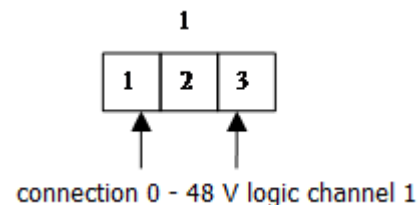

Through pole and screw between the dots #1 and #3 of the screw terminal
 Max. voltage available: 48 V AC or DC
 Frequency: 45 to 440 Hz
 Typical trip threshold (AC or DC): 9 V
 Non-detected low threshold (AC or DC): 0 to 2 V
 Detected high threshold (AC or DC): 10 V to 48 V
 Isolation: 50 V= \sim between channel and ground

- 0 to 10 V= \sim

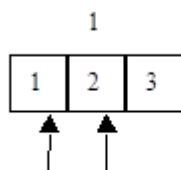

connection 0 - 10 V logic channel 1

Through screw terminal between the dots #1 and #2 of the screw terminal

Max. voltage available: 10 V AC or DC

Frequency: 45 to 440 Hz

Typical trip threshold (AC or DC): 2.2 V

Non-detected low threshold (AC or DC): 0 to 1 V

Detected high threshold (AC or DC): 3 V to 10 V

Isolation: 50 V= \sim between channel and ground

Response time:

To detect the alternative signal, the signal of the logic channels is rectified and filtered

Typical delay for a rising edge: 10 ms

Typical delay for a falling edge: 50 ms

14.5.1. Use

Link the box to the input/output connector of the appliance with the 25-pin connector provided with the option.

Connect the logic channels to record with respect to the max. authorized voltages

Power supplies / Alarms:

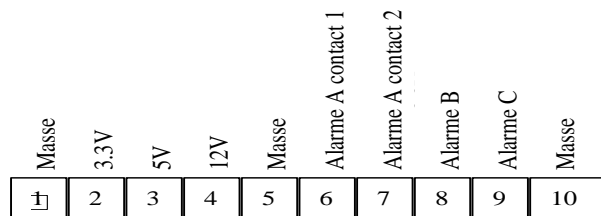

max. current 3.3 V: 200 mA

max. current 5 V: 200 mA

max. current 12 V: 200 mA

Alarm A contact 1 and 2: open in case of alarm, isolation 50 V_{max} / ground

Alarme B: logic output 0 V / 5 V non-isolated

Alarme C: logic output 0 V / 5 V non-isolated

15. INTERFACE

15.1. Ethernet interface

15.1.1. General

You can remotely use the recorder with its Ethernet interface through the TCP-IP protocol.
Plug the recorder onto your network with a straight cable on the 10/100 BASE-T connector (RJ45) at the rear of the appliance.

You can use the recorder with a 10 Mbit/s or 100Mbit/s Ethernet network.

If your network includes a BNC cable, you need an external hub to convert the BNC signal into RJ45 signal (use a straight cable).

If your PC has no network, you can also use a crossover cable directly between the PC and the recorder.

Crossover cable

Connector 1		Connector 2	
Broche	Signal	Broche	Signal
1	TX+	3	RX+
2	TX-	6	RX-
3	RX+	1	TX+
6	RX-	2	TX-

The recorder uses the TCP/IP protocol to dialog with the PC. You can then give it an IP address with a subnet mask.
Ask your network administrator for an IP address with the corresponding subnet mask. Type the values, then turn off and on the appliance to validate the new address.

If you have no network administrator:

Check that the TCP/IP driver is installed on your machine.

For a PC under Win 95 or Win 98:

From the Windows browser, go to "Workstation" then "Configuration panel" then "Network".

Check that the TCP/IP protocol is installed, and then check the IP address and the subnet mask.

You must take care to define an IP address and a subnet mask compatible with the remote computer.

The port used by the recorder is **Port #23**.

Case with DHCP: if you use a DHCP server, it will automatically assign an address to the recorder; you can read this address in the « Set-up » page.

Case with manual IP:

For example, in I mode, you can have:

PC	IP=192.135.20.00	mask = 255.255.255.0
Recorder	IP=192.135.20.01	mask = 255.255.255.0

Refer to the definition of the classes of IP addresses.

Programming:

You can create your own software under Visual Basic, Visual C++, etc. for example with the Winsock.dll driver by Microsoft.

Then, you will only have to send the appliance instructions designed in the following paragraphs.

15.2. NTP Protocol

Using the NTP clock (network time protocol) gives triggers with accuracy better than 50 milliseconds (wait 1 hours for stabilization). For that, you need to install the recorder in your computer network with a fix IP.

Go to the Set-up page, then to the Ethernet page: 0.0.0.0

Give the recorder:

- The address of the gateway (IP of the router) (no use with DHCP)
- 2 address IP DNS (domain name system). The default addresses are Open DNS (208.67.222.222 and 208.67.220.220). Else, you can use DNS addresses by your Internet provider (for some servers, you only have to type the IP address of the gateway) (inutile en DHCP).
- A NTP server; the defaults server if the French NTP server: fr.pool.ntp.org. For more information, visit the website <http://www.ntp.org/>

You can use an internal NTP server inside your network or a server close to your home (preferably use secondary servers (layer 2) for France). You will find the list of the French servers in http://www.cru.fr/NTP/serveurs_francais.html

Once the appliance restarted, you can test if it can communicate with the various IP addresses.

In the Set-up page, go to the Date page:

You can select either the internal date or the synchronization of the appliance under NTP.

In this case, you must also tell the recorder your time shift and the possible use of daylight saving time (Europe only).

France and Western Europe are in the GMT+1 zone.

After restarting the appliance, the recorder will synchronize with the NTP server.

The date in the date window is displayed red when searching.

As soon as the synchronization process begins, the date is displayed blue.

If the date never turns blue, check the cables and the various IP addresses in the Ethernet page: you can test the link with the "test" line.

15.3. PTP protocol

You can use the protocol PTP Client mode.
With the IRIG option, you can also have a Server mode.

15.4. IRIG synchronization (optional)

The IRIG sync option, enhance the time measurement accuracy of data recorded in files mode (for sampling period ≥ 1 ms). The recorders equipped with IRIG board have an additional BNC connector, on the rear panel to assure the link with the external IRIG clock.

The configurations of the IRIG board are available in:

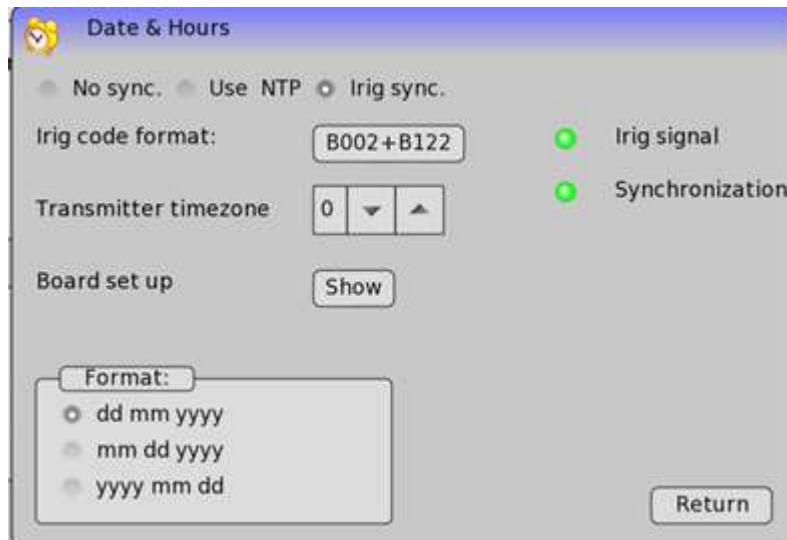
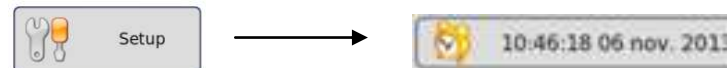

- **Irig code format** : Choose the format used by your external IRIG clock
- **Transmitter timezone**: Offset in hour for the received signal.
- **IRIG signal**: Green LED when the irig board is connected to a valid irig signal, red when unplugged.
- **Synchronization**: Green when the board is synchronized, red when not synchronized.
- **Board set up**: More information about the irig board

Synchronization indicator:

The internal clock is fully synchronized when the hour is displayed in blue in the state bar:



If the hour remains in red color, then the clock is not yet synchronized



In the case of a none correctly configured device, the hour will remains in black color. Go back in the precedently showed menu to configure the irig synchronization.

15.5. WIFI connection

You can also connect the appliance through a Wifi stick (SEFRAM thick only) by plugging it into a USB port. The wifi routed is used without encrypted key. Security is guaranteed by using MAC address. Once the stick inserted, go to the « Set-up » menu. Under Network, you should see a second line with « no more network ».

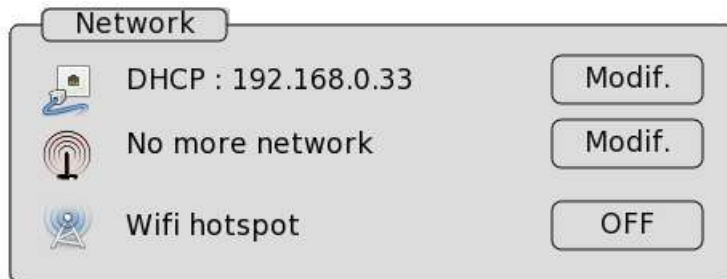

Pressing the « Modif. » key opens a utility program to activate the Wifi link.

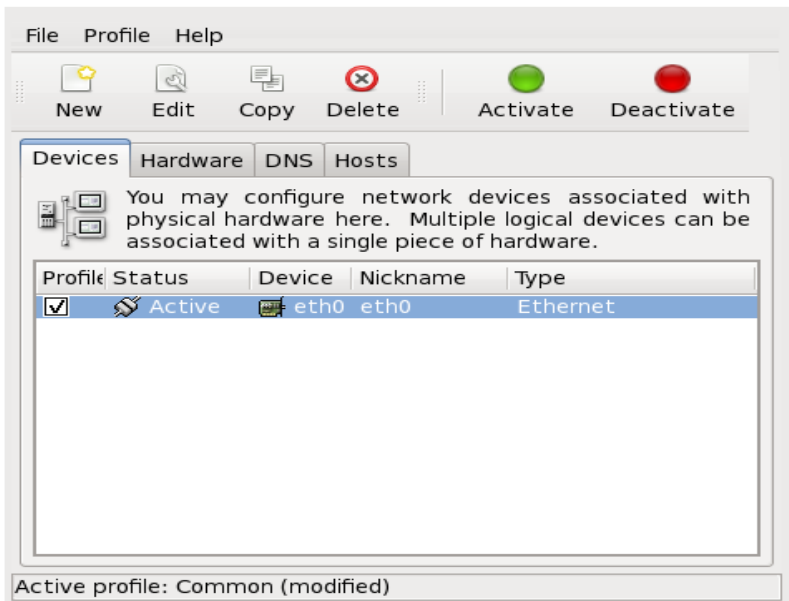

Then, go to the « Devices » tab and check that your Wifi stick has been identified.

Then, click « New » and select Wireless connection, then « Forward ».



The name of your Wifi stick shows up. Select it, then click « Forward ».



On this page, you must type the network parameters.

On the « network name (SSID): » line, you must select « Specified » and type the name of your network. If the wifi is protected by a wep key just enter it in the key subsection (wep is not available).

Then, you only have to follow the last steps of set-up and apply it.

After that, you Wifi peripheral should be visible in the list of configurable peripherals. In the « Modify » tab, you must: check "Activate the peripheral at start-up": the peripheral will automatically start up at energizing of the computer.

In the second tab you can see the MAC address of your wifi key

Don't forget to save the setup (files -> save)

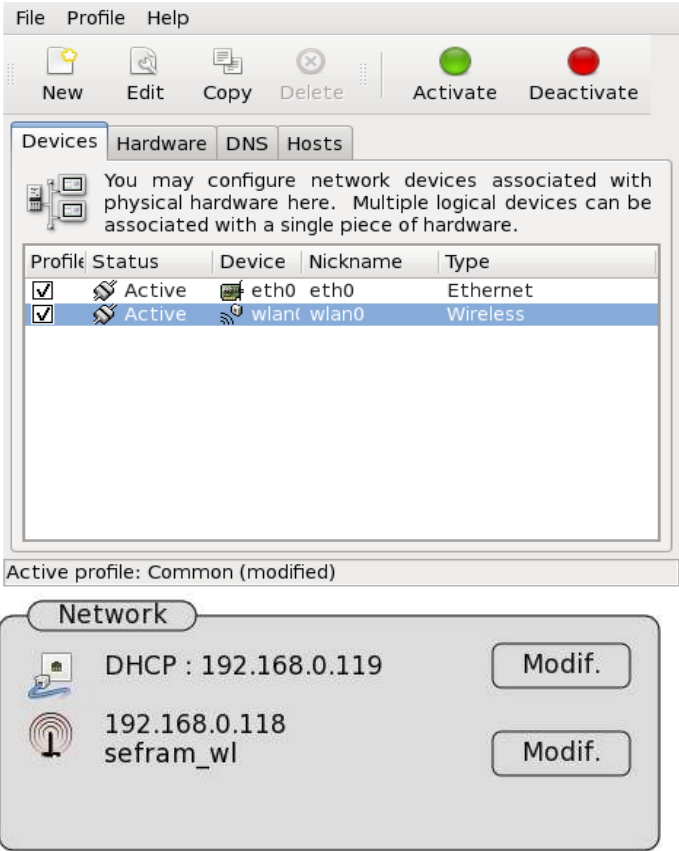

In case of trouble at setting up, click « Help » and then « Content » to display the help guide.

Once the network activated, and after a restart its name should show up in the Set-up menu under the Ethernet connection.

15.6. Create a wifi hotspot

A wifi hotspot can be launched in your device to make a direct connection between the DAS and any other wifi device such as PC, tablet, Smartphone

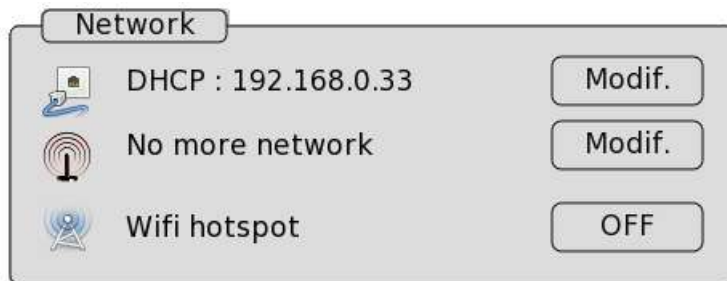

The hotspot is OFF. To turn on the wifi hotspot click on the off button. Validate your choice and restart the DAS with the wifi key plugged in.



The wifi key must be plugged when the device is started.
When the wifi hotspot is on, it is not possible to connect the DAS to other wifi networks. To be able to do such a thing, turn off the hotspot.

The hotspot configuration is:

Hotspot name	:SeframRecorder
Password	:sefram00

15.7. Operating software

You can transfer the data acquisitions files to a PC computer.

The SeframViewer software is provided on a CD-ROM with the appliance. It displays the recorded files.

It works under win XP, 2000, Vista, Win7 with Framework 2.0

Using files on a PC requires two steps:

- Transfer the files from the appliance to the PC with the FTP protocol with your Internet browser, for example
- Display of the files with the SeframViewer software

15.7.1. File transfer under FTP

- Use FileZilla (see the CD)

This process is recommended because the date of the transferred files will be identical with the date of the initial files. In addition, the transfer speed will be optimal

- **Using the explorer of Windows (IE9 for example)**

Go to Tools → Connect a network reader

Click « Open a storage session or a network server »

Under « Internet network address », type ftp:// and the IP address of your recorder

You can give a name to this link; it will always remain active among the « network favorites »

- **Using a web browser** (internet explorer, Firefox, opera etc.)

Launch your browser and type the connection address (See chapter **Set-up**):

« **Ftp://** » and the IP address of your recorder

Then press « Enter » from your computer.

You have direct access to the directories of your recorder, including the data acquisition files: **HD**: main directory on the internal hard disk of your appliance

Transfer your files to your computer to use them with the provided SeframViewer software or FLEXPLO.

15.7.2. Display under SeframViewer

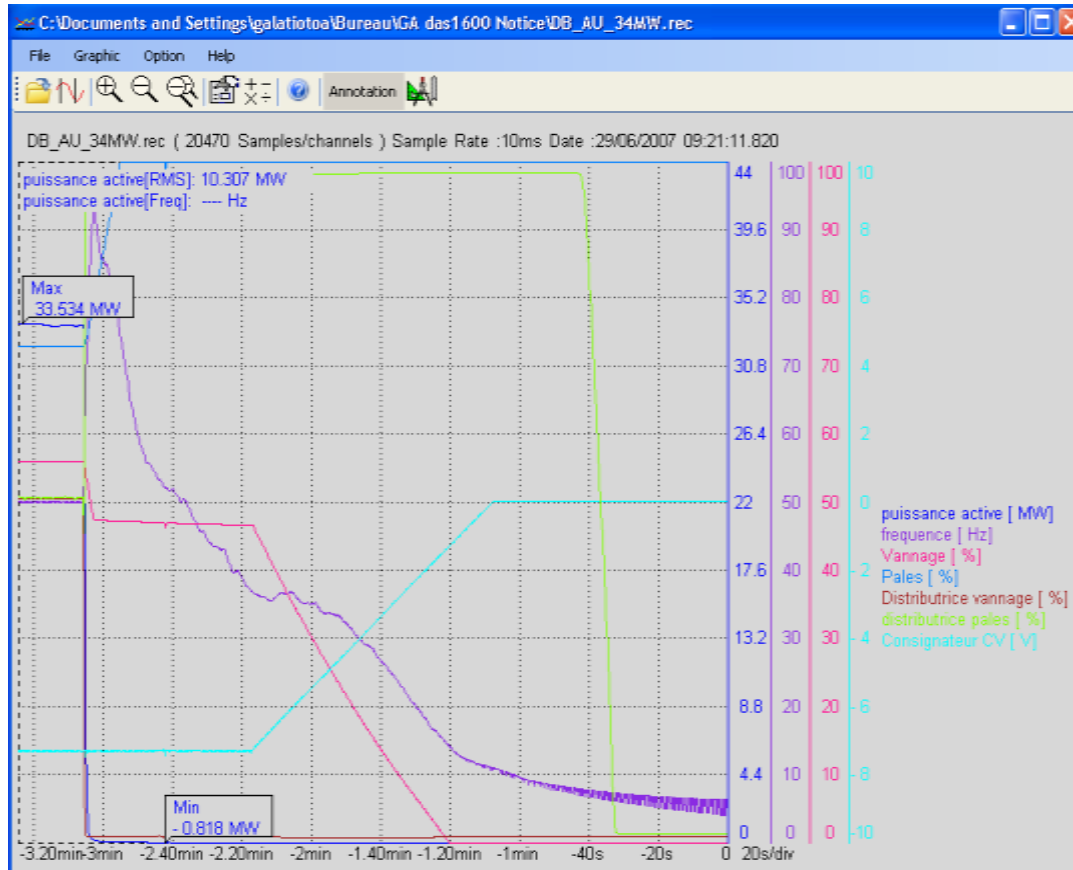

Launch the SeframViewer software (or double-click on a file) then open a .REC file.

You can select:

- the channels to display
- the f(t) or xy mode
- the autocalibration of the channels.

Your data acquisition file is displayed on screen. All functions of SeframViewer are available.

Use the user manual included with the software to discover all the available functions of SeframViewer by clicking the last icon « **Detailed help** ».

In command mode of Windows[®], you can also directly create a result file (text or Excel file) by typing the following line (see Menu sub-menu Options of the help):

SeframViewer myfiler.rec /x creates an Excel file

SeframViewer myfile.rec /t creates a text file.

15.7.3. Control with VNC Viewer:

This software makes it possible to remotely control the recorder.

<http://www.realvnc.com/download/vnc/> allows you to easily download the software. Select the.exe file.

You only have to follow the instructions of the site to install the software. At the end of the installation, you can choose a version for your VNC viewer (some versions are charged). Select the version you want according to the desired applications.

You only have to open the « VNC viewer » where you downloaded it.

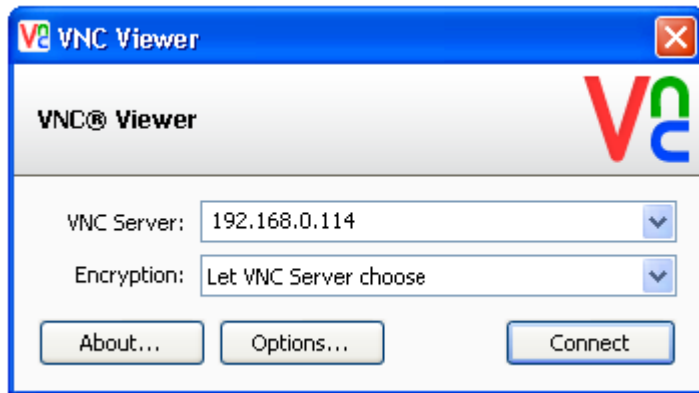

On the VNC Server line, you must type the IP address of your recorder and click « Connect »

You will be able to control your recorder with your computer.

16. TECHNICAL SPECIFICATIONS

16.1. Isolated 1000V inputs

16.1.1. General characteristics

Number of inputs per module 6

Impedance:

11M Ω impedance for calibers < 10Volts

10M Ω impedance for other calibers

Maximum admissible voltage:

Between the measured channel and the mechanical ground : 1000 V DC or 1000 V AC 50 Hz

Between the two channels' poles : 1000 V DC or 1000 V AC 50 Hz

Installation category: overvoltage category: III-1000V and category IV-600V

Isolation: Between the ground and the measurement channels: >100 M Ω for 1500 V DC.

Common mode parasites: Test according to EN 61143

Kind of measures:

Voltage, current (with external shunt), frequency

16.1.2. Voltage record

<i>Maximum caliber</i>	4000 V	(-2000 V to +2000 V)
<i>Minimum caliber</i>	100 mV	(-50 mV to +50 mV)
<i>Offset</i>	Adjustment of the center per 1/5000 of the full scale or 1/2 caliber	
<i>Maximum offset</i>	+ 5 calibers.	(Without exceeding the range from -2000V to + 2000V)
<i>Accuracy</i>	+/-0.2 of the full scale +/- 0.2% of the offset	
<i>Offset shift</i>	100ppm/°C	

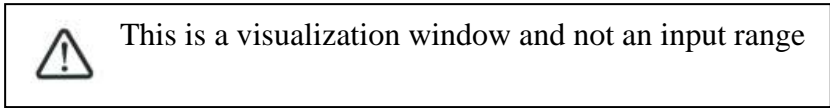

16.1.3. RMS record

Software RMS calculation

<i>Sampling</i>	200 μs
<i>Max frequency</i>	500 Hz
<i>Peak factor</i>	2, 2 and 2000 V max. Instantaneous
<i>Accuracy</i>	+/- 1 % (sinusoidal signal)
<i>Response delay</i>	100 ms typical (40 ms @ 50 Hz)
<i>Max measurable voltage</i>	1000V AC

16.1.4. Derivative and integral record

Integration time: (common to all channels) from 200 μs to 1 s

Input Caliber: adjustable from ± 0.50 mV to ± 2000 V

Input filters: see bandwidth paragraph

16.1.5. Frequency record

Accuracy 100 mV rms min.
 Decision threshold: Variable from -99 V to 99 V with 0.1 V steps
 (valid for frequencies < 10 Hz)
min. cyclic ratio 10%
Frequency between 1 Hz and 100 kHz.
Accuracy 0.02% of the full scale

16.1.6. Counting record

Decision threshold: Variable from -99 V to 99 V with 0.1 V steps
 Min. Sensitivity: +100 mV + 1% of the decision threshold
 Max. Counting for record: 65536 (at higher values, the counter is zeroed).
 Max. Digital Counting: $4 \cdot 10^9$

16.1.7. Sampling

Resolution: 14 bits
Max sampling frequency: 1 μ s (= 1 MHz)
Max sampling period. : 10 min

16.1.8. Bandwidth

-3 dB bandwidth:

Caliber	Bandwidth
≥ 100 V	26 KHz
≥ 10 V and <100V	20 kHz
<10V	3 kHz

Internal analog filters: 10 KHz, 1 KHz, 100 Hz, (20 dB/decade)

16.1.9. Numeric filters

Programmable 0.01 Hz to 100Hz

Slope: 40 db/decade

Sampling: 5 KHz

Period of calculation:

- Record $\geq 200\mu\text{s}$ or oscilloscope time base $\geq 20\text{ms/div}$: $200\mu\text{s}$
- Record $\leq 100\mu\text{s}$ or oscilloscope time base $\leq 10\text{ms/div}$: 5ms

16.2. Isolated 500V inputs

16.2.1. General characteristics

Number of inputs per module 6

Impedance:

Impedance > 25 M Ω for calibers \leq 0.5 V
 Impedance = 1 M Ω for the calibers > 0.5 V

Optional card 984402300:

Impedance = 10 M Ω for the calibers > 0.5 V

Maximum admissible voltages:

Between the measurement channel and the mechanical ground: + 500 V DC or 500 V AC 50 Hz
 Between the 2 poles of a channel: + 500 V DC or 500 V AC 50 Hz

Category of installation: overvoltage category: III 600 V

Isolation: between the ground and the measurement channel: >100 M Ω under 500 V DC.

Parasites of common mode: test according to the norm EN 61143

Type of measurements:

Voltage, intensity (through external shunt)
 Frequency
 Thermocouple J, K, T, S, B, N, E, C, L

16.2.2. Voltage recording

<i>Max. Range</i>	1000 V	(-500 V to +500 V)
<i>Min .Range</i>	1 mV	(-0.5 mV to +0.5 mV)
<i>Offset</i>	Adjustment of the center per 1/5000 of the full scale or 1/2 caliber	
<i>Max Offset</i>	+ 5 ranges (except 1000 V)	
<i>Accuracy</i>	$\pm 0.1\%$ of full scale $\pm 10 \mu\text{V}$ $\pm 0.1\%$ of the offset	
<i>Offset shift</i>	100 ppm/°C $\pm 1 \mu\text{V}/^\circ\text{C}$	
<i>Classe C index</i>	see appendix	

16.2.3. RMS recording

RMS calculation with the software

<i>Sampling</i>	200 μs
<i>Max. Frequency</i>	500 Hz
<i>Peak factor</i>	2.2 and 600 V max. Instantaneous
<i>Accuracy</i>	$\pm 1\%$ (sine signal)
<i>Response delay</i>	100 ms typical (40 ms @ 50 Hz)
<i>Measureable max. Voltage</i>	424 V AC

16.2.4. Derivative and integral record

Integration time: (common to all channels) from 200 μs to 1 s

Input Caliber: adjustable from $\pm 0.5 \text{ mV}$ to $\pm 500 \text{ V}$

Input filters: see paragraph bandwidth

16.2.5. Temperature record

Sensor	Domain of use
J	-210°C to 1200 °C
K	-250°C to 1370 °C
T	-200°C to 400 °C
S	-50°C to 1760 °C
B	200°C to 1820 °C
E	-250°C to 1000 °C
N	-250°C to 1300 °C
C	0°C to 2320 °C
L	-200°C to 900 °C

Accuracy of the thermocouples as specified in the appendix

Compensation of the cold junction of the thermocouples J, K, T, S, N, E, C, L: ± 1.25 °C

Calculation every ca. 5 ms.

16.2.6. Frequency record

Accuracy 100 mV rms min.
 Decision threshold: Variable from -99 V to 99 V with 0.1 V steps
 (Valid for frequencies < 10 Hz)
min. cyclic ratio 10%
Frequency between 10 Hz and 100 kHz.
Accuracy 0.02% of the full scale

16.2.7. Counting record

Decision threshold: Variable from -99 V to 99 V with 0.1 V steps
 min. Sensitivity: +100 mV + 1% of the decision threshold
 max. Counting for record: range 10000000 max
 max. digital Counting: $4 \cdot 10^9$

16.2.8 PWM record

Decision threshold: Variable from -99 V to 99 V with 0.1 V steps
 min. Sensitivity: +100 mV + 1% of the decision threshold
 Value between 0 and 100 %
 Accuracy : 0.1% from 10 Hz to 1 kHz
 0.5% from 1 kHz to 5 kHz

16.2.9. Sampling

Accuracy: 14 bits
max. Sampling Frequency: 1 μ s (= 1 MHz)
max. Sampling Period: 10 min

16.2.10. Bandwidth

Bandwidth at -3 dB:

Caliber	Bandwidth
> 1 V	100 kHz
> 50 mV	50 kHz
20 mV	30 kHz
10 mV	30 kHz
5 mV	20 kHz

Carte optionnelle 984402300 :

Caliber	Bandwidth
>10V	>20 kHz
> 500 mV	>10 kHz
> 50 mV	>50 kHz
20 mV	>30 kHz
10 mV	>30 kHz
5 mV	>20 kHz

Analogical Filters: 10 kHz ,1 kHz, 100 Hz, 10 Hz
 Slope : 20 dB/decade

Numeric Filters: *see § 16.1.9*

16.3. Multiplexed inputs

16.3.1. General Characteristics

Number of inputs per module 12

Inputs of type non-isolated differential

Impedance:

Impedance >10 M Ω for calibers \leq 2 V

Impedance = 2 M Ω for all other calibers

Maximum admissible voltages:

between the measurement channel and the mechanical ground: 48 V DC

between the 2 poles of a channel: 48 V DC

Max. common mode Voltages:

\pm 3 V for calibers \leq 2 V

\pm 50 V for all other calibers

Type of measurements:

Voltage, intensity (through external shunt)

Thermocouple J, K, T, S, B, N, E, C, L

PT100 2, 3 or 4 wires

16.3.2. Voltage record

Max. Caliber 50 V (-25 V to +25 V)

Min. Caliber 1 mV

Offset software adjustment of the center

Accuracy \pm 0.1% of full scale \pm 10 μ V \pm 0.1% of the offset

Offset shift 100 ppm/ $^{\circ}$ C \pm 1 μ V/ $^{\circ}$ C

16.3.3. RMS record

Software RMS calculation

<i>Sampling</i>	200 μ s
<i>Peak factor</i>	2.2
<i>Response delay</i>	typically 100 ms
<i>Max. Frequency</i>	100 Hz
<i>Accuracy</i>	\pm 1% (sine signal)

16.3.4. Counting record

Decision threshold:	Variable from -10 V to 10 V with 0.1 V steps
min. Sensitivity:	+100 mV + 1% of the decision threshold
max. Counting for record:	range 10000000 max
minimum pulse :	200 μ s
max. digital Counting:	4. 10^9

16.3.5. Derivative and integral record

Integration time: (common to all channels) from 200 μ s to 1 s

Input Caliber: adjustable from \pm 0.5 mV to \pm 25 V

Input Filters: see Paragraph Bandwidth

16.3.6. Temperature record

- Thermocouple: see chapter 16.1.4
- PT100:
 - Domain of use from -200 to 850 $^{\circ}$ C
 - Accuracy of the thermocouples and PT100: see the appendix, PT100 2, 3 or 4 wires.
 - Calculation every ca. 5 ms
 - Max. Corrective resistance:*
- PT100 2 wires: 30 Ω - PT100 3 wires: 100 Ω

16.3.7. Sampling

<i>Resolution:</i>	16 bits
<i>Max. Sampling Period:</i>	
Memory and file modes:	200 μ s (= 5 kHz)
<i>Max. Sampling Period:</i>	10 min

16.3.8. Bandwidth

<i>Bandwidth at -3 dB</i>	1 kHz
<i>Numeric Filters:</i>	<i>See § 16.1.9</i>

16.4. Strain gauge inputs

16.4.1. General characteristics

Number of inputs per module: 6

Voltage, thermocouple and strain gauge measurement (the strain gauge bridge is powered by the drawer)

Inputs of type isolated differential

Impedance:

2 M Ω for calibers \leq 1 V

1 M Ω for calibers $>$ 1 V

Maximum admissible voltages:

Between a measurement input or the ground and the mechanical ground: 200 V DC

Maximum voltages between inputs, between input and drawer ground: \pm 50 V

Isolation: between mechanical ground and measurement channel: $>$ 1000 M Ω under 500 V

Type of measurements:

Voltage, intensity (through external shunt), thermocouple, strain gauge

The accuracy values below are specified for the 1Hz filter.

16.4.2. Voltage record

Max. Caliber 50 V

Min. Caliber 1 mV

Offset adjustment of the center by 1/5000 of full scale or 1/2 caliber

Max. Offset \pm 50 V (zero offset \pm 5 calibers without changing the caliber)

Accuracy \pm 0.1% of full scale \pm 10 μ V \pm 0.1% of the offset

Offset shift 100 ppm/ $^{\circ}$ C \pm 1 μ V/ $^{\circ}$ C

Noise $<$ 20 μ V without a filter

16.4.3. RMS record

Software RMS calculation

<i>Resolution</i>	200 μ s
<i>Max. Frequency</i>	500 Hz
<i>Peak factor</i>	2, 2
<i>Accuracy</i>	± 1 % (sine signal)
<i>Response delay</i>	typically 100 ms

16.4.4. Derivative and integral record

Integration time: (common to all channels) from 200 μ s to 1 s

Input Caliber: adjustable from ± 0.5 mV to ± 25 V

Input Filters: see paragraph Bandwidth

16.4.5. Strain gauge record

The selected unit is μ STR (micro strain). Gauges also express the measurement in mV/V

The equivalence is: 2000 μ STR = 1 mV/V

<i>Automatic Zero</i>	± 25000 μ STR
<i>Power Voltage of the bridge</i>	2 V and 5 V (symmetrical ± 1 V and ± 2.5 V)
<i>Gauge Coefficient</i>	2 (adjustable between 1.8 and 2.2)
<i>Max. Caliber</i>	50 000 μ STR
<i>Min. Caliber</i>	1000 μ STR
<i>Offset</i>	adjustment of the center by 1/5000 of full scale or 1/2 caliber
<i>Max. Offset</i>	± 50000 μ STR
<i>Accuracy</i>	$\pm 0.1\%$ of full scale ± 5 μ STR $\pm 0.1\%$ of the offset
<i>Offset shift</i>	100 ppm/ $^{\circ}$ C ± 1 μ V/ $^{\circ}$ C

16.4.6. Temperature record

- Thermocouple: see § 17.1.4
- PT100:
 - Domain of use from -200 to 850 °C
 - Accuracy: see appendix
 - PT100 2 or 4 wires
 - Calculation every ca. 5 ms
 - Max. Corrective Resistance:*
 - 2-wire PT100: 30 Ω

16.4.7. Sampling

<i>Accuracy:</i>	16 bits
Max. Sampling Period	
<i>Memory and File modes:</i>	10 μs (= 100 kHz)

16.4.8. Bandwidth

<i>Bandwidth @ -3 dB</i>	>18 kHz
<i>Analogical low-pass Filters 20 dB / decade</i>	1 kHz, 100 Hz,
<i>Numeric Filters:</i>	See § 16.1.9

16.5. Additional Inputs / Outputs

16.5.1. Logic channels

<i>Number of channels</i>	16
<i>Input Impedance</i>	4.7 k Ω
<i>Sampling Frequency</i>	same as the main inputs
<i>Max. Admissible Voltage</i>	24 V

16.5.2. Alarm Outputs

<i>Alarm A</i>	voltage-free contact (relay) (24 V / 100 mA).
<i>Alarms B and C</i>	TTL outputs 5 V

Voltage-free appliance when the circuits are open.

16.5.3. External power supply

<i>Nominal Voltage</i>	12 V / mechanical ground
<i>Max. Intensity</i>	0.2 A restricted by reloading fuse

16.6. Circuit analysis

The specified accuracies require that the nominal values are correct.

16.6.1. Ranges and Accuracies Voltage and Intensity

RMS Voltage:

- Range: from 1 mVrms to 400 Vrms
- Accuracy: 0.5% of the nominal voltage

RMS Intensity:

- Range: the intensity is always to be referred to a corresponding voltage: the input value must be within the limits specified for the voltage. In most cases, the instrument you are using to measure the intensity conditions the measuring range.
- Accuracy: 0.5% of the nominal intensity + error margin of the measuring instrument

Active power:

- Accuracy: Intensity error margin + Voltage error margin

Example

Measurement of a 230 V voltage and a 10 A intensity with a SP221 clamp (1% accuracy; input 1 A yields output 100 mV on the circuit analyzer).

- *Voltage:* accuracy 0.5 %
- *Intensity:* accuracy $0.5\% + 1\% = 1.5\%$
- *Power:* accuracy $0.5\% + 1.5\% = 2\%$

Power supply voltage and frequency of the appliance:

In the case where the recorder is in nominal functioning conditions (see chapter 10.7), the influence errors resulting from the power supply voltage and frequency are negligible within 10% distortion and $\pm 2\%$ frequency variation (in case of circuit power supply by generating unit).

Magnetic fields:

The current sensors must compulsory be in conformity with the valid norms and have the CE mark. Their influence on the recorder is negligible for a field 100 A/m @ 50 Hz. As far as possible, keep the sensors away from any magnetic source when used.

16.6.2. Frequency

Ranges: from 10 to 100 Hz - 400 Hz \pm 20% - 1000 Hz \pm 20%
Accuracy: 0.01 Hz
Sensitivity: 5% of the nominal voltage

16.6.3. Power factor

Accuracy: measurement value \pm 0.05

16.6.4. Peak factor

Peak accuracy: 0.5% of the nominal voltage or intensity
Peak factor: accuracy 1 % up to 5

16.6.5. Harmonics rate calculated in power analysis

Range: THD: from 0 % to 600 %
 FD: from 0 % to 100 %
Accuracy: measurement value \pm 2%

Harmonics: ca. 2 up to order 50
Range: from 0 % to 600 %
Accuracy: measurement value \pm 1 % up to the 30th harmonics;
 Measurement value \pm 1.5 % from the 31st up to the 50th harmonics

16.6.6. Multiple circuits

Available only when multiples board 500V or 1000V are available.

16.7. Display

<i>Screen</i>	TFT 15.4 inches, color, back-lighted LED
<i>Total Accuracy</i>	1280x800 dots

16.8. Memory acquisition

<i>Memory length</i>	128 Msample (partible up to 128 blocks)
<i>Max. Sampling Period</i>	10 min
<i>Max. Sampling Frequency</i>	1 MHz
<i>Accuracy</i>	50 ppm

Position of the triggers -100% to +100%

16.9. Acquisition on files

<i>Internal hard disk size</i>	500 Go min.
<i>Max. Transfer rate</i>	6 Msample /s
<i>Accuracy</i>	50ppm

The true transfer rate depends on the number of channels to get and on the current mode.

16.10. Communication interface

Communication (remote control) only through Ethernet. Possible DHCP

<i>Speed</i>	10/100/1000 base-T
<i>Connector</i>	RJ45
<i>Protocol</i>	TCP/IP
<i>Connection port</i>	23
(Use the EMI filter)	

16.11. Thermal paper

Paper dimension	270mm
Drawing dimension	256mm
Running speed of the paper	from 1mm/h to 100mm/s or external speed
Re-transcription of the memory	10mm/s max
Fast lead	100mm/s
Text mode	period of 1second/line to 1 line/hour
XY mode	100x100, 200x200, 250x250 mm

Resolution and accuracy:

In X axle:	8 points per mm
In Y axle:	16 points per mm to 50 mm/s
	8 points per mm beyond
In XY mode:	8 points per mm on the 2 axles

Accuracy of the running speed: 0,5 (<100mm/s)

16.12. Miscellaneous

16.12.1. USB connector

For a keyboard, a mouse for printer and memory sticks or wifi sticks

Type 4 connectors USB-2 at the rear + 2 connectors USB-2 at the front

16.12.2. Screen connector

Type DB15, 15 dots high density

16.13. Environmental conditions for the 8460 recorder

16.13.1. Environmental conditions

<i>Working temperature</i>	0°C to 40°C
<i>Max. Relative humidity</i>	80 % condensation-free
<i>Storage temperature</i>	-20°C to 60°C

16.13.2. Mains/Power supply

<i>Voltage range</i>	100VAC to 264 VAC
<i>Frequency</i>	47 to 63 Hz
<i>Inrush current</i>	< 38 A peak
<i>Consumption</i>	230 W max. (80W without drawing)

16.13.3. Dimensions and weight

<i>Height</i>	195 mm
<i>Width</i>	440 mm
<i>Depth</i>	370 mm
<i>Weight</i>	11 kg

16.14. Environmental conditions DAS 1600/DAS800/DAS801

16.4.1. Weather conditions

<i>Working temperature</i>	0°C to 40°C (0°C to 30°C for the DAS1600SV option and DAS800SV and DAS801SV)
<i>Max. Relative humidity</i>	80 % condensation-free
<i>Storage temperature</i>	-20°C to 60°C

16.4.2. Mains

<i>Voltage range</i>	99 V AC to 264 V AC
<i>Frequency</i>	47 to 63 Hz
<i>Inrush current</i>	< 40 A peak
<i>Consumption</i>	55 W max.

Internal fuse not accessible to the user: contact the after-sales service by SEFRAM

16.14.3. Dimensions and weight

<i>Height</i>	298 mm
<i>Width</i>	394 mm
<i>Depth</i>	218 mm
<i>Weight DAS1600</i>	8 kg

With Extension:

<i>Depth</i>	295mm
<i>Weight DAS1600</i>	10kg

16.15. Electromagnetic compatibility, security

16.15.1. Electromagnetic compatibility DAS1600/DAS800

Désignation	Méthode d'essai	Spécification	Limite/Niveau	Essai applicable	Classe/ Critère
Émission rayonnée	NF EN 55011 (2010) *	30 MHz à 230 MHz 230 MHz à 1 GHz	Mesure à 3 mètres 50 dBµV/m QP 67 dBµV/m QP	Oui	Classe A
Émission conduite (accès alim. AC.)	NF EN 55011 (2010) *	0,15 MHz à 0,5 MHz 0,5 MHz à 5 MHz 5 MHz à 30 MHz	79 dBµV QP 73 dBµV QP 73 dBµV QP (Valeur AV = QP-13 dB)	Oui	Classe A
Courant harmonique	CEI 61000-3-2 (2005)	-	-	Non (1)	-
Variation de tension et flicker	CEI 61000-3-3 (2008)	-	-	Non (2)	-
Immunité enveloppe	CEI 61000-4-2 (2008) *	Décharges Contact Air	N = ± 4 kV N = ± 8 kV	Oui	Critère B
	CEI 61000-4-3 (2008) *	80 MHz à 1 GHz 1,4 GHz à 2,0 GHz AM 80% 1000 Hz	10 V/m sans modulation 3 V/m sans modulation	Oui	Critère A
	CEI 61000-4-3 (2008) *	2,0 GHz à 2,7 GHz AM 80% 1000 Hz	3 V/m sans modulation	Oui (3)	Critère A
	CEI 61000-4-8 (2009)	-	-	Non (4)	-
Immunité accès Alim AC	CEI 61000-4-4 (2004) *	5-50 ns / 5 kHz	± 2 kV	Oui	Critère B
	CEI 61000-4-5 (2005) *	1,2/50 µs	Ligne/Ligne : ± 1 kV Ligne/Terre : ± 2 kV	Oui	Critère A
	CEI 61000-4-6 (2008) *	150 kHz à 80 MHz AM 80% 1000 Hz.	3 Vrms sans modulation	Oui	Critère A
	CEI 61000-4-11 (2004) 85V * 250V * (5) 264V	Réduction 100% 1 période Réduction 80% 10 périodes Réduction 30% 25 périodes Réduction 100% 250 périodes		Oui	Critère B Critère C Critère A Critère C
Immunité Autres câbles	CEI 61000-4-4 (2004) *	5-50 ns / 5 kHz	± 1,0 kV	Oui (7)	Critère A
	CEI 61000-4-5 (2005)	1,2/50 µs	Ligne/Terre : ± 1 kV	Oui (8)	Critère A
	CEI 61000-4-6 (2008) Câble terre * Câble Ethernet	150 kHz à 80 MHz AM 80% 1000 Hz	3 Vrms sans modulation	Oui (7)	Critère A

* Test conditions: connection of the tested equipment with a cable connected to the ground pole of the frame (benchmark 9, paragraph 2.2.1); see paragraph 3.4.6 Earth

Assessment criteria for the function applied during the test:

Criterion A: Normal behavior within the limits of specification.

Criterion B: Temporary self-recoverable deterioration or loss of function.

Criterion C: Temporary deterioration or loss of function requiring an intervention by the user or a reset of the system.



This is a class A device. Class A devices are meant to be used in an industrial environment. Electromagnetic compatibility is not ensured in others environments.

16.15.2. Electromagnetic compatibility 8460

Désignation	Méthode d'essai	Spécification	Limite/Niveau	Essai applicable	Classe/Critère
Émission rayonnée	NF EN 55011 (2010) *	30 MHz à 230 MHz 230 MHz à 1 GHz	Mesure à 3 mètres 50 dB μ V/m QP 57 dB μ V/m QP	Oui	Classe A
Émission conduite (accès alim. AC.)	NF EN 55011 (2010) *	0,15 MHz à 0,5 MHz 0,5 MHz à 5 MHz 5 MHz à 30 MHz	79 dB μ V QP 73 dB μ V QP 73 dB μ V QP (Valeur AV = QP-13 dB)	Oui	Classe A
Courant harmonique	CEI 61000-3-2 (2005)	--	--	Non (1)	--
Variation de tension et flicker	CEI 61000-3-3 (2008)	--	--	Non (1)	--
Immunité enveloppe	CEI 61000-4-2 (2008)	Décharges Contact Air	N = \pm 4 kV N = \pm 8 kV	Oui	Critère A
	CEI 61000-4-3 (2006) *	80 MHz à 1 GHz 1,4 GHz à 2,0 GHz AM 80% 1000 Hz	10 V/m sans modulation 3 V/m sans modulation	Oui	Critère A
	CEI 61000-4-3 (2006) *	2,0 GHz à 2,7 GHz AM 80% 1000 Hz	3 V/m sans modulation	Oui (2)	Critère A
	CEI 61000-4-8 (2009)	--	--	Non (3)	--
Immunité accès Alim AC	CEI 61000-4-4 (2004) *	5-50 ns / 5 kHz	\pm 2 kV	Oui	Critère A
	CEI 61000-4-5 (2005) *	1,2/50 μ s	Ligne/Ligne : \pm 1 kV Ligne/Terre : \pm 2 kV	Oui	Critère A
	CEI 61000-4-6 (2008)	150 kHz à 80 MHz AM 80% 1000 Hz	3 Vrms sans modulation	Oui	Critère A
	CEI 61000-4-11 (2004) 99V * 250V * (4) 264V	Réduction 100% 1 période Réduction 60% 10 périodes Réduction 30% 25 périodes Réduction 100% 250 périodes	Oui	Critère B Critère A Critère A Critère C	
Immunité Autres câbles	CEI 61000-4-4 (2004) *	5-50 ns / 5 kHz	\pm 1,0 kV	Oui (5)	Critère A
	CEI 61000-4-5 (2005)	1,2/50 μ s	Ligne/Terre : \pm 1 kV	Oui (6)	Critère A
	CEI 61000-4-6 (2008)	150 kHz à 80 MHz AM 80% 1000 Hz	3 Vrms sans modulation	Oui (5)	Critère A

Test conditions: EUT connection (equipment under test) thanks to a line connected to the chassis earth ground (indication 9, section 2.2.1); see section 3.4.5 ground connection

Operating evaluation standards applied during the test:

Criterion A: normal performance in the specification limits

Criterion B: temporary degradation or loss of auto-recyclable function

Criterion C: temporary degradation or loss of function or performance which needs an user action or a reset.



This instrument is a Class A appliance.

Class A appliances are intended to use in industrial environments, you can face potential difficulties to ensure the electromagnetic compatibility in other environments because of conducted and spread disturbances.

16.15.3. Security, Isolation Class, Installation Category

Class 1 product

Security conform with EN61010-1

Pollution degree 2

Installation category (overvoltage category)

Mains input category II

Measurement input category III 600 V, overvoltage 6000 V



Particular precautions are necessary to preserve the conformity of the product, particularly the use of shielded cables.

16.16. Miscellaneous

16.16.1. Internal saving battery

Saving the configurations and the clock

Battery lithium 3.0V button battery

Preservation of the data min. 5 years

The user cannot change it: contact the after-sale service.

16.17. Accessories

16.17.1. Accessories provided with the appliance

User manual

Help CD with software and notes

Common accessories:

- 1 mains cable 241510312
- 1 female 25-pin connector 214200251
- 1 connector hood 214299014
- 1 mouse 298505112
- 1 RJ45 filter

- | | |
|---|-----------|
| Accessories isolated 6-channel module: | 984401100 |
| • 1 black banana plug per channel | 215508020 |
| • 1 red banana plug per channel | 215508021 |
| Accessories multiplexed differential 12-channel module: | 984402100 |
| • 1 screw terminal block per channel | 315018045 |
| Accessories isolated gauge strain 6-channel module | 984402550 |
| • 1 screw terminal block per channel | 315018048 |

16.17.2. Accessories and options

Universal 6-channel module	see the after-sales service
Universal 6-channel module (10 M Ω inputs)	984402300
Gauge strain 6-channel module	see the after-sales service
Multiplexed 12-channel module	see the after-sales service
1000V 6-channel module	see the after-sales service
Transportation case	984167000
Rack 19" (DAS800/1600)	916007000
Crossed Ethernet connection	910007300
FLEXPRO software basis	910008100
FLEXPRO software complete	910008200

Shunt 0.1 Ω 1% 1 A plug-in	910007200
Shunt 1 Ω 0.1% 0.5 A plug-in	989006000
Shunt 10 Ω 0.1% 0.15 A plug-in	912008000
Shunt 50 Ω 0.1% 0.05 A plug-in	989007000
Shunt 0.01 Ω 0.5% 30 A external (plugs)	207030301
Shunt 0.001 Ω 0.5% 50 A external (terminals)	207030500

16.17.3. Consumable items

Kit for 6-channel module	984010000
Kit for 12-channel module	984402100
Roller paper 30m (standard)	837500504
Roller paper 30m long duration	837500510
Roller paper 30m high sensitivity	837500521
Pre-cut Roller paper A4	837500522

16.18. Battery option

DAS 1600/800/801 can be equipped with and an optional battery preventing the loose of data in case of power shutdown. The option specifications are detailed below:

<i>Battery charging time with the DAS turned off</i>	<3h
<i>Battery charging time with the DAS turned on</i>	<6h
<i>Battery autonomy</i>	>2h

The front LED of the battery powered devices has three operating modes:

- LED lights up: The device is ON (Push button ON).
- LED is off: The device is off and not connected to an external power source (Back switch button OFF, and push button OFF)
- LED is blinking: The device is off and connected to an external power source. (Back switch button ON, and push button OFF).

The led is not a battery charge indicator. To check the battery charge, use the charge icon in the device's status bar when this one is turned on.



The battery is charging.



The device is powered by the battery.



The use of the battery requires **imperatively** to plug the device's protection earth or the power supply wire for safety reasons
For the devices powered by a battery, plugged to 500V board, the maximum number of board authorized is lowered to 3..

16.19. IRIG board option

Synchronize your data with an external IRIG clock to enhance time measurement accuracy.

Accuracy of trigger date 5ms

Sampling time accuracy $10^E -12$ (only for sampling rate $\geq 200\mu s$) (< 5 KHz)

<i>IRIG formats</i>	IRIG-A133, A132, A003, A002, B123, B122, B003, B002 and AFNOR NFS 87-500
<i>IRIG signal amplitudes</i>	from 600mVpp to 8Vpp
<i>Input impedance</i>	50 Ohms

17. APPENDIX

17.1. Information about the caliber of the inputs

Reminder: The caliber is the difference between the max. and min. displayable value on screen or paper.
The origin is the middle of the screen or paper.

17.1.1. Inputs of isolated voltage type

CALIBER	Origin offset	Min. Measurable	Max. measurable
1 mV	±5 mV	-5.5 mV	+5.5 mV
2 mV	±10 mV	-11 mV	+11 mV
5 mV	±25 mV	-27.5 mV	+27.5 mV
10 mV	±50 mV	-55 mV	+55 mV
20 mV	±100 mV	-110 mV	+110 mV
50 mV	±250 mV	-275 mV	+275 mV
100 mV	±500 mV	-550 mV	+550 mV
200 mV	±1 V	-1.1 V	+1.1 V
500 mV	±2.5 V	-2.75 V	+2.75 V
1 V	±5 V	-5.5 V	+5.5 V
2 V	±10 V	-11 V	+11 V
5 V	±25 V	-27.5 V	+27.5 V
10 V	±50 V	-55 V	+55 V
20 V	±100 V	-110 V	+110 V
50 V	±250 V	-250 V	+250 V
100 V	±450 V	-500 V	+500 V
200 V	±400 V	-500 V	+500 V
500 V	±250 V	-500 V	+500 V
1000 V	0	-500 V	+500 V

These inputs are equipped with an analogical offset system of the origin that may reach up to ± 5 times the caliber value. Hence, you have to shift the measurement limits without changing the resolution up to 5 times the caliber value.

The software allows you to program any caliber and any offset; then, it selects the real analogical caliber and the best adapted offset according to the table below (closest caliber and origin offset with upper value)

17.1.2. Inputs of multiplexed card voltage type

These inputs do not have any analogical offset: offsets are calculated by the software.
The real caliber is the one, whose range includes the programmed range.

CALIBER	MEASUREMENT RANGE
1 mV	-500 μ V to +500 μ V
2 mV	-1 mV to +1 mV
5 mV	-2.5 mV to +2.5 mV
10 mV	-5 mV to +5 mV
20 mV	-10 mV to +10 mV
50 mV	-25 mV to +25 mV
100 mV	-50 mV to +50 mV
200 mV	-100 mV to +100 mV
500 mV	-250 mV to +250 mV
1 V	-500 mV to +500 mV
2 V	-1 V to +1 V
5 V	-2.5 V to +2.5 V
10 V	-5 V to +5 V
20 V	-10 V to +10 V
50 V	-25 V to + 25 V

17.1.3. Input of thermocouple type

Thermocouple measurements are treated as voltage measurements.

For a given temperature measurement range, the software determines the voltage caliber the following way:

- « T » being the absolute value of max. measurable temperature, in °C
- Add 40°C to take the max. cold solder temperature into account
- Search the corresponding voltage U in the thermocouple table
- Programming the caliber, whose measurement range includes U
- For isolated channels, no offset is used

Example:

You can program a measurement range between -50 and +50°C with a J thermocouple

- max. absolute value $T = 50^{\circ}\text{C}$
- adding 40°C $T + 40 = 90^{\circ}\text{C}$
- corresponding voltage U according to the table ThJ
 $U = 4.726\text{mV}$
- Caliber: 10mV (measurement range: -5 mV to +5 mV)

17.2. Accuracy of the thermocouple measurements

The following measurement inaccuracies are given as max. Values: the typical values are 2 to 3 times weaker.

The measurement accuracy for temperature is the addition of several possible inaccuracy sources:

Pl: accuracy of linearization

Ps: accuracy of cold solder

Pm: accuracy of measurement of the equivalent voltage

The total accuracy is then: $P_t = P_l + P_s + P_m$

For the recorder:

$P_l = \pm 0.25 \text{ }^\circ\text{C}$ for all thermocouples

$P_s = \pm 1.25 \text{ }^\circ\text{C}$ for all thermocouples

$P_m = (0.1\% \text{ of the voltage caliber} + 10 \text{ } \mu\text{V})$ divided by the thermocouple slope in $\mu\text{V}/^\circ\text{C}$

Measurement accuracy: P_m

The measurement accuracy P_m depends on the voltage caliber used by the appliance (see the previous paragraph) and on the slope of the thermocouple. You will use the slope for the thermocouple at 0°C , since it varies according to the temperature; but the variation is generally of the second order for the accuracy calculation.

Slope of the thermocouples:

J	K	T	S	B
$50 \text{ } \mu\text{V}/^\circ\text{C} (@ 0^\circ\text{C})$	$40 \text{ } \mu\text{V}/^\circ\text{C} (@ 0^\circ\text{C})$	$40 \text{ } \mu\text{V}/^\circ\text{C} (@ 0^\circ\text{C})$	$10 \text{ } \mu\text{V}/^\circ\text{C} (@ 500^\circ\text{C})$	$9 \text{ } \mu\text{V}/^\circ\text{C} (@ 1000^\circ\text{C})$

E	N	C	L	
$60 \text{ } \mu\text{V}/^\circ\text{C} (@ 0^\circ\text{C})$	$26 \text{ } \mu\text{V}/^\circ\text{C} (@ 0^\circ\text{C})$	$18 \text{ } \mu\text{V}/^\circ\text{C} (@ 1000^\circ\text{C})$	$50 \text{ } \mu\text{V}/^\circ\text{C} (@ 0^\circ\text{C})$	

Example of accuracy calculation

We make a measurement between -50°C and $+50^{\circ}\text{C}$ with a J thermocouple with compensation for cold solder.

$$P_t = P_l + P_s + P_m + P_d$$

$$P_l = \pm 0.25^{\circ}\text{C} \text{ (linearization accuracy)}$$

$$P_s = \pm 1.25^{\circ}\text{C} \text{ (compensation for cold solder)}$$

Used caliber	10 mV (see the previous example)
Accuracy for voltage measurement	$0.1\% * 10 \text{ mV} + 10 \mu\text{V} = 20 \mu\text{V}$
Slope of thermocouple J	$50 \mu\text{V}/^{\circ}\text{C}$
Accuracy P_m	$P_m = 20/50 = 0.4^{\circ}\text{C}$
Total accuracy	$P_t = 0.25 + 1.25 + 0.4 = 1.9^{\circ}\text{C}$

17.3. Measurement accuracy for PT100

The following measurement inaccuracies are given as max. values: the typical values are 2 to 3 times weaker.

The measurement accuracy for temperature is the addition of several possible inaccuracy sources:

Pl: accuracy of linearization

Pz: accuracy of the zeroing

Pm: accuracy of measurement of the equivalent voltage

Pd: accuracy of the measurement offsets

The total accuracy is then: $P_t = P_l + P_z + P_m + P_d$

For the recorder:

$P_l = \pm 0.1 \text{ } ^\circ\text{C}$ for all PT100

$P_z = \pm 0.25 \text{ } ^\circ\text{C}$ for all PT100

$P_d = \pm 0.10 \%$ of the offset

$P_m =$ data in the tables

Measurement accuracy: P_m

The measurement accuracy P_m depends on the voltage caliber used for the appliance. The measurement error margin, in $^\circ\text{C}$, will be the voltage error margin divided by the slope, in $\text{V}/^\circ\text{C}$.

For all voltage calibers, the accuracy is $\pm 0.1\% \pm 10 \mu\text{V}$.

Slope as a function of temperature:

Temperature ($^\circ\text{C}$)	-200	-100	0	200	400	600	800
Slope ($\mu\text{V}/^\circ\text{C}$)	378	354	342	321	301	281	260

Measurement accuracy of the equivalent voltage at 0°C:

Temperature Caliber	Tension Caliber	max. Tension error [μV]	max. Error in °C
20	10	20	0.06
50	20	30	0.09
100	50	60	0.18
200	100	110	0.32
500	200	210	0.60
1000	500	510	1.50
2000	1000	1010	3.00

Example of accuracy calculation

We make a measurement around 240°C on the 500°C caliber centered on 0°C with a PT100 probe.

$$P_t = P_l + P_z + P_m + P_d$$

$$P_l = \pm 0.1 \text{ °C} \quad (\text{accuracy of linearization})$$

$$P_z = \pm 0.25 \text{ °C} \quad (\text{accuracy of zero})$$

$$P_d = 0 \quad (\text{no offset})$$

Calculation of P_m :

Calculation of the slope at 240°C: $321 + (301-321) \times (240-200) / (400-200)$, which means 317 $\mu\text{V}/\text{°C}$, thus $P_m = 210 / 317 = \pm 0.66 \text{ °C}$

max. total accuracy:

$$P_t = 0.1 + 0.25 + 0.66 = \pm 1.01 \text{ °C}$$

17.4. Accuracy of instant measurement according to the filters

The accuracy of instant measurement is specified with a 10 Hz filter: $\pm 0.1\%$ of full scale $\pm 10 \mu\text{V} \pm 0.1\%$ of the offsets

For higher frequency filters and for weaker calibers (high gain), the noise will be stronger (the product gain x bandwidth is constant): you have to add a noise specification. For example, you cannot get an instant accuracy of 0.1% on a 1 mV caliber without a filter.

The table below gives you the typical noise peak to peak for various calibers and filters, as a % of the caliber.

The measurements are made on a continuous voltage source « - » grounded to the source of voltage to get free from the common mode.

Caliber	1 mV	2 mV	5 mV	10 mV	20 mV	50 mV	100 mV	200 mV	>200 mV
Filter	1 kHz	1 kHz	1 kHz	10 kHz	10 kHz	10 kHz	w/o	w/o	w/o
Typical noise	3%	1.5%	0.7%	1%	0.6%	0.2%	0.6%	0.5%	0.3%

The noise is proportional to the square root of the bandwidth. To know the noise level on other filter positions, you only have to calculate the square root of the bandwidth ratio.

Example:

Noise at 10 mV with a 10 Hz filter?

Noise = 1% with a 10 kHz filter

Ratio = square root (10000/10) = 32

Thus, the noise level will be lowered by a 32 factor

Noise = 0.03% with a 10 Hz

17.5. Note on the measurement units for a gauge strain

The basis unit selected for the measurements on gauge strain is μS (micro Strain) applied to a complete bridge equipped with only one constraint-sensitive resistance.

If the bridge is equipped with 2 or 4 constraint-sensitive resistances, or if the characteristics of the bridge are given in mV/V , you can easily change of unit by using the change-of-unit function.

Fundamentally, the measurement is always a measurement of voltage.

17.5.1. Conversion rules

Complete bridge with 1 active resistance active: constraint = default measurement (μS)

Complete bridge with 2 active resistances: constraint = default measurement divided by 2 (μS)

Complete bridge with 4 active resistances: constraint = default measurement divided by 4 (μS)

Display in mV/V : use the unit change **1 mV/V \Leftrightarrow 2000 μS**

Display in V (if excitation = 2 V and $G = 2$): **1 μV \Leftrightarrow 1 μS**

17.5.2. Calculation details

- Case of the complete bridge with only one variable resistance (default case)

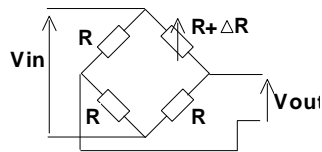

V_{in} : excitation voltage of the bridge

G : gauge factor

R : resistance of the gauge strain

V_{out} : voltage measured between the middle point of the bridge

$S = \Delta L/L$: lengthening of the gauge or constraint (strain)

For a bridge with 4 identical resistances, where one resistance changes with a variation ΔR , you can demonstrate:

$$V_{out} \approx (V_{in} / 4) * (\Delta R/R)$$

We have: $\Delta R/R = G * \Delta L/L$

$$V_{out} = (V_{in} / 4) * G * \Delta L/L \quad (1)$$

$$V_{out} = (V_{in} / 4) * G * S \quad (1)$$

In the general case $G = 2$, we get:

$$\begin{aligned} \text{for } V_{in} = 2 \text{ V} &\rightarrow V_{out} = S &\rightarrow & 1 \mu\text{V} \Leftrightarrow 1 \mu\text{S} \\ \text{for } V_{in} = 5 \text{ V} &\rightarrow V_{out} = 2.5 * S &\rightarrow & 2.5 \mu\text{V} \Leftrightarrow 1 \mu\text{S} \end{aligned}$$

- Case of the complete bridge with 2 variable resistances

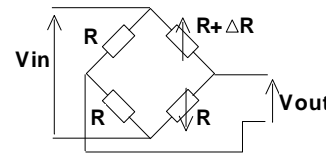

$$V_{out} = (V_{in} / 2) * G * S$$

- Case of the complete bridge with 4 variable resistances

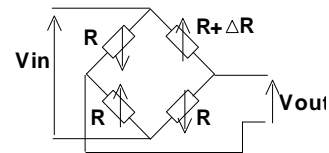

$$V_{out} = (V_{in}) * G * S$$

17.5.3. Display of the characteristics of the bridge in mV/V

For some bridges, the characteristics are given in mV/V

The equation (1) is equivalent to:

$$V_{out}/V_{in} = G * S / 4$$

For $G = 2$, we get $V_{out}/V_{in} = S/2$

Hence $1\text{mV/V} \Leftrightarrow 2000 \mu\text{S}$

17.5.4. Example of unit change

A weighting gauge strain system shows: 0.89 mV/V for 600 g

Conversion into μS ($G=2$) $\rightarrow 0.89*2000 \rightarrow 1780 \mu\text{S}$ for 600 g

Using a change of unit with the parameters:

Unit: gram

X1=0

Y1=0

X2=1780 μS

Y2=600 g

The display is now directly in grams.

17.6. Accuracy class – class index

This is a key concept of the CEI recommendation; it tends to alleviate the list of specifications.

For that, it introduces the notion of ACCURACY CLASS function of the CLASS INDEX C.

The normalized values of the class index are: C = 0.1; 0.25; 0.5 and 1.

The inherent error (in the reference conditions) should not exceed $\pm C$ % (the manufacturer can also specify the inherent error restriction as an absolute value (for example ± 5 mV) for the first calibers).

The variations (of the measured value), when an influence value varies in the nominal domain of use, will not exceed:

- C % for the position for the externally induced magnetic induction and for the parasite voltages
- 0.5 C% for the power supply source
- 0.3 C% according to the class index for the ambient temperature (0.15 % for the class 0.25).

In addition, the insensitivity range must not exceed:

- C% in the reference conditions
- 1.5C% for the maximal resistance of the external measurement circuit
- 2C% for the parasite voltages
-

At last, the overrun must not exceed 2C% (4C% for the limits of the power source).

DECLARATION OF CE CONFORMITY

according to EEC directives and NF EN 45014 norm
DECLARATION DE CONFORMITE CE
suivant directives CEE et norme NF EN 45014



SEFRAM INSTRUMENTS SAS
32, rue Edouard MARTEL
42009 SAINT-ETIENNE Cedex 2 (FRANCE)

Declares, that the below mentioned product complies with :
Déclare que le produit désigné ci-après est conforme à :

The European low voltage directive 2006/95/EEC :
La directive Européenne basse tension 2006/95/CE

NF EN 61010-1 Safety requirements for electrical equipment for measurement, control and laboratory use. Règles de sécurité
pour les appareils électriques de mesurage, de régulation et de laboratoire.

The European EMC directive 2004/108/EEC :
Emission standard EN 61326-1, EN 61326-2-1.
Immunity standard EN 61326-1, EN 61326-2-1.
La directive Européenne CEM 2004/108/CE :
En émission selon NF EN 61326-1, EN 61326-2-1.
En immunité selon NF EN 61326-1, EN 61326-2-1.

**Installation category Catégorie d'installation : jusqu'à 1000 V cat III et
600 V Cat IV en fonction du matériel choisi**

Pollution degree Degré de pollution : 2

Product name Désignation : Recorder Enregistreur

Model Type : DAS 1600- DAS 800- DAS 801- 8460

Compliance was demonstrated in listed laboratory and record in test report number
La conformité à été démontrée dans un laboratoire reconnu et enregistrée dans le rapport numéro **RC DAS 1600**

SAINT-ETIENNE the :
Thursday, 26 June 2014

Name/Position :
CLERJON / Quality Manager