



# Operation and Service Manual

---

## HYAMP® Series

Model 3240

40 Amperes AC/DC GROUND BOND TESTER

---

Serial \_\_\_\_\_

Item 40067 • Version 1.04

Printed October 12, 2021



# DECLARATION OF CONFORMITY



**Manufacturer:** Associated Research  
An Ikonix Brand

**Address:** 28105 North Keith Drive,  
Lake Forest, IL, 60045 USA

**Product Name:** HYAMP® Ground Bond Tester

**Model Number:** 3240

## Conforms to the following Standards:

**Safety:** IEC 61010-1:2010  
IEC 61010-2-030 :2010  
CAN/CSA-C22.2 NO. 61010-1-12  
CAN/CSA-C22.2 NO. 61010-2-030-12

**EMC:** EN 61326-1:2013  
EN 61000-3-3 :2013/IEC 61000-3-3 :2013  
EN 61326-1/2014  
EN 61000-3-3/2014  
EN 55011/2009A1:2010  
EN 6100-4-5/2014  
IEC 61000-4-2 :2008  
IEC 61000-4-3 :2006+A1 :2007+A2 :2010  
EN 61000-4-4 :2012/IEC 61000-4-4 :2012  
EN 61000-4-6 :2014  
EN 61000-4-8 :2010/IEC 61000-4-8 :2009  
EN 61000-4-11 :2004/IEC 61000 :4-11 :2004

## Supplementary Information

The product herewith complies with the requirements of the **Low Voltage Directive 2014/35/EU**, the **EMC Directive 2014/30/EU** and the **RoHS Directive 2015/863/EU** with respect to the following substances: Lead (Pb), Mercury (Hg), Cadmium (Cd), Hevalent chromium (CR (VI)), Polybrominated biphenyls (PBB), Polybrominated diphenyl ethers (PBDE), Deca-BDE, Bis(2-ethylhexyl) phthalate, Dibutyl phthalate, Benzyl butyl phthalate, Diisobutyl phthalate included.

**Last two digits of the year in which the CE marking was affixed: 17**

The technical file and other documentation are on file with Associated Research

Joseph Guerriero  
President / General Manager  
Associated Research  
Lake Forest, Illinois USA  
August 21, 2017

# Warranty Policy

Ikonix, certifies that the tester listed in this manual meets or exceeds published manufacturing specifications. This tester was calibrated using standards that are traceable to the National Institute of Standards and Technology (NIST).

Your new tester is warranted to be free from defects in workmanship and material for a period of (5) years from date of shipment. We aim to provide an amazing experience and quality testers that last a long time. If you're not satisfied with your tester, return it within 45 days for a full refund. Calibrate annually with us, or one of our authorized partners, and we'll extend your warranty an additional year for the service life of your tester, and at least five years after discontinuation. If it breaks during that time, we promise to fix it for free (unless abuse or excessive damage is present). When your tester reaches the end of its service life, we'll responsibly recycle it and give you a discount on a replacement. Annual calibration and inspection must be made in each successive year starting one year after the original purchase date in order to remain eligible for extended warranty coverage beyond the standard warranty period (five years).

Ikonix recommends that your tester be calibrated on a twelve-month cycle. A return material authorization (RMA) must be obtained from Ikonix. To obtain an RMA please contact our Customer Support team at 1-847-367-4077 or visit [arisafety.com](http://arisafety.com). Damages sustained as a result of improper packaging will not be honored. Transportation costs for the return of the tester for warranty service must be prepaid by the customer. Ikonix will assume the return freight costs when returning the tester to the customer. The return method will be at the discretion of Ikonix.

Except as provided, herein Ikonix USA makes no warranties to the purchaser of this tester and all other warranties, expressed or implied (including, without limitation, merchantability or fitness for a particular purpose), are hereby excluded, disclaimed and waived.

Any non-authorized modifications, tampering or physical damage will void your warranty. Elimination of any connections in the earth grounding system or bypassing any safety systems will void this warranty. This warranty does not cover accessories not of Ikonix manufacture. Parts used must be parts that are recommended by Ikonix as an acceptable specified part. Use of non-authorized parts in the repair of this tester will void the warranty.

\*5 year warranty is valid on any model purchased in 2021 or after.

## Operator Modifications

Any non-authorized modifications, tampering or physical damage will void this warranty. Elimination of any connections in the earth grounding system or bypassing any safety systems will void this warranty. This warranty does not cover accessories not of Associated Research manufacture. Parts used must be parts that are recommended by Associated Research as an acceptable specified part. Use of non-authorized parts in the repair of this instrument will void the warranty.

Associated Research will not be responsible for any injuries sustained due to unauthorized equipment modifications or use of parts not specified by Associated Research Instruments returned to Associated Research with unsafe modifications will be returned to their original operating condition at your expense.

# Table of Contents

|   |    |
|---|----|
| <a href="#">Safety Precautions and Warning Symbols for High Current Testing</a> | 5  |
| <a href="#">Front Panel Controls</a>  | 6  |
| <a href="#">Rear Panel Controls</a>   | 7  |
| <a href="#">Setup Instructions</a>  | 8  |
| <a href="#">Getting to Know Your Instrument</a>                                 | 9  |
| <a href="#">Main Menu</a>   | 11 |
| <a href="#">1. Setup System</a>   | 12 |
| <a href="#">2. Setup Tests</a>  | 33 |
| <a href="#">2.1 Setup Ground Bond Test</a>                                      | 34 |
| <a href="#">3. Perform Tests</a>  | 39 |
| <a href="#">4. Security</a>   | 45 |
| <a href="#">5. FailCHEK</a>   | 47 |
| <a href="#">6. MyMenu</a>   | 48 |
| <a href="#">Using Remote I/O and PLC Control</a>                                | 49 |
| <a href="#">Appendix A - Installation and Test Operator Information</a>         | 52 |
| <a href="#">Installation</a>  | 52 |
| <a href="#">1. Unpacking and Inspection</a>                                     | 52 |
| <a href="#">2. Safe Lifting and Carrying Instructions</a>                       | 52 |
| <a href="#">3. Contents of the Carton</a>                                       | 52 |
| <a href="#">4. Preparation for Use</a>  | 53 |
| <a href="#">5. Power Cable</a>  | 53 |
| <a href="#">Operating Environment</a>   | 54 |
| <a href="#">Storage and Shipment</a>  | 54 |
| <a href="#">Test Operator and Safety Considerations</a>                         | 54 |
| <a href="#">1. Qualifications</a>   | 54 |
| <a href="#">2. Safety Procedures</a>  | 55 |
| <a href="#">3. Dress</a>  | 55 |
| <a href="#">4. Medical Restrictions</a>   | 55 |
| <a href="#">5. Test Station</a>   | 55 |
| <a href="#">Appendix B - Instrument Specifications</a>                          | 59 |
| <a href="#">Appendix C - Series Options</a>                                     | 59 |
| <a href="#">Appendix D - Remote Bus Interface: RS-232</a>                       | 60 |
| <a href="#">Appendix E - Replacement Parts List</a>                             | 73 |
| <a href="#">Appendix F - Calibration Procedure</a>                              | 75 |

NOTE: This is an interactive PDF, if viewing on a computer click on our [quick links](#) to jump quickly to that section. Return to the Table of Contents by simply clicking on the page number with a ▲ above it in the bottom right corner.

# Safety Precautions and Warning Symbols for High Current Testing

**GENERAL:** Review this product and its related documentation for familiarization with safety markings and instructions before operation.

This product is a Safety Class I instrument (provided with a protective earth terminal). Before applying power verify that the input voltage to the instrument is 115VAC±10% or 230VAC±10% and the correct fuse is installed.



Product will be marked with this symbol when it is necessary to refer to the operation and service manual in order to prevent injury or equipment damage.

S'il vous plaît se référer au manuel d'instructions de mise en garde ou information sur la prudence pour éviter des blessures ou des dommages au produit



Product will be marked with this symbol when hazardous voltage or current may be present.

Avertissement des tensions dangereuses qui peuvent être présentes



Product will be marked with this symbol at connections that require earth grounding.

Le produit sera marqué de ce symbole au niveau des connexions qui nécessitent à la terre.

## Caution and Warning Symbols

### WARNING

Calls attention to a procedure, practice, or condition that could possibly cause bodily injury or death.

Appelle l'attention sur une procédure, une pratique ou une condition qui pourrait causer des blessures corporelles ou la mort.

### CAUTION

Calls attention to a procedure, practice, or condition that could possibly cause damage to equipment or permanent loss of data.

Appelle l'attention sur une procédure, une pratique ou une condition qui pourrait causer des blessures corporelles ou la mort.

### WARNING

The HYAMP produces voltages and currents that can cause **harmful or fatal electric shock**. To prevent accidental injury or death, these safety procedures must be strictly observed when handling and using the test instrument.

Le HYAMP, des tensions et des courants qui peuvent causer des chocs électriques dangereux ou mortel. Pour éviter toute blessure ou un décès accidentels, ces procédures de sécurité doivent être strictement respectées lors de la manipulation et l'utilisation de l'appareil de contrôle.

# Front Panel Controls

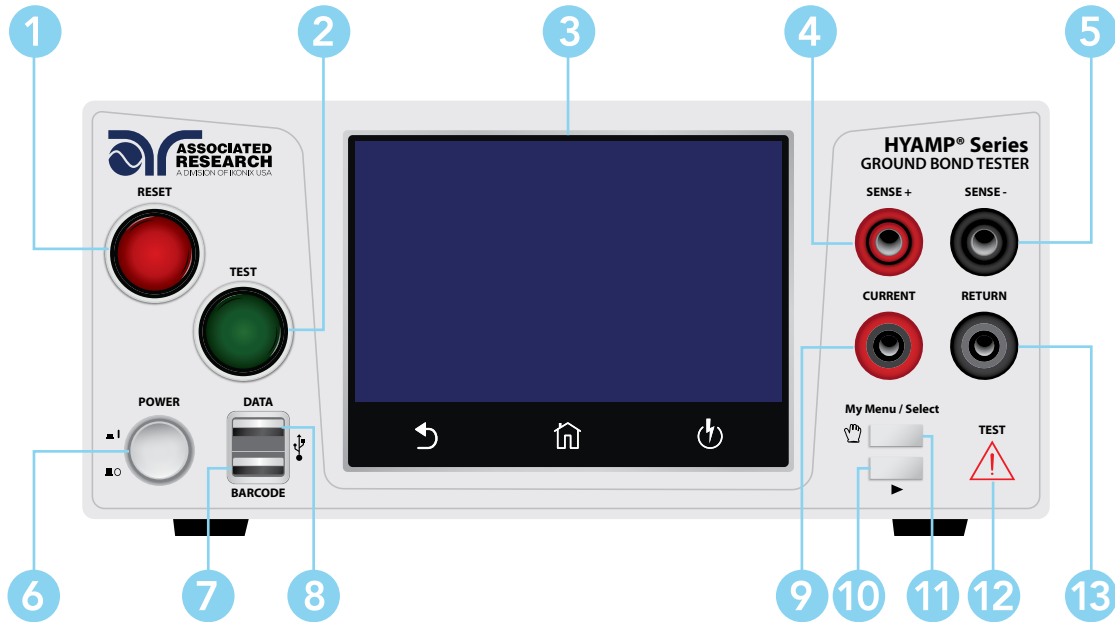

- 1 RESET BUTTON:** Resets the instrument. If a failure condition occurs during a test, pressing this button will reset the system, shut off the alarm and clear the failure condition. You must press the Reset button before performing another test or changing any of the setup parameters. This button also serves as an abort signal to stop any test in progress.
- 2 TEST BUTTON:** This is a momentary contact switch used to start a test. Press the green button to turn on the high voltage output when in test mode. The indicator lamp within the button will light when test expires with pass condition.
- 3 TOUCH SCREEN GRAPHIC LCD:** Displays all the information and allows full control of the instrument.
- 4 SENSE+ TERMINAL:** Connector used to attach the + sense lead for 4-wire Kelvin current measurement. This connection provides accurate current measurement during the Ground Bond test.
- 5 SENSE- TERMINAL:** Connector used to attach the - sense lead for 4-wire Kelvin current measurement. This connection provides accurate current measurement during the Ground Bond test.
- 6 POWER SWITCH:** Powers the test instrument ON or OFF.
- 7 BARCODE USB PORT:** This USB style port allows for connecting a barcode scanner.
- 8 DATA USB PORT:** This USB style port allows for connecting a USB flash drive to extract test and system data.
- 9 CURRENT OUTPUT TERMINAL:** Connector used to attach the high current output lead, adapter box high current lead or test fixture high current lead to the instrument. This connection provides the output current for the ground bond and continuity.
- 10 TOGGLE:** This button allows you to toggle between test files if you are wearing gloves.
- 11 MY MENU:** Brings up the MyMENU screen.
- 12 HIGH CURRENT INDICATOR:** This indicator flashes to warn the operator that high current is present at high current output terminal.
- 13 RETURN TERMINAL:** Connector used to attach the return test lead, adapter box return lead or test fixture return lead to the instrument. This connection provides the return current path.

# Rear Panel Controls

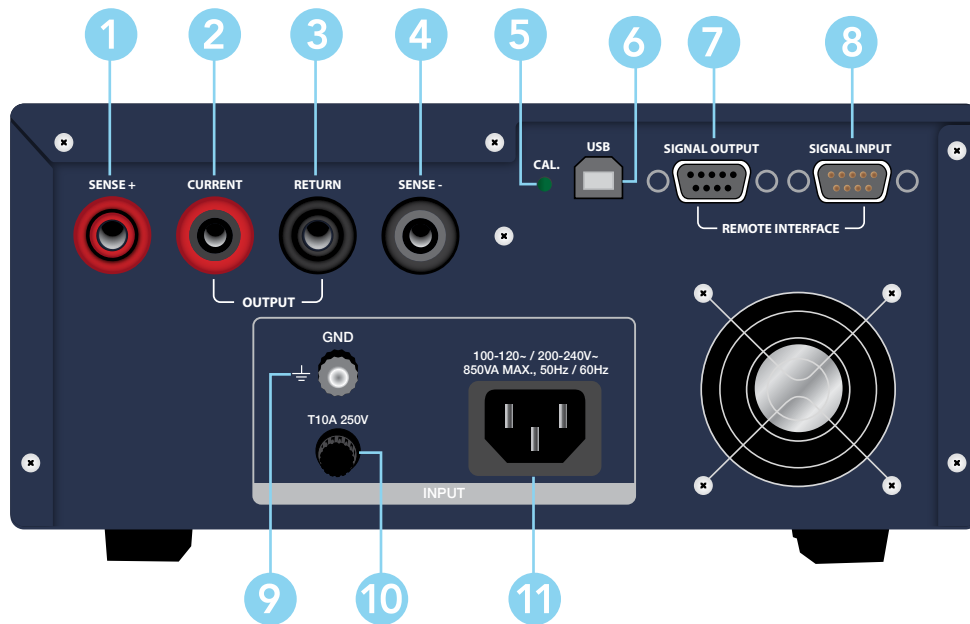

- 1 Rear Panel SENSE+ TERMINAL:** Connector used to attach the + sense lead for 4-wire Kelvin current measurement. This connection provides accurate current measurement during the Ground Bond test.
- 2 Rear Panel CURRENT OUTPUT TERMINAL:** Connector used to attach the high current output lead, adapter box high current lead or test fixture high current lead to the instrument. This connection provides the output current for the ground bond.
- 3 Rear Panel RETURN TERMINAL:** Connector used to attach the return test lead, adapter box return lead or test fixture return lead to the instrument. This connection provides the return current path.
- 4 Rear Panel Rear SENSE- TERMINAL:** Connector used to attach the - sense lead for 4-wire Kelvin current measurement. This connection provides accurate current measurement during the Ground Bond test.
- 5 CALIBRATION BUTTON:** To put the instrument into the calibration mode push this button and turn on the power switch simultaneously.
- 6 BUS INTERFACE:** Standard USB connector for interconnection to bus interface.
- 7 REMOTE SIGNAL OUTPUT:** 9-Pin D-type subminiature female connector for monitoring PASS, FAIL, and PROCESSING output relay signals.
- 8 REMOTE SIGNAL INPUT:** 9-Pin D-type subminiature male connector for remote control of TEST, RESET, and REMOTE INTERLOCK DISABLE functions, as well as MEMORY SELECTION.
- 9 CHASSIS GROUND (EARTH) CONNECTION:** For added operator safety, connect this terminal to earth ground.
- 10 FUSE RECEPTACLE:** To change the fuse, unplug the power (mains) cord and turn the fuse receptacle counter-clockwise. This will expose the fuse compartment. Always replace with properly rated fuse.
- 11 INPUT POWER RECEPTACLE:** Standard IEC 320 connector for connection to a standard NEMA style line power (mains) cord.

# Setup Instructions

## Power Up Sequence

1. Connect the power input plug into its socket on the rear panel of the instrument. Connect the male end of the plug to the outlet receptacle.

To Grounded  
Power Source



### WARNING

Only insert the main plug in a socket outlet with a protective ground (earth) contact. This protective ground must not be defeated by the use of an extension cord without a protective conductor.

La fiche principale ne doit être insérée dans une prise de courant avec une masse (terre) avec système de protection. Cette terre de protection ne doit pas être vaincu par l'utilisation d'une rallonge sans conducteur de protection.

2. Connect the Interlock Disable key to the Remote Input connector on the back panel of the instrument. This is required in order to run a test. For more information on the interlock, see section for Remote I/O.





- Turn on the POWER switch located on the lower left hand side of the front panel. Upon powering the instrument up, a POWER ON SELF TEST (POST) will automatically be performed. This test will check for the condition of the ram chips, PCB's and other critical components. The instrument screen will then default to the main menu.

The default screen is the main menu screen of the instrument. From this screen you can access all the functions and settings of the instrument:

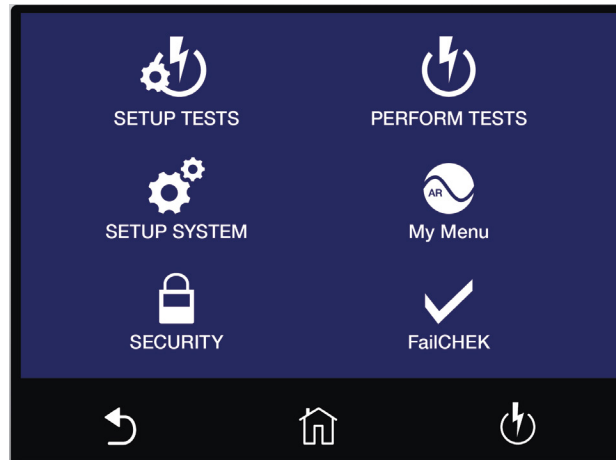

Main Menu

## Getting to Know Your Instrument

### Using the Touch Screen

The touch screen display of the HYAMP provides full control of the instrument. Use the touch screen to setup system and test parameters as well as security setup and calibration. HYAMP's touch screen functions just like any other touch screen.

### Soft Keys

The HYAMP touch screen has 3 functional keys: Back, Home and Perform Tests:

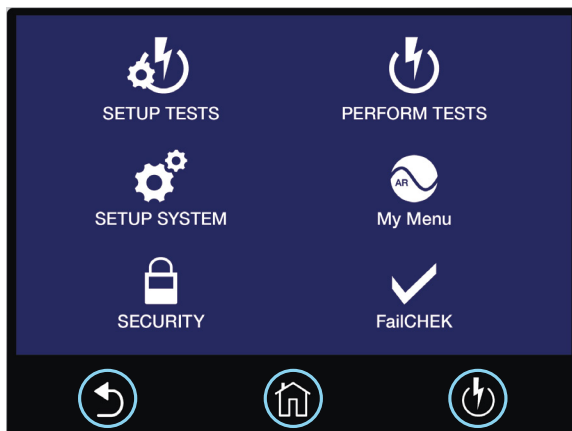

Use the **Back** key to return to a previous menu.



Use the **Home** key to return to the Main Menu.



Use the **Perform Tests** key to navigate to the Perform Tests screen.

## Touch

The various screens of the HYAMP will display icons and parameters. Touch the appropriate icon or parameter with the fingertip as shown in the image to the right.

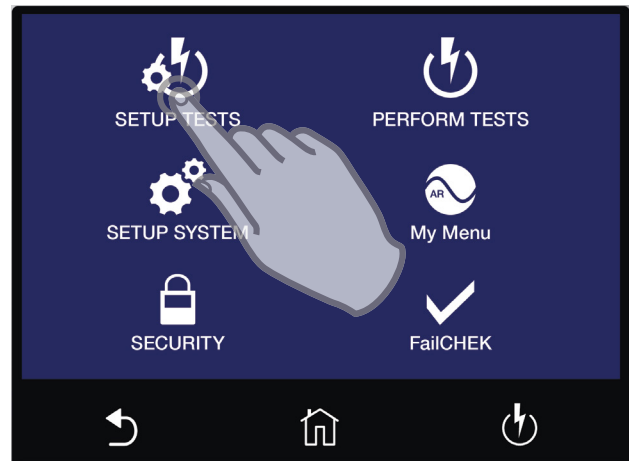

## Scroll and Swipe

A scroll bar on the right side of the screen indicates that there are additional parameters or features. To scroll up and down between parameters touch the screen anywhere scroll upward or downward. Swipe left to right in order to change parameters when setting up test or system values.

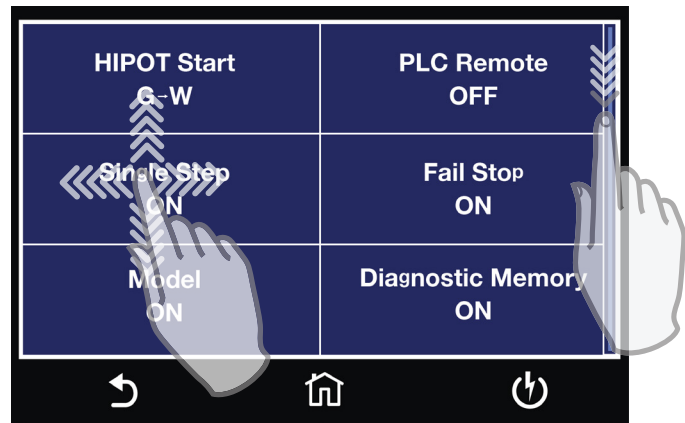

## Drag and Drop

You can drag and drop meters on your perform test screen. There are four meter locations, simply touch meter, hold, and drag to desired location.

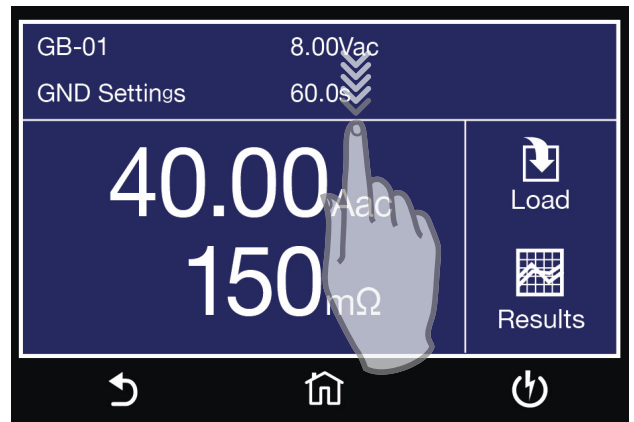

# Main Menu

Upon powering up, the instrument will default to the Main Menu. The Main Menu is also the default home screen.

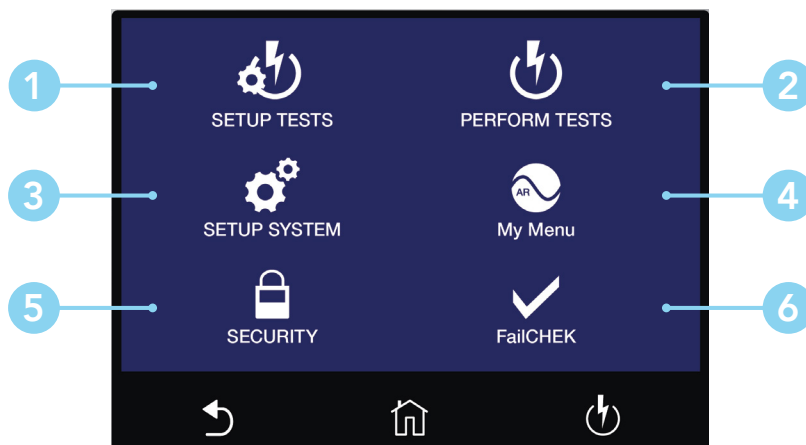

Main Menu

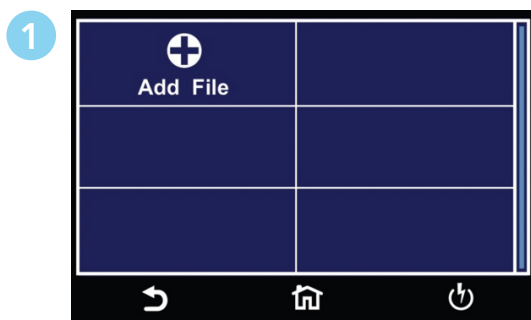

Setup Tests Screen - Create test files.

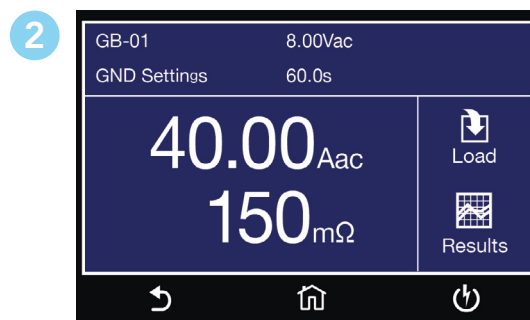

Perform Test Screen - Navigate to the Perform Tests screen in order to run a test sequence.



Setup System Menu - Instrument global parameters such as time and date, calibration and hardware.



My Menu Screen - User customized menu.

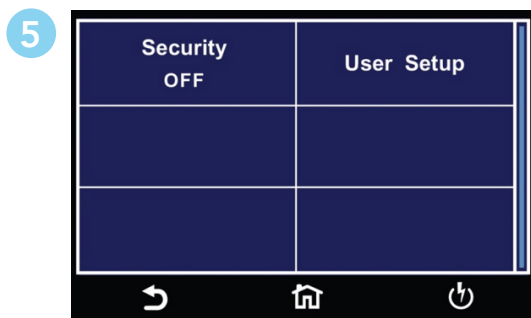

Security Menu - Access instrument lockout and security features.

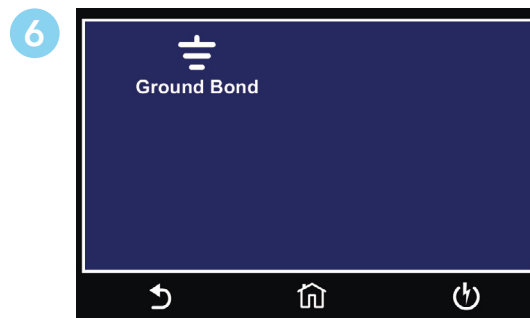

[FailCHEK](#) Menu - Check the instrument's failure detectors

**\*Note – Details of each system and test parameter are listed in the relevant sections of the manual.**

# 1. Setup System

From the default main menu touch the Setup System icon to enter the Setup System sub menu. This is where all System Parameters can be edited:

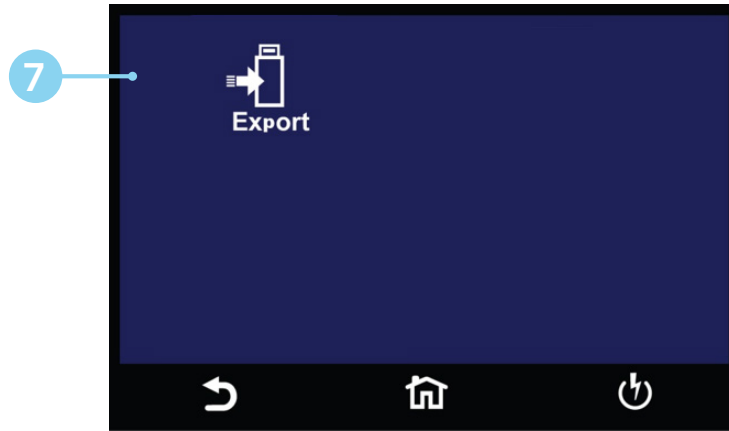
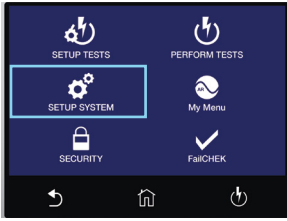

Import and Export menu's will appear when USB is detected in data port.

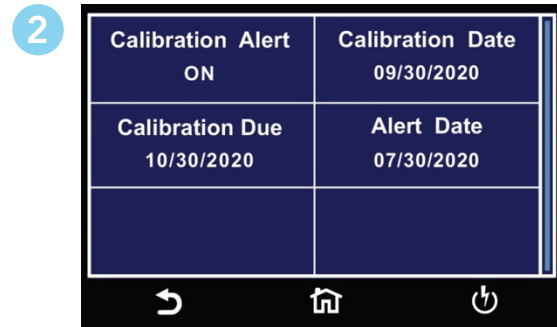

Continued on next page →

# Setup System Continued

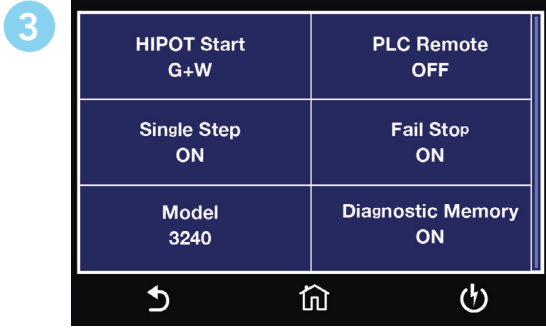

Hardware Menu



Interface Menu

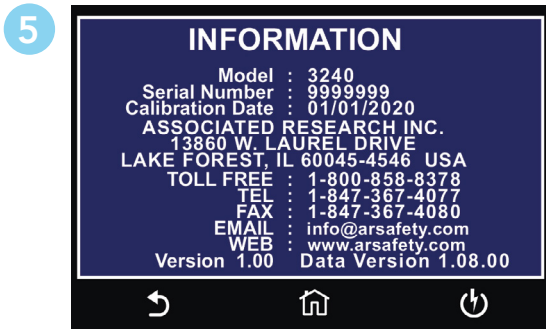

Information Screen

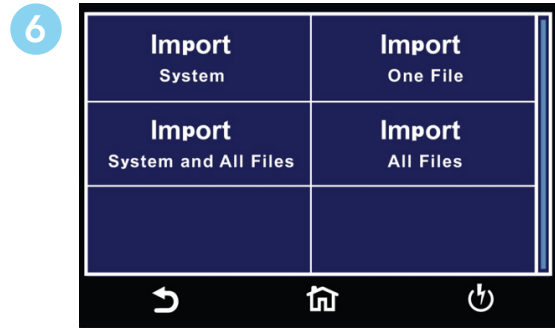

Import Menu



Export Menu

## Time and Date

Time and Date menu allows the user to edit and save the System Time and Date. This time and date will be used to stamp the test results data.

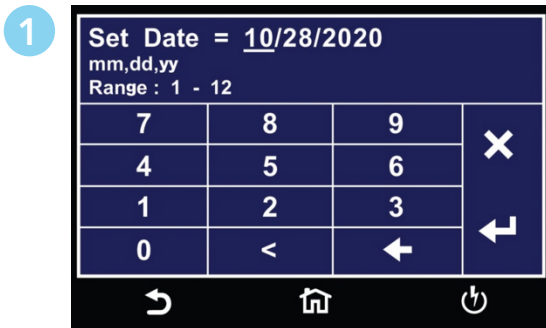

Enter the current date to set System Date.

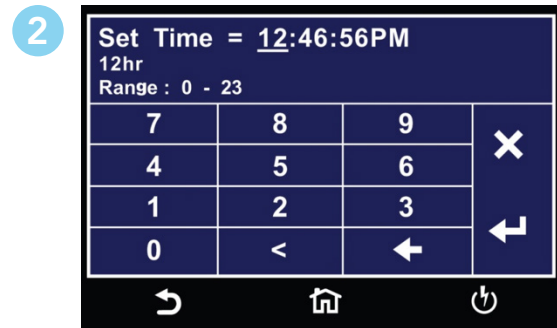

Enter current time to set System Time.

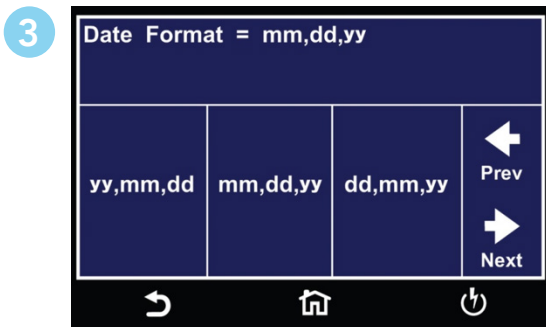

Select the Date Format for System Date.

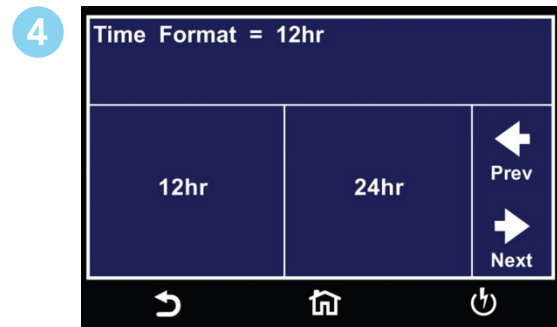

Select the Time Format for System Time.

## Calibration Alert

The Calibration Alert menu allows the user to setup alerts prior to the Calibration Due date. The user can also edit the Calibration Due date. It is not recommended that the Calibration Due date be changed once the instrument has been calibrated. Associated Research recommends annual calibrations for all models.

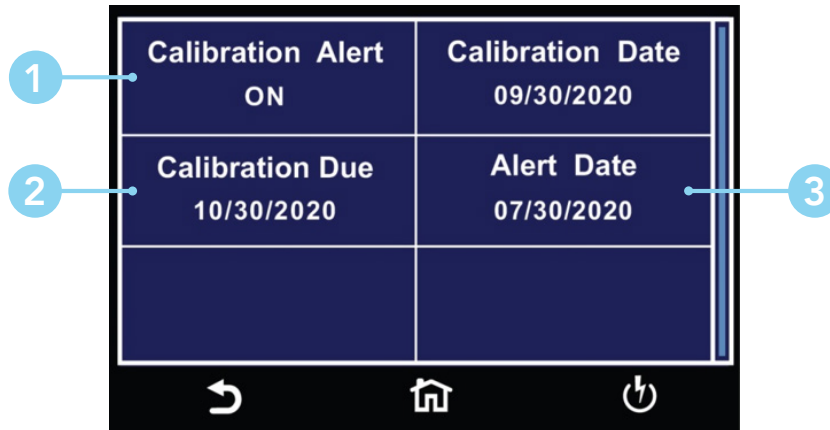
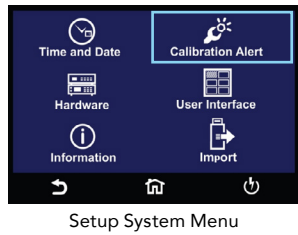

Calibration Alert Menu

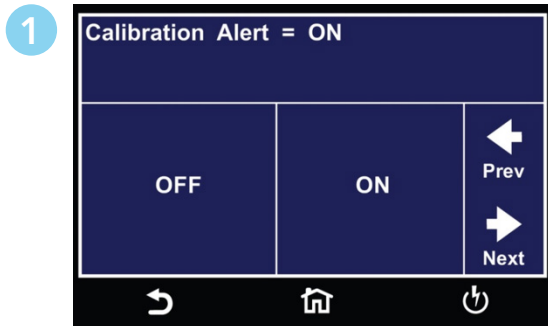

Select Calibration Alert ON or OFF.

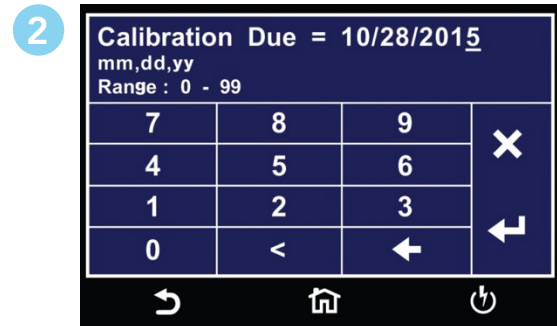

Enter a Calibration Due date.

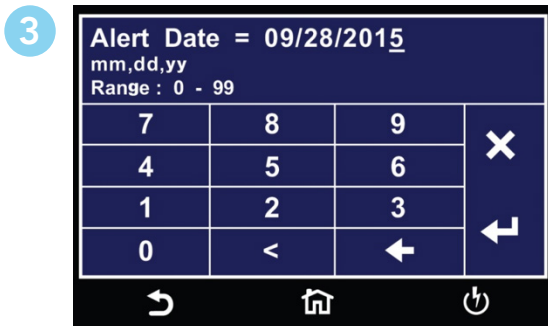

Enter a Calibration Alert Date.

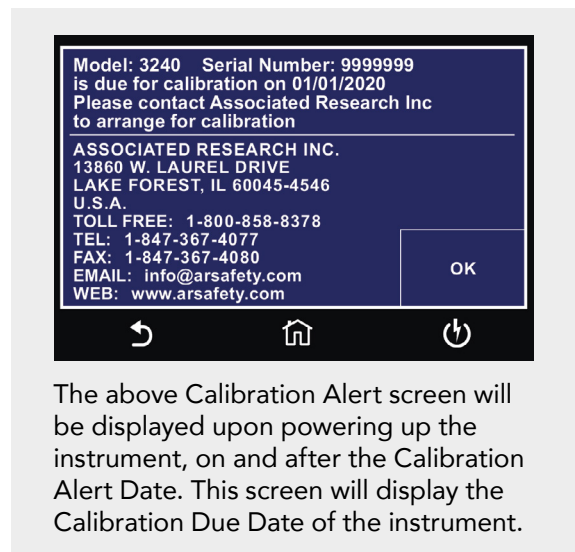

The above Calibration Alert screen will be displayed upon powering up the instrument, on and after the Calibration Alert Date. This screen will display the Calibration Due Date of the instrument.

## Information Screen

The Information screen displays all instrument information including: Model Number, Serial Number, Calibration Date, Company Information and Firmware Version.





## User Interface

The User Interface menu allows the user to edit Results, Touch Sound, Alarm Volume, Language, Home Screen, Color Style and Dual Test parameters.

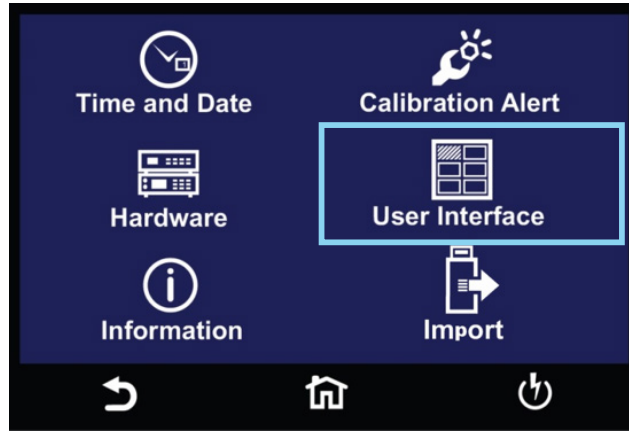

Setup System Menu



User Interface Menu

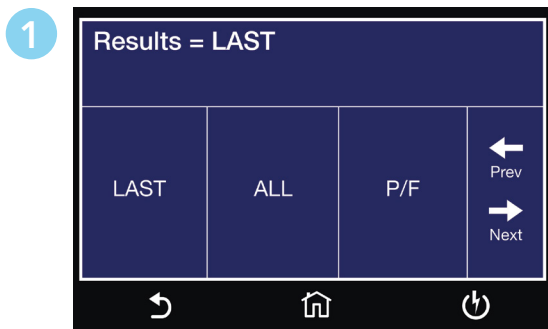

Select end of test [Result](#) Screen.

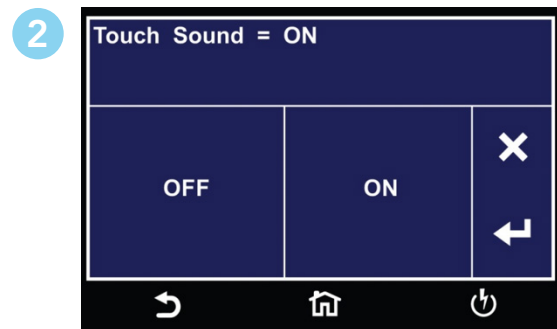

Select [Touch Sound](#) ON or OFF.

Continued on next page →

## User Interface Continued

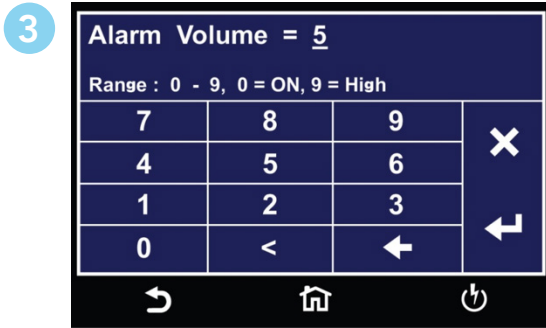

Enter Alarm [Volume level](#).



Select [System Language](#).

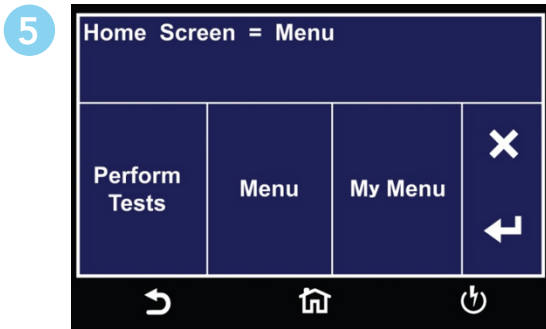

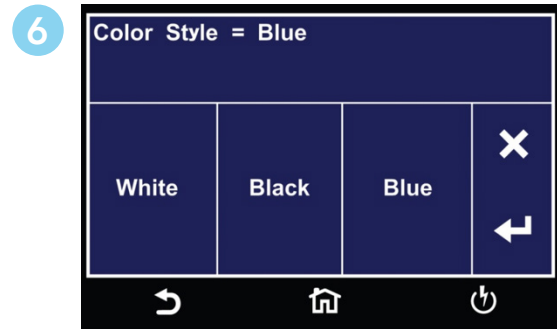

Select start up [Home Screen](#).



Select System [Color Style](#).

## User Interface Parameter Descriptions

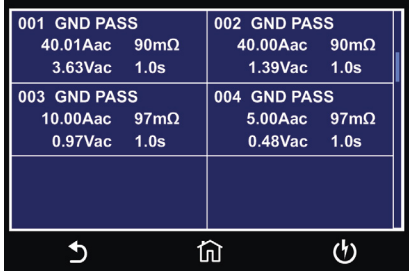
Descriptions of User Interface parameters are listed in the following table:

| RESULT       | Select how the test results will be displayed at the end of a test or test sequence.   |  |
|--------------|--|--|
| LAST         | The results of the last step performed will be displayed on the Perform Tests screen. There will not be a change in appearance or special screen displayed in this mode                              |   |
| ALL          | Results summary screen will be displayed at the end of the test or sequence of connected steps displaying the results of all of the steps.   |   |
| P/F          | Pass or Fail screen will be displayed at the end of the test.  |  |
| Touch Sound  | Set the instrument to emit a short audible beep anytime the screen is touched. Select between ON or OFF.   |  |
| Alarm Volume | Set the instrument alarm volume. The numbers corresponding to the different volume settings are 0 through 9, 0 meaning the volume is off, and 9 being the loudest setting.                           |  |
| Language     | Set the instrument display in the desired language. The available languages on the HypotULTRA instruments are English, Chinese, Simplified Chinese, German, French, Turkish, Portuguese and Spanish. |  |
| Home Screen  | Set the default screen upon instrument power up. Choose between Perform Test, Menu or My Menu.   |  |
| Color Style  | Set the color style of the touch screen.   |  |

## Import/Export

Insert USB disk into Data port and the following screen will appear. Select Import/Export to use the Import/Export menu to transfer data. Select Result Data to go to Result Data settings menu. Please refer to the Results Data section of this manual.

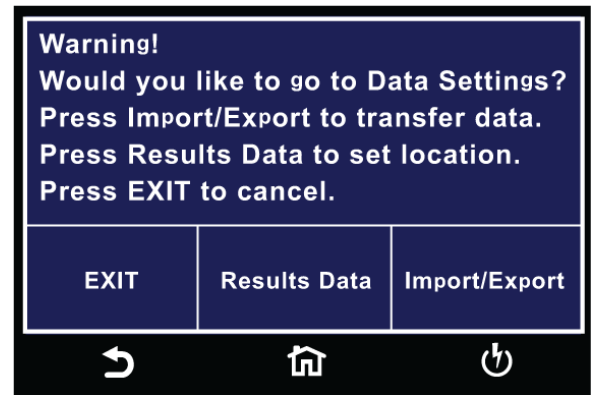

The Import/Export menu allows the user to import or export System and Test Files from a USB flash drive into the instrument memory. The Import/Export menu will only appear under the Hardware menu if a USB flash drive is inserted into the Data port on the front panel of the instrument.

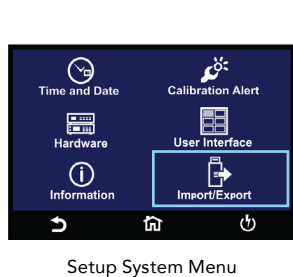

Import/Export Menu

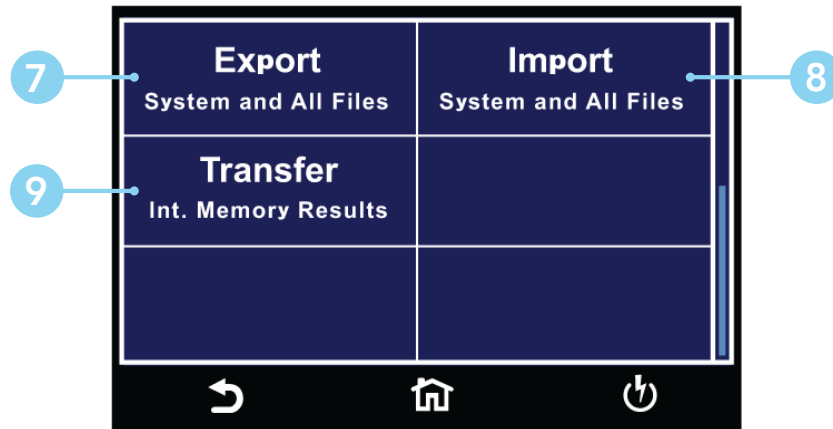

Import/Export Menu

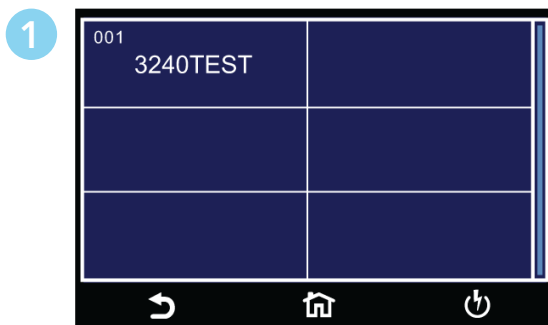

Select the Test File to export.

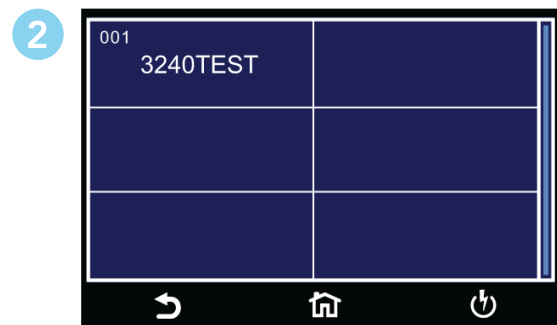

Import a single Test file.

## Import/Export Continued

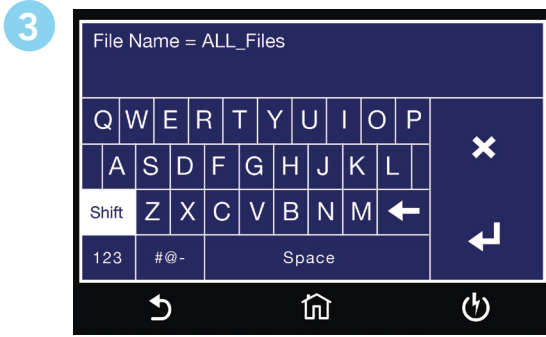

Enter file name for exporting All Files.

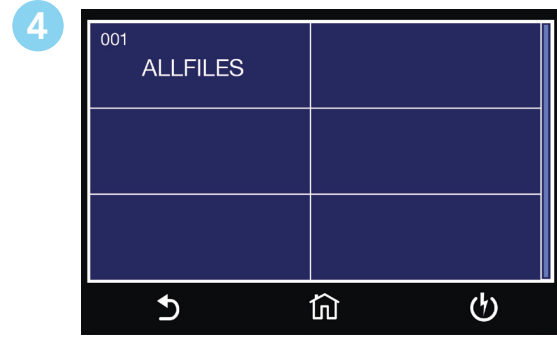

Import all Test files.

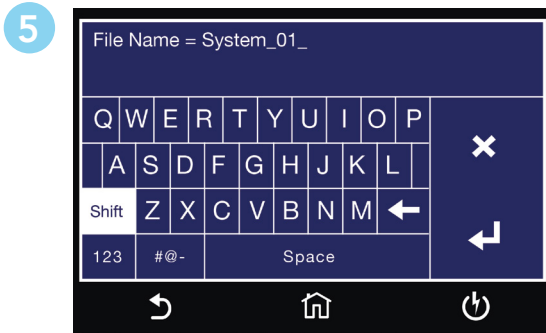

Enter file name for exporting System File.

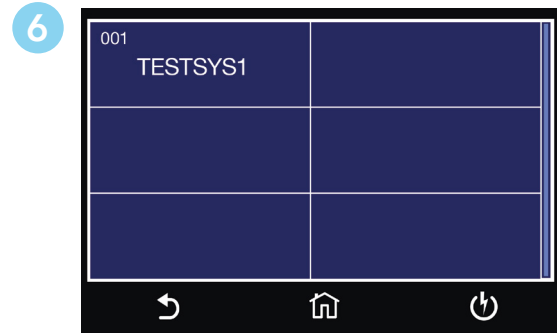

Import System file.

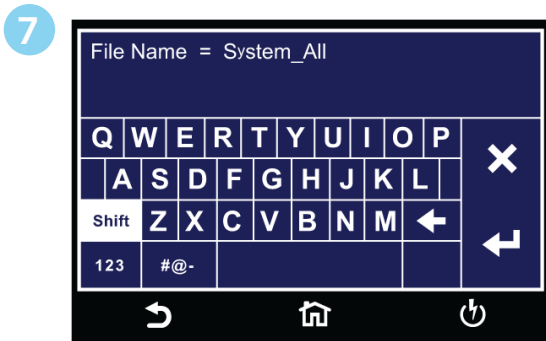

Enter file name for exporting System and All Files.

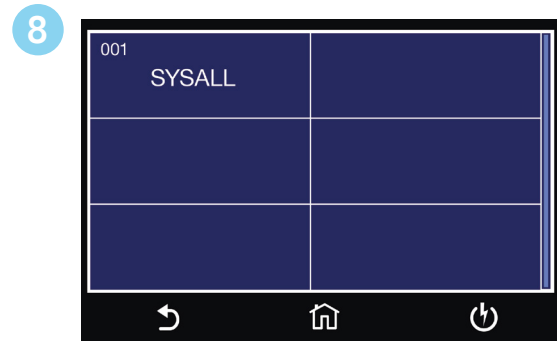

Import System and all Test files.

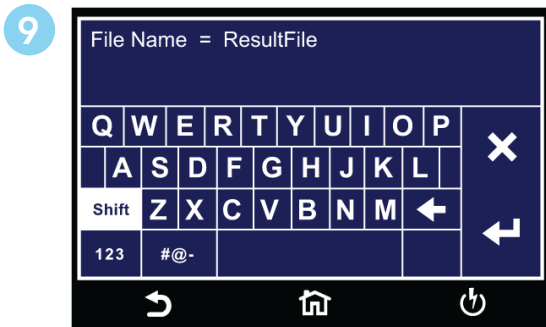

Enter file name for exporting results from internal memory.

With Result Setup Location set to Int. Memory, Transfer can be used to export result data stored on the internal memory.

# Hardware

The Hardware menu allows the user to setup hardware parameters.

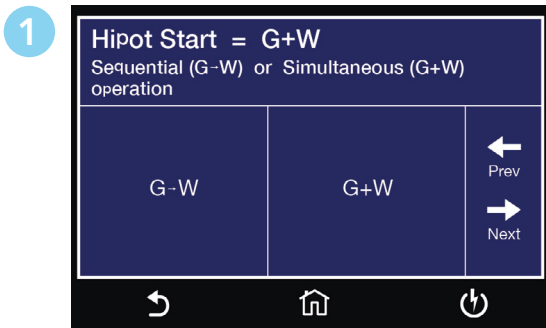
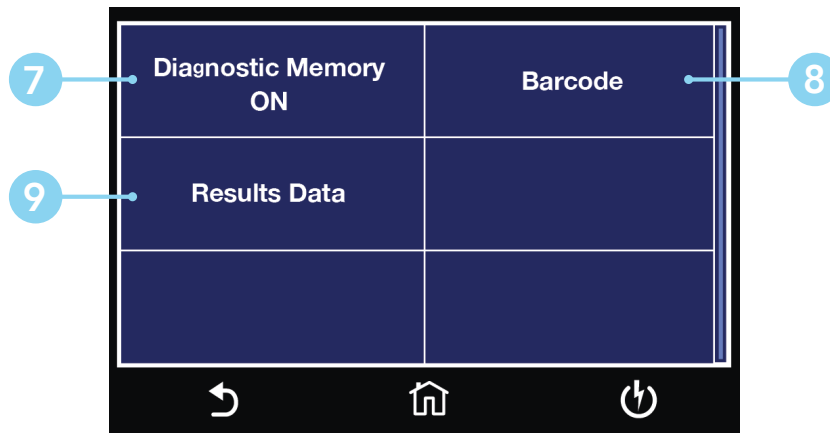
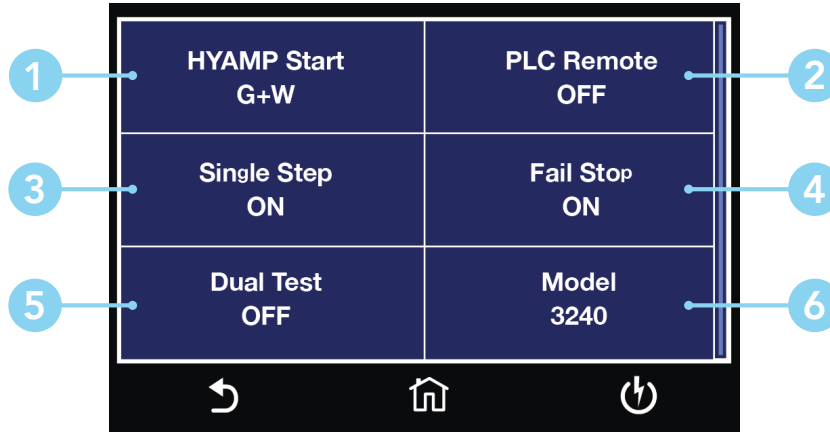
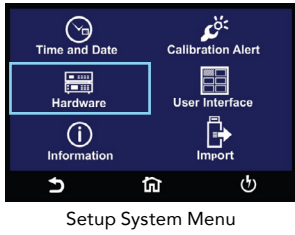

Enter **Hipot Start** value.

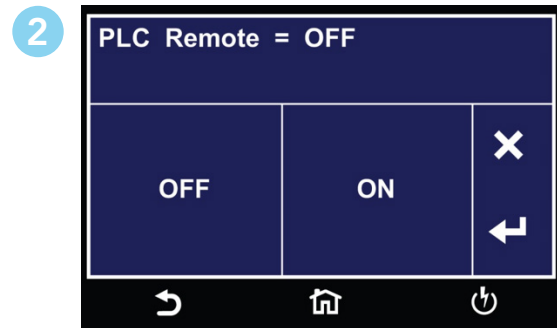

Select **PLC Remote** ON or OFF.

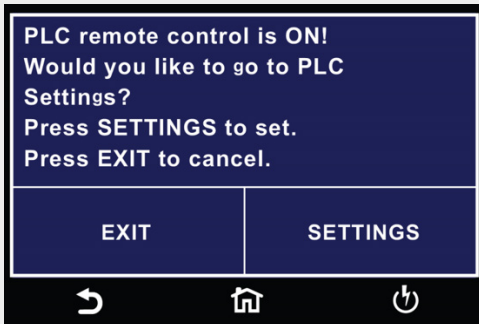

This screen comes up when pressing TEST button while PLC is ON warning customer to adjust PLC setting if need to use the TEST button.

Continued on next page →

## Hardware Continued

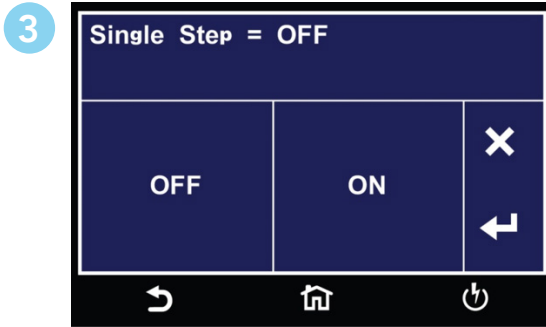

Select [Single Step](#) ON or OFF.

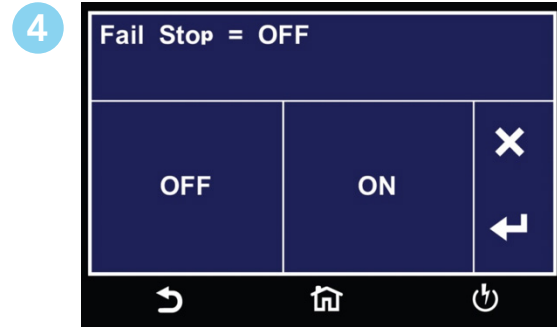

Select [Fail Stop](#) ON or OFF.



Select [Model](#).

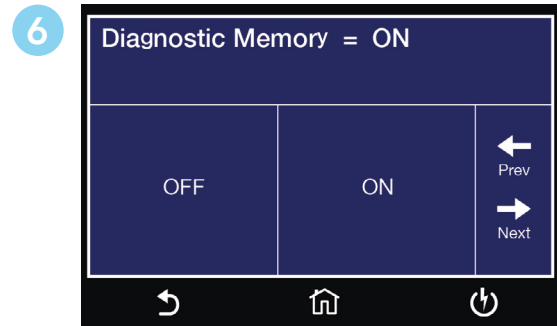

Select [Diagnostic Memory](#).

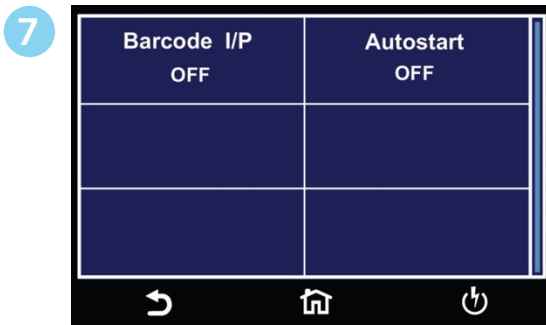

[Barcode](#) Menu.

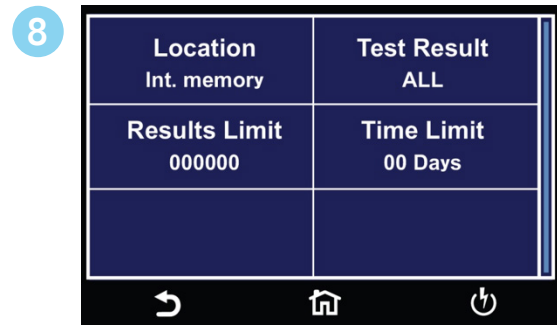

[Results](#) Setup Menu.

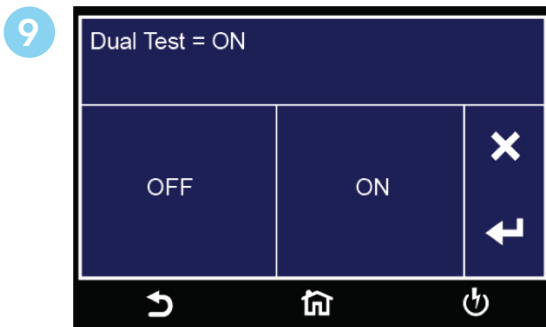

Select [Dual Test](#) ON or OFF for Dual Remote Palm Switches.

## Hardware Interconnection

### Interconnection of HYAMP® Series to Hypot® Series

You can interconnect a HYAMP® to all Hypot® models to form a complete test system.

- Using the rear panel connections, connect the following cord:
  - P/N HS-8-11 - Plug one end into the rear Sense (-) terminal on the HYAMP® Ground Bond tester. Plug the other end into the Return terminal on the rear panel of the Hypot®.
  - P/N 39932 - Plug the blue coded end into the HYAMP Signal Input. Plug the red coded end into Hipot Signal Output.
  - P/N 39933 - Plug the blue coded end into the HYAMP Signal Output. Plug the red coded end into the Hipot Signal Input.

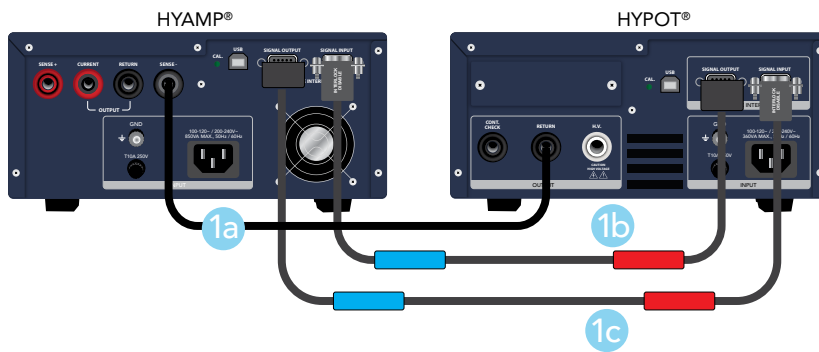

Note: Once interconnected, Hypot will disable the auto configure system settings by turning PLC on. Disconnecting the cables disables the PLC remote.

### Connection To A Device Under Test

- P/N 38490 - Plug the black return test lead into the front panel Return terminal on the HYAMP®.
- Clip the end of the test lead to chassis ground of the DUT.
- P/N 38482 - Plug the red high current lead of the adapter box into the front panel Current terminal on the HYAMP®.
- Plug the white Alden plug into the front panel High Voltage terminal on the Hipot tester.

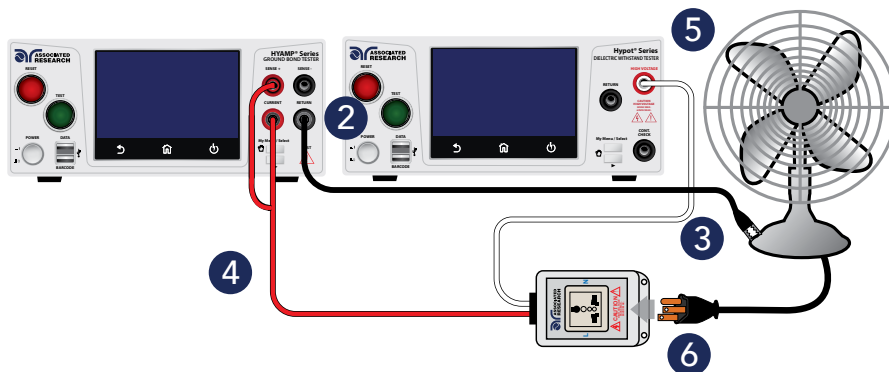

- Plug the DUT line cord into the adapter box.
- Once the test parameters are set, start the test from the HYAMP®.
- If the Ground Bond test passes, the Hipot test will automatically start. If a test fails, the test sequence will abort and failure results are displayed.



## Hardware Parameter Descriptions

Descriptions of Hardware parameters are listed in the following table:

| System Parameter                       | Setting            | Description  |
|--|--------------------|--|
| <b>Hipot Start (interconnectivity)</b> | G+W/G->W           | Connect a HYAMP and a Hypot to form a complete test system. The test system can be configured to perform sequential Ground Bond and Dielectric Withstand tests, or run both simultaneously.  |
| <b>PLC Remote</b>                      | ON/OFF             | Allows the user to initiate a test through the REMOTE INPUT on the rear panel of the instrument. If PLC Remote = ON the front panel TEST button is disabled and a test may only be started through the rear panel Remote I/O. If PLC Remote = OFF, the test must be initiated via the front panel TEST button.   |
| <b>Single Step</b>                     | ON/OFF             | Temporarily overrides the automatic connection feature. If Single Step = ON the instrument will pause after each step is completed, even if step Connect function is set to ON. To continue the test sequence, press the TEST button to execute the next connected step. Each time the TEST button is pressed the next connected step will execute. If you press the RESET button before completing all connected steps, it will return the instrument to the original starting step. If a step fails and you wish to continue to the next step, do not press the RESET button but press the TEST button.  |
| <b>Fail Stop</b>                       | ON/OFF             | If Fail Stop = ON, a sequence of tests will stop if a failure occurs. If Fail Stop = OFF, the sequence of tests will continue to the end of the sequence regardless of whether or not a failure has occurred. If a failure has occurred, the red RESET button will light and alarm will sound indicating failure during the sequence. Pressing the RESET button will silence the alarm and reset the instrument.   |
| <b>Dual Test</b>                       | ON/OFF             | The Dual Remote Test Switch option allows you to configure dual palm switches for safe production line operation. Both PLC Remote and Dual Test must be ON in order for dual remote test switch operation below to work.<br>The rear panel remote interface is reconfigured to allow two test switches instead of the standard reset and test inputs. The two test switches have to be pressed within 0.5 seconds to activate the test process. The two test switches must remain closed to continue the test. If either of the test switches is released, the process will be shut down immediately. The functions of the Test and Reset switches on the front panel will be disabled if the dual test switches are enabled. When the Dual Test parameter is turned OFF, the Test and Reset switches on the front and rear panel behave the same as the standard instrument, and are controlled by the PLC Remote On/Off selection. |
| <b>Model (HA3 Mode Option 14)</b>      | 3240/3130/<br>3145 | HA3 mode allows activation of bus command mimic mode for HYAMP III models 3130 and 3145. The new interface commands and structure of the HYAMP 3240 can emulate those of the HYAMP III interface. This will allow HYAMP III users to integrate the new model into existing test systems easier. For a complete list of bus commands for this option refer to the HYAMP III product manual.   |
| <b>Diagnostic Memory</b>               | ON/OFF             | The Diagnostic Memory is a feature that keeps snap-shot records of the tests that the instrument performs. It has a limited capacity to record basic information from test results (up to 4000 results), as well as a capacity to keep running totals for the instrument; number of GB tests performed, number of GB tests passed, total amount of time the instrument is outputting current, etc. These numbers are used by our marketing team to get a rudimentary idea of how our customers are using the instruments as well as help us troubleshoot any possible issues if the instrument comes back for repairs. This is a user-selectable feature and can be enabled or disabled from the Hardware Menu of the instrument.  |

The table below shows a full list of information that will be recorded if the Diagnostic Memory is enabled:

| Information Recorded  | Description                                     |
|-----------------------|---|
| <b>Running Totals</b> | Total time duration the output is ON            |
|                       | Total time duration the instrument is ON        |
|                       | Total number (summation) of all tests performed |
|                       | Total number of GB tests performed              |
|                       | Total number of GB Pass                         |
|                       | Number of times FailChek is used                |
| <b>Test Results</b>   | Number  |
|                       | Date  |
|                       | Time  |
|                       | Output Mode (AC/DC)                             |
|                       | Status (PASS/FAIL/ABORT)                        |
|                       | Current   |
|                       | Resistance                                      |
|                       | Voltage   |
|                       | Dwell Time                                      |
| Frequency             |   |
| <b>Settings</b>       | Color Style is selected                         |
|                       | Home Screen configuration                       |
|                       | PLC Remote (Yes/No)                             |
|                       | Single Step (Yes/No)                            |
|                       | Fail Stop: (Yes/No)                             |
|                       | Remote Bus Active (Yes/No)                      |
|                       | Prompt (Yes/No)                                 |
|                       | Number of test files created/used               |
| Language              |   |

HYAMP® comes from the factory with the following system presets:

| System Parameters |             |      |
|-------------------|-------------|------|
| Setup Sys.        | PLC Remote  | OFF  |
|                   | Single Step | OFF  |
|                   | Fail Stop   | ON   |
|                   | Alarm       | 5    |
|                   | Results     | Last |
|                   | Results     | Last |
|                   | Cal Alert   | ON   |
|                   | Security    | OFF  |

## WARNING

Initializing the instrument will overwrite all memories and steps with GND default parameters!

Initialisation de l'instrument va écraser toutes les mémoires et les étapes avec les paramètres par défaut GND!

## Barcode

### Barcode I/P

The Barcode function allows you to connect a barcode scanner directly to the front panel of the instrument's barcode port. This is utilized to enter product and serial number information for testing.

To use this function, plug a USB type barcode reader into the barcode port on the front panel of the instrument. Once a USB barcode is plugged in, the instrument will notify you that a reader has been detected:

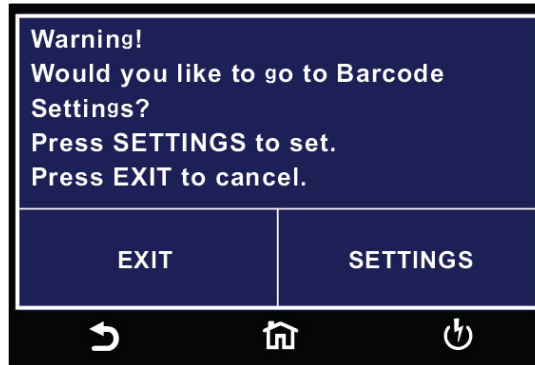

If there is a problem with the connection to the barcode reader or an incompatible device is plugged into the USB barcode port, the following message will appear:

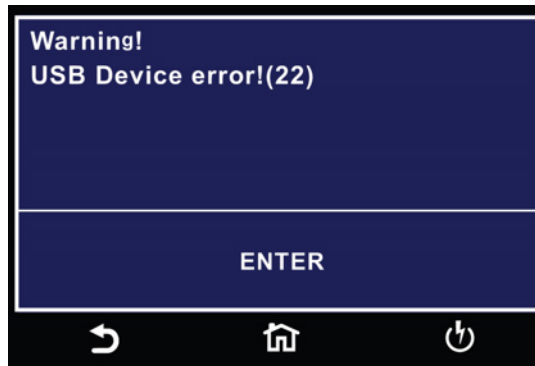

If the USB barcode device is removed while the instrument is powered on, the following message will appear:

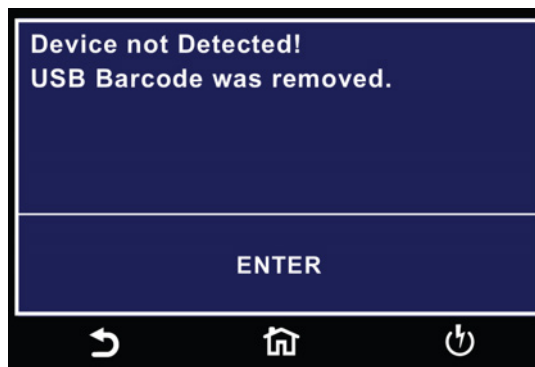

There are two options under Barcode, Barcode I/P and Autostart.

You can set the Barcode I/P function to OFF, SER/PROD, SERIAL #, PRODUCT # or RUN FILE.

When the setting is SERIAL#, PRODUCT# or SER/PROD you can scan barcodes in the Perform Tests screen before the test is started.

After the barcodes are scanned, pressing TEST will initiate the test sequence. Pressing RESET will abort the TEST sequence. The barcode function allows for the re-scanning of barcodes if the previously scanned barcode was incorrect. Re-scanning is available in the SERIAL#, PRODUCT# and SER/PROD modes. Any time before a test is initiated; you can re-scan a barcode. If you decide to re-scan barcodes when the Barcode I/P setting is set to SER/PROD, the barcode function will first replace the data in the Serial Number field, and if you re-scan another barcode, the barcode function will replace the data in the Product Number field.

The RUN FILE selection gives you the ability to automatically load a test file based on what barcode is scanned from the Perform Tests screen.

To completely enable this feature, you must name the desired test file for a particular product the exact alpha-numeric code that is on the product's barcode label. For example, if Product A has barcode "123456789", then the test file that you would like to run when testing Product A must be named "123456789". Upon scanning the barcode, the HypotULTRA will immediately load the test associated with that barcode. The test file name is limited to 10 characters. However, if you name a test file with the maximum 10 characters, this function will still initiate a test when a product's barcode begins with those first 10 characters, even if the barcode has more than 10 characters.

When using certain features of barcoding, the instrument's response to the TD? and RD x? commands will differ slightly to an instrument that is not utilizing this function. For both types of tests (AC GB/DC GB) two fields are added to the end of the standard response when the Barcode I/P setting is set to SERIAL#, a GB test could be: PRODUCT# or SER/PROD.

The first field contains the Serial Number information and the second field includes the Product Number information. Both fields are included regardless of which of these three modes are selected. The HYAMP will simply substitute a "0" for the field if it is not applicable to the setting. For example, if a user had their Barcode I/P setting set to SERIAL#, and scanned a Serial Number with the value "123456789", the TD? response for a GB test could be:

```
01,AC,PASS,25.00,1,0.05,1.0,0123456789,0
```

Note that there is a "0" in the Product Number field because the Barcode I/P setting is SERIAL#. When the Barcode I/P setting is RUN FILE or OFF, these fields are not included in the TD? and RD x? responses.

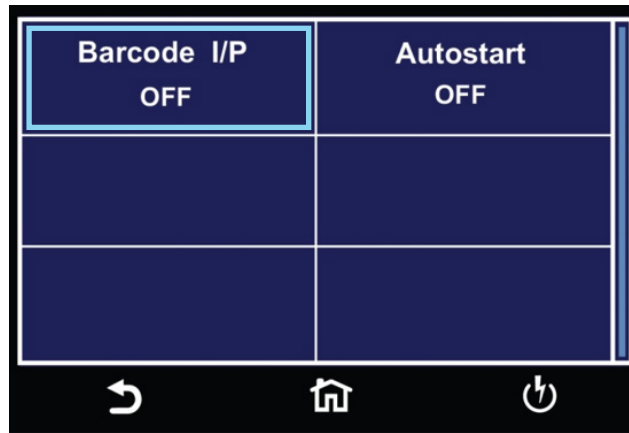

Barcode Menu

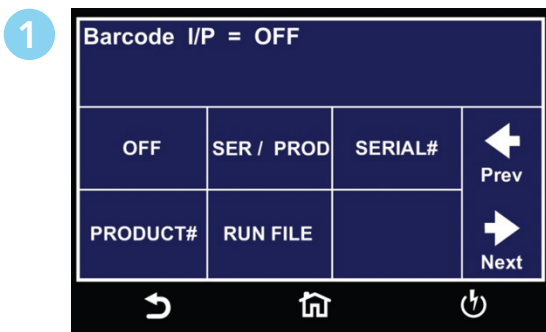

Select Barcode input option.

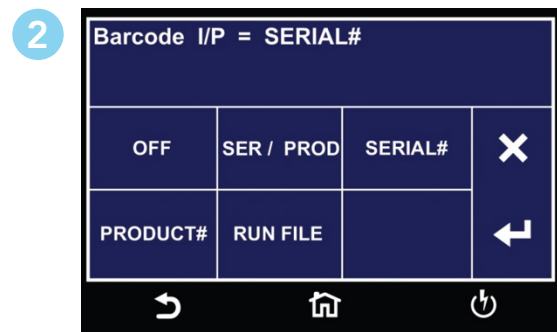

Select Barcode type.

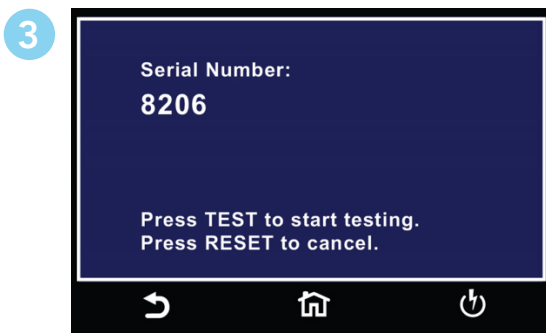

Example SERIAL # screen.

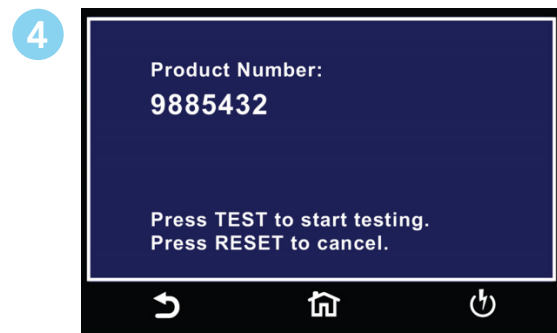

Example PRODUCT # screen.

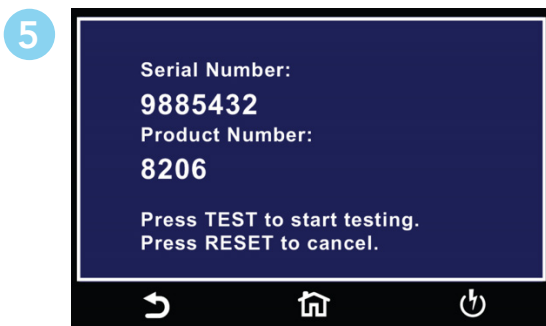

Example SER/PROD screen.

## Barcode Autostart

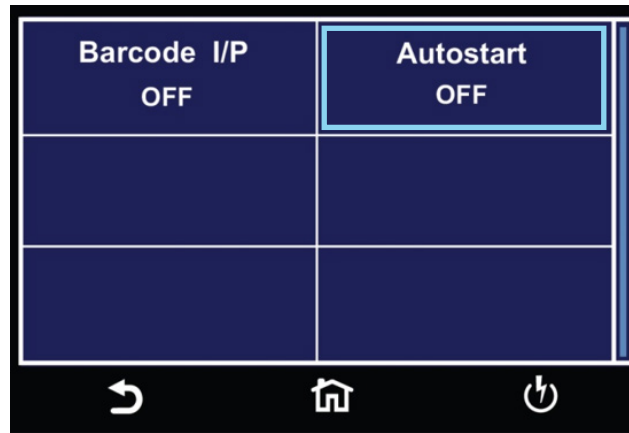

Barcode Menu

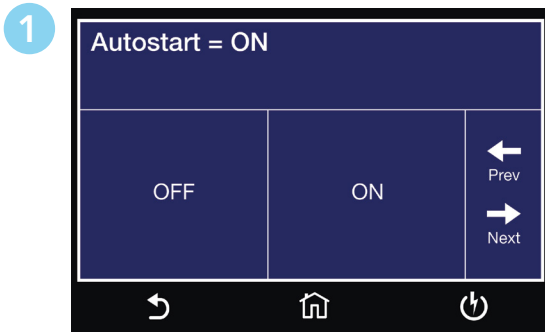

Select Autostart ON or OFF.

## Results Setup

Select Int. memory if you wish to store the test results on the onboard instrument memory. Select USB disk if you wish to save the test results on an external USB flash drive. For best results use the USB flash drive provided by Associated Research.

Select PASS to save the results of the steps that passed. Select FAIL to save the results of the steps that failed. Select ALL to save all the test results. Selecting NONE will not save any results to the internal memory.

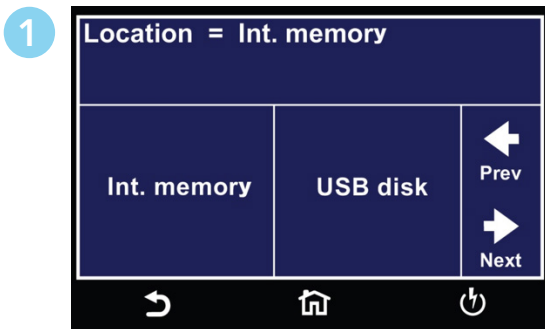
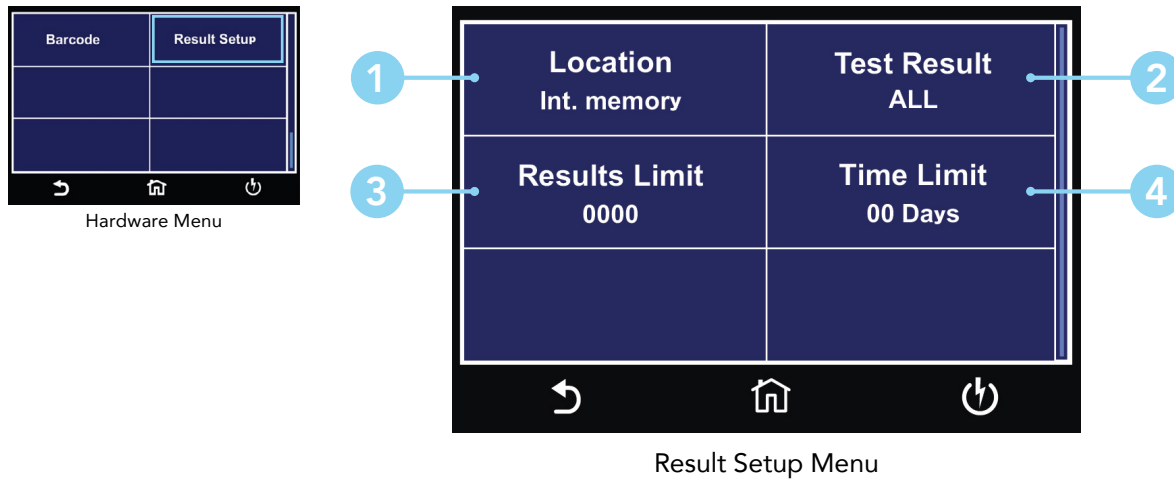

Select Location for Result Data.  
If USB disk is selected "results limit" parameter will disappear. This limit is dependent on USB storage capability.

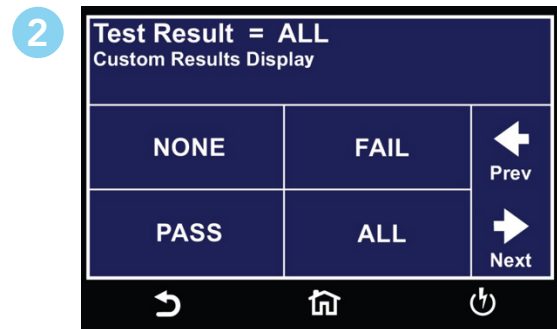

Select type of Test Results to be saved.

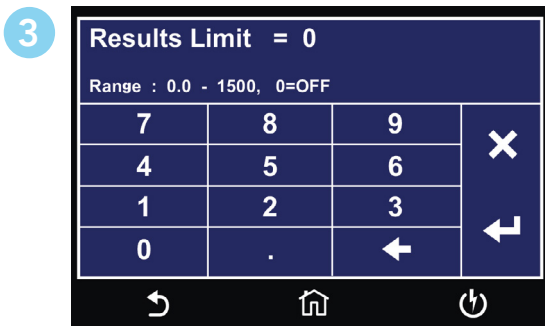

Enter Results Limit.

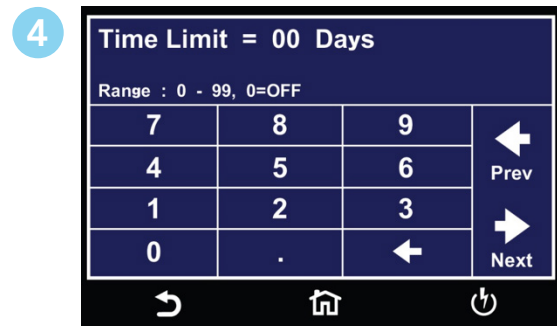

Enter Time Limit.

You can set the Results Limit. Select from 0 up to 1500 with 0 being OFF. Selecting 0 will set the Results limit to OFF which means you can store as many results as desired until you reach the maximum capability of 1500 results.



## Internal Memory

Insert USB disk into Data port and the following screen will appear. Select Result Data to go to Result Data settings menu. Select Import/Export to use the Import/Export menu to transfer data. Please refer to the Import/Export section of this manual.

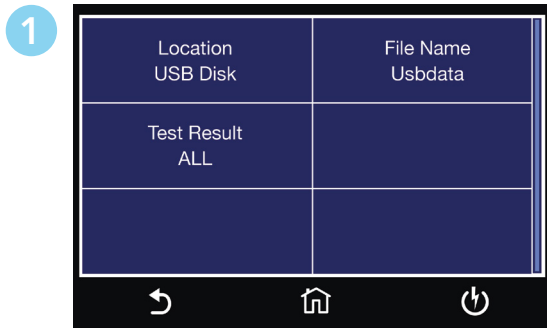
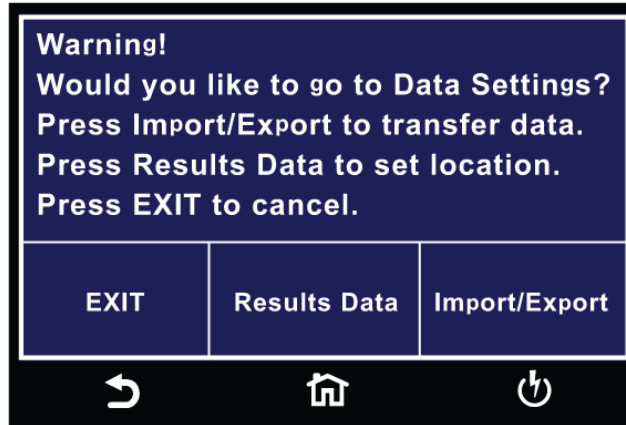

Result Setup USB DISK Menu.

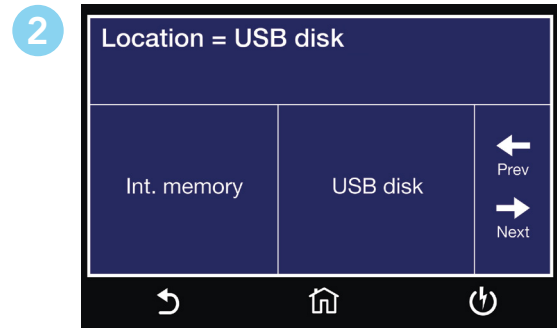

Select Location for Result Data.



Enter File Name.

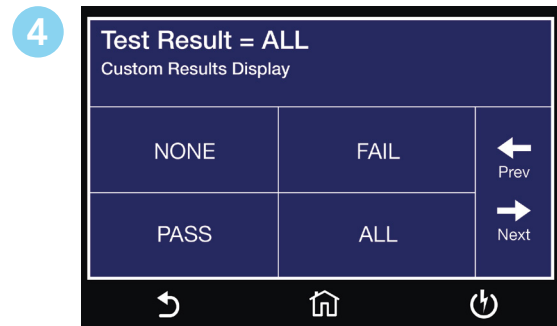

Select type of Test Results to be saved.

## 2. Setup Tests

The following sequence describes the steps necessary to create a test file, program the test parameters and save the test file:



### TAP SETUP TESTS

Home Screen

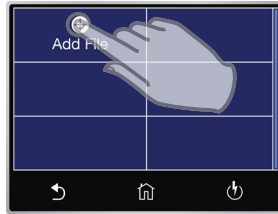

### TAP ADD FILE

File Screen



### ADD FILE NAME

Tap the ENTER (↵) key to save your selection

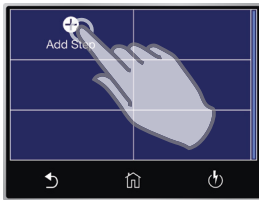

### TAP ADD STEP

Add Step

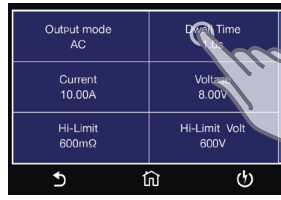

### TAP TEST SETTING

Tap the test parameter you would like to edit. Swipe up and down to scroll through test parameters.

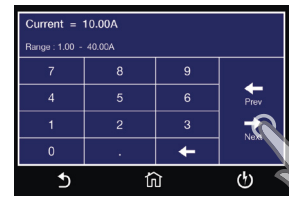

### EDIT PARAMETERS

Tap parameter values to edit individually. After you adjust each parameter, tap ENTER (↵) arrow key to save changes.

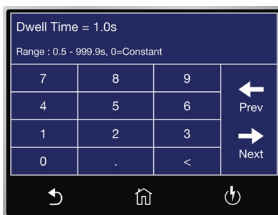

### ADJUST PARAMETERS

Scroll through each parameter to adjust values based on your application.

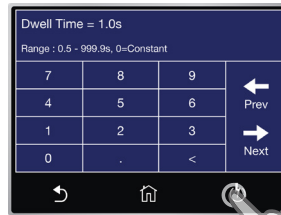

### EXIT PARAMETERS

Press the Test Screen button to exit out of Parameters.

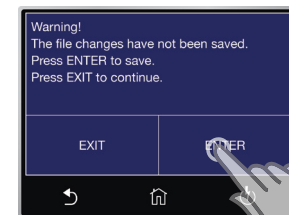

### SAVE FILE CHANGES

Press ENTER to save your file changes. You will be redirected to the Test Screen.

## 2.1 Setup Ground Bond Test

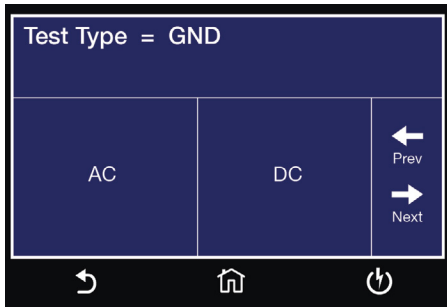

Select GND Test type.

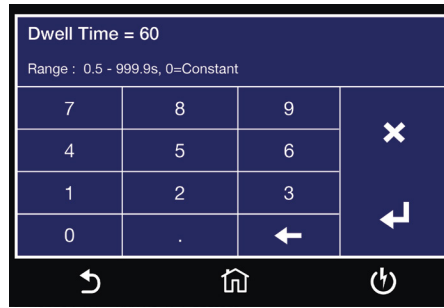

Enter test **Dwell Time**.

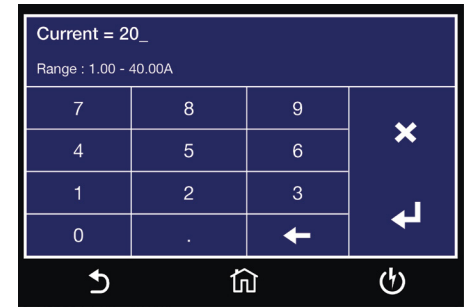

Enter test **Current** value.

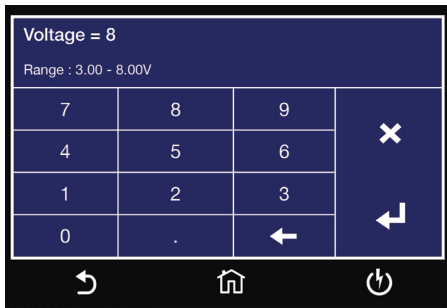

Enter test **Voltage** value.

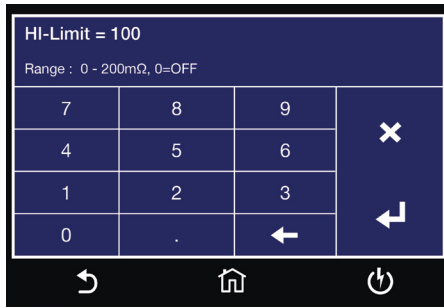

Enter **HI-Limit** for resistance.

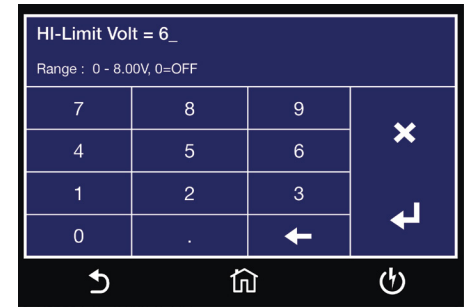

Enter **HI-Limit** for Voltage.



Enter **LO-Limit** for resistance.

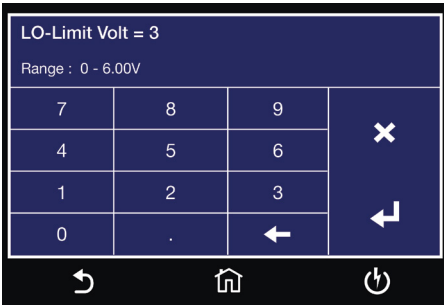

Enter **LO-Limit** for Voltage.

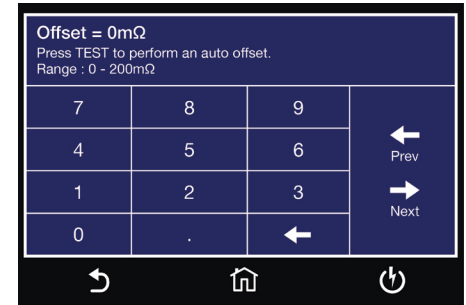

Enter **Offset** value to manually set Offset or Press TEST to perform auto offset.

Continued on next page →

## Setup Ground Bond Test Continued

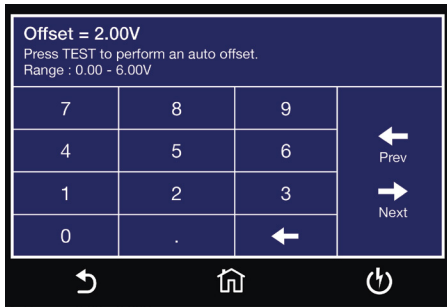

Enter **Offset** value to manually set Offset or Press TEST to perform auto offset.

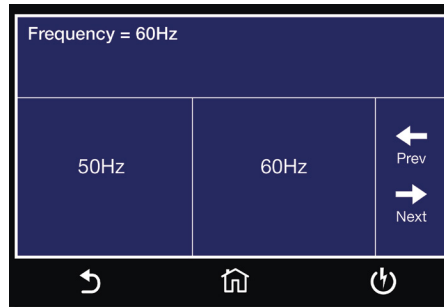

Select test **Frequency**.



Enter text for **Prompt**.

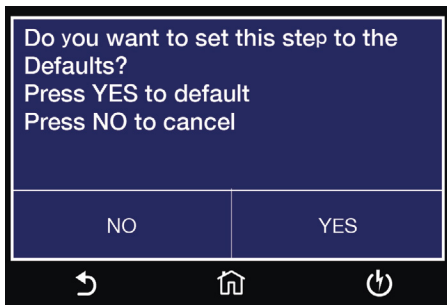

Last option is defaults which will load GND parameters.

## Offset Connections

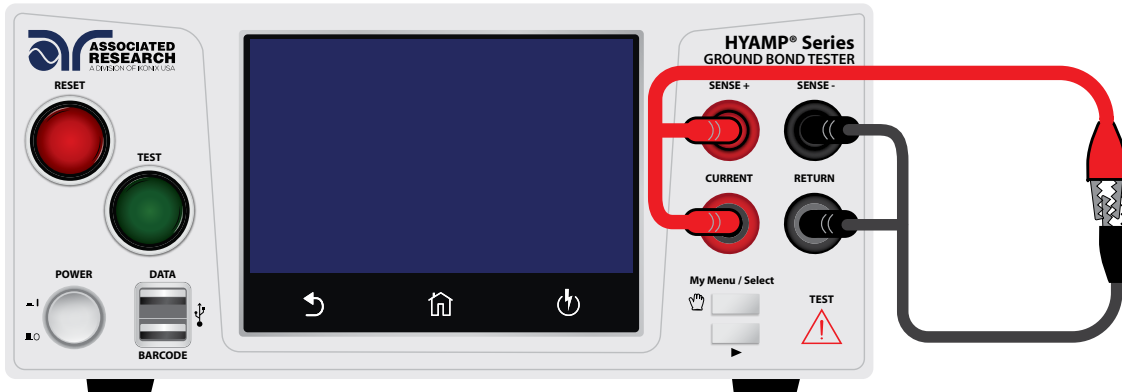

Connect the Red and Black alligator clips together.

To perform mOhms or Voltage Auto Offset short Red Current/Sense+ Lead with Black Return/Sense- Lead.

Push TEST button. The instrument will Auto Offset measurements and save the value to the test step.\*

\*Note: Performing either mOhms or Voltage Auto Offset will set two values, mOhms and Voltage offset parameters of the test step.

## Test Parameters Description

| Ground Bond Test Parameter | Description  |
|----------------------------|--|
| Voltage                    | No load voltage applied between high current and return terminals during Ground Bond test.   |
| Current                    | The current applied during Ground Bond Test.   |
| Hi-Limit Volt              | The maximum voltage drop threshold that triggers a failure when exceeded.  |
| Lo-Limit Volt              | The minimum voltage drop threshold that triggers a failure when not exceeded.  |
| HI-Limit                   | The maximum current or resistance threshold that triggers a failure when exceeded.   |
| LO-Limit                   | The minimum current or resistance threshold that triggers a failure when not exceeded.   |
| Dwell Time                 | The length of time that is allowed for the programmed test voltage to be applied.  |
| Frequency                  | The frequency of the applied voltage or current. Select between 50 and 60 Hz.  |
| Offset                     | <p>Used to factor out resistance due to test leads or test fixture. Set manual or measure automatically.</p> <p>To automatically set an Offset value, set the output, current, and frequency to the values you will use on the DUT and connect the test cables, test fixture to the instrument. Next, for the Ground Bond, short the ends of the test cables and press the TEST button. The instrument will beep and automatically update the new value in the field. You do not need to select the ENTER key for the new parameter to be accepted. For the Ground Bond, performing either milli-ohm or voltage auto-offset will automatically update both mill-ohm and voltage offset values.</p> <div style="border: 1px solid black; background-color: #FFD700; padding: 5px; display: inline-block;"><b>CAUTION</b></div> Please be aware that the program will activate high current when the output connector while the TEST button is pressed. <p>Note: Do not connect the DUT to the instrument when performing an offset. This will create erroneous results when you perform a test.</p> |
| Prompt                     | The Prompt function allows you to insert a short line of text in a step. The Prompt will appear on the screen before the step is initiated and remains on the screen until you press the TEST button. After you press the TEST button, the Prompt will clear and the step will initialize.   |

## View Test Files

Once you have programmed and saved all tests, navigate to the Main Menu. Select the Setup Tests icon and select the test file that you previously created. The screen should display all tests that you have programmed in this test file. For example:

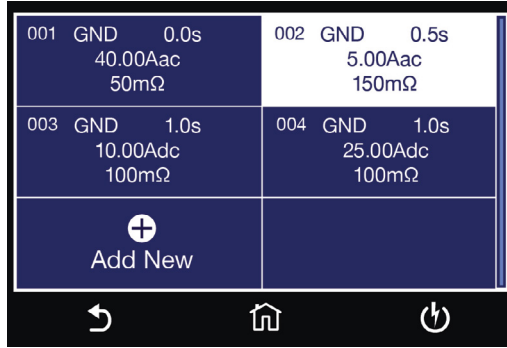

|                                   |                                   |
|-----------------------------------|-----------------------------------|
| 001 GND 0.0s<br>40.00Aac<br>50mΩ  | 002 GND 0.5s<br>5.00Aac<br>150mΩ  |
| 003 GND 1.0s<br>10.00Adc<br>100mΩ | 004 GND 1.0s<br>25.00Adc<br>100mΩ |
| +<br>Add New                      |                                   |

## Edit Test Files

Once you have programmed and saved all test files you can edit these files from the Setup Test menu. From the main menu select Setup Test. The next screen will display all the test files that are stored on the instrument memory.

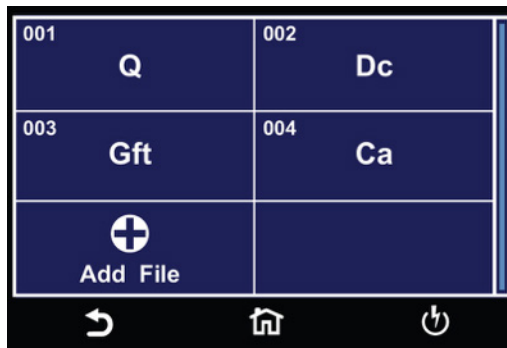

|               |        |
|---------------|--------|
| 001 Q         | 002 Dc |
| 003 Gft       | 004 Ca |
| +<br>Add File |        |

To edit test files touch and hold the screen on a test file name and the screen should change to the following:

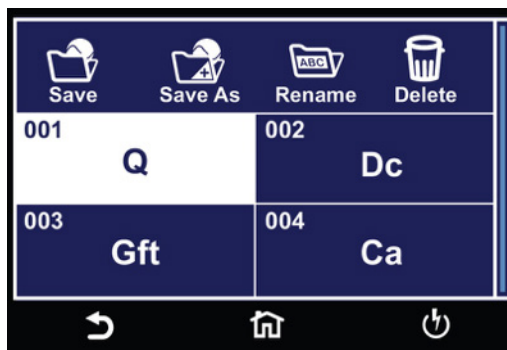

|         |         |        |        |
|---------|---------|--------|--------|
| Save    | Save As | Rename | Delete |
| 001 Q   | 002 Dc  |        |        |
| 003 Gft | 004 Ca  |        |        |

Select the test file and choose the operation you wish to perform from the following:

|                |   |
|----------------|---|
| <b>Save</b>    | Make changes to an existing test file and save the changes              |
| <b>Save As</b> | Edit an existing test file and save the test file with a different name |
| <b>Rename</b>  | Rename an existing test file  |
| <b>Delete</b>  | Delete an existing test file  |

If you choose to delete an existing test file a confirmation screen will appear as follows:

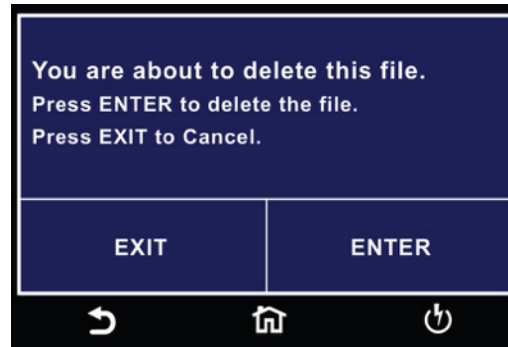

Select Exit to cancel deleting the test file or Enter to confirm the action.

### 3. Perform Tests

From the main menu select the Perform Test icon and the Perform Test screen will appear.

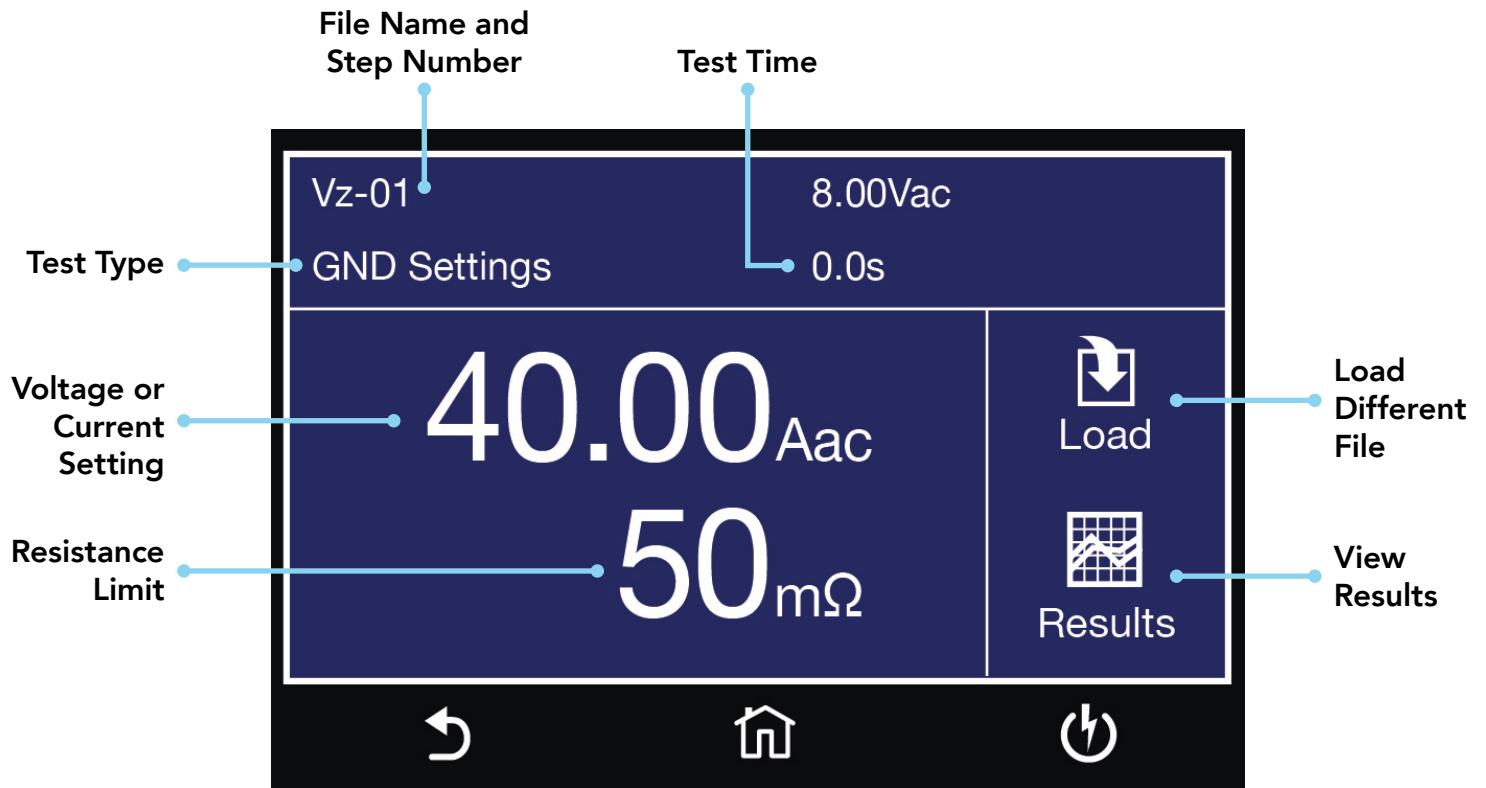

Perform Tests Screen

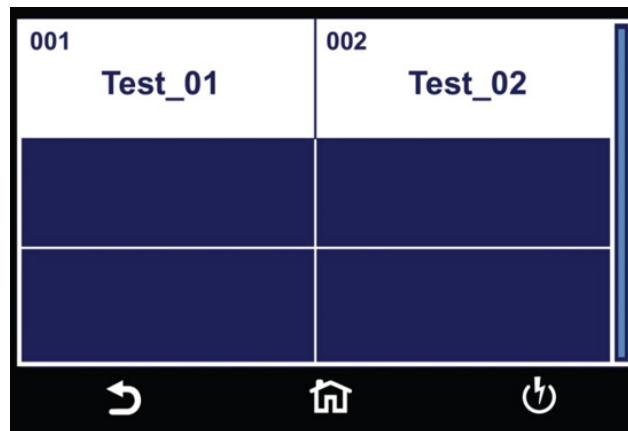

Load Test screen, if there are multiple test files saved in the instrument select the Load icon and all the test files will be displayed. You can select the test file and the first test step in the selected test file will be displayed.



## Instrument Connections

You may connect the test leads to the receptacles located on the front or back of HYAMP. These receptacles are wired in parallel and you can use either depending upon the application.

### Test Lead Connections

- 1 Connect the black return test lead to the black Return terminal located on the front panel of the instrument.
- 2 Connect the sense lead to the Sense(-) terminal located just above the Return terminal.
- 3 Clip the end of the black return test lead to the chassis ground of the DUT.
- 4 Connect the red high current test lead to the red Current terminal on the front panel of the instrument.
- 5 Connect the red high current sense lead to the red Sense(+) terminal.
- 6 Connect the end of the red high current test lead clip to the ground/earth contact of the DUT.

### Class I Product

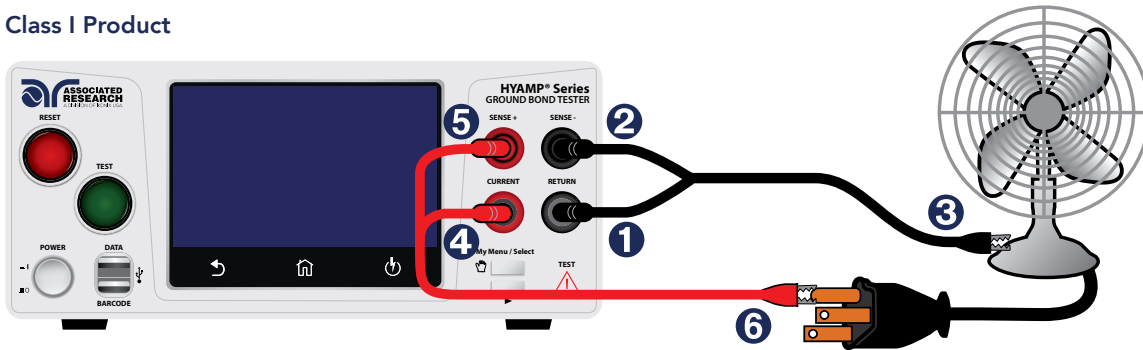

## Failure Modes

| GND Failure Modes     | Description  |
|-----------------------|--|
| <b>Abort</b>          | This message appears on the display if you abort the test in process with the RESET button or remote Reset control.  |
| <b>HI-Limit</b>       | This message appears on the display if the DUT measurement exceeds the HI-Limit setting of any parameter.  |
| <b>LO-Limit</b>       | This message appears on the display if the DUT measurement drops below the LO-Limit.   |
| <b>Interlock Open</b> | This message appears on the display if the Remote Interlock feature is activated before or during a test. The Remote Interlock feature utilizes a set of closed contacts which will disable the instrument's output if they are opened before or during a test. You can also refer to the Remote Interlock as a remote system lockout, utilizing "fail when open" logic. You can disable the Remote Interlock feature by plugging the "Interlock Disable Key" provided into the Signal Input connector |
| <b>Hi-Lmt V</b>       | This message appears on the display if the maximum voltage drop threshold was exceeded.  |
| <b>Lo-Lmt V</b>       | This message appears on the screen if the minimum voltage drop threshold was not exceeded.   |

## Error Messages

**Output Error:** This message appears on the display, if the instruments output reading does not match the setting. You will only see this message if you press the EXIT key at the Output Error screen. If the instrument has an output problem when the TEST button is pressed, the Output Error screen will appear as follows:



The RESET button is not active in this situation. Only the EXIT key will allow you to return to the Perform Test screen.

## Meters

The Perform Test screen of the HYAMP has several different meters depending on the type of test you are performing. You can arrange these meters as desired. You can also tie these meters to the user security setup. The drag and drop feature of the instrument allows you to set large and small meters. For example the following screen shot shows the Perform Test screen of the GND DC test:

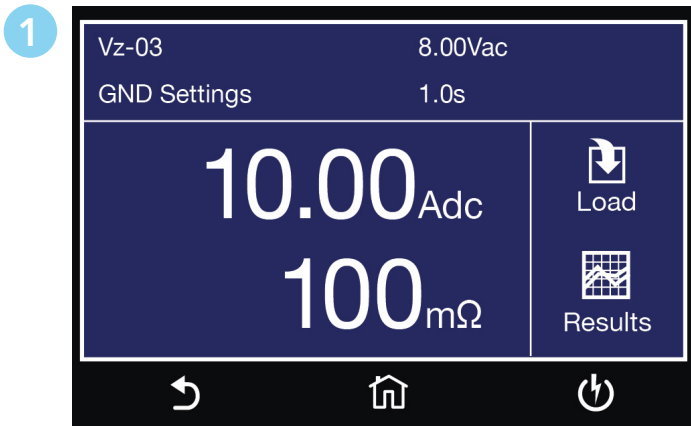

In the image above, the two large meters display the current and Hi-limit setting.

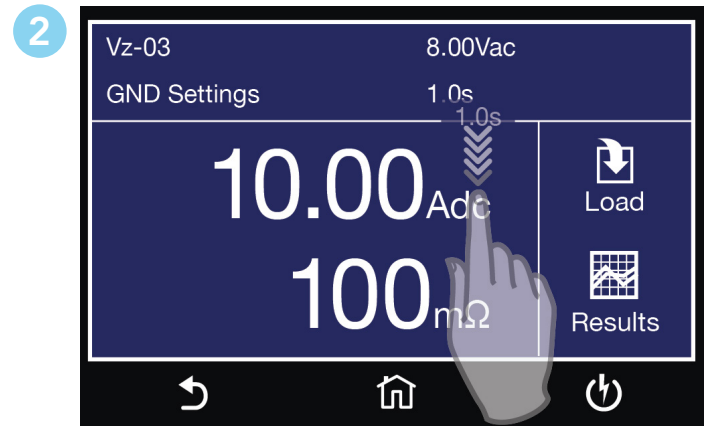

Touch and hold the display on any of the meters and drag it on to the location of a different meter and the two meters will be swapped.

## Viewing Test Results

After a test has completed the Results icon will be available on the screen. For example:

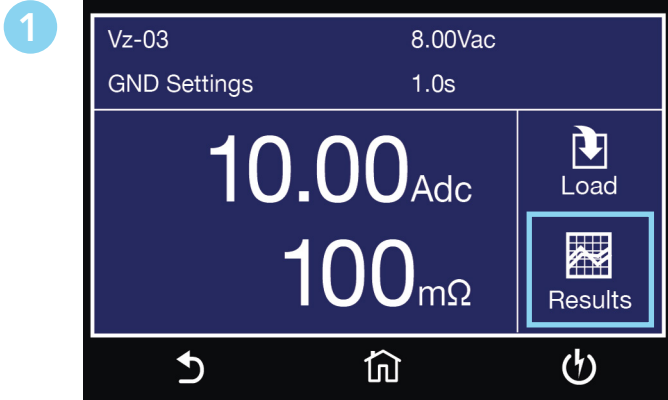

Select the Results icon to enter the results screen.

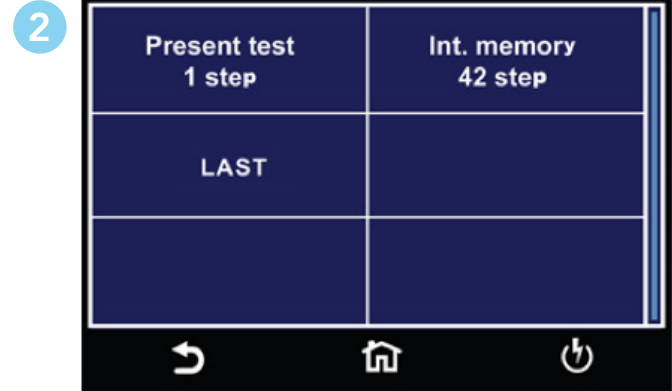

The Results screen will appear. The Results screen allows you to view the results of the last test step the instrument performed and the results of the previously performed tests.

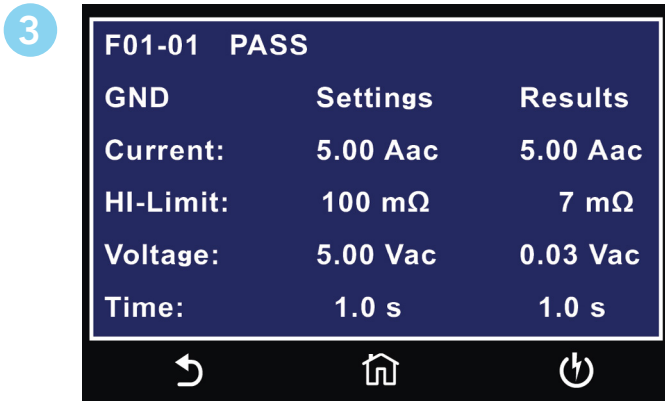

Select Present Test to view test results from the current test sequence that was executed. Select any test step to view more details regarding the test.

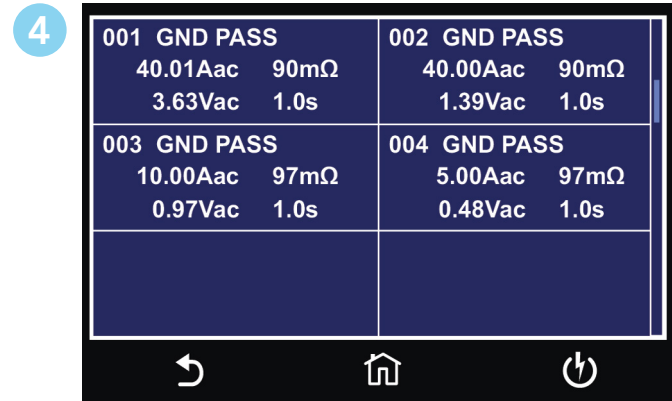

Select Int. Memory to view all the test results stored on the internal memory of the instrument. Scroll down to view all the test results.

## Transfer Test Results

Touch and hold any test step result on the previous screen and a new screen will pop up:

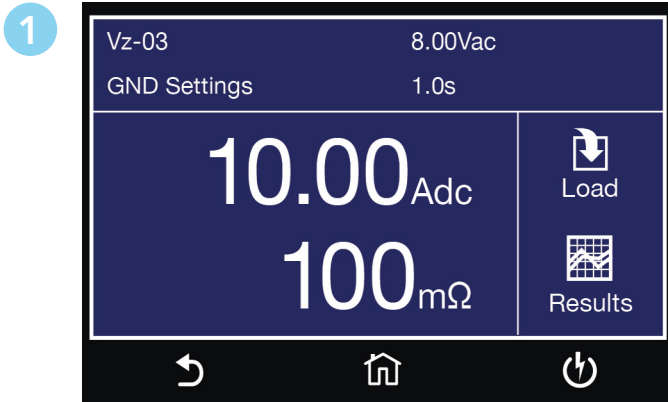

Perform Test Screen.

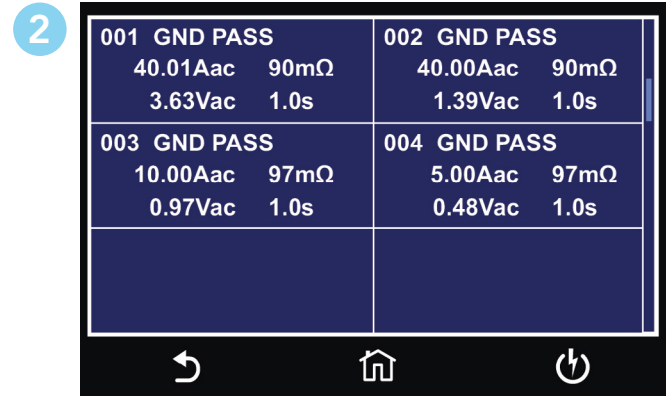

Tap Results icon.

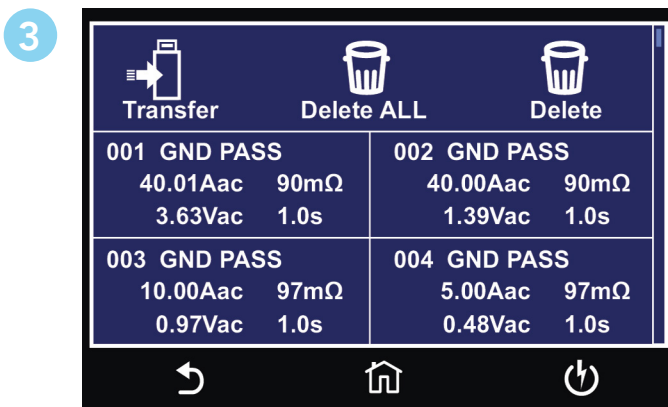

Select Result(s) to transfer or delete.



Enter name for Results File.

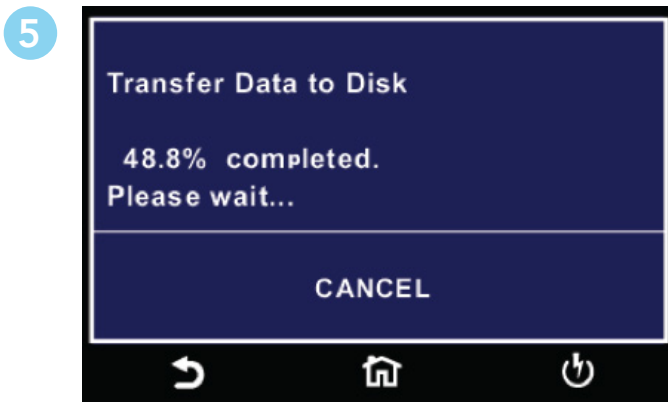

Transfer results progress.

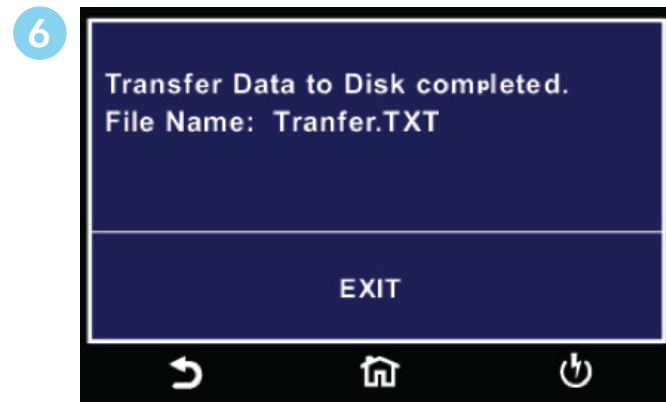

Transfer results complete.

From this screen you can transfer All results to a USB disk, delete All results or delete a single result. Selecting Delete ALL will delete all the test results from the internal memory. Selecting delete will delete a selected step.

To transfer results to a USB disk select the Transfer icon and a new pop up screen will appear where a file name must be entered for the results file. The results will be saved on the USB disk with this file name:

Once you assign and save a file name the following screen will appear showing the transfer status:

Once the results file transfer is complete a message will appear on the screen confirming the successful transfer along with the results file name that was previously assigned.

# 4. Security

Instrument security and user setup screen. The first option under Security allows you to set Security to ON or OFF.

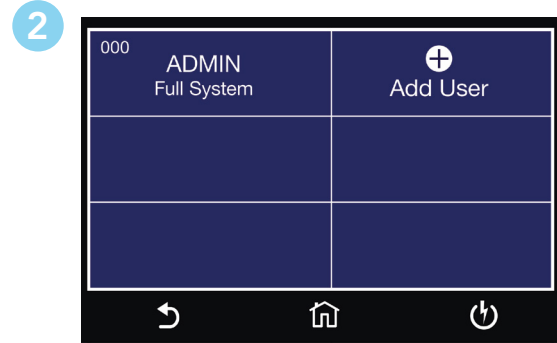
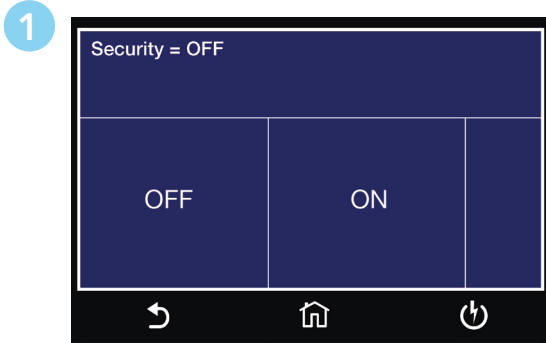
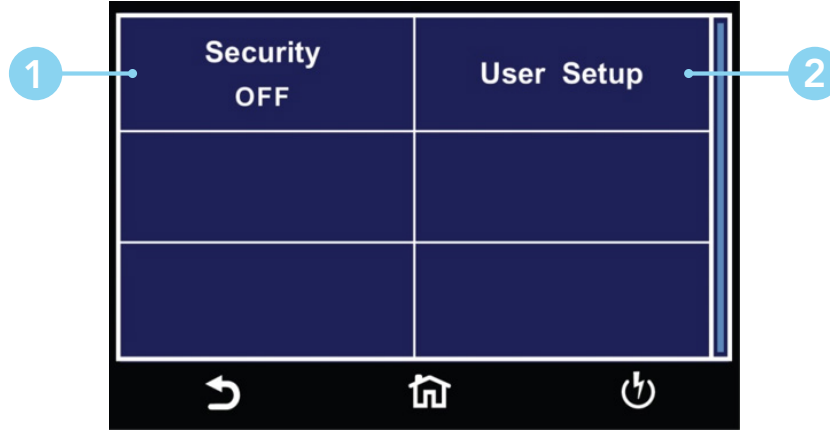

## User Setup

The next option under security is User Setup where multiple users can be added and assigned different privileges.

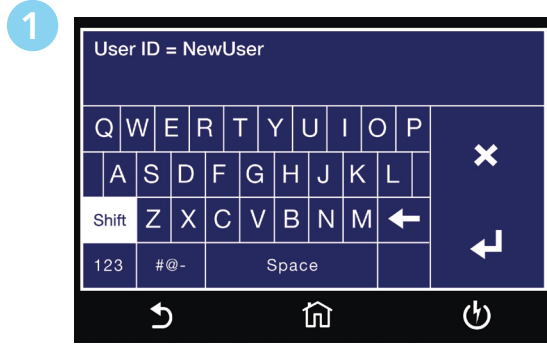

Enter New User ID.

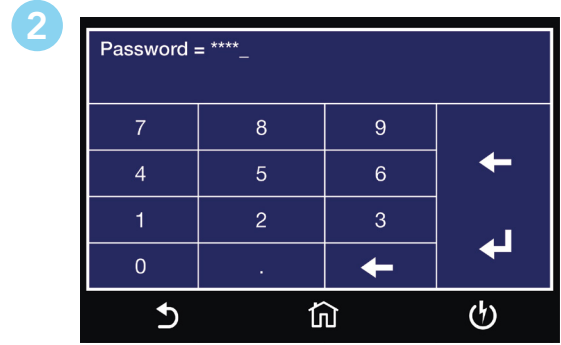

Enter Password.

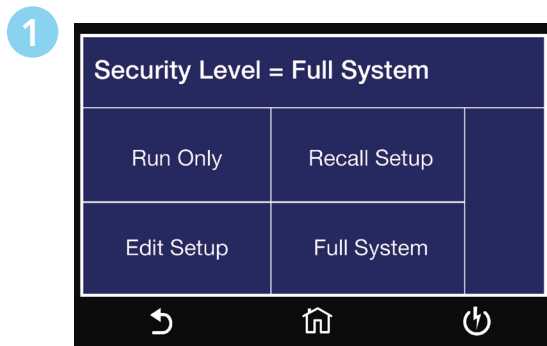

Select Security Level.

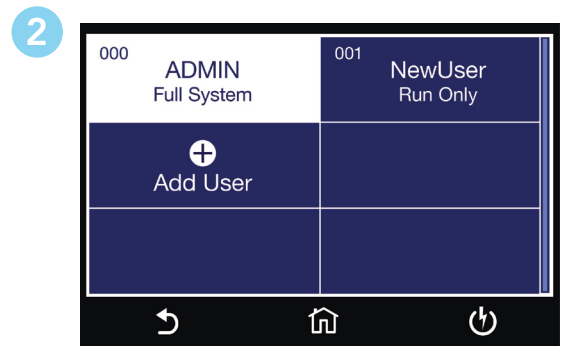

User Setup Menu updated.

| Security Level      | Description  |
|---------------------|--|
| <b>Full System</b>  | In this mode you have full access level to all instrument setup parameters as well as system configuration and security levels. Access at this level should be restricted to System Administrators   |
| <b>Edit Setup</b>   | In this mode you can load files and edit test parameters.  |
| <b>Recall Setup</b> | This mode allows you to load previously configured test files but it does not allow any editing of the parameters. In this mode you are restricted from access to the "Setup Test Parameters" screen.  |
| <b>Run Only</b>     | <p>This is the most restricted mode of user access. You can only initiate a test, reset a failure or abort a test from the Perform Tests screen.</p> <p><b>NOTE:</b> whenever your security level is Run Only, "Single Step" and "Fail Stop" soft keys will be disabled at the Perform Test screen.</p> <p><b>NOTE:</b> whenever your security level is Run Only, you may only start at test step 1.</p> |

### Security – Forgotten Password

If you have forgotten your password you may access all security functions by typing in the number "8000" into the password field. The old password cannot be recovered and a new password needs to be entered.

## 5. FailCHEK

FAILCHEK is the process by which an instrument's failure detectors are proven to be functioning properly. Safety agencies such as CSA, UL and TÜV require checking the failure detection circuitry of the electrical safety instrument. To perform FAILCHEK touch the test icon and follow instructions on the instrument screen.

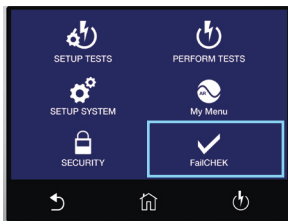

Main Menu

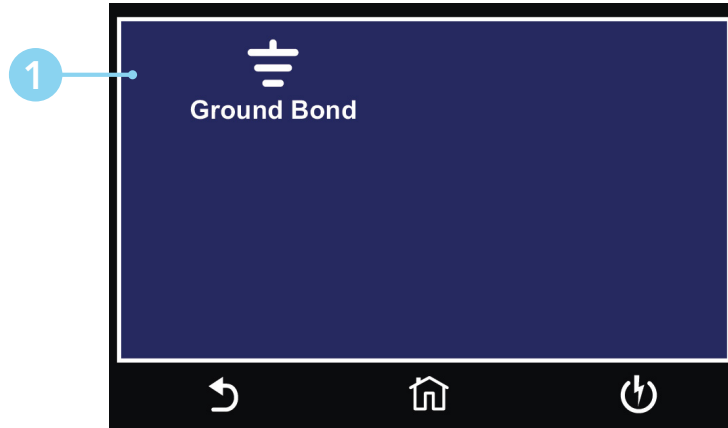

FailCHEK Menu

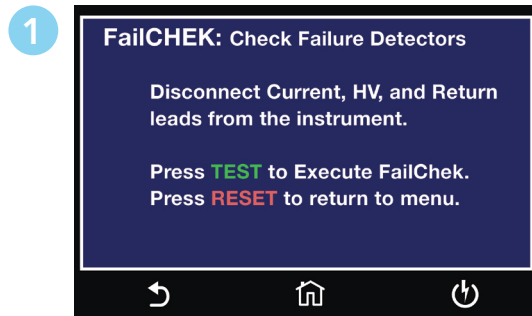

Ground Bond FailCHEK screen

### FailCHEK Ground Bond

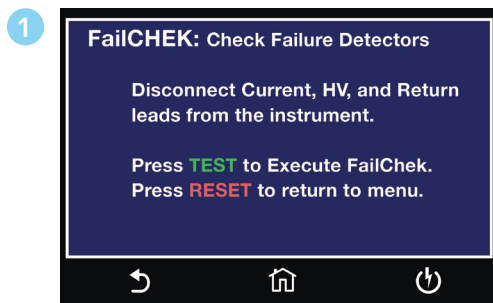

To perform Continuity FailCHEK follow on-screen instructions.

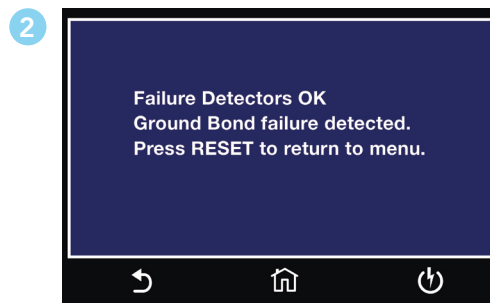

Ground Bond Fail Detectors OK screen.

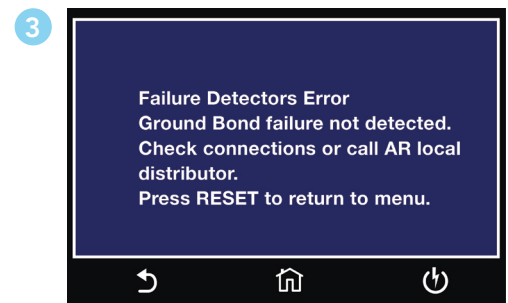

Ground Bond Fail Detectors ERROR screen.



## 6. MyMenu

The MyMenu function allows the user to configure a custom menu. User can store the desired test files under MyMenu and access the files by a single touch.



Main Menu

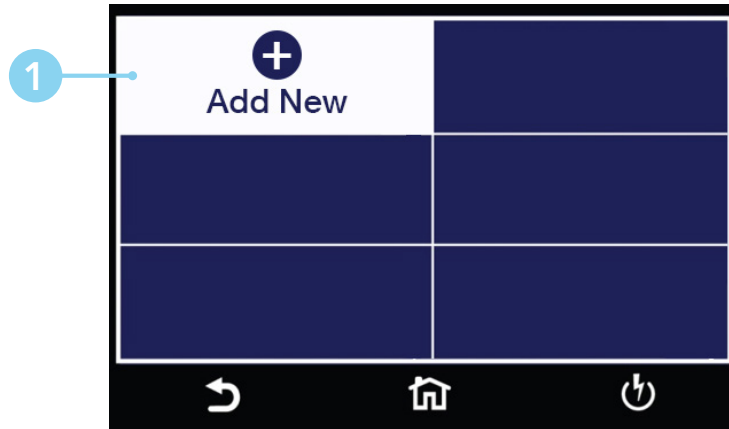

Select Add New to add test file to MyMenu



Select file to be added to MyMenu.

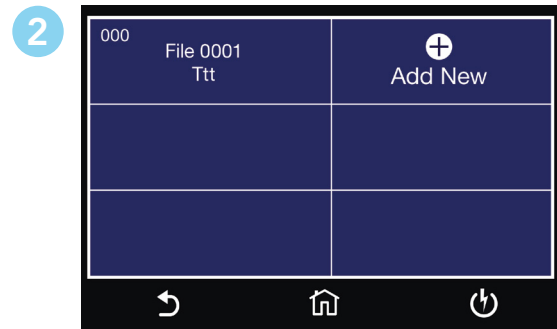

MyMenu Screen.

# Using Remote I/O and PLC Control

Two 9-pin "D" type connectors mounted on the rear panel provide REMOTE-INPUT-OUTPUT control and information.

- These connectors mate with a standard 9 pin D-sub-miniature connector provided by the user.
- The output mates to a male (plug) connector while the input mates to a female (receptacle) connector.
- For best performance, you should use a shielded cable. To avoid ground loops you should not ground the shield at both ends of the cable.

## Suggested AMP part numbers for interconnecting to the Remote I/O

| Part Number | Description  |
|-------------|--|
| 205204-4    | Plug shell with ground indents                       |
| 205203-3    | Receptacle shell                                     |
| 745254-7    | Crimp snap-in pin contact (for plug)                 |
| 745253-7    | Crimp snap-in socket contact (for receptacle)        |
| 745171-1    | Shielded cable clamp (for either plug or receptacle) |
| 747784-3    | Jackscrew set (2)                                    |

## Remote I/O Pinouts

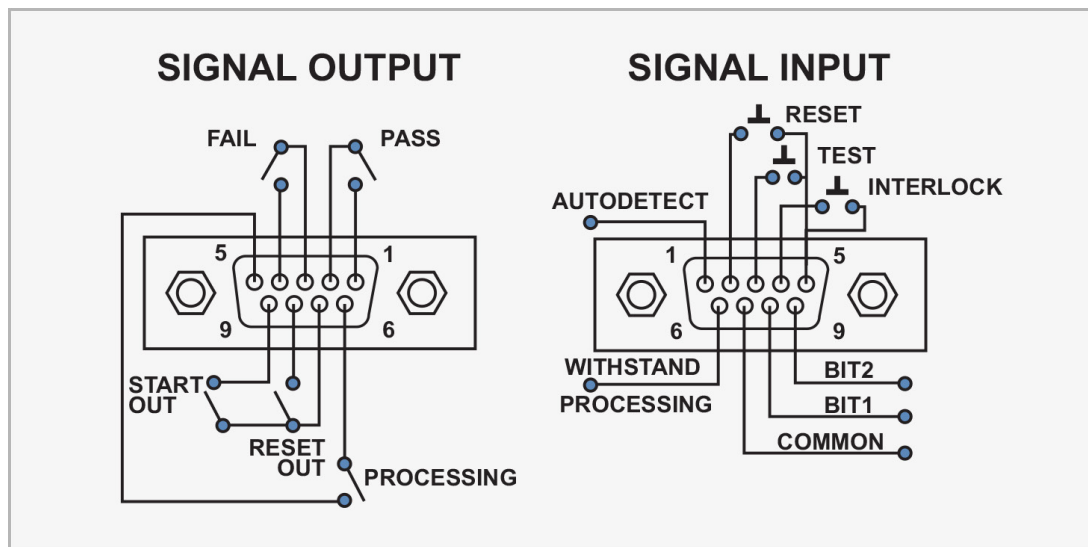

### REMOTE INPUT/OUTPUT

| <b>Remote Output</b> |         | <b>The rear panel connector provides three output signals to remotely monitor PASS, FAIL, and PROCESSING conditions. The monitoring signals are provided by three normally open internal relays that toggle ON and OFF to indicate the condition of the instrument. These are normally open free contacts and will not provide any voltage or current.</b> |
|----------------------|---------|--|
| Output Signal        | Pins    | Description  |
| PASS                 | 1 and 2 | The relay contact closes after detecting that the device under test passed all tests. The connection is opened when the next test is initiated or the reset function is activated.   |
| FAIL                 | 3 and 4 | The relay contact closes after detecting that the device under test failed any test. The connection is opened when the next test is initiated or the reset function activated.   |
| PROCESSING           | 5 and 6 | The relay contact closes while the tester is performing a test. The connection is opened at the end of the test.   |

*These are normally open free contacts and will not provide any voltage or current. The ratings of the contacts are 1 AAC / 125 VAC (0.5 ADC / 30 VDC). When a terminal becomes active, the relay closes thereby allowing the external voltage to operate an external device.*

| <b>Remote Input</b> |         | <b>The HYAMP remote connector enables remote operation of the TEST, RESET, and REMOTE INTERLOCK functions, and allows you to select one of 10 pre-programmed test files.</b>   |
|---------------------|---------|--|
| Output Signal       | Pins    | Description  |
| TEST                | 3 and 5 | A normally open momentary switch can be wired across pins 3 and 5 to allow remote operation of the TEST function. A minimum pulse width or contact closure of 20mS is required to guarantee a test start.  |
| RESET               | 2 and 5 | A normally open momentary switch can be wired across pins 2 and 5 to allow remote operation of the RESET function. For safety, the front panel RESET button remains active even when a remote reset switch is connected so that high voltage can be shut down from either location. A minimum pulse width or contact closure of 50mS is required to guarantee that a running test will abort.  |
| INTERLOCK           | 4 and 5 | <p>Remote Interlock utilizes a set of closed contacts to enable the tester's output. The output of the tester will be disabled under the following conditions:</p> <ul style="list-style-type: none"> <li>• If the Interlock contacts are open and the TEST button is pushed</li> <li>• If the interlock contacts are opened during a test (test will automatically abort)</li> </ul> <p>A pop-up message will be displayed on the screen:</p>  <p>The tester can still be used without the external interlock device as long as the Interlock Connector (P/N # 38075 provided with unit) is plugged into the Remote Interface, Signal Input port. If there is nothing connected to the Remote Interface, Signal Input port to provide a connection to the interlock, the tester will not perform tests.</p> |

*When the PLC Remote mode is ON, the tester will respond to simple switch or relay contacts closures. When the PLC Remote function is ON the TEST button on the front panel will be disabled.*

## Remote Signal Inputs and Memory Access

- The Remote File Select function gives you the capability to quickly select and initiate a test remotely.
- Three pre-programmed test files can be accessed by connecting terminals 7, 8, and 9 in different combinations.
- The memory select bits should be set simultaneously and remain set for a minimum of 20ms to guarantee that the correct memory will be selected.
- The memory select bits may be set in sequential manner, provided that the time delay between each bit is less than 4ms.
- When the desired bit pattern has been established it should remain set for a minimum of 20ms to guarantee that the correct memory will be selected.
- It may be necessary to "OR" the momentary switches (relay contacts) to prevent incorrect program selection due to timing errors.

### DID YOU KNOW...

The Remote Signal Input connector may be used with various accessories, including light curtains, foot switches, and safety probes. Contact Associated Research for more information.

|                   |  |
|-------------------|--|
| Memory Location 1 | Momentarily connecting terminal 7 to 8 signals the instrument to immediately begin the test program that is stored in Memory Location 1.                 |
| Memory Location 2 | Momentarily connecting terminal 7 to 9 signals the instrument to immediately begin the test program that is stored in Memory Location 2.                 |
| Memory Location 3 | Momentarily connecting terminal 7 to terminals 8 and 9 signals the instrument to immediately begin the test program that is stored in Memory Location 3. |

### WARNING

Activating memory program functions through the remote connector, selects the program and starts the test which is preprogrammed into that memory

Activation des fonctions de mémoire programme via le connecteur remote , sélectionne le programme et lance le test qui est préprogrammé dans cette mémoire

### CAUTION

Do not connect voltage or current to the signal inputs, this could result in damage to the control circuitry.

Ne pas connecter tension ou de courant aux entrées de signal, cela pourrait provoquer des dommages au circuit de contrôle

# Appendix A - Installation and Test Operator Information

## Installation

### 1. Unpacking and Inspection

Your instrument ships in a custom foam insulated container. If the shipping carton is damaged, inspect the contents for visible damage such as dents, scratches or a broken display. If the instrument is damaged, notify the carrier and Associated Research's customer care department. Please save the shipping carton and packing material for the carrier's inspection. Our customer care department will assist you in the repair or replacement of your instrument. Please do not return your product without first notifying us and receiving an RMA (return material authorization) number. To receive an RMA number, please contact our customer care department at **1-800-858-TEST (8378)**.

### 2. Safe Lifting and Carrying Instructions

Proper methods of lifting and carrying can help to protect against injury. Follow the recommendations below to ensure that instruments are handled in a safe manner.

- Determine if the instrument can be lifted by one individual or requires additional support.
- Make sure that your balance is centered and your feet are properly spaced, shoulder width apart behind the instrument.
- Bend at the knees and make sure your back is straight.
- Grip the instrument with your fingers and palms and do not lift unless your back is straight.
- Lift up with your legs, not your back.
- Keep the instrument close to your body while carrying.
- Lower the instrument by bending your knees. Keep you back straight

### 3. Contents of the Carton

| DESCRIPTION                       | AR PART NUMBER |
|-----------------------------------|----------------|
| 40 Amp High Current Lead 5'       | 38489          |
| 40Amp High Current Return Lead 5' | 38490          |
| Fuse                              | 38503          |
| USB Cable AB-Type 1.8m            | 39066          |
| Input Power Cable USA 10A*        | 33189*         |
| Interlock Connector               | 38075          |

\*The Line Cord listed is American. Other combinations of the Line Cord are available upon request.

## WARNING

Use only accessories that meet the manufacturer's specification.

Utiliser uniquement des accessoires conformes aux spécifications du fabricant.

## 4. Preparation for Use

### Power Requirements

This instrument requires a power source of either 115 volts AC  $\pm$  10%, 50/60 Hz single phase or 230 volts AC  $\pm$ 10%, 50/60 Hz single phase. See section for Rear Panel Controls for an image of the rear panel.

## CAUTION

Do not replace the power supply cord with an improperly rated cord. For North American: A UL listed and CSA labeled power cord must be used with the instrument in the United States and Canada. The power cord must include a NEMA5-15 style male plug, SVT or SJT cord sets, and be rated for at least 125VAC, 10A, number 16 gauge (or 125VAC, 15A, number 14 gauge) wire or larger, and the length of the cord does not exceed 2 m must be used. For European: A certified power supply cord not lighter than light PVC sheathed flexible cord according to IEC 60227, designation H03 VV-F or H03 VVH2-F (for equipment mass not exceeding 3 kg), or H05 VV-F or H05 VVH2-F2 (for equipment mass exceeding 3 kg), and be rated for at least 3G 0.75 mm<sup>2</sup> (for rated current up to 10 A) or 3G 1.0mm<sup>2</sup> (for rated current over 10 A up to 16 A) wire or larger, and the length of the cord does not exceed 2 m must be used.

Ne remplacez pas le cordon d'alimentation avec un cordon mal classé . Pour l'Amérique du Nord: Une UL et CSA marqué cordon d'alimentation doit être olariz avec l'instrument aux États-Unis et Canada . Le cordon d'alimentation doit comporter une fiche mâle NEMA5-15 de style , SVT ou ensembles SJT de la moelle , et être classé pendant au moins 125VAC , 10<sup>a</sup> , numéro de calibre 16 ( ou 125VAC , 15<sup>a</sup> , numéro de calibre 14 ) fil ou plus, et la longueur de le cordon ne dépasse pas 2 m doit être utilisé . Pour européenne : Un cordon d 'alimentation certifié , pas plus léger que le PVC lumière câbles souples sous gaine selon la norme IEC 60227 , la désignation H03 VV- F ou H03 VVH2 – F ( pour la masse de l'équipement ne dépassant pas 3 kg ) , ou H05 VV- F ou H05 VVH2 – F2 (masse d' équipement de plus de 3 kg) , et être prévus pour au moins 3G 0,75 mm <sup>2</sup> ( pour courant nominal jusqu'à 10 A ) ou 3G 1.0mm<sup>2</sup> ( pour fil nominale ou plus actuelle plus de 10 A à 16 A ) , et la longueur du cordon ne doit pas excéder 2 m doit être utilisé.

## WARNING

The HYAMP must be connected to a good ground. Be certain that the power wiring is properly polarized and that the proper low resistance bonding to ground is in place.

L'HYAMP doit être relié à un bon sol. Assurez-vous que le câblage d'alimentation est correctement polarisé et que la bonne résistance à la terre est en place.

## 5. Power Cable

The instrument is shipped with a line cord containing a protective earth ground. When the line cord is connected to an appropriate AC power source the cable will connect the chassis to earth ground.

## WARNING

Only insert the main plug in a socket outlet with a protective ground (earth) contact. This protective ground must not be defeated by the use of an extension cord without a protective conductor.

La fiche principale ne doit être insérée dans une prise de courant avec une masse (terre ) avec système de protection . Cette terre de protection ne doit pas être vaincu par l'utilisation d' une rallonge sans conducteur de protection.

This instrument is shipped with a three-wire power cable. When this cable is connected to an appropriate AC power source, this cable connects the chassis to earth ground. The type of power cable shipped with each instrument depends on the country of destination.

## Operating Environment

This equipment is intended for indoor use only. The equipment has been evaluated according to Installation Category II and Pollution Degree 2 as specified in IEC 664.

Operate this instrument in environments with the following limits:

Temperature ..... 41° - 104° F (5° - 40°C)

Relative humidity ..... 0 – 80%

Altitude ..... 6560 feet (2,000 meters)

### WARNING

Do not block any ventilation openings to prevent over heating of the equipment. Keep the ventilation slits uncovered during operation. Failure to do so could cause the instrument to overheat and may damage internal components.

Ne pas bloquer les ouvertures de ventilation pour éviter la surchauffe de l'équipement. Gardez les fentes de ventilation découverts au cours de l'opération. Ne pas le faire pourrait entraîner l'instrument de surchauffer et endommager les composants internes.

## Storage and Shipment

Store or ship this instrument in environments with the following limits:

Temperature ..... -40° - 167° F (-40° - 75°C)

Altitude ..... 50,000 feet (15,240 meters)

Also protect this instrument against temperature extremes that may cause condensation within the instrument.

### CAUTION

Failure to operate this instrument within the specified conditions could result in damage.

L'incapacité à manipuler cet instrument dans les conditions spécifiées peuvent entraîner des dommages.

If the instrument is used in a manner not specified by the manufacturer, the protection provided by the instrument may be impaired.

### More Information

For more information on test operator and workstation safety please visit the Events and Training section of our website at [www.arisafety.com](http://www.arisafety.com)

## Test Operator and Safety Considerations

### 1. Qualifications

### WARNING

This instrument generates voltages and currents that can cause harmful or fatal electric shock and must only be operated by a skilled worker trained in its use. The operator should understand the electrical fundamentals of voltage, current, and resistance.

Cet instrument produit des tensions et des courants qui peuvent causer des chocs électriques dangereux ou mortel et ne doivent être exploitées par un travailleur qualifié formé à son olarize ve . L'opérateur doit comprendre les principes fondamentaux électriques de tension, courant et la résistance.

### WARNING

Do not touch the device under test, high current test lead, alligator clip, or clip insulator once the test has been started.

Ne touchez pas l'appareil sous test, le fil de test haute tension, le crocodile ou l'isolateur de clip une fois le test lancé.

## WARNING

Do not touch the front panel when testing or after a malfunction has occurred.

Ne olariz pas la face avant lors de l'essai ou après un dysfonctionnement s'est produit.

*The operator should understand the electrical fundamentals of voltage, current, and resistance.*

## 2. Safety Procedures

Operators should be thoroughly trained to follow these and all other applicable safety rules and procedures before they begin a test. Defeating any safety system should be treated as a serious offense and should result in severe penalties, such as removal from the Hipot testing job. Allowing unauthorized personnel in the area during a test should also be dealt with as a serious offense.

Refer to the following standards for more information:

- NFPA 70E
- OSHA 1910 subpart (S)
- EN50191

## 3. Dress

### WARNING

Operators should not wear jewelry that could accidentally complete a circuit.

Do not observe ESD protocols while performing electrical safety tests. Intentionally grounding the test operator could lead to a harmful or fatal electric shock.

Protocoles de l'EDD ne devraient pas être respectés lors de l'exécution des tests de sécurité électrique. Intentionnellement à la terre à l'opérateur de test pourrait conduire à un choc électrique dangereux ou mortel.

## 4. Medical Restrictions

Inform personnel with heart ailments or devices such as pacemakers that the voltages and currents generated by the instrument are very dangerous. If contacted, the instrument may cause heart-related problems. Please have the test operator consult a physician for recommendations.

## 5. Test Station

### Location

Select an area away from the main stream of activity which employees do not walk through in performing their normal duties. If this is not practical because of production line flow, then the area should be roped off and marked for HIGH VOLTAGE TESTING. No employees other than the test operators should be allowed inside. If benches are placed back-to-back, be especially careful about the use of the bench opposite the test station. Signs should be posted: "DANGER - HIGH VOLTAGE TEST IN PROGRESS - UNAUTHORIZED PERSONNEL KEEP AWAY."

### WARNING

The mains plug is used as the disconnecting device and shall remain readily operable. The socket-outlet shall be installed. Near the equipment and shall be easily accessible.

La fiche secteur est utilisée comme dispositif de déconnexion et doit rester facilement opérationnelle. La prise de courant doit être installée. Près de l'équipement et doit être facilement accessible.



## Work Station

Perform the tests on a non-conducting table or workbench, if possible.

There should not be any metal in the work area between the operator and the location where products being tested will be positioned.

Position the instrument so the operator does not have to reach over the product under test to activate or adjust the instrument. If the product or component being tested is small, it may be possible to construct guards or an enclosure, made of a non-conducting material such as clear acrylic, such that the item being tested is within the guards or enclosure during the test, and fit them with switches so that the instrument will not operate unless the guards are in place or the enclosure closed. The outlet which is used to provide power to the instrument should be easily accessible.

Keep the area clean and uncluttered. All test equipment and test leads not absolutely necessary for the test should be removed from the test bench and put away. It should be clear to both the operator and to any observers which product is being tested, and which ones are waiting to be tested or have already been tested. If the instrument is used in a matter not specified by Associated Research the protection provided by the instrument may be impaired.

Do not perform Ground Bond test in a combustible atmosphere or in any area where combustible materials are present.

### KEY SAFETY POINTS TO REMEMBER

- Keep unqualified and unauthorized personnel away from the test area.
- Arrange the test station in a safe and orderly manner.
- Never touch the product or connections during a test.
- In case of any problem, turn off the high current first.

# Appendix B – Instrument Specifications

## 3240 Functional Specifications

Unless otherwise stated, accuracy's are relative to a laboratory standard measurement.

| INPUT                                    |   |            |                                   |
|--|---|------------|-----------------------------------|
| Voltage                                  | 100 - 120VAC / 200 - 240VAC±10% Auto Range  |            |                                   |
| Frequency                                | 50/60Hz ± 5%  |            |                                   |
| Fuse                                     | 10A / 250VAC Slow-Blow  |            |                                   |
| GROUND BOND                              |   |            |                                   |
|  | Range   | Resolution | Accuracy                          |
| Output AC Current, At                    | 1.00 - 40.00  | 0.01       | ± (3% of setting + 3 counts)      |
| Output Voltage, Vac<br>Open Circuit Mode | 3.00 - 8.00   | 0.01       | ± (3% of setting + 3 counts) O.C. |
| Output Frequency, Hz                     | 50Hz/60Hz ± 0.1%, User Selection  |            |                                   |
| Output Regulation                        | ± (1% of output + 0.02A), Within maximum load limits, and over input voltage range. |            |                                   |
| Maximum Loading                          | 1.00 - 10.00A/0 - 600mΩ   |            |                                   |
|  | 10.01 - 30.00A/0 - 200mΩ  |            |                                   |
|  | 30.01 - 40.00A/0 - 150mΩ  |            |                                   |
| SETTINGS                                 |   |            |                                   |
|  | Range   | Resolution | Accuracy                          |
| Lead Resistance Offset, mΩ               | 0 - 100   | 1          | ± (2% of setting + 2 counts)      |
| HI and LO-Limit Resistance, mΩ           | 0 - 150 (30.01-40.00A), 0 = OFF   | 1          | (2% of setting + 2 counts)        |
|  | 0 - 200 (10.01-30.00A), 0 = OFF   |            |                                   |
|  | 0 - 600 (1.00-10.00A), 0 = OFF  |            |                                   |
|  | 0 = Off   |            |                                   |
| Fix Ramp Timer, second                   | 0.1   | 0.1        | ± (0.1% + 0.05 sec)               |
| Dwell Timer, second                      | 0, 0.5 - 999.9<br>(0 = continuous)  | 0.1        | ± (0.1% + 0.05 sec)               |
| HI and LO-Limit Voltage, V               | 0 - 6.00 , 0 = OFF  | 0.01       | ± (2% of setting + 2 counts)      |
| Offset, V                                | 0.00-4.00   | 0.01       | ± (2% of setting + 2 counts)      |

Continued on next page →

| MEASUREMENT                             |  |            |   |
|---|--|------------|---|
|   | Range  | Resolution | Accuracy  |
| AC Current, A                           | 0.00-40.00   | 0.01       | ± (3% of reading + 1 counts)  |
| DC Current, A                           | 0.00-40.00   | 0.01       | ± (3% of reading + 1 counts)  |
| Resistance, mΩ                          | 0-600  | 1          | ± (3% of reading + 3 counts) for 1 - 5.99A,<br>± (2% of reading + 2 counts) for 6 - 40A |
| AC Voltage, V                           | 0.00-8.00  | 0.01       | ± (2% of reading + 2 counts)  |
| DC Voltage, V                           | 0.00-8.00  | 0.01       | ± (2% of reading + 2 counts)  |
| GENERAL SPECIFICATIONS                  |  |            |   |
| Safety Agency Listing                   | CE, TUV SUD, RoHS2   |            |   |
| PLC Remote Control                      | Input: Test, Reset, Interlock, Withstand Processing, Recall File 1 through 3(Standard), Hardware Interlock- Direct control sine wave and amplifier relay off when Interlock signal is disable. |            |   |
|   | Output:- Pass, Fail, Test-in-Process, Reset-out, Start-out<br><br>(Output relay contact ratings is 1AAC/125VAC)  |            |   |
| Memory                                  | 50 steps<br>Internal memory- 1500 test results   |            |   |
| Display                                 | 4.3" Color Display (Touch Panel)   |            |   |
| Multinational language                  | User interface available in English, Traditional Chinese, Simplified Chinese, Turkish, Portuguese, Spanish, German, French   |            |   |
| Interface                               | Standard: USB  |            |   |
| Security (Standard Password Protection) | Programmable User ID and Password capability to avoid unauthorized access to test set-up program.  |            |   |
| Alarm Volume Setting                    | Range: 0 - 9 ; 0 = OFF, 1 is softest volume, 9 is loudest volume   |            |   |
| Calibration                             | Software and adjustments are made through the front panel. Automatic Calibration alert function to signal operator when the next calibration is due.   |            |   |
| Environment                             | Temperature: 0 - 40°C, Humidity: 20 - 80%  |            |   |
| Dimension                               | 215mm(W) ×88.1mm(H) × 300 mm(D)  |            |   |
| Weight                                  | 5kg  |            |   |

# Appendix C - Options

## Introduction

This section contains a list and descriptions of available factory installed options at the time of this printing. The list of options contains an option code number which can be referenced on the model option label on the rear panel of the unit when options are present.

## Model Option Label

On the rear panel of the instrument, you will find a label that contains the option code.

For example, your options code will appear as follows:

fitted with option 01 OPT: 01

fitted with option 01 and 02 OPT: 0102

## HYAMP Options

| CODE | DESCRIPTION       |
|------|-------------------|
| 14   | HA3 Mode          |
| 15   | PLC Ready Output  |
| 17   | Continuous Output |

### 14 HA3 Mode

Allows activation of bus command mimic mode for HYAMP III models 3130 and 3145. The new interface commands and structure of the HYAMP 3240 can emulate those of the HYAMP III interface. This will allow HYAMP III users to integrate the new model into existing test systems easier. For a complete list of bus commands for this option refer to the HYAMP III product manual.

### 15 PLC Ready Output

The PLC Ready Output option creates a signal that acts as an instrument power-on indicator. The signal is available through the Remote Signal Output connector which is located on the back of the instrument. This option closes the relay contact between pin (1) and pin (2) on the output connector once the instrument is powered on. the PLC Power Indicator signal replaces the PASS signal that is present on the standard instrument.

To perform a test, it should be verified that an interlock device is used or the Interlock disable connector that was provided with the instrument is installed and that there are no failure indicators active on the instrument. For more information reference Remote I/O section.

### 17 Continuous Output with PASS Buzzer

The Continuous Output with Pass Buzzer option allows the user to perform multiple Ground Bond tests without the need to repeatedly energize and de-energize the output. All of the standard specifications for the failure judgement and the FAIL indication are the fundamental differences in the operation of the instrument.

To make the best use of the Continuous Output feature, the Dwell timer should be set to 0.0. If the Dwell timer is set to any value other than 0.0 s, the test results will be captured when the timer has completed until the test is restarted.

To start the Ground Bond test, the TEST button on the front panel can be pressed with the leads connected or disconnected from the DUT. Once the test leads are connected to the DUT and the measured resistance is less than the Max Lmt setting and greater than the Min Lmt setting, the instrument will indicate a PASS condition. A PASS condition is represented by an audible alarm and the illumination of the green PASS light on the front panel.

When continuity is broken the instrument measures a resistance value greater than the Max Lmt setting, or lower than the Min Lmt setting, the red FAIL indicator will illuminate and the alarm will turn OFF. The FAIL condition will remain until the resistance drops below the Max Lmt setting or above the Min Lmt setting, or until the RESET button is pressed to de-energize the output.

This operation emulates basic audible Continuity testers found on many multi-meters, and is useful for doing multi-point Ground Bond tests on the DUT.

# Appendix D - Remote BUS Interface: USB

This section provides information on the proper use and configuration of the bus remote interface. The USB remote interface is standard. The IEEE-488 interface included conforms to the requirements of the IEEE-488.2 standard.

## USB Interface

### Communications Port Configuration

The COM port should have the following configuration:

- 38400 baud
- 8 data bits
- 1 stop bit
- No parity

This interface does not support XON/XOFF protocol or any hardware handshaking. The controller should be configured to ignore the handshaking lines DTR (pin 4), DSR (pin 6) CTS (pin 8) and RTS (pin 7). If the port cannot be configured through software to ignore these lines the handshake lines should be jumpered together in two different sets. Pins 4 and 6 should be jumpered together and pins 7 and 8 should be jumpered together at the controller end of the cable.

## Sending and Receiving Commands

### Sending Data

Once a command is sent to the instrument over the USB the instrument will send one of two responses. If the transfer was recognized and completed the instrument will return with 06 hex or 6 decimal, the Acknowledge (ACK) ASCII control code. If there is an error with the command string that is sent, the instrument will respond with 15 hex or 21 decimal, the Not Acknowledge (NAK) ASCII control code. The ACK or NAK response allows for software handshaking to monitor and control data flow.

### Receiving Data

When requesting data from the instrument it will automatically send the data back to the controller input buffer. The controller input buffer will accumulate data being sent from the instrument, including the ACK and NAK response strings, until it has been read by the controller.

## USB Interface Command List

### USB Responses

The USB bus will automatically send any response back to the controller's input buffer.

### Queries and Responses

The HYAMP bus will not send any data to the controller without being queried.

### Rules for Sending Commands to the Instrument

The following conventions are used to describe the commands syntax for HYAMP:

- Braces ( { } ) enclose each parameter for a command string.
- Triangle brackets ( < > ) indicate that you must substitute a value for the enclosed parameter.
- The Pipe ( | ) is used to separate different parameter options for a command.
- The command and the parameter data must be separated with a space.
- Each command string should be terminated by the ASCII control code, New Line (NL), (OAh) or the end of line (EOL) message.
- All commands that end with a question mark ( ? ) are query commands and required an IEEE-488 read command to retrieve the data from the device's output buffer.

## Test Execution Commands

The following commands are used to control actual output voltage and current from the instrument. Please observe all safety precautions.

| COMMAND | DESCRIPTION                               |
|---------|---|
| TEST    | Execute a Test                            |
| RESET   | Abort a test in Process or Reset Failures |
| SAO     | Set Auto-Offset                           |
| SAOV    | Set Auto-Offset Volt                      |

### TEST

Starts the test sequence at the selected step loaded into memory (RAM).

### RESET

Stop or abort a test. Also used to reset a latched failure condition.

### SAO

Set the offset for the Ground Bond test. The cables and any test fixture should be connected before executing the command. This command will perform an actual test and all safety precautions should be observed when using this command.

### SAOV

Set the Voltage offset for the Ground Bond test. The cables and any test fixture should be connected before executing the command. This command will perform an actual test and all safety precautions should be observed when using this command.

## File Editing Commands

The following commands are used to create or modify Test Setup Files.

- Commands should be separated from parameters by a space.
- If multiple parameters are entered, they should be separated by commas.

| COMMAND               | DESCRIPTION                       | VALUE  |
|-----------------------|-----------------------------------|--|
| FL <memory number>    | File Load                         | memory number = 1-10   |
| FL?                   | Query File Number                 | 1-10   |
| FN nn,xxxx            | File Name                         | nn=1-10, xxxx=Name   |
| FR xxxx               | File Rename xxxx                  | xxxx=Name (8 char. max)  |
| FD                    | File Delete                       | Current file in use  |
| FD nn                 | File Delete nn                    | nn=1-10  |
| FS                    | File Save                         | Current file in use  |
| FSA nn,xxxx           | File Save As                      | nn=1-10, xxxx=Name (8 char. max)   |
| FT?                   | File Total                        |  |
| ST?                   | Step Total                        |  |
| SS <step number>      | Step Select step number           | step number = 1-50   |
| SS?                   | Query Step selected               | 1-50   |
| ADD <n,p1,p2,p3...pn> | Add all parameters of a test step | ADD Out Mode, Dwell(s), Current(A), Voltage(V), HI-Limit $\Omega$ (m $\Omega$ ), HI-Limit Volt(V), LO-Limit $\Omega$ (m $\Omega$ ), LO-Limit Volt(V), Offset $\Omega$ (m $\Omega$ ), Offset Volt(V), Frequency*8 |
| SAG                   | Add GND step & default parameters |  |
| SD                    | Step Delete current               |  |
| SD nn                 | Step Delete nn                    | nn=01-50   |
| SP <prompt mes-sage>  | Step Prompt Create                | Prompt message = Valid ASCII (1)<br>Maximum 32 characters  |
| SP                    | Step Prompt Delete                |  |
| LP?                   | List Prompt                       |  |
| LP nn                 | List Prompt current               | 1-50   |

(1) "Valid ASCII" is the character set that is available from the front panel LCD user interface. Consisting of upper case alphabet (A-Z), numbers (0-9) and decimal point (.), asterisk (\*), dash (-), under bar (\_), tilde (~) and space (SP).

FL <memory number>

Load a file by memory number from non-volatile memory into random access memory RAM.

FN < file name>

Creates a new file name for the active memory loaded into RAM.

SS <step number>

Selects the active selected step to load into RAM. The step must first be selected before any specific parameters can be edited.

ADD <n, p1,p2,p3...>

This command adds a step with all parameters to the current file. See the command summary tables below to see the specific test type for each of these commands

The parameter <n> indicates the test type. The values AC or DC must be used. The parameters <p1,p2> etc. indicate the individual settings for each parameter of the test. All parameters must be included with the command and should appear in the same order that is shown in the table below. Also, like the individual parameter editing commands, the unit should not be included with the value; only the numeric value should be included in the command string.

The list of parameters can also be found in the default parameters section of the manual, or refer to Test Parameter Editing Commands and Companion Queries for the proper values.

The parameter values for file editing commands should use complete text (i.e. "ON" and "OFF" or "Real" and "Total") and not use the coded values that are associated with the test parameter setting commands discussed in Test Parameter Editing

Commands and Companion Queries. The LS? companion command will also list all parameters in complete text in the order as they appear in the following table, preceded by the step number. The following table shows examples of the ADD2 and

LS commands:

#### ADD all parameters for one STEP

ADD AC,Dwell,Current,Voltage,Hi-Limit,High-Limit Volt,Lo-Limit,Lo-Limit Volt,Offset Ohm,Offset Volt,Freq\*

\* freq only for AC

#### LS? & LS nn? Response Data format

Step number, Output Mode, Dwell, Current(A), Voltage(V), HI-Limit  $\Omega$ (m $\Omega$ ), HI-Limit Volt(V), LO-Limit  $\Omega$ (m $\Omega$ ), LO-Limit Volt(V), Offset  $\Omega$ (m $\Omega$ ), Offset Volt(V), Frequency(only AC test)



|    | GND        |
|----|------------|
| 1  | Current    |
| 2  | Voltage    |
| 3  | HI-Limit   |
| 4  | LO-Limit   |
| 5  | HI-Limit V |
| 6  | LO-Limit V |
| 7  | Dwell Time |
| 8  | Offset     |
| 9  | Offset V   |
| 10 | Frequency  |

### ADD Command String Examples

Use the following ADD command string to setup a corresponding test with the listed parameters. The command string below can be copied exactly as it appears. The parameters can be edited and sent to the tester via BUS command.

#### Ground Bond

| Test | Dwell Time | Current | Voltage | HI-Limit | HI-Limit V | LO-Limit | LO-Limit V | Offset | Offset V | Frequency |
|------|------------|---------|---------|----------|------------|----------|------------|--------|----------|-----------|
| AC   | 1.0        | 35.00   | 8.00    | 100      | 6.00       | 0        | 0.00       | 0      | 0.00     | 60        |

ADD AC,1.0,35.00,8.00,100,6.00,0,0.00,60

**SP <prompt message>**

Adds or edits a prompt message for the active step.

**SP**

Removes or deletes the prompt that had been created for the active step.

**Test Parameter Editing Commands and Companion Queries**

These commands are used to modify the test parameter within each step. These commands require a parameter value to be included with the command. The companion query command will read the parameter. The writing of the parameter requires that the unit not be included with the value, only the numeric value should be included with the command. Also, when the query commands are used the response will not include the unit's characters. Many of the commands will function the same way for multiple test types; however, the input range may be different and therefore used a different possible set of values.

| COMMAND               | NAME                    | TEST TYPES  | VALUE  |
|-----------------------|-------------------------|-------------|--|
| EV < value ><br>EV?   | Edit Voltage            |             | n=3.00 - 8.00V   |
| EHV n                 | Edit Hi-Limit Volt n    |             | 0.00-6.00<br>Unit:Volts  |
| EC nnnn<br>EC?        | Edit Current            |             | 1 - 40A  |
| EDW < value ><br>EDW? | Edit Dwell              |             | 0, 0.5 - 999.9s  |
| EO < value ><br>EO?   | Edit Offset             | CONT<br>DCW | 0.0 – 100mΩ  |
| EOV nnnn<br>EOV?      | Edit Offset             | GB          | 0.00 ~ 4.00V   |
| EH < value ><br>EH?   | Edit HI-Limit           |             | <value><br>=0~150(30.1~40.0A)<br>=0~200(10.1~30.0A)<br>=0~600(1.0~10.0A)<br>mΩ |
| EHV?                  | Query Hi-Limit Volt     |             | 0.00-6.00  |
| ELV n                 | Edit LO-Limit Volt n    |             | n=0.00-6.00  |
| ELV?                  | Query Lo-Limit Volt?    |             | 0.00-6.00  |
| EGO n                 | Edit ouput mode n       |             | n=0-1, 0=AC, 1=DC  |
| EGO?                  | Query Output Mode n     |             | 0=AC, 1=DC   |
| EL < value ><br>EL?   | Edit Min-Lmt / LO-Limit |             | =0~150(30.1~40.0A)<br>=0~200(10.1~30.0A)<br>=0~600(1.0~10.0A)<br>mΩ            |
| EF n<br>EF?           | Edit Frequency          |             | 0=50Hz, 1=60Hz,  |

Continued on next page →

## System Parameter Editing Commands and Companion Queries

These commands are used to modify the system parameters for the instrument. These commands require a parameter value to be included with the command. The companion query command will read the parameter using the same value that is used for setting the parameter.

| COMMAND                 | NAME                     | VALUE  |
|-------------------------|--------------------------|--|
| SPR {1 0}<br>SPR?       | PLC Remote               | 1= On, 0=Off   |
| SSI {1 0}<br>SSI?       | Single Step              | 1= On, 0=Off   |
| SF {1 0}<br>SF?         | Fail Stop                | 1= On, 0=Off   |
| SAL < value ><br>SAL?   | Alarm Volume             | 0-9  |
| SL {1 0}<br>SL?         | Lock                     | 1= On, 0=Off   |
| SR {2 1 0}<br>SR?       | Results                  | 0=ALL, 1=P/F, 2=LAST   |
| SCA {1 0}<br>SCA?       | Cal Alert                | 1= On, 0=Off   |
| SCDA < value ><br>SCDA? | Cal Date                 | mm,dd,yy or yy,mm,dd or dd,mm,yy according to SDF setting            |
| SCDU < value ><br>SCDU? | Cal Due                  | mm,dd,yy or yy,mm,dd or dd,mm,yy according to SDF setting            |
| SA < value ><br>SA?     | Alert Date               | mm,dd,yy or yy,mm,dd or dd,mm,yy according to SDF setting            |
| SDT < value ><br>SDT?   | System Date              | mm,dd,yy or yy,mm,dd or dd,mm,yy according to SDF setting            |
| SDF < value ><br>SDF?   | Date Format              | 0=yy,mm,dd, 1=mm,dd,yy, 2=dd,mm,yy                                   |
| STM < value ><br>STM?   | Time                     | hh,mm (24hr)<br>hh,mm,AM or hh,mm,PM (12hr) according to STF setting |
| STF {1 0}<br>STF?       | Time Format              | 0=12hr, 1=24hr   |
| SIS xxxxxxxx            | Import System            | xxx=name   |
| SIF xxxxxxxx            | Import File              | xxx=name   |
| SRF?                    | Read USB.HU4 File        |  |
| SRAS?                   | Read USB .AS file        | File name returned   |
| SRAF?                   | Read USB .AF file?       | File name returned   |
| SRAD?                   | Read USB .AFS file?      | File name returned   |
| SIAF xxxxxxxx           | Import File xxxxxxxx     | xxxxxx=Name  |
| SIAD xxxxxxxx           | Import All Data xxxxxxxx | xxxxxx=Name  |
| SEAF xxxxxxxx           | Export All file xxxxxxxx | xxxxxx=Name  |

Continued on next page →

|                               |  |  |
|-------------------------------|--|--|
| <b>SEAD xxxxxxxx</b>          | Export All Data xxxxxxxx                   | xxxxxx=Name  |
| <b>SVG</b>                    | Perform FailChek                           | ACK  |
| <b>SVG?</b>                   | Perform FailChek result                    | 0-2, 0=fail, 1=processing, 2=pass  |
| <b>SFW?</b>                   | Read Software version                      | Version  |
| <b>Name xxx</b>               | Edit Instrument Name xxx<br>(20 chars max) | ACK  |
| <b>Name?</b>                  | Query instrument name                      | Instrument name  |
| <b>SES xxxxxxxxx</b>          | Export System                              | xxx=name   |
| <b>SEF xxxxxxxxx</b>          | Export File                                | xxx=name   |
| <b>SMM n<br/>SMM?</b>         | Home Screen                                | 0=Perform Tests, 1=Menu, 2=My Menu   |
| <b>SLA n<br/>SLA?</b>         | Language                                   | 0=English, 1=Traditional Chinese<br>2=Simplified Chinese,3=Spanish<br>4=Portuguese, 5=Turkish<br>6=German, 7=French  |
| <b>STS n<br/>STS?</b>         | Touch Sound                                | =Off, 1=On   |
| <b>SDUT n<br/>SDUT?</b>       | Dual Test                                  | 0=Off, 1=On  |
| <b>STR n<br/>STR?</b>         | Test Results                               | 0=None, 1=Fail, 2=Pass, 3=All  |
| <b>SRN xxxxxxxxx<br/>SRN?</b> | Results Name                               | xxx=name   |
| <b>SUL n?</b>                 | User                                       | SUA Pointer,Name,Password,Level<br>Pointer: 1-299<br>Name: 8 character max<br>Password: 8 number max<br>Level: 0=Run Only,<br>1=Recall Setup,<br>2=Edit Step,<br>3=Full System |
| <b>SUA p,p,p,p</b>            | Add new user                               | SUA Pointer,Name,Password,Level<br>Pointer: 1-299<br>Name: 8 character max<br>Password: 8 number max<br>Level: 0=Run Only,<br>1=Recall Setup,<br>2=Edit Step,<br>3=Full System |
| <b>SUD n</b>                  | User Delete                                | n=1-299  |
| <b>SUE p,p,p,p</b>            | User Edit                                  | SUA Pointer,Name,Password,Level<br>Pointer: 1-299<br>Name: 8 character max<br>Password: 8 number max<br>Level: 0=Run Only,<br>1=Recall Setup,<br>2=Edit Step,<br>3=Full System |

Continued on next page →

|                             |                          |  |
|-----------------------------|--------------------------|--|
| <b>SAS n</b><br><b>SAS?</b> | Auto Start Format        | 0=Off, 1=On  |
| <b>SBI n</b><br><b>SBI?</b> | Barcode IP Format        | 0=Off, 1=Ser/Prod, 2=Serial#, 3=Product#, 4=Run File |
| <b>SHS n</b>                | Edit Hipot Start n       | n=0-1  |
| <b>SHS?</b>                 | Query Hipot Start?       | 0-1, 0=G->W, 1=G+W                                   |
| <b>SDM n</b>                | Edit Diagnostic Memory n | 0=off, 1=on  |
| <b>SDM?</b>                 | Query Diangostic Memory? | 0=off, 1=on  |
| <b>SHA3 n</b>               | Edit Model n             | n=0-2, 0=3240, 1=3130, 2=3145                        |
| <b>SHA3?</b>                | Query Model?             | 0-2, 0=3240, 1=3130, 2=3145                          |
| <b>SCS n</b>                | Edit Color Style n       | 0=White, 1=Black, 2=Blue                             |
| <b>SCS?</b>                 | Query Color Style?       | 0=White, 1=Black, 2=Blue                             |

## Query Commands

These query commands will retrieve data from the instrument. The GPIB bus application requires an IEEE-488 read command to be sent after the query command. These commands include functions for retrieving test data, test results and remote hardware status, as well as setup file information.

| COMMAND           | NAME                                | VALUE                  |
|-------------------|-------------------------------------|------------------------|
| TD?               | List Testing Data                   | Test In Process        |
| RD <step number>? | List Results Data                   | step number = 1-200    |
| RR?               | Read Remote Reset                   | 1=Open, 0=Closed       |
| RI?               | Read Remote Interlock               | 1=Open, 0=Closed       |
| RU?               | Read USB Stick                      | 0=NO, 1=YES            |
| LF?               | List File Name                      | Active selected memory |
| LF nn?            | List File Name                      | Active selected file   |
| LP?               | List Prompt                         | Active selected Step   |
| LP <step number>? | List Prompt by step number          | Step number = 1-200    |
| LS?               | List Step Parameters                |                        |
| LS <step number>? | List Step Parameters by step number | Step number = 1-200    |

### TD?

Read the active data being displayed on the LCD display while the test is in process. Also read the last data taken when the test sequence has completed. Each parameter is separated by commas and includes step number, test type, test status, and metering. The syntax for this command response is {step, test type, status, meter 1, meter 2, meter 3}. ACW test displays 4 meters. Each meter will contain only the value and not the units. In the case of DCW current where both uA and mA are used on the display, the command response will always indicate the current in uA for example 2.0mA will respond with 2000 for 2000uA.

### RD <step number>?

Read the results for an individual step. The step number is the actual step number that has been saved within the file, not the order of which the steps were executed. For example if the test was executed starting from step 3 and ending with step 5 then the first step test results will be found in location 3 not in location 1. Each parameter is separated by commas and includes step number, test type, test status, and metering. The syntax for this command response is {step, test type, status, meter 1, meter 2, meter 3}. ACW test displays 4 meters. Each meter will contain only the value and not the units. In the case of DCW current where both uA and mA are used on the display the command response will always indicate the current in uA for example 2.0mA will respond with 2000 for 2000uA.

### RR?

Read the remote Reset input signal. When the remote reset has been activated by closing the contacts the query will return a value of 1 to indicate the instrument is being Reset.

### RI?

Read the remote Interlock input signal. When the remote Interlock has been activated by opening the contacts the query will return a value of 0 to indicate the instrument is in the Interlock state and will not be able to generate output voltage or current.

**LF?**  
Lists the file name of the memory loaded into active memory (RAM).

**LFN?**  
Lists the memory number of the active memory file loaded into active memory (RAM).

**LF <memory number>?**  
List the file name of any of the 50 memories.

**LP?**  
Lists the prompt that is created for the selected step within active memory (RAM).

**LP <step number>?**  
Lists the prompt that has been created for a particular step of the file within active memory (RAM).

**LS?**  
Lists all the parameters for the individual step that is currently selected. See the ADD command for the list of parameters. A comma (,) will separate each parameter and will be preceded with the step number.

**LS <step number>?**  
Lists all the parameters for the individual step indicated by step number = 1-30. See the ADD command for the list of parameters. A comma (,) will separate each parameter and will be preceded with the step number.

## IEEE 488.2 Common Commands

These commands are required by the IEEE-488.2 standard with the exception of \*PSC, \*PSC?. Most of these commands are not available over the USB/RS-232 bus except for the \*IDN? command which can be used to retrieve the instrument identification information, and the four status reporting commands \*ESR?, \*ESE, \*ESE? and \*STB?

| COMMAND      | NAME                                 | VALUE  |
|--------------|--------------------------------------|--|
| *IDN?        | Identification Query                 | Associated Research Inc., Model Number, Serial Number, Firmware Revision           |
| *RST         | Reset Command                        | Resets HYAMP   |
| *TST?        | Self-Test Query                      | 00H=OK<br>01H=TEST EEPROM ERROR  |
| *CLS         | Clear Status Command                 | Clear Standard Event Status Register<br>Clear Service Request Register             |
| *OPC         | Operation Complete Command           | When all selected pending operations complete, ESR BIT0=1                          |
| *OPC?        | Operation Complete Query             | When all selected pending operations complete, Output Queue=1                      |
| *WAI         | Wait-to-Continue Command             |  |
| *PSC {1 0}   | Power-on Status Clear Command        | 1 = Power-on clear enable registers<br>0 = Power-on load previous enable registers |
| *PSC?        | Power-on Status Clear Query          |  |
| *ESR?        | Standard Event Status Register Query | 0 - 255  |
| *ESE <value> | Standard Event Status Enable Command | Value = 0 - 255  |
| *ESE?        | Standard Event Status Enable Query   | 0 - 255  |
| *STB?        | Read Status Byte Query               | Read Status Byte   |
| *SRE <value> | Service Request Enable Command       | Value = 0 - 255  |
| *SRE?        | Service Request Enable Query         | 0 - 255  |

**\*IDN?**

Read the instrument identification string. Company = Associated Research Inc.

**\*RST**

Reset the instrument to original power on configuration. Does not clear Enable register for Standard Summary Status or Standard Event Registers. Does not clear the output queue. Does not clear the power-on-status-clear flag.

**\*TST?**

Performs a self-test of the instrument data memory. Returns 0 if it is successful or 1 if the test fails.

**\*CLS**

Clears the Status Byte Summary register and Event registers. Does not clear the Enable registers.

**\*OPC**

Sets the operation complete bit (bit 0) in the Standard Event register after a command is completed successfully.

**\*OPC?**

Returns an ASCII "1" after the command is executed.

**\*WAI**

After the command is executed, it prevents the instrument from executing any further query or commands until the no-operation-pending flag is TRUE.

**\*PSC {1|0}**

Sets the power-on status clear bit. When set to 1 the Standard Event Enable register and Status Byte Enable registers will be cleared when power is turned ON. 0 setting indicates the Enable registers will be loaded with Enable register masks from non-volatile memory at power ON.

**\*PSC?**

Queries the power-on status clear setting. Returns 0 or 1.

**\*ESR?**

Queries the Standard Event register. Returns the decimal value of the binary-weighted sum of bits.

**\*ESE <value>**

Standard Event Enable register controls which bits will be logically OR'd together to generate the Event Summary bit 5 (ESB) within the Status Byte.

**\*ESE?**

Queries the Standard Event enable register. Returns the decimal value of the binary-weighted sum of bits.

**\*STB?**

Read the Status Byte. Returns the decimal value of the binary-weighted sum of bits.

**\*SRE <value>**

Service Request Enable register controls which bits from the Status Byte should be used to generate a service request when the bit value = 1.

**\*SRE?**

Queries the Service Request enable register. Returns the decimal value of binary-weighted sum of bits.



## Status Reporting

The status reporting system is configured using two types of registers. An Event register and a Summary register. The Summary register is known as the Status Byte register and records high-level summary information acquired by the Event registers.

An Event register report defines conditions or messages at each bit. The bits are latched and remain at an active state until the register is either Read or Cleared. Reading the Event register automatically clears the register and sets all bits to inactive state or 0. When querying an Event register the information is returned as a decimal number representing the binary-weighted sum of all bits within the register.

The Enable registers bits represent the selection of bits that will be logically OR'd together to form the summary bit in the Status Byte. The \*CLS command will not clear the Enable registers and if you wish to clear the register you must set it to a value of 0. Like the Event register, the enable register is represented as a decimal number that equals the binary-weighted sum of all bits.

The Enable register will clear to value a of 0 at power up unless the \*PSC 0 command had been executed before power-off. The \*PSC command tells the device whether or not it should clear the Enable registers at power-on. Using this command will allow SQRs to function immediately after power-on.

| Bit | Binary Weight |
|-----|---------------|
| 0   | 1             |
| 1   | 2             |
| 2   | 4             |
| 3   | 8             |
| 4   | 16            |
| 5   | 32            |
| 6   | 64            |
| 7   | 128           |

| EVENT REGISTER     |                 |
|--------------------|-----------------|
| Event Register     | Enable Register |
| Operation Complete |                 |
| not used           |                 |
| Query Error        |                 |
| Device Error       |                 |
| Execution Error    |                 |
| Command Error      |                 |
| not used           |                 |
| Power On           |                 |

\*ESR?

\*ESE  
\*ESE?

| EVESTATUS BYTE REGISTER                              |                 |
|--|-----------------|
| Summary Register                                     | Enable Register |
| ALL PASS   |                 |
| FAIL   |                 |
| ABORT  |                 |
| TEST IN PROCESS                                      |                 |
| Message Available (MAV)                              |                 |
| Event Summary Bit (ESB)                              |                 |
| Request Service (RQS) or Master Summary Status (MSS) | not used        |
| PROMPT   |                 |

\*STB? | SPOLL

\*SRE  
\*SRE?

# Appendix E - Replacement Parts List

| PART NUMBER                 | QTY. | REF. DESIGNATOR | DESCRIPTION                  |
|-----------------------------|------|-----------------|------------------------------|
| <b>Supplied Accessories</b> |      |                 |                              |
| 38503                       | 2    | —               | Fuse 10A 20mm                |
| 38489                       | 1    | —               | Cable HC Current 2WIRE 40A   |
| 38490                       | 1    | —               | Cable HC Return 2WIRE 40A    |
| 38075                       | 1    | —               | Interlock Connector          |
| 33189                       | 1    | —               | Cable Input Cordset USA      |
| 39066                       | 1    | —               | USB Cable AB Type 1.8m       |
| 39681                       | 1    | —               | LCD Protective Film          |
| 38482                       | 1    | —               | Adapter BOX (optional)       |
| <b>Panel Components</b>     |      |                 |                              |
| 35999                       | 2    | —               | Black Banana Jacks           |
| 36000                       | 2    | —               | Red Banana Jacks             |
| 38487                       | 2    | —               | Socket High Current Red      |
| 38488                       | 2    | —               | Socket High Current Black    |
| 40004                       | 1    | —               | Test Switch Green            |
| 40005                       | 1    | —               | Reset Switch Red             |
| 40056                       | 1    | —               | Power Switch 4A/250V         |
| 39572                       | 1    | —               | Display LCD Touch 480x272    |
| 37571                       | 1    | —               | Earth Connector              |
| 38102                       | 2    | —               | Rubber Insert for Front Feet |
| 40000                       | 2    | —               | Rubber Insert for Rear Feet  |
| 40001                       | 1    | —               | Feet Kit w/o Rubber Inserts  |
| 40057                       | 1    | —               | 24VDC Fan                    |
| 39575                       | 1    | —               | Fan Grill                    |

Continued on next page →

# Appendix E - Replacement Parts List continued

| PART NUMBER                | QTY. | REF. DESIGNATOR | DESCRIPTION        |
|----------------------------|------|-----------------|--------------------|
| <b>PCB Assemblies</b>      |      |                 |                    |
| 39982                      | 1    | CONSG7100       | Main Control Board |
| 39981                      | 1    | AMPSJ7314       | Amplifier Board    |
| 39983                      | 1    | FLYSJ7314       | FLY Back Board     |
| 39961                      | 1    | KEYSG7100       | Keypad Board       |
| 39963                      | 1    | USBSG7100       | USB Board          |
| 40011                      | 1    | LED01           | LED Board          |
| <b>Internal Components</b> |      |                 |                    |
| 39907                      | 1    | CR2032 ASSY     | Lithium Battery    |

# Appendix F – Calibration Procedure

## DID YOU KNOW?

This instrument has been fully calibrated at the factory in accordance to our published specifications and with standards traceable to the National Institute of Standards & Technology (NIST).

You will find in this manual a copy of the “Certificate of Calibration”. It is recommended that you have this instrument recertified at least once per year. Associated Research recommends you use “Calibration Standards” that are NIST traceable or traceable to agencies recognized by NIST to keep this instrument within published specifications. Unless necessary, do not recalibrate the instrument within the first 12 months.

End user metrology standards or practices may vary. These metrology standards determine the measurement uncertainty ratio of the calibration standards being used. Calibration adjustments can only be made in the Calibration mode and calibration checks or verifications can only be made while operating in Test mode.

**NOTE: Verification should be performed before and after calibration. Calibration effects will only be noticeable after exiting calibration mode.**

## Warranty Requirements

Associated Research offers a standard three year manufacturer’s warranty. This warranty can be extended an additional five years provided that the instrument is returned each year to Associated Research for its annual recertification. In order to be eligible for the extended warranty instruments must be returned to Associated Research for certification service at least once every twelve months.

A return material authorization number (RMA) must be obtained from Associated Research before returning this instrument for calibration. To obtain an RMA number or for information regarding our warranty, please contact our customer support representatives at 1-800-858-TEST (8378) or setup an RMA online at <http://www.arisafety.com/support/rma-request/>

## Required Calibration Equipment

- A Standard AC/DC Ammeter with minimum 40A range
- A standard AC/DC Voltmeter with minimum 10V Range

## Calibration Initialization

Press and hold the calibration key on the rear panel with a pen, pencil, or small screwdriver while powering ON the HYAMP. The HYAMP enters calibration mode after the power on sequence is complete. When the calibration is initialized the calibration screen will display each calibration point and appear as follows:

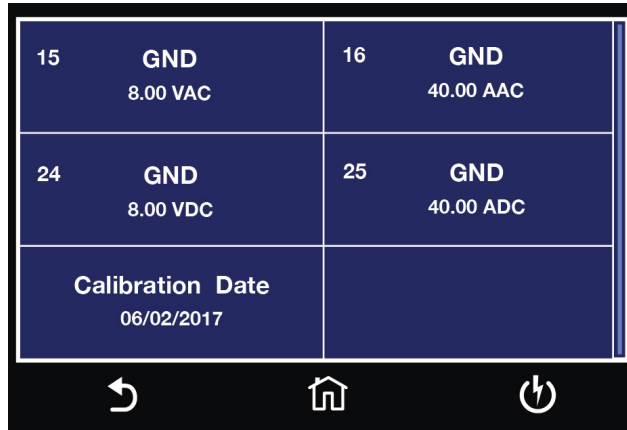

|                                |                 |    |                  |
|--------------------------------|-----------------|----|------------------|
| 15                             | GND<br>8.00 VAC | 16 | GND<br>40.00 AAC |
| 24                             | GND<br>8.00 VDC | 25 | GND<br>40.00 ADC |
| Calibration Date<br>06/02/2017 |                 |    |                  |

From the Calibration screens, use the touchscreen to select the parameter you wish to calibrate. A calibration prompt screen will now appear that describes the necessary load and connection information for the parameter being calibrated.

Once you press TEST, the Calibration data entry screen will appear for the selected parameter. Read the measurement from your standard and enter it using the numeric keypad. Once a value is entered the screen for the next step will appear.

### Calibration of AC Ground Bond Voltage

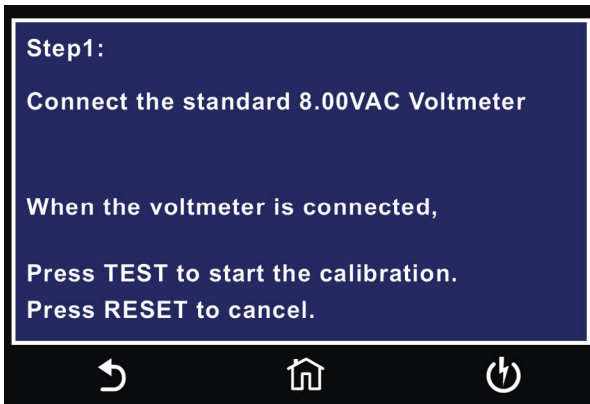

Follow on-screen instructions to complete Step 1.

### Calibration of AC Ground Bond Current

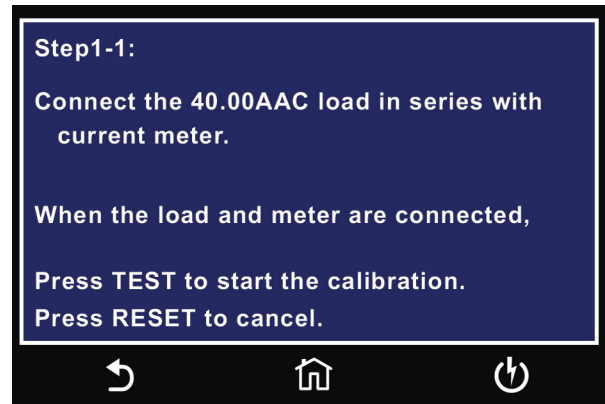

Follow on-screen instructions to complete Step 1-1.

### Calibration of DC Ground Bond Voltage

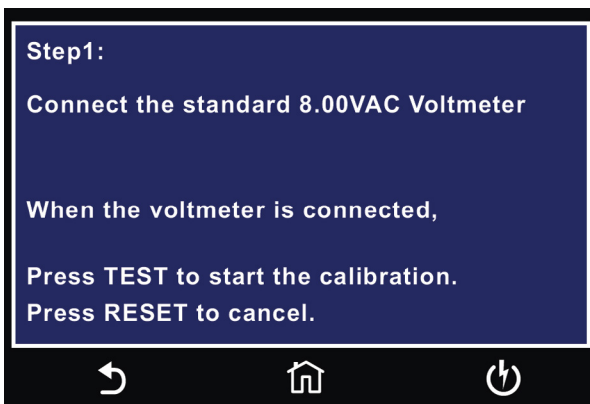

Follow on-screen instructions to complete Step 1.

### Calibration of DC Ground Bond Current

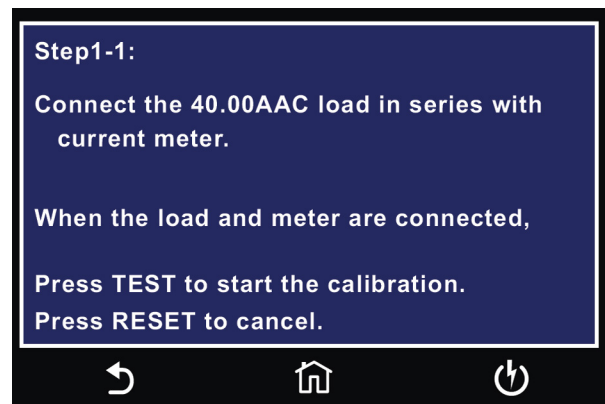

Follow on-screen instructions to complete Step 1-1.