



OPERATION AND SERVICE MANUAL

OMNIA II models 8204/8254
OMNIA II models 8206/8256
OMNIA II models 8207/8257
Electrical Safety Compliance Analyzer

AC/DC HIPOT WITH INSULATION RESISTANCE TESTER, GROUND BOND, AND CONTINUITY TESTER

825x INCLUDES 500VA OUTPUT CAPABILITY
82x6 INCLUDES RUN TEST AND LEAKAGE CURRENT TEST
82x7 INCLUDES 500VA AC POWER SOURCE

SERIAL NUMBER

--	--	--	--	--	--	--

Item 39334 Ver 3.22

September 1st, 2021



*Select models only.
See specs for details.

Associated Research

28105 North Keith Drive - Lake Forest, IL 60045 USA

T. 1-847-367-4077 F. 1-847-367-4080

info@arisafety.com www.arisafety.com



DECLARATION OF CONFORMITY

Manufacturer: Associated Research, Inc.
Address: 28105 North Keith Dr.
Lake Forest, IL 60045 USA
Product Name: OMNIA II® Electrical Safety Compliance Analyzer
Model Number: 8204/8254/8206/8256/8207/8257

Conforms to the following Standards:

Safety: EN 61010-1:2010
EN 61010-2-030:2010
EN 61010-031:2002+A1
UL 61010-1:2012, UL 61010-2-030:2012
CAN/CSA-C22.2 NO. 61010-1-12
CAN/CSA-C22.2 NO. 61010-2-030-12

EMC: EN 61326-1:2013 Class A,
EN 55011 :2009+A2:2010 Group 1 Class A,
EN 61000-3-2:2014, IEC 61000-3-2 :2014,
EN 61000-3-3:2013, IEC 61000-3-3 :2013,
EN 61326-1:2013 (Industrial Locations),
EN 61000-4-2:2009, IEC 61000-4-2:2008,
EN 61000-4-3:2006+A1:2008+A2:2010,
IEC 61000-4-3:2006+A1:2007+A2:2010,
EN 61000-4-4:2012, IEC 61000-4-4:2012,
EN 61000-4-5:2006, IEC 61000-4-5:2005
EN 61000-4-6:2014, IEC 61000-4-6:2013,
EN 61000-4-8:2010, IEC 61000-4-8:2009,
EN 61000-4-11:2004, IEC 61000-4-11:2004

Supplementary Information

*The product herewith complies with the requirements of the **Low Voltage Directive 2014/35/EU**, the **EMC Directive 2014/30/EU** and the **RoHS Directive 2015/863/EU** with respect to the following substances: Lead (Pb), Mercury (Hg), Cadmium (Cd), Hexavalent chromium (Cr (VI)), Polybrominated biphenyls (PBB), Polybrominated diphenyl ethers (PBDE), Bis phthalate (DEHP), Dibutyl phthalate (DBP), Benzyl butyl phthalate (BBP), Diisobutyl phthalate (DIBP), Deca-BDE included.*

Last two digits of the year in which the CE marking was affixed: 12

The technical file and other documentation are on file with Associated Research, Inc.



Joseph Guerriero, President
Associated Research, Inc.
Lake Forest, Illinois USA
July 20, 2017

TABLE OF CONTENTS

1. INTRODUCTION	1
1.1. Warranty Policies.....	1
1.2. Safety Symbols.....	3
1.2.1. Product Marking Symbols.....	3
1.2.2. Caution and Warning Symbols	3
1.3. Glossary of Terms	3
1.4. Safety	5
1.4.1. Service and Maintenance	5
1.4.2. Test Operator.....	6
1.5. Key Features of OMNIA II.....	8
2. GETTING STARTED	9
2.1. Unpacking and Inspection.....	9
2.1.1. Packaging.....	9
2.1.2. Contents of the Carton	9
2.2. Installation.....	11
2.2.1. Work Area.....	11
2.2.2. Power Requirements	11
2.2.3. Basic Connections	11
2.2.4. Environmental Conditions.....	12
3. SPECIFICATIONS AND CONTROLS.....	14
3.1. OMNIA II Functional Specifications.....	14
3.2. Instrument Controls.....	27
3.2.1. Front Panel Controls.....	27
3.2.2. Rear Panel Controls	29
3.2.3. Additional Rear Panel Controls.....	30
4. PROGRAMMING INSTRUCTIONS	32
4.1. Power Up	32
4.2. Setup System.....	32
4.2.1. Setup System Keys	33
4.2.2. Time and Date	33
4.2.3. Calibration Alert.....	36
4.2.4. Hardware	38
4.2.5. Security.....	41
4.2.6. Power-On Screen.....	50
4.3. Setup Tests Menu	52
4.3.1. Add	53
4.3.2. Edit.....	54
4.3.3. Delete.....	54
4.3.4. Prompt.....	55
4.3.5. File.....	56

4.3.6. Fail Stop.....	57
4.4. Test Parameters	58
4.4.1. Description of Test Parameters	58
4.4.2. Default Parameters	62
4.5. Setting Up a Test.....	65
4.5.1. AC Withstand.....	68
4.5.2. DC Withstand.....	69
4.5.3. Insulation Resistance	71
4.5.4. Continuity.....	72
4.5.5. AC Ground Bond.....	72
4.5.6. Continuity.....	74
4.5.7. Functional Run Test (Model 82x6 and 82x7).....	75
4.5.8. Leakage Current test (Models 82x6 and 82x7)	78
4.6. Setting Up a Test.....	90
5. OPERATING INSTRUCTIONS.....	92
5.1. Instrument Connections	92
5.1.1. Connecting the Test Leads.....	92
5.1.2. Adapter Box Connections	92
5.1.3. Interlock Connector.....	93
5.1.4. DUT Input Voltage Connections for Models 82x6 and 82x7	93
5.1.5. Scanner Connections	94
5.2. Perform Tests Menu	95
5.2.1. Load File.....	95
5.2.2. Single Step.....	96
5.2.3. Fail Stop.....	96
5.2.4. Results	97
5.3. Performing a Test.....	98
5.4. Perform Tests Metering.....	100
5.5. Displayed Messages.....	100
5.5.1. Test Status Messages (all Models)	101
5.5.2. Error Messages (All Models).....	103
5.5.3. Error Messages (Models 82x6 and 82x7)	103
6. CONNECTION OF REMOTE I/O.....	106
6.1. Remote Signal Outputs	106
6.2. Remote Signal Inputs and Memory Access	107
7. BUS REMOTE INTERFACE USB / GPIB / RS-232	110
7.1. USB/RS-232 Interface	110
7.1.1. RS-232 Connector	110
7.1.2. Communications Port Configuration	110
7.1.3. Sending and Receiving Commands.....	111
7.2. GPIB Interface	111
7.2.1. GPIB Connector	111

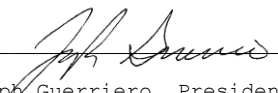
7.2.2. GPIB Address	112
7.3. Interface Functions.....	112
7.4. USB / RS-232 / GPIB Interface Command List	113
7.4.1. Echo and Response Considerations.....	113
7.4.2. Test Execution Commands	113
7.4.3. File Editing Commands	114
7.4.4. Test Parameter Editing Commands and Companion Queries ..	122
7.4.5. Query Commands.....	128
7.4.6. IEEE 488.2 Common Commands	130
7.4.7. Status Reporting.....	132
7.4.8. GPIB Service Request	134
7.5. Non Volatile Memory.....	134
8. OPTIONS.....	138
9. FAILCHEK.....	192
9.1. FailCHEK Menu	192
9.1.1. Continuity Verification.....	192
9.1.2. Ground Bond Verification.....	194
9.1.3. AC Hipot Verification	196
9.1.4. DC Hipot Verification	197
9.1.5. IR Verification	199
10. CALIBRATION PROCEDURE	201
10.1. Warranty Requirements	201
10.2. Hardware Calibration.....	202
10.3. Calibration Initialization	202
10.4. Selecting Specific Calibration points	203
10.5. Calibration points.....	203
10.5.1. Calibration of AC Hipot Voltage.....	204
10.5.2. Calibration of DC Hipot Voltage.....	204
10.5.3. Calibration of IR DC Voltage.....	204
10.5.4. Calibration of AC 40mA Range	205
10.5.5. Calibration of AC 3.5mA Range	205
10.5.6. Calibration of DC 20mA Range	205
10.5.7. Calibration of DC 3.5mA Range	206
10.5.8. Calibration of DC 350.0 μ A Range.....	206
10.5.9. Calibration of IR 999.99M Range.....	207
10.5.10. Calibration of IR 999.9M Range.....	207
10.5.11. Calibration of IR 50000M Range.....	207
10.5.12. Calibration of Smart GFI.....	208
10.5.13. Calibration of GND Bond Voltage	208
10.5.14. Calibration of GND Current.....	208
10.5.15. Calibration of Continuity	209
10.5.16. Calibration of Run Test Voltage	210
10.5.17. Calibration of Run Test Current.....	210
10.5.18. Calibration of Run Test Power.....	210

10.5.19. Calibration of Run Test Leakage.....	211
10.5.20. Calibration of LCT MD V-Offset.....	211
10.5.21. Calibration of LCT MD Volts DC x 0.1.....	212
10.5.22. Calibration of LCT MD Volts DC x 1.....	212
10.5.23. Calibration of LCT MD Volts DC x 4.....	212
10.5.24. Calibration of LCT MD Volts DC x 16.....	213
10.5.25. Calibration of LCT MD Volts DC x 64.....	213
10.5.26. Calibration of LCT MD Volts DC x 256.....	214
10.5.27. Calibration of LCT MD Volts AC x 0.1.....	214
10.5.28. Calibration of LCT MD Volts AC Peak x 0.1.....	214
10.5.29. Calibration of LCT MD Volts AC x 1.....	215
10.5.30. Calibration of LCT MD Volts AC Peak x1.....	215
10.5.31. Calibration of LCT MD Volts AC x 4.....	216
10.5.32. Calibration of LCT MD Volts AC Peak x 4.....	216
10.5.33. Calibration of LCT MD Volts AC x 16.....	216
10.5.34. Calibration of LCT MD Volts AC Peak x 16.....	217
10.5.35. Calibration of LCT MD Volts AC x 64.....	217
10.5.36. Calibration of LCT MD Volts AC Peak x 64.....	218
10.5.37. Calibration of LCT MD Volts AC x 256.....	218
10.5.38. Calibration of LCT MD Volts AC Peak x 256.....	218
10.5.39. Calibration of LCT MD: UL 544NP.....	219
10.5.40. Calibration of LCT MD: UL 544NP.....	219
10.5.41. Calibration of LCT MD: IEC60601-1 / UL2601.....	219
10.5.42. Calibration of LCT MD: UL 1563.....	220
10.5.43. Calibration of LCT MD: IEC 60990 Fig4-U2.....	220
10.5.44. Calibration of LCT MD: IEC 60990 Fig5-U3.....	221
10.5.45. Calibration of LCT MD: External.....	221
10.5.46. Calibration of LCT MD: IEC 60990 Fig4.....	221
10.5.47. Calibration of LCT MD: IEC60990 Fig5.....	222
10.5.48. AC Source Calibration Low Range 150VAC.....	222
10.5.49. AC Source Calibration High Range 277VAC.....	223
11. REPLACEMENT PARTS LIST.....	224
12. APPENDIX A EXTENDED 82x6/82x7 SPECIFICATIONS.....	226

Index is located at the back of the Manual.

1. INTRODUCTION

1.1. Warranty Policies

Ikonix Brand, certifies that the tester listed in this manual meets or exceeds published manufacturing specifications. This tester was calibrated using standards that are traceable to the National Institute of Standards and Technology (NIST).

Your new tester is warranted to be free from defects in workmanship and material for a period of (5) years from date of shipment. We aim to provide an amazing experience and quality testers that last a long time. If you're not satisfied with your tester, return it within 45 days for a full refund. Calibrate annually with us, or one of our authorized partners, and we'll extend your warranty an additional year for the service life of your tester, and at least five years after discontinuation. If it breaks during that time, we promise to fix it for free (unless abuse or excessive damage is present). When your tester reaches the end of its service life, we'll responsibly recycle it and give you a discount on a replacement. Annual calibration and inspection must be made in each successive year starting one year after the original purchase date in order to remain eligible for extended warranty coverage beyond the standard warranty period (five years).

Ikonix Brand recommends that your tester be calibrated on a twelve-month cycle. A return material authorization (RMA) must be obtained from Ikonix Brand. To obtain an RMA please contact our Customer Support team at 1-847-367-4077 or visit arisafety.com. Damages sustained as a result of improper packaging will not be honored. Transportation costs for the return of the tester for warranty service must be prepaid by the customer. Ikonix Brand will assume the return freight costs when returning the tester to the customer. The return method will be at the discretion of Ikonix Brand.

Except as provided, herein Ikonix Brand makes no warranties to the purchaser of this tester and all other warranties, expressed or implied (including, without limitation, merchantability or fitness for a particular purpose), are hereby excluded, disclaimed and waived.

Any non-authorized modifications, tampering or physical damage will void your warranty. Elimination of any connections in the earth grounding system or bypassing any safety systems will void this warranty. This warranty does not cover accessories not of Ikonix Brand manufacture. Parts used must be parts that are recommended by Ikonix Brand as an acceptable specified part. Use of non-authorized parts in the repair of this tester will void the warranty.

*5 year warranty is valid on any model purchased in 2021 or after.

****This Page Intentionally Left Blank****

1.2. Safety Symbols

1.2.1. Product Marking Symbols



Product will be marked with this symbol when it is necessary to refer to the operation and service manual in order to prevent injury or equipment damage.



Product will be marked with this symbol when hazardous voltages may be present.



Product will be marked with this symbol at connections that require earth grounding.

1.2.2. Caution and Warning Symbols



Calls attention to a procedure, practice, or condition that could possibly cause bodily injury or death.



Calls attention to a procedure, practice, or condition that could possibly cause damage to equipment or permanent loss of data.

1.3. Glossary of Terms

(As used in this manual)

Alternating Current, AC: Current that reverses direction on a regular basis. Utility power is usually generated in the form of a sinusoid at a frequency of 60 times per second in the United States and 50 times per second in other countries.

Arc: A partial momentary breakdown due to the force of a strong electric field on closely spaced conductors, sometimes evidenced by corona or a luminous flashover.

Breakdown: The failure of insulation to effectively prevent the flow of current. If the test voltage is gradually raised, breakdown will begin suddenly at a certain voltage level and current flow will not be directly proportional to voltage. Once a breakdown occurs, especially for a period of time, the next gradual application of voltage will often cause a breakdown to begin at a lower voltage.

Conductor: A solid or liquid material which permits the flow of electrons. A material which has a volume resistivity of no more than $10^3 \Omega\text{-cm}$.

Current: The movement of electrons through a conductor. Current is measured in amperes (A), milliamperes (mA), microamperes (uA). Symbol = I

Dielectric: An insulating material that is positioned between two conductive materials in such a way that a charge or voltage may appear across the two conductive materials.

Direct Current, DC: Current that flows in one direction only. The source of direct current is said to be polarized and has one terminal that is always at a higher potential than the other.

Frequency: The number of cycles an AC waveform repeats over time. Usually given in Hertz (Hz).

Ground: Refers to the point of low potential in a circuit to which all other voltages are referenced. May or may not be tied to the earth. Also referred to as Earth.

Hot: Used to refer to the test lead or output side of an instrument that is at high potential.

Impedance: The property of capacitive or inductive items to limit certain frequencies.

Insulation: Gas, liquid or solid material which has a volume resistivity of at least 10^{12} Ω -cm and is used for the purpose of restricting current flow between conductors.

Leakage: AC or DC current flow through insulation and over its surfaces. Current flow is directly proportional to voltage. The insulation is thought of as a constant impedance unless breakdown occurs.

Neutral: The point of low potential in a circuit to which all other voltages are referenced. Also known as Common.

Peak Current: The maximum amplitude of an AC current waveform. For a sinusoid, 1.414 x the RMS value.

Power: The amount of work performed by an energy source over time, given in Watts (W).

PF (Power factor): Power Factor = W/VA where W =Watts (Real Power) and VA =Volts x Amps (apparent power). It is important to note that the closer the power factor is to "1" the more resistive the DUT is. The closer the power factor is to 0 the more reactive (inductive or capacitive) the DUT is.

Reactive Current: The current component due to the reactive impedance of a load. Also called imaginary current.

Real Current: The current component due to the resistance of a load.

Resistance: The property of a substance that impedes current and results in the dissipation of power in the form of heat. The practical unit of resistance is the *ohm* (Ω). Symbol = **R**

Return: The path by which current returns to a source.

RMS: The Root Mean Squared value of a voltage or current waveform. An RMS waveform delivers the same amount of energy to a load as a DC waveform of the same value. For a sinusoid, the RMS value is .707 x the peak value.

Total Current: The vector sum of the real current component and the reactive current component produced by an applied voltage.

VA: A rating of instantaneous power found by multiplying an instrument's maximum output current by its maximum output voltage.

Voltage: The force which causes current through an electrical conductor, given in volts (V). Symbol = **V**

1.4. Safety

This product and its related documentation must be reviewed for familiarization with safety markings and instructions before operation.

This product is a Safety Class I instrument (provided with a protective earth terminal). Before applying power verify that the input voltage to the instrument is 115VAC±10% or 230VAC±10% and the correct fuse is installed.

This product carries an NRTL (Nationally Recognized Testing Laboratory) and comes equipped with an audible and visual failure indicator.

WARNING

The OMNIA produces voltages and currents that can cause **harmful or fatal electric shock**. To prevent accidental injury or death, these safety procedures must be strictly observed when handling and using the test instrument.

1.4.1. Service and Maintenance

User Service

To prevent electric shock do not remove the instrument cover. There are no internal user serviceable parts. Routine maintenance or cleaning of internal parts is not necessary. Avoid the use of cleaning agents or chemicals on the instrument, as some chemicals may damage plastic parts or lettering. Any external cleaning should be done with a clean, dry or slightly damp cloth. Schematics, when provided, are for reference only. Refer servicing and certification to an Associated Research, Inc. authorized service center.

SAFETY

This instrument meets UL requirements for audible and visual failure indication.

ASSOCIATED RESEARCH, INC.
13860 WEST LAUREL DRIVE
LAKE FOREST, IL 60045-4546 U.S.A.

PHONE: 1 (847) 367-4077
1 (800) 858-TEST (8378)
FAX: 1 (847) 367-4080
E-MAIL: info@asresearch.com

Service Interval

Associated Research, Inc. will not be held liable for injuries suffered if the instrument is not properly maintained and safety checked annually. See section **1.1. Warranty Policies** for more information.

1.4.2. Test Station

Location

Select an area away from the mainstream of activity where employees do not walk while performing their normal duties. If this is not practical because of production line flow, then the area should be roped off and marked for **HIGH VOLTAGE TESTING**. No employees other than test operators should be allowed inside.

If benches are placed back-to-back, be especially careful about the use of the bench opposite the test station. Signs should be posted: **“DANGER – HIGH VOLTAGE TEST IN PROGRESS – UNAUTHORIZED PERSONNEL KEEP AWAY.”**

Work Area

When possible, use the instrument on a non-conducting table or workbench. If you cannot avoid using a conductive surface, be certain that it is connected to a good earth ground and the high voltage connection is insulated from the grounded surface.

There should not be any metal in the work area between the operator and the location where products being tested will be positioned. Any other metal in the work area should be connected to a good ground, never left “floating”.

Keep the area clean and uncluttered. All test equipment and unnecessary test leads should be removed from the test bench and put away. It should be apparent to both the operator and to any observers which product is under test, which product is waiting to be tested and which product has already been tested.

Power

Power to the test station should be arranged so that it can be shut off by one prominently marked switch located at the entrance to the test area. In case of an emergency, anyone should be able to cut off the power before entering the test area to offer assistance.

More Information

For more information on setting up a safe work station, please visit the Events and Training section of our website at <http://www.asresearch.com/events-training/Default.aspx>

ESD TESTING

Electrical safety tests should not be performed in or around ESD testing areas. ESD methods should not be employed during electrical safety testing, as this could cause a hazardous condition for equipment and test operators.

1.4.3. Test Operator

WARNING

This instrument generates voltages and currents that can cause **harmful or fatal electric shock** and must only be operated by a skilled worker trained in its use. **The operator should understand the electrical fundamentals of voltage, current, and resistance.**

WARNING

Do not touch the device under test, high voltage test lead, alligator clip, or clip insulator once the test has been started.

WARNING

Do not touch the front panel when testing or after a malfunction has occurred.

Rules

Operators should be thoroughly trained to follow all national safety standard guidelines for electrical safety testing in the workplace. Defeating any safety system should be considered a serious offense with severe penalties. Allowing unauthorized personnel in the area during a test should also be dealt with as a serious offense. Test operators should be familiar with methods to properly discharge a device under test in case test leads become disconnected during testing.

Refer to the following standards for more information:

- NFPA 70E
- OSHA 1910 subpart (S)
- EN50191

Dress

Operators should not wear jewelry that could accidentally complete a circuit.

WARNING

ESD protocols should not be observed while performing electrical safety tests. Intentionally grounding the test operator could lead to a **harmful or fatal electric shock**.

Medical Restrictions

Personnel with heart ailments or devices such as pacemakers should be informed that the voltages and currents generated by the instrument are very dangerous. If contacted, the instrument may cause heart-related problems.

Please have the test operator consult a physician for recommendations.

KEY SAFETY POINTS TO REMEMBER

- Keep unqualified and unauthorized personnel away from the test area.
- Arrange the test station in a safe and orderly manner.
- In case of any problem, turn off the high voltage first.

1.5. Key Features of OMNIA II

COLOR TFT DISPLAY	800 x 480 color TFT display (30% larger than the OMNIA 1 series) makes setting up test files, viewing results and performing tests easier than ever. Color coded test steps clearly indicate pass/fail conditions. Choose from 4 color schemes.
MY MENU INTERFACE	Personalize menu settings with the My Menu interface. Create shortcuts to your favorite screens and preferences.
DUAL CHEK™	Perform simultaneous hipot and ground bond tests.
MULTIPLE LANGUAGE SETTINGS	View the menu in English or Chinese.
EXPANDED TEST MEMORIES	Users can link a total of 10,000 test steps in any configuration.
PATENTED SMART GFI™	SmartGFI™ disables the instrument's output voltage in less than 1 millisecond if excessive leakage to ground is detected. If enabled, SmartGFI™ automatically detects if the DUT is floating or grounding and turns ON or OFF accordingly. SmartGFI trip current value adjustable from 0.4 – 5.0mA.
FOUR WIRE MEASUREMENT (KELVIN METHOD) AND MILLIOHM OFFSET CAPABILITY IN THE GROUND BOND MODE	The four-wire measurement technique factors out test lead resistance, making measurements more accurate. The Milliohm Offset features allows the operator to factor out additional lead and fixture resistance.
FAILCHEK™	Allows the operator to self-verify the instrument's failure detectors.
500VA OUTPUT CAPABILITY	OMNIA II is now available with 500VA output capability for AC hipot testing. Models 825x include this feature.
BUILT-IN AC POWER SOURCE	OMNIA II models 8207/8257 come standard with a 500VA AC power source for use with RUN and LCT tests.

2. GETTING STARTED

Introduction

This section contains information for the unpacking, inspection, preparation for use and storage of your Associated Research, Inc., product.

2.1. Unpacking and Inspection

2.1.1. Packaging

Your instrument was shipped in a custom foam insulated container. If the shipping carton is damaged, inspect the contents for visible damage such as dents, scratches or a broken display. If the instrument is damaged, notify the carrier and Associated Research, Inc.'s customer support department. **Please save the shipping carton and packing material for the carrier's inspection.** Our customer support department will assist you in the repair or replacement of your instrument. Please do not return your product without first notifying us and receiving an RMA (return material authorization) number. To receive an RMA number, please contact our customer support department at 1-800-858-TEST (8378).

Safe Lifting and Carrying Instructions

Proper methods of lifting and carrying can help to protect against injury. Follow the recommendations below to ensure that instruments are handled in a safe manner.

- Determine if the instrument can be lifted by one individual or requires additional support.
- Make sure that your balance is centered and your feet are properly spaced, shoulder width apart behind the instrument.
- Bend at the knees and make sure your back is straight.
- Grip the instrument with your fingers and palms and do not lift unless your back is straight.
- Lift up with your legs, not your back.
- Keep the instrument close to your body while carrying.
- Lower the instrument by bending your knees. Keep you back straight.

2.1.2. Contents of the Carton

Inside the carton should be the following:

DESCRIPTION	AR PART NUMBER
OMNIA Instrument	8204, 8254, 8206, 8256, 8207, 8257
High Voltage Cable	04040A-08 (3 for 82x6 and 82x7)
High Current Output Cable	38489
High Current Return Cable	38490
High Current Test Lead	CBLHC40-10TL (82x6 and 82x7)
Fuse	38503, 10A Slow-Blow 250VAC
USB Cable AB-Type 1.8m	39066
Line Cord*	33189 Standard
Line Cord	39368 (82x6 and 82x7)
Adapter Box*	38482 Standard (82x4)
Adapter Box*	38578 (82x6 and 82x7)
Bracket Rack Mount 3U (Qty 2)	38788
Handle Rack Mount 3U (Qty 2)	38787
Screw M4 x 12mm FHMS (Qty 4)	38549 For Rack Mount Handle

- **NOTE:** The Adapter Box (universal US polarity) and line cord listed are American. Other combinations of line cord and Adapter Box are available upon request.

WARNING

Only accessories which meet the manufacturer's specification shall be used.



2.2. Installation

2.2.1. Work Area

WARNING

Locate a suitable testing area and be sure you have read all safety instructions for the operation of the instrument and suggestions on the test area setup in section **1.4. Safety**. Make sure the work area you choose has a three-prong grounded outlet capable of supplying the necessary input current to the power source. Be sure the outlet has been tested for proper wiring before connecting the instrument to it.

WARNING

The mains plug is used as the disconnecting device and shall remain readily operable. The socket-outlet shall be installed near the equipment and shall be easily accessible.

2.2.2. Power Requirements

This instrument requires a power source of either 115 volts AC $\pm 10\%$, 50/60 Hz single phase or 230 volts AC $\pm 10\%$, 50/60 Hz single phase. This instrument auto-ranges for 115 / 230V, $\pm 15\%$ variation. See section **3.2.2. Rear Panel Controls** for an image of the rear panel. OMNIA II maximum rated power is 750VA.

CAUTION

Do not replace the power supply cord with an improperly rated cord. For North American: A UL listed and CSA labeled power cord must be used with the instrument in the United States and Canada. The power cord must include a NEMA5-15 style male plug, SVT or SJT cord sets, and be rated for at least 125VAC, 10A, number 16 gauge (or 125VAC, 15A, number 14 gauge) wire or larger, and the length of the cord does not exceed 2 m must be used. For European: A certified power supply cord not lighter than light PVC sheathed flexible cord according to IEC 60227, designation H03 VV-F or H03 VVH2-F (for equipment mass not exceeding 3 kg), or H05 VV-F or H05 VVH2-F2 (for equipment mass exceeding 3 kg), and be rated for at least 3G 0.75 mm² (for rated current up to 10 A) or 3G 1.0mm² (for rated current over 10 A up to 16 A) wire or larger, and the length of the cord does not exceed 2 m must be used.

CAUTION

Do not switch the line voltage selector switch located on the rear panel while the instrument is on or operating. This may cause internal damage and represents a safety risk to the operator.

WARNING

The OMNIA II must be connected to a good ground. Be certain that the power wiring is properly polarized and that the proper low resistance bonding to ground is in place.

2.2.3. Basic Connections

Power Cable

The instrument is shipped with a line cord containing a protective earth ground. When the line cord is connected to an appropriate AC power source the cable will connect the chassis to earth ground.



The main plug shall only be inserted in a socket outlet with a protective ground (earth) contact. This protective ground **must not be defeated** by the use of an extension cord without a protective conductor.

Return Connection

When the instrument's return is grounded, any internal and external stray leakage will be monitored due to currents that flow from high voltage to earth ground (such as from high voltage to the chassis of the instrument). These currents are inherent and will cause errors when trying to monitor very low leakage currents in the microamp range.

The output power supplies of this instrument are referenced directly to earth ground. Any conductor that completes a path between the high voltage and earth ground will form a completed circuit.

2.2.4. Environmental Conditions

This equipment is intended for indoor use only. The equipment has been evaluated according to Installation Category II and Pollution Degree 2 as specified in IEC 664.

This instrument may be operated in environments with the following limits:

Temperature..... 41° - 104° F (5° - 40°C)
Relative humidity..... 0 – 80%
Altitude..... 6560 feet (2,000 meters)



Keep the ventilation slits uncovered during operation. Failure to do so could cause the instrument to overheat and may damage internal components.

Storage and Shipping Environment

This instrument may be stored or shipped in environments with the following limits:

Temperature..... -40° - 167° F (-40° - 75°C)
Altitude..... 50,000 feet (15,240 meters)

The instrument should also be protected against temperature extremes that may cause condensation within the instrument.



Failure to operate this instrument within the specified conditions could result in damage.

If the instrument is used in a matter not specified by the manufacturer, the protection provided by the instrument may be impaired.

More Information

For more information on test operator and workstation safety please visit the Events and Training section of our website at <http://www.asresearch.com/events-training/Default.aspx>

3. SPECIFICATIONS AND CONTROLS

3.1. OMNIA II Functional Specifications

INPUT	
Voltage	115 / 230V auto-range, $\pm 15\%$ variation
Frequency	50/60 Hz $\pm 5\%$
Fuse	115 VAC, 230VAC – 10A Slow-Blo 250VAC
DIELECTRIC WITHSTAND TEST MODE	
Output Rating	5KV @ 50mA AC 5KV @ 100mA AC (Models 825x) 6KV @ 20 mA DC
Voltage Setting	Range: 0–5000V AC 0–6000V DC Resolution: 1 V Accuracy: $\pm (2\% \text{ of setting} + 5 \text{ volts})$
Voltage Display	Range: 0.00 – 6.00KV Full Scale Resolution: 0.01 KV Accuracy: $\pm (2\% \text{ of reading} + 1 \text{ count})$
Ramp-HI DC	>20 mA peak maximum, ON/OFF Selectable
Charge-LO DC	Range: 0.0 – 350.0 μA DC or Auto set
HI and LO-Limit	
AC Total	Range: 0.000 – 9.999mA Resolution: 0.001mA Range: 10.00 – 50.00mA (100.00mA, Models 825x) Resolution: 0.01mA Accuracy: $\pm (2\% \text{ of setting} + 2 \text{ counts})$
AC Real	Range: 0.000 – 9.999mA Resolution: 0.001mA Range: 10.00 – 50.00mA (99.99mA, Models 825x) Resolution: 0.01mA Accuracy: $\pm (3\% \text{ of setting} + 50 \mu\text{A})$
DC	Range: 0.0 – 999.9 μA Resolution: 0.1 μA Range: 1000 – 20000 μA Resolution: 1 μA Accuracy: $\pm (2\% \text{ of setting} + 2 \text{ counts})$
Arc Detection	Range: 1 – 9
Ground Continuity	Current : DC 0.1 A $\pm 0.01\text{A}$, fixed Max. ground resistance : 1 $\Omega \pm 0.1\Omega$, fixed
Ground Fault Interrupt	GFI Trip Current: 0.4mA - 5.0mA (AC or DC) HV Shut Down Speed: < 1mS

DIELECTRIC WITHSTAND TEST MODE (CONT.)		
Current Display	Auto Range*	
AC Total	Range 1: 0.000 mA – 3.500 mA RMS (0.000 mA – 5.500 mA Peak) Resolution: 0.001 mA	
AC Real	Range 2: 3.00 mA – 50.00 mA RMS (5.00 mA – 70.07 mA Peak) Resolution: 0.01 mA Accuracy: ± (2% of reading + 2 counts) All Ranges	
DC	Range 1: 0.000 mA – 9.999 mA Resolution: 0.001 mA Range 2: 10.00 mA – 50.00 mA Resolution: 0.01 mA Accuracy: ± (3% of reading + 50µA) All Ranges PF > 0.1 V > 250VAC	
	Range 1: 0.0 µA – 350.0 µA DC (0.0 µA – 550.0 µA Peak) Resolution: 0.1 µA	
	Range 2: 0.300 mA – 3.500 mA DC (0.400 mA – 5.500 mA Peak) Resolution: 0.001 mA	
	Range 3: 3.00 mA – 20.00 mA DC (4.00 mA – 25.00 mA Peak) Resolution: 0.01 mA Accuracy: ± (2% of reading + 2 counts) All Ranges	
DC Output Ripple	≤ 4% Ripple RMS at 5 KV DC @ 20mA, Resistive Load	
Discharge Time	≤ 50 ms no load, < 100 ms for capacitive load	
Maximum Capacitive Load	1µF < 1KV 0.75µF < 2KV	0.08µF < 4KV 0.04µF < 6KV
DC Mode	0.5µF < 3KV	
AC Output Waveform	Sine Wave, Crest Factor = 1.3 – 1.5	
Output Frequency	Range: 60 or 50 Hz, User Selection Accuracy: ± 0.1 %	
Output Regulation	± (1 % of output + 5 V) from no load to full load and over input voltage range.	
Dwell Timer	Range: AC 0.4 –999.9 sec (0 = Continuous) Range: DC 0.3 –999.9 sec (0 = Continuous) Resolution: 0.1 sec Accuracy: ± (0.1% + 0.05 sec)	
Ramp Timer	Range: Ramp-Up: AC 0.1 – 999.9 sec DC 0.4 – 999.9 sec Ramp-Down: AC 0.0 – 999.9 sec DC 0.0 , 1.0 – 999.9 sec Resolution: 0.1 sec	

	Accuracy: $\pm (0.1\% + 0.05 \text{ sec})$
Short Circuit Protection	Minimum current 100mA peak (200mA, Models 825x) at short circuit, response time < 2ms

*Autorange operation:

Ranges up to higher range when Peak **OR** RMS values are greater than range maximum

Ranges down to lower range when Peak **AND** RMS values are less than range minimum

INSULATION RESISTANCE TEST MODE			
Voltage Setting	Range:	30 – 1000 VDC	
	Resolution:	1 V	
	Accuracy:	± (2% of setting + 2 counts)	
Charging Current	Maximum	>20mA peak	
Voltage Display	Range:	0 – 1000 V	
	Resolution:	1 V	
	Accuracy:	± (2% of reading + 2 counts)	
Resistance Display	Range:	0.05MΩ – 50000 MΩ (4 Digit, Auto Ranging)	
	Resolution:	30 – 499 VDC	500 – 1000VDC
	MΩ	MΩ	MΩ
	0.001	0.050 – 1.999	0.050 – 9.999
	0.01	2.00 – 19.99	10.00 – 99.99
	0.1	20.0 – 199.9	100.0 – 999.9
	1	200 – 50000	1000 – 50000
	Accuracy:	50 – 499V 0.05M – 999.9M, ± (7% of reading +2 counts)	
	500 – 1000V 0.05M – 999.9M, ± (2% of reading +2 counts) 1000M – 9999M ± (5% of reading +2 counts) 10000M – 50000M, ± (15% of reading +2 counts)		
Charge-LO	Range:	0.000 – 3.500μA or Auto Set	
HI and LO–Limit	Range:	0.05M – 99.99MΩ	
	Resolution:	0.01M	
	Range:	100.0M – 999.9M	
	Resolution:	0.1M	
	Range:	1000M – 50000M	
	Resolution:	1M	
	(HI – Limit: 0 = OFF)		
	Accuracy: Same as Resistance Display Accuracy		
Ramp Timer	Range:	Ramp-Up:	0.1 – 999.9 sec
		Ramp-Down:	0.0, 1.0–999.9 sec
	Resolution:	0.1 sec	
	Accuracy:	± (0.1% + 0.05 sec)	
Delay Timer	Range:	0.5 – 999.9 sec (0 = Continuous)	
	Resolution:	0.1 sec	
	Accuracy:	± (0.1% + 0.05 sec)	
Ground Fault Interrupt	GFI Trip Current:	0.4mA - 5.0mA	
	HV Shut Down Speed:	< 1mS	

GROUND BOND TEST MODE	
Output Voltage (Open Circuit Limit)	Range: 3.00 – 8.00 VAC Resolution: 0.01 V Accuracy: \pm (2 % of setting + 0.03V) O.C. Condition
Output Frequency	Range: 60 or 50 Hz, user selectable Accuracy: \pm 0.1%
Output Current	Range: 1.00 – 40.00 A Resolution: 0.01 A Accuracy: \pm (2 % of setting + 0.02 A)
Output Regulation	Accuracy: \pm (1% of output + 0.02A) Within maximum load limits, and over input voltage range.
Maximum Loading	1.00 – 10.00A, 0 – 600m Ω 10.01 – 30.00A, 0 – 200m Ω 30.01 – 40.00A, 0 – 150m Ω
Current Display	Range: 0.00 – 40.00 A Resolution: 0.01 A Accuracy: \pm (3 % of setting + 0.03 A)
HI and LO-Limits	Range: 0 – 150 m Ω for 30.01 – 40.00 Amps 0 – 200 m Ω for 10.01 – 30.00 Amps 0 – 600 m Ω for 1.00 – 10.00 Amps Resolution: 1 m Ω Accuracy: Same as Ohmmeter Display
Ohmmeter Display	Range: 0 – 150 m Ω for 30.01 – 40.00 Amps 0 – 200 m Ω for 10.01 – 30.00 Amps 0 – 600 m Ω for 6.00 – 10.00 Amps Resolution: 1 m Ω Accuracy: \pm (2% of reading + 2 m Ω)
	Range: 0 – 600 m Ω for 1.00 – 5.99 Amps Resolution: 1 m Ω Accuracy: \pm (3% of reading + 3 m Ω)
Dwell Timer	Range: 0.5 – 999.9 sec (0 = Continuous) Resolution: 0.1 sec Accuracy: \pm (0.1% + 0.05 sec)
Milliohm Offset	Range: 0 – 200m Ω Resolution: 1 m Ω Accuracy: \pm (2 % of setting + 2 m Ω)

CONTINUITY TEST MODE	
Output Current	DC 0.1A ± 0.01A Total Resistance*:0.00 – 12.0Ω DC 0.01A ± 0.001A Total Resistance*:12.1 – 120Ω DC 0.001A ± 0.0001A Total Resistance*:121 – 1200Ω DC 0.0001A ± 0.00001A Total Resistance*:1201 – 10000Ω
Resistance Display	Range 1: 0.00 – 10.00 Ω Resolution: 0.01 Ω Accuracy: ± (1 % of reading + 3 counts) Range 2: 10.1 – 100.0 Ω Resolution: 0.1 Ω Accuracy: ± (1 % of reading + 3 counts) Range 3: 101 – 1000 Ω Resolution: 1 Ω Accuracy: ± (1 % of reading + 3 counts) Range 4: 1001 – 10000 Ω Resolution: 1 Ω Accuracy: ± (1 % of reading + 10 counts)
HI and LO-Limits	Range 1: 0.00 – 10.00 Ω Resolution: 0.01 Ω Accuracy: ± (1 % of reading + 3 counts) Range 2: 10.1 – 100.0 Ω Resolution: 0.1 Ω Accuracy: ± (1 % of reading + 3 counts) Range 3: 101 – 1000 Ω Resolution: 1 Ω Accuracy: ± (1 % of reading + 3 counts) Range 4: 1001 – 10000 Ω Resolution: 1 Ω Accuracy: ± (1 % of reading + 10 counts) (Max Limit: 0 = OFF)
Dwell Timer	Range: 0.0, 0.3 – 999.9 sec (0 = Continuous) Resolution: 0.1 sec Accuracy: ± (0.1% + 0.05 sec)
Milliohm Offset	Range: 0.00 – 10.00Ω Resolution: 0.01 Ω Accuracy: ± (1 % of reading + 0.03 Ω)

GENERAL SPECIFICATIONS	
Safety Agency Listing	CE, cTUVus, EN50191(Models 8204, 8206, 8207), RoHS2
PLC Remote Control	Input: Test, Reset, Interlock, Recall File 1 through 3
	Output: Pass, Fail, Test-in-Process
Safety	Built-in Smart GFI circuit
Memory	10000 steps
Interface	Standard USB/RS-232, Ethernet, or GPIB.
Security	Advanced security system with access levels and username/password requirements
Graphic Display	800 x 480 digital TFT LCD display
Alarm Volume Setting	Range: 0 – 9; 0 = OFF, 1 is softest volume, 9 is loudest volume.
Calibration	Adjustments are made through the front panel. Automatic Calibration alert function to signal operator when calibration is due.
Mechanical	Bench or rack mount with tilt up front feet.
Dimensions	3U (W x H x D) (430 X 133 X 500 mm) (16.93" x 5.24" x 19.69")
Weight	31.16kgs (68.70lbs)
OPTIONS	
Scanning Matrix	8 channel high voltage and high current switching matrix.

Why use the term “Counts”?

Associated Research publishes some specifications using COUNTS which allows us to provide a better indication of the tester’s capabilities across measurement ranges. A COUNT refers to the lowest resolution of the display for a given measurement range. For example, if the resolution for voltage is 1V then 2 counts = 2V.

RUN TEST MODE (MODELS 82X6 AND 82X7)
DUT POWER

Voltage	0 – 277 VAC Single Phase Unbalanced (One Hot or Line conductor and One Neutral)	
Current	16AAC max continuous	
Voltage Display	Range:	0.0 – 277.0 VAC Full Scale
	Resolution:	0.1 V
	Accuracy:	$\pm (1.5\% \text{ of reading} + 0.2V)$, 30.0 – 277.0VAC
Short Circuit Protection	23 AAC, Response Time < 3s	

DELAY AND DWELL TIMER SETTINGS

Delay time setting	Range:	0.2 – 999.9 seconds
	Resolution:	0.1 second
	Accuracy:	$\pm (0.1\% + 0.05 \text{ sec})$
Dwell time setting	Range:	0.1 – 999.9 seconds (0 = Continuous)
	Resolution:	0.1 second
	Accuracy:	$\pm (0.1\% + 0.05 \text{ sec})$

TRIP POINT SETTINGS

Voltage: Volt-Hi Volt-LO	Range:	30.0 – 277.0 VAC
	Resolution:	0.1 V
	Accuracy:	$\pm (1.5\% \text{ of setting} + 0.2 \text{ V})$, 30.0 – 277VAC
Current: Amp-HI Amp-LO	Range:	0.0 – 16.00 AAC
	Resolution:	0.01 A
	Accuracy:	$\pm (2.0\% \text{ of setting} + 2 \text{ Counts})$
Watts: Power-HI Power-LO	Range:	0 – 4500 W
	Resolution:	1 W
	Accuracy:	$\pm (5.0\% \text{ of setting} + 3 \text{ Counts})$
Power Factor: PF-HI PF-LO	Range:	0.000 – 1.000
	Resolution:	0.001
	Accuracy:	$\pm (8\% \text{ of setting} + 2 \text{ Counts})$
Leakage Current: Leak-HI Leak-LO	Range:	0.00 – 10.00 mA (0 = OFF)
	Resolution:	0.01 mA
	Accuracy:	$\pm (2\% \text{ of setting} + 2 \text{ Counts})$
	Leakage current measuring resistor MD=2K Ω \pm 1%	

METERING

Voltmeter	Range:	0.0 – 277.0 VAC
	Resolution:	0.1 V
	Accuracy:	$\pm (1.5\% \text{ of reading} + 2 \text{ Counts})$, 30.0 – 277VAC
Ammeter	Range:	0.0 – 16.00 AAC
	Resolution:	0.01 A
	Accuracy:	$\pm (2.0\% \text{ of reading} + 2 \text{ Counts})$
Wattmeter	Range:	0 – 4500 W
	Resolution:	1 W
	Accuracy:	$\pm (5\% \text{ of reading} + 3 \text{ Counts})$

METERING

RUN TEST MODE (MODELS 82X6 AND 82X7)

Power Factor	Range: 0.000 – 1.000 Resolution: 0.001 Accuracy: \pm (8% of reading + 2 Counts)
Leakage Current	Range: 0.00 – 10.00 mA Resolution: 0.01 mA Accuracy: \pm (2% of reading + 2 Counts) Leakage current measuring resistor MD = 2K Ω \pm 1%
Timer display	Range: 0.0 – 999.9 seconds Resolution: 0.1 second Accuracy: \pm (0.1% of reading + 0.05 seconds)

LEAKAGE CURRENT TEST MODE (82X6 AND 82X7 ONLY)

DUT POWER

Voltage	0 – 277 VAC	
Current	16AAC max continuous	
Voltage Display	Range:	0.0 – 277.0 VAC Full Scale
	Resolution:	0.1 V
	Accuracy:	\pm (1.5% of reading +0.2V), 30.0 – 277.0VAC
Short Circuit Protection	23 AAC, Response Time < 3s	

DELAY AND DWELL TIMER SETTINGS

Delay time setting	Range: 0.5 – 999.9 seconds (AC+DC) 1.8-999.9 seconds (AC/DC Only and Auto Range) 1.3-999.9 seconds (AC/DC Only and Fixed Range) Resolution: 0.1 second Accuracy: \pm (0.1% + 0.05 sec)
Dwell time setting	Range: 0.0,0.5 – 999.9 seconds (AC+DC) 0.1-999.9 seconds (AC Only and DC Only) (0 = Continuous) Resolution: 0.1 second Accuracy: \pm (0.1% + 0.05 sec)

LINE CONDITION

Reverse Power Switch	Reverse polarity switch setting select ON/OFF/AUTO ON: Reverse power OFF: Normal AUTO: Automatic Reverse Polarity. With AUTO mode, the polarity switches for normal conditions in one step setting menu but will run two steps for both conditions. In this mode, the unit only records and displays the maximum leakage current value.
Neutral Switch	ON/OFF selection for single fault condition
Ground Switch	ON/OFF selection for Class I single fault condition

PROBE SETTING

Surface to Surface (PH – PL)
Surface to Line (PH – L)
Ground to Line (G – L)

LEAKAGE LIMIT SETTING		
Touch Current High Limit (RMS)	Range:	0.0uA ~ 999.9uA 1000uA ~ 10.00mA
	Resolution:	0.1uA / 1uA / 0.01mA
Touch Current Low Limit (RMS)	Range:	0.0uA ~ 999.9uA 1000uA ~ 10.00mA
	Resolution:	0.1uA/1uA/0.01mA
Touch Current High Limit (Peak)	Range:	0.0uA - 999.9uA 1000uA - 10.00mA
	Resolution:	0.1uA/1uA/0.01mA
Touch Current Low Limit (Peak)	Range:	0.0uA - 999.9uA 1000uA - 10.00mA
	Resolution:	0.1uA/1uA/0.01mA
DISPLAY		
Touch Current Display (RMS)	Range 1	0.0uA ~ 32.0uA, frequency DC, 15Hz - 1MHz
	Resolution	0.1uA
	Accuracy	DC , 15Hz ≤ f <100KHz: ±(2% of reading + 3counts) 100KHz ≤ f ≤ 1MHZ : ±5% of reading (10.0uA - 999.9uA)
	Range 2	28.0uA ~ 130.0uA, frequency DC, 15Hz - 1MHz
	Resolution	0.1uA
	Accuracy	DC , 15Hz ≤ f <100KHz: ±(2% of reading + 3counts) 100KHz ≤ f ≤ 1MHZ : ±5% of reading (10.0uA - 999.9uA)
	Range 3	120.0uA ~ 550.0uA, frequency DC, 15Hz - 1MHz
	Resolution	0.1uA
	Accuracy	DC , 15Hz ≤ f <100KHz: ±(2% of reading + 3counts) 100KHz ≤ f ≤ 1MHZ : ±5% of reading (10.0uA - 999.9uA)

DISPLAY (CONT.)		
	Range 4	400uA ~ 2100uA, frequency DC, 15Hz - 1MHz
	Resolution	1uA
	Accuracy	DC , 15Hz ≤ f < 100KHz: ±(2% of reading + 3counts) 100KHz ≤ f ≤ 1MHz : ±5% of reading (10uA - 8500uA)
	Range 5	1800uA ~ 8500uA, frequency DC, 15Hz - 1MHz
	Resolution	1uA
	Accuracy	DC , 15Hz ≤ f < 100KHz: ±(2% of reading + 3counts) 100KHz ≤ f ≤ 1MHz : ±5% of reading (10uA - 8500uA)
	Range 6	8.00mA ~ 10.00mA, frequency DC, 15Hz – 100kHz
	Resolution	0.01mA
	Accuracy	DC, 15Hz ≤ f ≤ 100KHz : ±5% of reading (0.01mA -10.00mA)
Touch Current Display (Peak)	Range 1	0.0uA ~ 32.0uA, frequency DC - 1MHz
	Resolution	0.1uA
	Accuracy	DC : ±(2% of reading + 2uA) 15Hz ≤ f ≤ 1MHz : ±10% of reading + 2uA
	Range 2	28.0uA ~ 130.0uA, frequency DC - 1MHz
	Resolution	0.1uA
	Accuracy	DC : ±(2% of reading + 2uA) 15Hz ≤ f ≤ 1MHz : ±10% of reading + 2uA
	Range 3	120.0uA ~ 550.0uA, frequency DC - 1MHz
	Resolution	0.1uA
	Accuracy	DC : ±(2% of reading + 2uA) 15Hz ≤ f ≤ 1MHz : ±10% of reading + 2uA

DISPLAY (CONT.)																			
	<table border="1"> <tr> <td>Range 4</td> <td>400uA ~ 2100uA, frequency DC - 1MHz</td> </tr> <tr> <td>Resolution</td> <td>1uA</td> </tr> <tr> <td>Accuracy</td> <td>DC : $\pm(2\%$ of reading + 2uA) 15Hz $\leq f \leq$ 1MHZ : $\pm 10\%$ of reading + 2uA</td> </tr> <tr> <td>Range 5</td> <td>1800A ~ 8500uA, frequency DC - 1MHz</td> </tr> <tr> <td>Resolution</td> <td>1uA</td> </tr> <tr> <td>Accuracy</td> <td>DC : $\pm(2\%$ of reading + 2uA) 15Hz $\leq f \leq$ 1MHZ : $\pm 10\%$ of reading + 2uA</td> </tr> <tr> <td>Range 6</td> <td>8.0mA ~10.00mA, frequency DC – 100KHz</td> </tr> <tr> <td>Resolution</td> <td>0.01mA</td> </tr> <tr> <td>Accuracy</td> <td>DC : $\pm(2\%$ of reading + 3counts) 15Hz $\leq f \leq$ 100KHz : $\pm 10\%$ of reading + 2counts</td> </tr> </table>	Range 4	400uA ~ 2100uA, frequency DC - 1MHz	Resolution	1uA	Accuracy	DC : $\pm(2\%$ of reading + 2uA) 15Hz $\leq f \leq$ 1MHZ : $\pm 10\%$ of reading + 2uA	Range 5	1800A ~ 8500uA, frequency DC - 1MHz	Resolution	1uA	Accuracy	DC : $\pm(2\%$ of reading + 2uA) 15Hz $\leq f \leq$ 1MHZ : $\pm 10\%$ of reading + 2uA	Range 6	8.0mA ~10.00mA, frequency DC – 100KHz	Resolution	0.01mA	Accuracy	DC : $\pm(2\%$ of reading + 3counts) 15Hz $\leq f \leq$ 100KHz : $\pm 10\%$ of reading + 2counts
Range 4	400uA ~ 2100uA, frequency DC - 1MHz																		
Resolution	1uA																		
Accuracy	DC : $\pm(2\%$ of reading + 2uA) 15Hz $\leq f \leq$ 1MHZ : $\pm 10\%$ of reading + 2uA																		
Range 5	1800A ~ 8500uA, frequency DC - 1MHz																		
Resolution	1uA																		
Accuracy	DC : $\pm(2\%$ of reading + 2uA) 15Hz $\leq f \leq$ 1MHZ : $\pm 10\%$ of reading + 2uA																		
Range 6	8.0mA ~10.00mA, frequency DC – 100KHz																		
Resolution	0.01mA																		
Accuracy	DC : $\pm(2\%$ of reading + 3counts) 15Hz $\leq f \leq$ 100KHz : $\pm 10\%$ of reading + 2counts																		
MD CIRCUIT MODULE																			
MD1	UL544NP, UL484 , UL923, UL471, UL867, UL697																		
MD2	UL544P																		
MD3	IEC 60601-1																		
MD4	UL1563																		
MD5	IEC60990 Fig4-U1, IEC60950																		
MD6	IEC60990 Fig4 U2, IEC 60950-1, IEC60335-1, IEC60598-1, IEC60065, IEC61010																		
MD7	IEC60990 Fig5 U3, IEC60598-1																		
External MD	Basic measuring element 1k ohm																		
Scope Output Interface	BNC type connector on rear panel for Oscilloscope connection																		
MD voltage limit	Maximum 70VDC																		
MD Component Accuracy	Capacitors = 5% Resistors = 1%																		

AC SOURCE 500VA				
OUTPUT				
Power	630VA and 500W Maximum			
Voltage	0 - 150.0V / 0 - 277.0V			
Current	4.20A maximum for 0-150V range / 2.10A maximum 0-277V range			
Distortion	≤ 1% at 45-500Hz and output voltage within the 80~140Vac at Low Range or the 160~277Vac at High Range. (Resistive Load)			
Regulation	≤ 0.5% + 5V (Resistive Load), From no load to full load and Low Line to High Line (combined regulation)			
Crest Factor	> 3			
Test timing limit	< 350mS at start and between steps when internal AC source is ON			
SETTINGS				
Voltage	Low range	0.0 - 150.0V	0.1	± (1.5% of setting + 2 counts)
	High range	0.0 - 277.0V		
Frequency	45.0Hz - 99.9Hz		0.1	±0.1% of setting
	100Hz - 500Hz		1	
A-Hi-limit	Range		4.20A/2.10A	
	Resolution		0.01	
	Accuracy		± (2 % of reading +2 counts)	
OC Fold Current	Range		4.20A/2.10A	
	Resolution		0.01	
	Accuracy		± (2 % of reading +2 counts)	
	Response time		< 1500ms	
MEASUREMENT				
Voltage	0.0-277.0		0.1	± (1.5 % of reading +2 counts)
Current	0.00-16.00		0.01	± (2 % of reading +2 counts)
Power	0-4500		1	± (5% of reading +3 counts) for PF>0.100
Power Factor	0.000-1.000		0.001	± (8 % of reading +5 counts)
Frequency	45-500Hz		0.1	±0.1Hz
GENERAL				
Over Current Fold back	On/Off, When the output current exceeds the A-Hi value it will fold back output voltage to keep constant output current at A-Hi value.			
Protection	OCP, OTP, OVP, OPP and Alarm			

3.2. Instrument Controls

3.2.1. Front Panel Controls

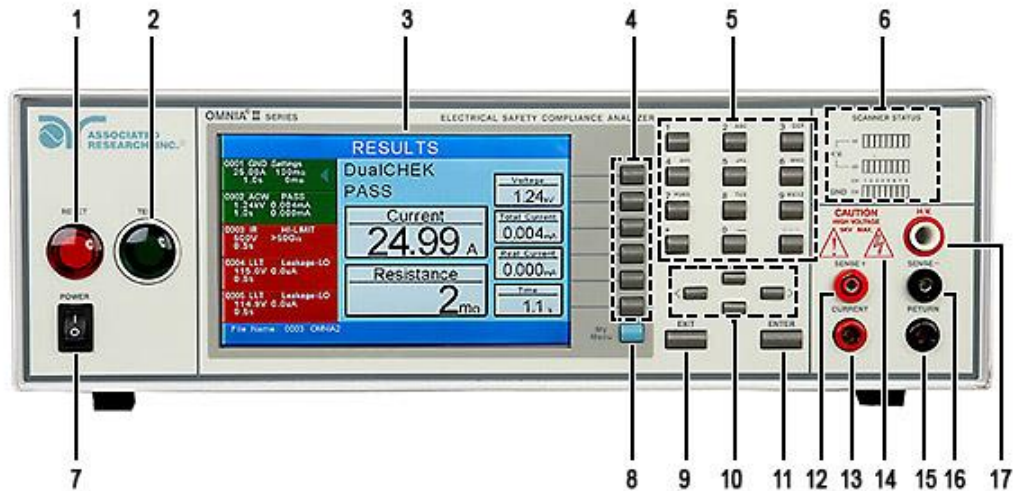

1. **RESET BUTTON:** Resets the instrument. If a failure condition occurs during a test, pressing this button will reset the system, shut off the alarm and clear the failure condition. The Reset button must be pressed before performing another test or changing any of the setup parameters. This button also serves as an abort signal to stop any test in progress.
2. **TEST BUTTON:** Starts a test.
3. **GRAPHIC TFT:** 800 X 480 Color TFT display.
4. **SOFT KEYS:** Multifunction keys used to select screens and change parameters.
5. **NUMERIC DATA ENTRY:** Keys used to enter numeric data.
6. **SCANNER STATUS LED's:** LED's that indicate the status of the 8 H.V. and 8 G-Bond channels on the internal scanner.
7. **POWER SWITCH:** Turns the Hipot tester ON or OFF.
8. **MY MENU KEY:** Selects the My Menu screen with user-customizable soft keys.
9. **EXIT KEY:** Key used to escape from parameter editing and return to prior screens.
10. **UP, DOWN, LEFT, AND RIGHT, ARROW KEYS:** Keys used to scroll the highlighted area or cursor, up and down, left and right. When more than 5 steps are programmed in a test file, the left and right arrow keys will page through the screens of steps. The screens where the paging function is available are as

follows: Setup Tests, Perform Tests, Results Summary, and Results.

- 11. ENTER KEY:** Key used to finalize parameter entries. The ENTER key may also be used to scroll the highlighted area to different parameters in the parameter setting screens.
- 12. SENSE + TERMINAL:** Connector used to attach the + sense lead for 4-wire Kelvin current measurement. This connection provides for accurate current measurement during the Ground Bond test.
- 13. CURRENT OUTPUT TERMINAL:** Connector used to attach the high current output lead, adapter box high current lead or test fixture high current lead to the instrument. This connection provides the output current for the ground bond and continuity.
- 14. HIGH VOLTAGE INDICATOR:** This indicator flashes to warn the operator that high voltage is present at the high voltage output terminal.
- 15. RETURN OUTPUT TERMINAL:** Connector used to attach the return test lead, adapter box return lead or test fixture return lead to the instrument. This connection provides the return current path.
- 16. SENSE - TERMINAL:** Connector used to attach the - sense lead for 4-wire Kelvin current measurement. This connection provides for accurate current measurement during the Ground Bond test.
- 17. HIGH VOLTAGE OUTPUT TERMINAL:** Connector used to attach the high voltage test lead, adapter box high voltage lead or test fixture high voltage lead to the instrument. This connection provides the high voltage used during a Hipot test.

3.2.2. Rear Panel Controls

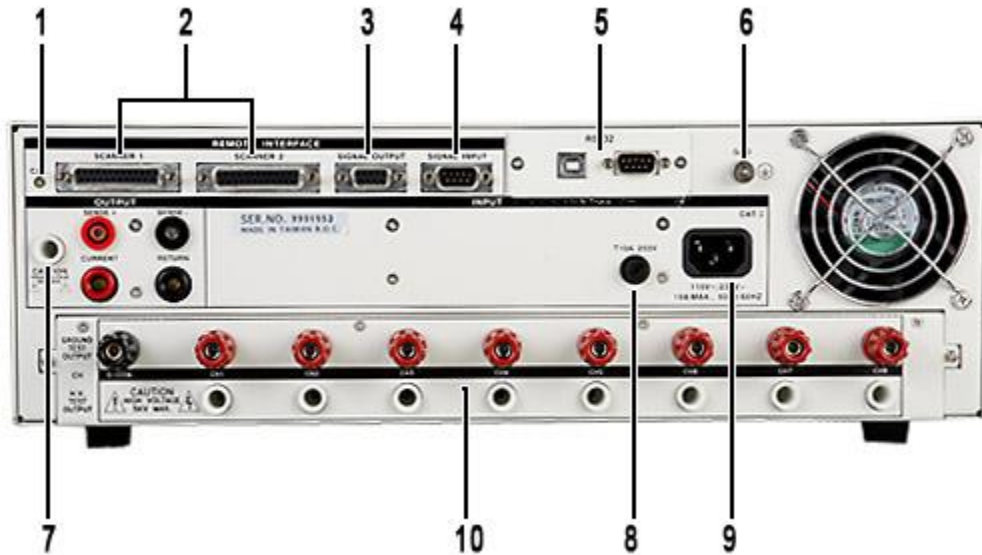

1. **CALIBRATION BUTTON:** To put the instrument into the calibration mode push this button and turn on the power switch simultaneously.
2. **SCANNER CONNECTOR:** For connection of optional external Scanner.
3. **REMOTE SIGNAL OUTPUT:** 9-Pin D sub-miniature female connector for monitoring PASS, FAIL, and PROCESSING output relay signals (See section **6.0. Connection of Remote I/O** for more detailed information).
4. **REMOTE SIGNAL INPUT:** 9-Pin D subminiature male connector for remote control of TEST, RESET, and REMOTE INTERLOCK DISABLE functions, as well as MEMORY SELECTION (See section **6.0. Connection of Remote I/O** for more detailed information).
5. **BUS INTERFACE:** Standard connector for interconnection to the USB/RS-232 Bus interface. Optional IEEE 488 or Ethernet may be substituted for USB/RS-232.
6. **CHASSIS GROUND (EARTH) CONNECTION:** This terminal should be connected to a good earth ground before operation.
7. **REAR PANEL OUTPUT TERMINALS:** 2nd set of output connectors in parallel with the front panel connectors.
8. **FUSE RECEPTACLE:** To change the fuse, unplug the power (mains) cord and turn the fuse receptacle counter-clockwise. The fuse compartment will be exposed. Please replace the fuse with one of the proper rating.
9. **INPUT POWER RECEPTACLE:** Standard IEC 320 connector for connection to a standard NEMA style line power (mains) cord.

10. SCANNER OUTPUTS : Optional scanner matrix that provides 8 HV/Return connections and 8 Ground Bond connections. Please refer to the Options section of this manual for additional connection information

3.2.3. Additional Rear Panel Controls Models 82x6 and 82x7

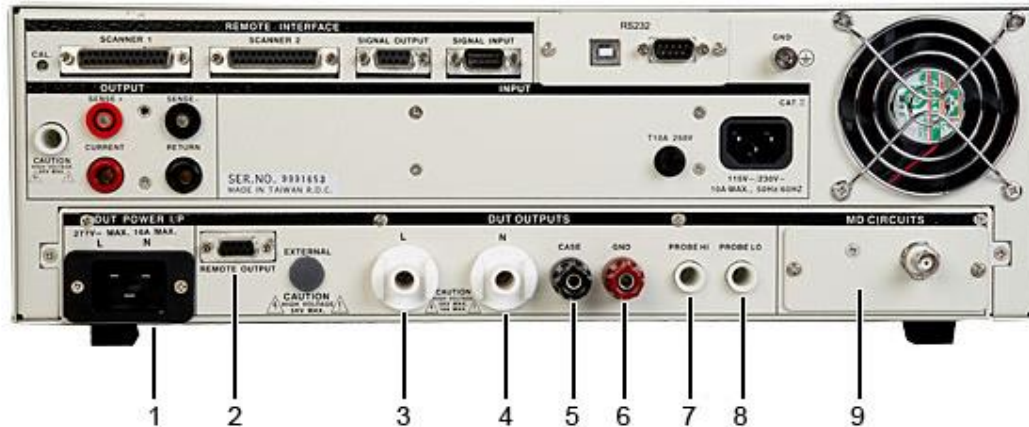

1. **DUT POWER INPUT CONNECTOR:** This connector provides the Line and Neutral input power connections on pin 1 and 2 respectively. An external single phase unbalanced AC power supply with a single Hot or Line conductor should be connected here to supply power to the DUT while performing the leakage test. This input is rated for 0-277 volts 50/60 Hz.
2. **REMOTE OUTPUT:** Optional connector used to interface the OMNIA with an APT AC power source for remote memory selection (Option 05).
3. **L OUTPUT TERMINAL:** Connector used to attach the adapter box high voltage test lead to the instrument. Line power is supplied to the DUT during the run test or Leakage Current test through this connector and High Voltage is supplied to the DUT through this connector during the Dielectric Withstand or Insulation Resistance tests. This terminal and the “N” terminal are shorted together when the Dielectric Withstand or Insulation Resistance tests are being performed.
4. **N OUTPUT TERMINAL:** Connector used to attach the adapter box return test lead to the instrument. Line power is supplied to the DUT during the run test or Leakage Current test through this terminal and High Voltage is supplied to the DUT through this terminal during the Dielectric Withstand or Insulation Resistance tests. This terminal and the “L” terminal are shorted together when the Dielectric Withstand or Insulation Resistance tests are being performed.
5. **CASE:** Connector used to attach the return lead to the DUT case or dead metal. Provides the return for the Ground Bond, Dielectric Withstand, and Insulation

Resistance tests. During a Run test or Leakage Current test, this terminal is isolated from the test circuits.

6. **GND:** Connector used to attach the adapter box Ground or Earth lead to the instrument.
7. **PROBE HI:** Connector used to attach the Probe-HI test lead to the DUT. When used with an appropriate test lead, this terminal connects one side of the MD (measuring device) to the DUT during Enclosure or Applied Part Leakage Current tests. This terminal will be enabled during a Leakage Current test whenever Probe-HI has been selected. When a Functional Run test or Leakage Current test is not being performed, this terminal is isolated from the Functional Run test and Leakage Current test circuits.
8. **PROBE LO:** Connector used to attach the Probe-LO test lead to the DUT. When used with an appropriate test lead, this terminal connects one side of the MD (measuring device) to the DUT during Applied Part Leakage Current tests. The terminal is always used in conjunction with the Probe-HI terminal. When a Functional Run test or Leakage Current test is not being performed, this terminal is isolated from the Run test and Leakage Current test circuits.
9. **MD CIRCUITS:** Contains an external Measuring Device PCB that will enable during a Leakage Current test when “External” is selected using the “Meas. Device” soft key. The external MD allows the operator to configure a custom measuring device using either a simple resistive component or a complex two pole network.

4. PROGRAMMING INSTRUCTIONS

4.1. Power Up

The OMNIA automatically defaults to the Main Menu screen upon power up. The Main Menu screen will appear as follows:

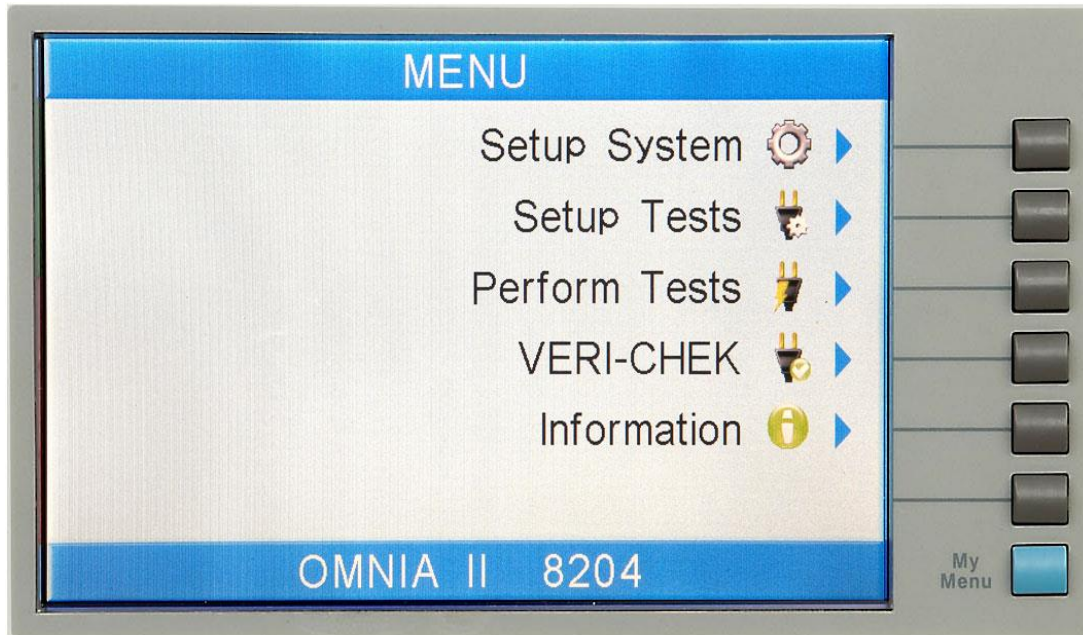

From the Main Menu screen five menu screens may be accessed: Setup System, Setup Tests, Perform Tests, FailCHEK and Information

4.2. Setup System

From the Main Menu screen, press the "Setup System" soft key. The Setup System screen will now be displayed. From the Setup System screen, five different hardware and software controls may be accessed: Time and Date, Calibration Alert, Hardware, Security and User Interface. Pressing the EXIT key at any time will return you to the Main Menu screen.

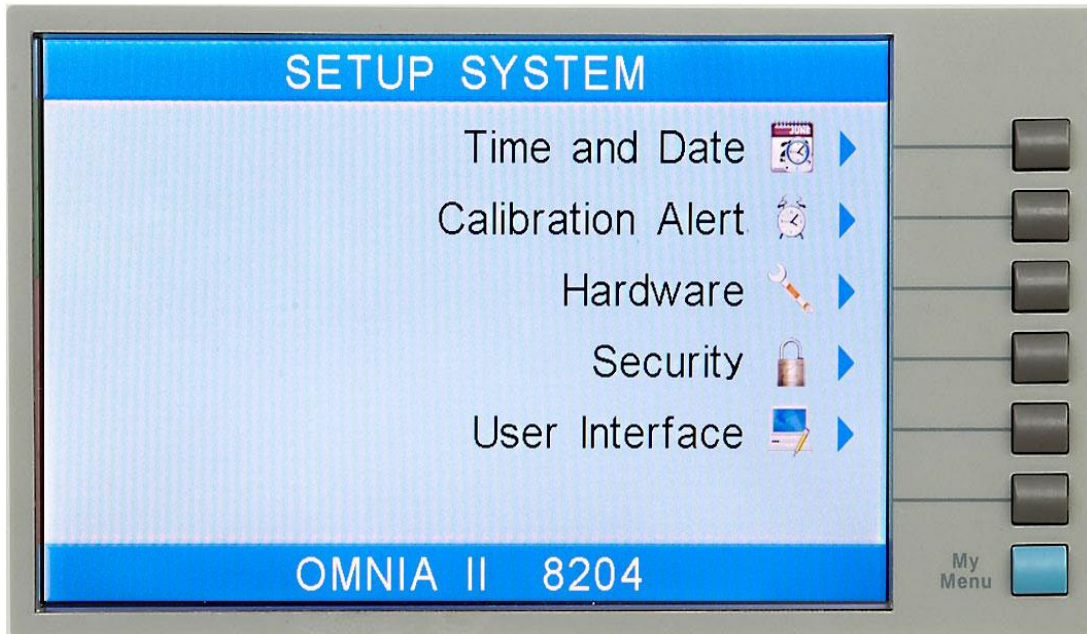

4.2.1. Setup System Keys

Soft Keys

In the Setup System screen, the soft keys correspond to several setup screens. Use the soft keys to enter the corresponding system screen. Once a system screen has been entered, the soft keys can be used to edit parameters. Press the soft key to edit the corresponding parameter. ENTER does not need to be pressed to confirm the values that pertain to the soft keys.

Directional soft keys < , > , ^, v

The “< , > , ^, v” soft keys are used to scroll the cursor to the different system parameters.

ENTER

The ENTER key is used to confirm a value for a particular parameter.

EXIT

The EXIT key is used to return to the Perform Tests screen from the Setup System screen or will bring you back to the Setup System screen from the editing menu screens.

4.2.2. Time and Date

From the Setup System screen press the “Time and Date” soft key. The Time and Date Setting screen will now be displayed. From this screen, five different parameters may be accessed: Set Date, Set Time, Set Day, Date Format and Time Format. The Time and Date Setting screen will appear as follows:

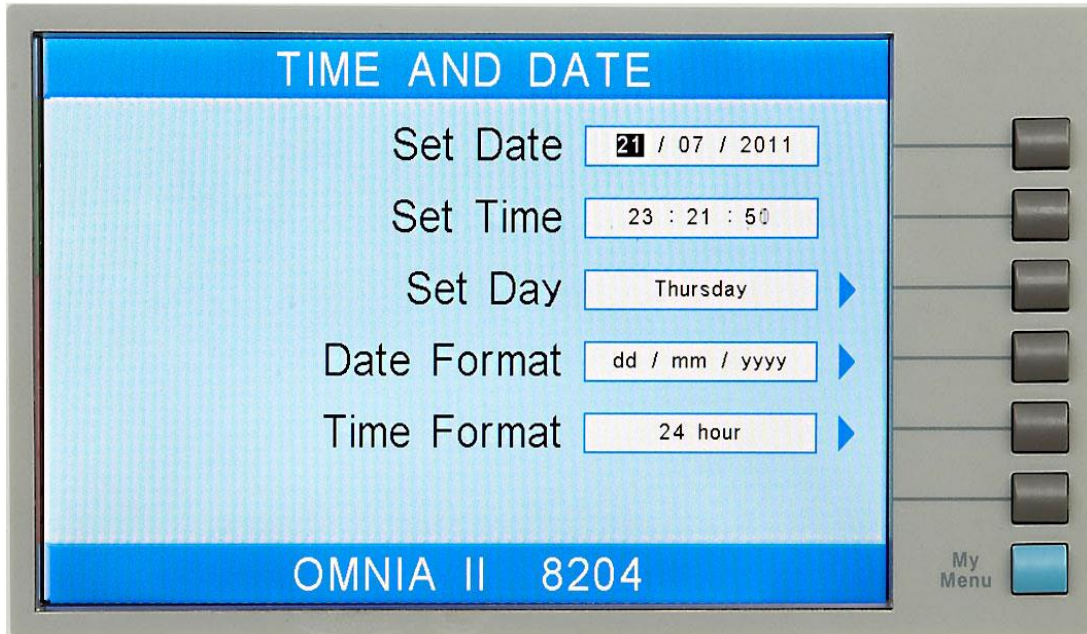

Set Date

From the Time and Date Setting screen, highlight the Set Date parameter by using the left and right arrow keys.

Within the Set Date parameter are three separate fields: month, day, and year. Using the left and right arrow keys select the field within the date that you want to edit. Using the numeric keypad enter the new number. Once you begin typing a new number the parameter will blank and the cursor will begin blinking. This indicates that the parameter is being edited.

Once a parameter is edited, it is necessary to complete the edit either by pressing the ENTER key to accept the new number or the EXIT key to escape from the edit and return to the original number.

Set Time

From the Time and Date Setting screen highlight the Set Time parameter by using the left or right arrow keys.

Within the Set Time parameter are three separate fields, hours, minutes, and seconds. Using the left and right arrow keys to select the field within the time parameter you want to edit. Using the numeric keypad enter the new number. Once you begin typing a new number, the parameter will blank and the cursor will begin blinking. This indicates that the parameter is being edited.

Once a parameter is edited, it is necessary to complete the edit either by pressing the ENTER key to accept the new number or the EXIT key to escape from the edit and return to the original number.

Set Day

From the Time and Date Setting screen, press the “Set Day” soft key. As the soft key is pressed, the “Set Day” pop up screen will appear as follows:



Use the up or down arrow keys to select the day of the week.

Once a parameter is edited, it is necessary to complete the edit either by pressing the ENTER key to accept the new value or the EXIT key to escape from the edit and return to the original value.

Date Format

From the Time and Date Setting screen, press the “Date Format” soft key. As the soft key is pressed, the “Date Format” pop up screen will appear as follows:

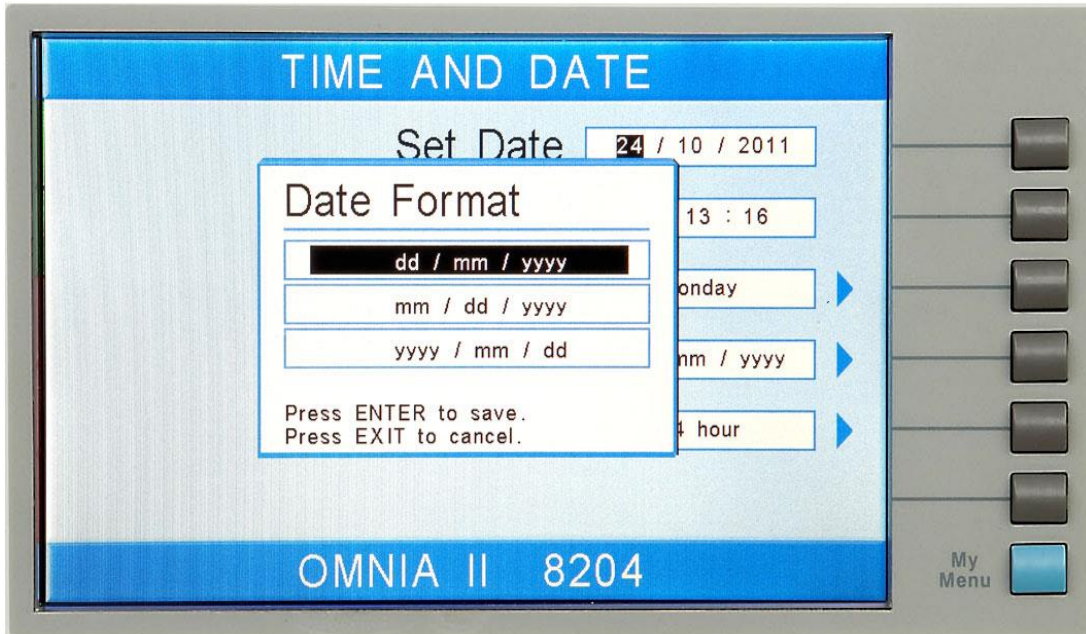

Use the up or down arrow keys to select the date format.

Once a parameter is edited, it is necessary to complete the edit either by pressing the ENTER key to accept the new value or the EXIT key to escape from the edit and return to the original value.

Time Format

From the Time and Date Setting screen, press the “Time Format” soft key. As the soft key is pressed, the time format will toggle between 12 hour and 24 hour modes.

4.2.3. Calibration Alert

Calibration Alert is a feature that will allow the instrument to give an advanced alert that the calibration for the instrument is coming due. From the System Setup screen, press the “Calibration Alert” soft key. The Calibration Alert Setting screen will now be displayed. From the Calibration Alert Setting screen, three different parameters may be accessed: Calibration Due, Alert Date, Calibration Alert. The Calibration Alert Setting screen also displays the date of the last performed calibration. The Calibration Alert Setting screen will appear as follows:

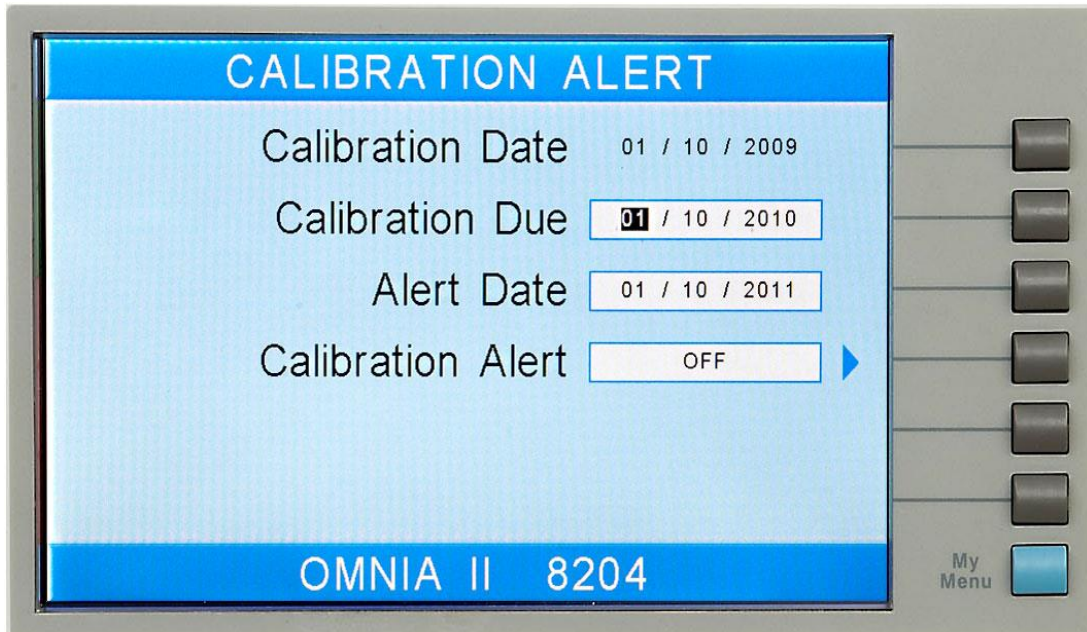

Calibration Due Date

It is recommended that calibration should be performed at least once a year. It is recommended that the Calibration Due Date not be set greater than one year from the Calibration Date displayed.

From the Calibration Alert Setting screen, highlight the Calibration Due parameter by using the left or right arrow keys. The left and right arrow keys will toggle the highlighted area of the screen between the Calibration Due and Alert Date.

Using the left and right arrow keys and the numeric keypad enter the Calibration Due Date. Press the ENTER key to finish.

Alert Date

The Alert Date is like an alarm clock that will warn you in advance of the actual calibration due date. After a calibration is performed the Alert Date is automatically set 11 months after the calibration date. For example, if the calibration is performed on 12/15/2012 the Alert Date will automatically be set to 11/15/2013. Although this date is automatically written into the Alert Date location, it may be manually overwritten to any advanced date desired.

At the Calibration Alert setting screen, highlight the Alert Date parameter by using the left or right arrow keys. The left and right arrow keys will toggle the highlighted area of the screen between the Calibration Due and Alert Date.

Within the Alert Date parameter are three separate fields: month, day, and year. Using the left and right arrow keys select the field you want to edit. Using the numeric keypad enter the new number. Once you begin typing a new number, the parameter will blank and the cursor will begin blinking. This indicates that the parameter is being edited. Once a parameter is edited, it is necessary to complete the edit either by

pressing the ENTER key to accept the new number or the EXIT key to escape from the edit and return to the original number.

The Calibration Alert Warning screen appears as follows:



At the Calibration Alert Warning screen there are three options: “Show this screen again?”, Password, and OK. “Show this screen again?” is asking if you would like to continue seeing the Calibration Alert Warning screen every time you power up the instrument. You may turn this screen OFF by toggling to the word “No” using the soft key next to this parameter. If the instrument is password-protected you will need to enter the password in order to turn off the “Show this screen again” parameter. Selecting the “Show this screen again” parameter OFF will disable the Calibration Alert function. Pressing the OK soft key will exit the Calibration Alert Warning screen and go to the standard introduction screen.

Calibration Alert On/Off

From the Cal. Alert Setting screen you may turn the Calibration Alert function ON and OFF by pressing the “Calibration Alert” soft key. If the “Show this screen again?” function has been turned OFF at the Calibration Alert Warning screen, this parameter will automatically be set to OFF. Turning this parameter ON will activate the Cal Alert function and when the date matches the Alert Date, the instrument will display the Calibration Alert Warning screen upon power up.

4.2.4. Hardware

From the System Setup screen, press the “Hardware” soft key. The Hardware Setting screen will now be displayed. From the Hardware Setting screen, six different parameters may be accessed: Smart GFI, Continuity Scanner, PLC Remote, DUT-HV Setup, AC Source, and Measurement. The Hardware Setting screen will appear as follows:

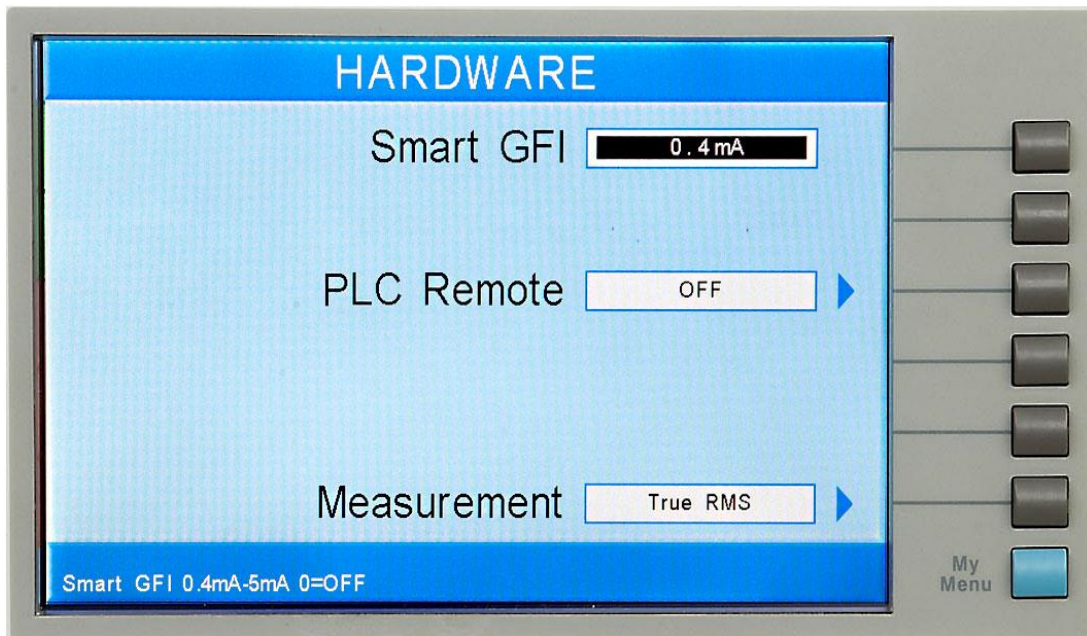

Smart GFI (Ground Fault Interrupt)

The high voltage power supply of the OMNIA is internally referenced to earth ground. Since the leakage current measuring circuit of the instrument monitors only current that flows through the return lead the possibility exists for current to flow directly from the high voltage output to earth ground without being measured. The SmartGFI (Ground Fault Interrupt) circuit monitors the current between the high voltage output and earth ground. Therefore, if the operator touches the high voltage lead and earth ground, the instrument will detect this hazardous condition and shut off immediately.

SmartGFI goes beyond a standard GFI circuit by automatically determining the return configuration of the DUT (grounded or floating) and enabling or disabling depending on the situation. When the OMNIA's Return lead is floating, the SmartGFI circuit enables, protecting the test operator from electric shock. When the OMNIA's Return lead is earth grounded, the SmartGFI circuit disables and the instrument operates in a grounded return mode of operation. If the GFI were to remain active in this state, the tester would continuously fail since all current is returning through earth ground. By disabling the SmartGFI circuit and operating in a grounded return mode, OMNIA allows the user to perform tests on devices that have their chassis's earth grounded by the test fixture or test environment.

In the Hardware Setting screen, highlight the SmartGFI parameter by using the up or down arrow keys.

Use the numeric keypad to set the mA value of the SmartGFI in the instrument. The SmartGFI can be set to 0 or adjusted from 0.4-5.0mA (where 0 = OFF).

Selecting the Smart GFI = 0, will only disable the ground current failure detectors. It does not disable the capability to externally earth ground the return lead.

Continuity Scanner (8204)

This selection will only be available if option 01: Internal Scanner is installed on the unit. For more information on this option, please refer to section **8. Options**.

You may toggle between the HV Channel (High Voltage) and GND Channel (Ground Bond) selection by pressing the “Continuity Scanner” soft key.

The Continuity Scanner setting allows the user to set the function of the scanner channels for a DC Continuity test. The High Voltage/Continuity channels can be set to a High or Low level, giving the capability to test from one channel to another channel or from any channel to a common Low or Return point. The channels can be connected in parallel if desired but there is only one leakage current measurement for all channels.

The Ground Bond/Continuity channels can only be used to test from one channel to the common Return. Only one channel may be used for each Ground Bond or Continuity test. The Ground Bond or Continuity test will be performed between the output channel selected and the Ground Bond/Continuity common terminal.

PLC Remote

From the Hardware Setting screen, you may turn the PLC remote ON and OFF by pressing the “PLC Remote” soft key. Refer to the section **6. Connection of Remote I/O** for details.

When the PLC remote is turned ON, the front panel TEST button is disabled and a test may only be started through the rear panel I/O. If you attempt to start a test from the front panel TEST button when the PLC Remote function is turned “ON”, a pop-up message will be displayed. The pop-up message will appear as follows:

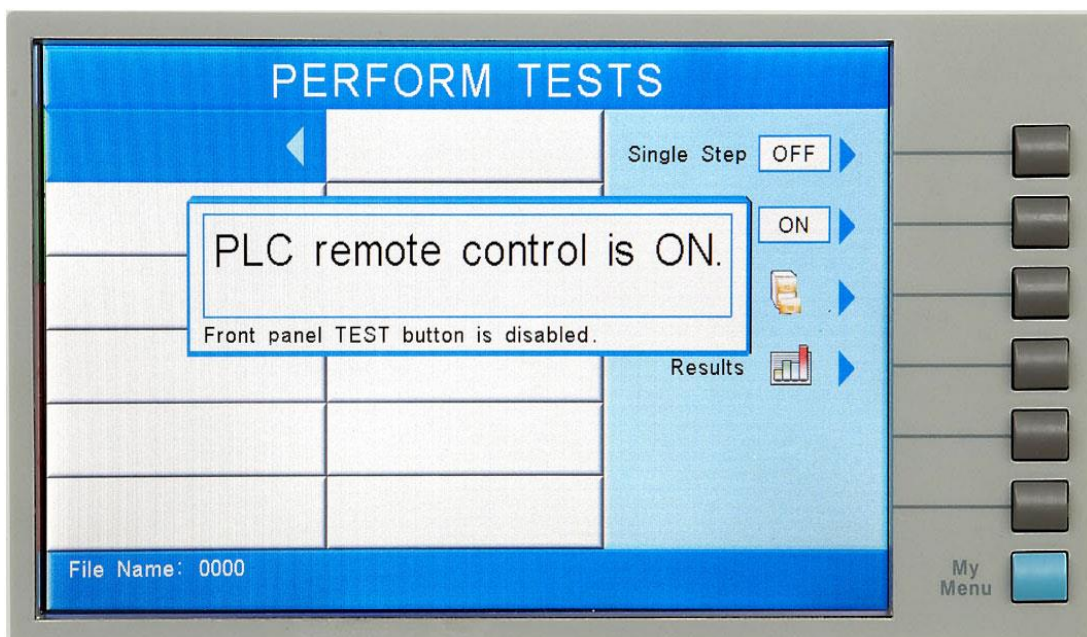

DUT-HV Setup (82x6 and 82x7)

The DUT-HV selection activates an additional parameter in the AC Withstand, DC Withstand and IR Tests parameter screens. The additional parameter is called “DUT Output” and its function is to control the high voltage relay at the DUT output.

When the DUT Output parameter is turned ON during an AC Withstand, DC Withstand, or IR test, high voltage will be present at the DUT outputs as well as the front and rear panel HV connectors. When the DUT Output parameter is turned OFF, no high voltage will be present at the DUT connectors, only the front and rear panel HV connectors will have high voltage.

From the Hardware Setting screen, you may turn the DUT-HV parameter selection ON and OFF by pressing the “DUT-HV Setup” soft key. Selecting the DUT-HV = “OFF”, will prevent the parameter from appearing on the AC Withstand, DC Withstand, and IR test parameter setting screens. With DUT-HV = OFF, high voltage will automatically be present on the DUT output.

Please refer to section **4.4. Test Parameters** for additional parameter information and screen appearance.

AC Source (82x7)

From the Hardware Setting screen, you may turn the AC Source parameter selection ON and OFF by press the “AC Source” soft key. When the AC Source is turned ON, the 500VA power source is available for use during RUN and LCT testing. An additional set of parameters will be available in the RUN Test Parameter Setting screen and the LCT Test Parameter Setting screen.

Please refer to section **4.4. Test Parameters** for additional parameter information and screen appearance.

Measurement

From the Hardware Setting screen, press the “Measurement” soft key. As the soft key is pressed, the measurement method will toggle between True RMS or Average.

4.2.5. Security

From the System Setup screen press the “Security” soft key. The Security screen appears as follows:

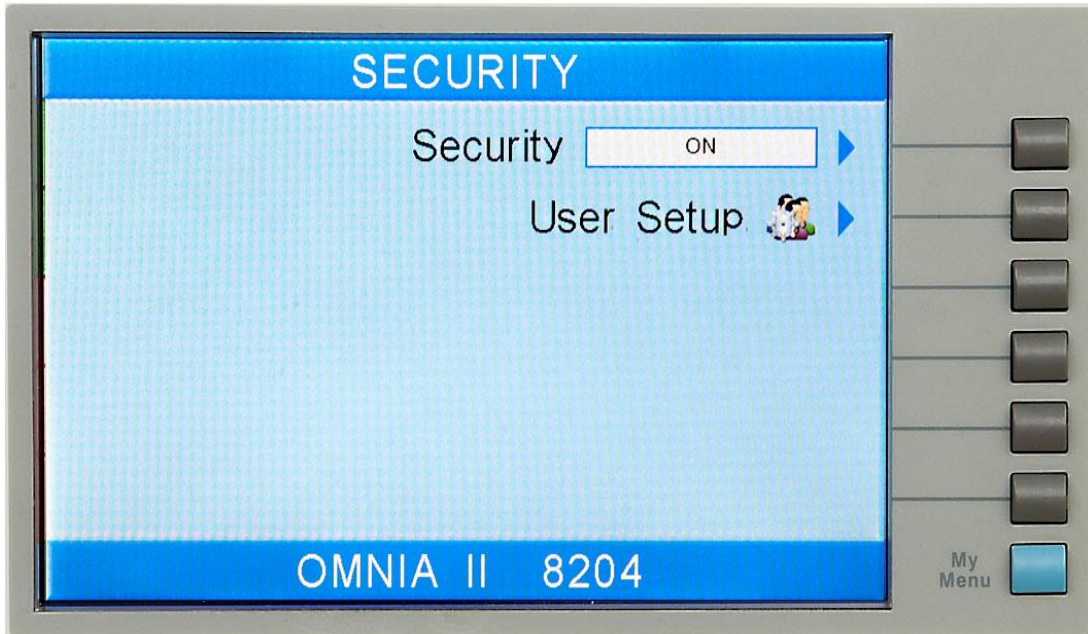

Security

From the Security screen you may turn the Security function ON and OFF by pressing the “Security” soft key. Selecting Security OFF disables all security features and User ID settings. Selecting security ON restricts access to parameter settings. The level of security is determined by the User Setup function.

User Setup

From the Security screen, press the User Setup soft key. As the soft key is pressed, you will be taken to the User Setup screen. There are three functions available in the User Setup screen: Add User, Edit User and Delete User. The User Setup screen will appear as follows:



From the User Setup screen, you can view the list of users currently setup and the associated security level. The OMNIA will have a default User ID named ADMIN with Full System Access security level. This User ID cannot be deleted.

Add User

From the User Setup screen, press the Add User soft key. As the soft key is pressed, you will be taken to the Add User screen.

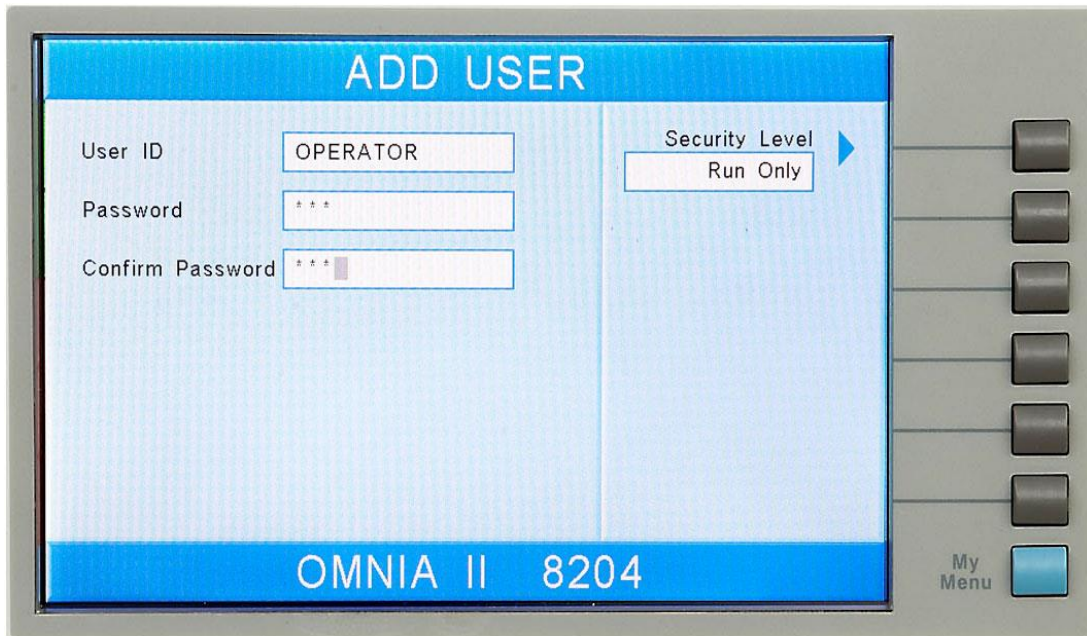

From this screen, a new user can be added by entering an alpha/numeric User ID, Password, Password Confirmation and desired security level.

User ID

To enter a User ID, use the up and down arrow keys to select the User ID parameter. Use the alpha/numeric keypad to add a User ID. The User ID is limited to 8 characters.

Once the User ID parameter is edited, it is necessary to complete the edit either by pressing the ENTER key to accept the new User ID or the EXIT key to escape from the edit and delete the User ID.

Password

Each User ID must have a password associated with it. To enter a Password, use the up and down arrow keys to select the Password parameter. Use the alpha/numeric keypad to enter a password. The password is limited to 8 characters.

Once the password is entered, it is necessary to complete the edit either by pressing the ENTER key to accept the new password or the EXIT key to escape from the edit and delete the password.

Confirm Password

In order to complete the password entry, the password must be confirmed by retyping the password into the Confirm Password parameter. To confirm the password, use the up and down arrow keys to select the Confirm Password parameter. Use the alpha/numeric keypad to retype the password.

Once the password is entered, it is necessary to complete the edit either by pressing the ENTER key to accept the new password or the EXIT key to escape from the edit and delete the password. NOTE: Once the ENTER key is pressed, the User ID will be set. Edit the Security Level parameter prior to confirming the password.

Security Level

From the Add User screen, press the “Security Level” soft key. As the soft key is pressed, the “Security Level” pop up screen will appear as follows:

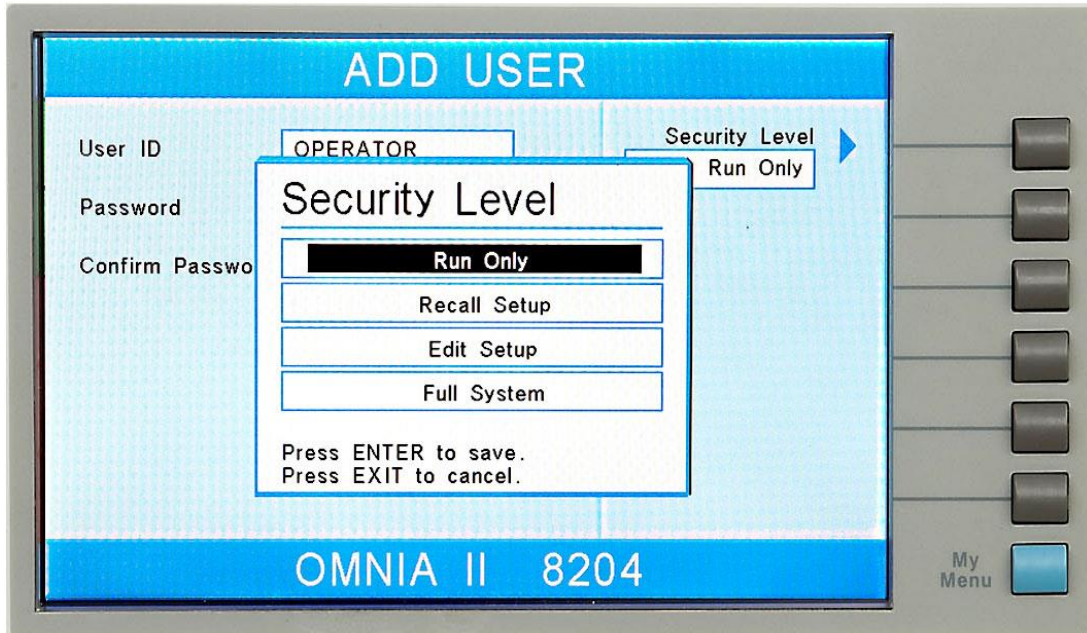

Use the up or down arrow keys to select the Security Level.

Once a parameter is edited, it is necessary to complete the edit either by pressing the ENTER key to accept the new value or the EXIT key to escape from the edit and return to the original value.

The security levels are as follows:

- Run Only: This is the most restricted mode of user access. The user can only initiate a test, reset a failure or abort a test from the Perform Tests screen.
- **NOTE:** whenever a user's security level is Run Only, “Single Step” and “Fail Stop” soft keys will be disabled at the Perform Test screen.

- **NOTE:** whenever a user's security level is Run Only, you may only start at test step 1.
- **Recall Setups:** This mode allows the user to load previously configured test files but it does not allow any editing of the parameters. In this mode the user is restricted from access to the "Setup Test Parameters" screen.
- **Edit Setups:** In this mode the user can load files and edit test parameters.
- **Full System Access:** In this mode the user has full access level to all instrument setup parameters as well as system configuration and security levels. Access at this level should be restricted to System Administrators.

Edit User

From the User Setup screen, use the up and down arrows to select the User ID you would like to edit. Press the Edit User soft key. As the soft key is pressed, the Edit User screen appear as follows:



From this screen, the User ID, Password and Security Level can be changed by entering an alpha/numeric User ID, Password, Password Confirmation and desired security level. Please refer to the "User ID", "Password", "Confirm Password" and "Security Level" sections above for more information.

Delete User

From the User Setup screen, use the up and down arrows to select the User ID you would like to delete. Press the Delete User soft key. As the soft key is pressed, the selected User ID will be deleted from the User ID list. NOTE: Once a User ID is

deleted, it cannot be recovered. The User ID must be recreated by adding a new user. Please refer to the “Add User” section above for more information.

Forgotten Password

If you have forgotten your password you may access a User ID by typing in the number “8000” into the password field. The old password cannot be recovered. A new password should be entered by editing the USER ID in the Edit User screen. Please refer to the “Edit User” section above for more information.

4.2.6. User Interface

From the System Setup screen press the “User Interface” soft key. From the User Interface screen, five different parameters may be accessed: Alarm Volume, Step Name, Language, Color Style and Power-On Screens. The User Interface screen will appear as follows:

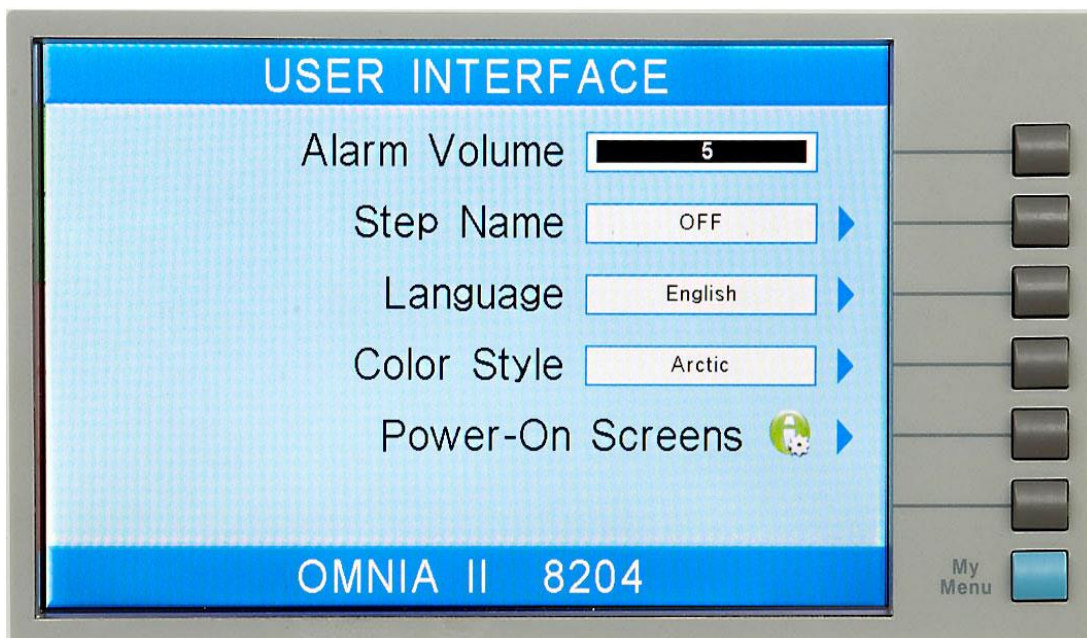

Alarm Volume

In the User Interface screen, the Alarm Volume parameter will automatically be highlighted. Use the alphanumeric keypad to set the volume of the alarm in the instrument, then press the ENTER key. The numbers corresponding to the different volume settings are 1 through 9, 1 meaning the volume is off, and 9 being the loudest setting. After the number is entered, a momentary alarm chirp will occur to indicate the volume of the new setting.

Step Name

From the User Interface screen, press the “Step Name” soft key. As the soft key is pressed, the step name parameter will toggle between ON and OFF. Setting the step name parameter to ON will allow the user to enter an alphanumeric name for each individual step in a test sequence. Please refer to section X.X.X for more information.

Language

From the User Interface screen, press the “Language” soft key. As the soft key is pressed, the “Language” pop up screen will appear as follows:

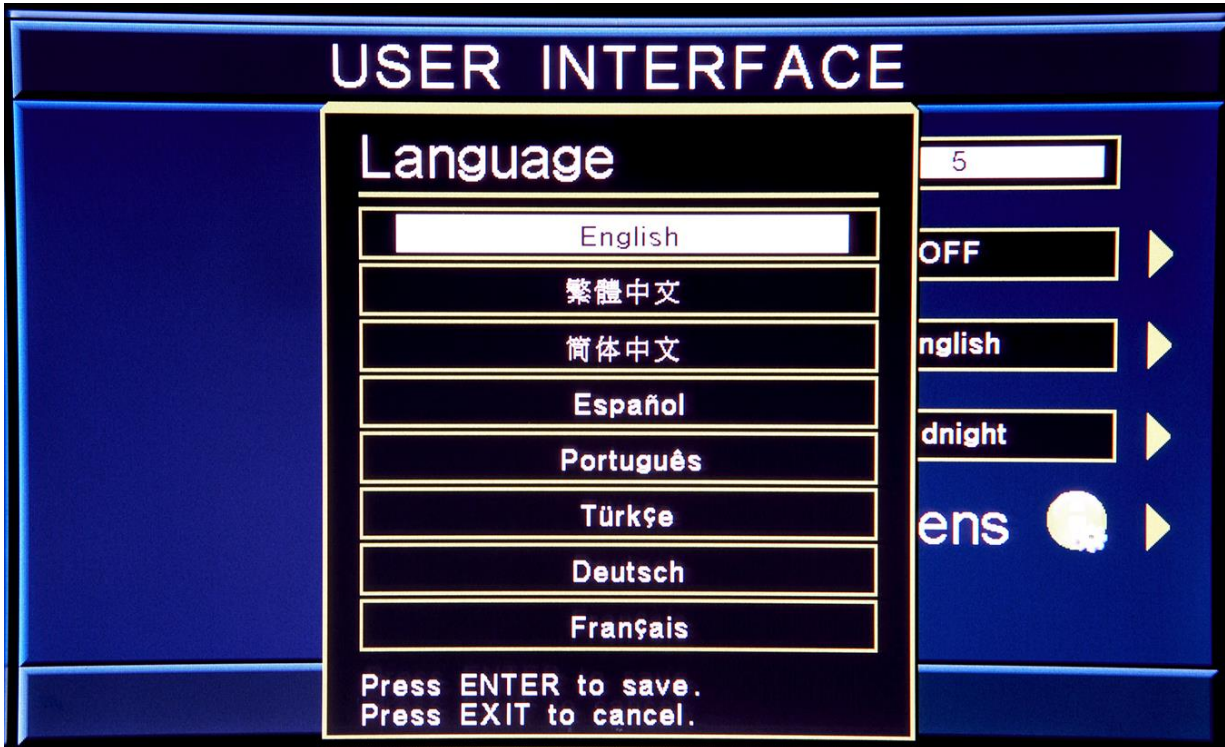

Use the up or down arrow keys to select the preferred language setting for the unit. The language options are English, Traditional Chinese, Simplified Chinese, Spanish, Portuguese, Turkish, German and French.

Once a parameter is edited, it is necessary to complete the edit either by pressing the ENTER key to accept the new value or the EXIT key to escape from the edit and return to the original value.

Color Style

From the User Interface screen, press the “Color Style” soft key. As the soft key is pressed, the “Color Style” pop up screen will appear as follows:

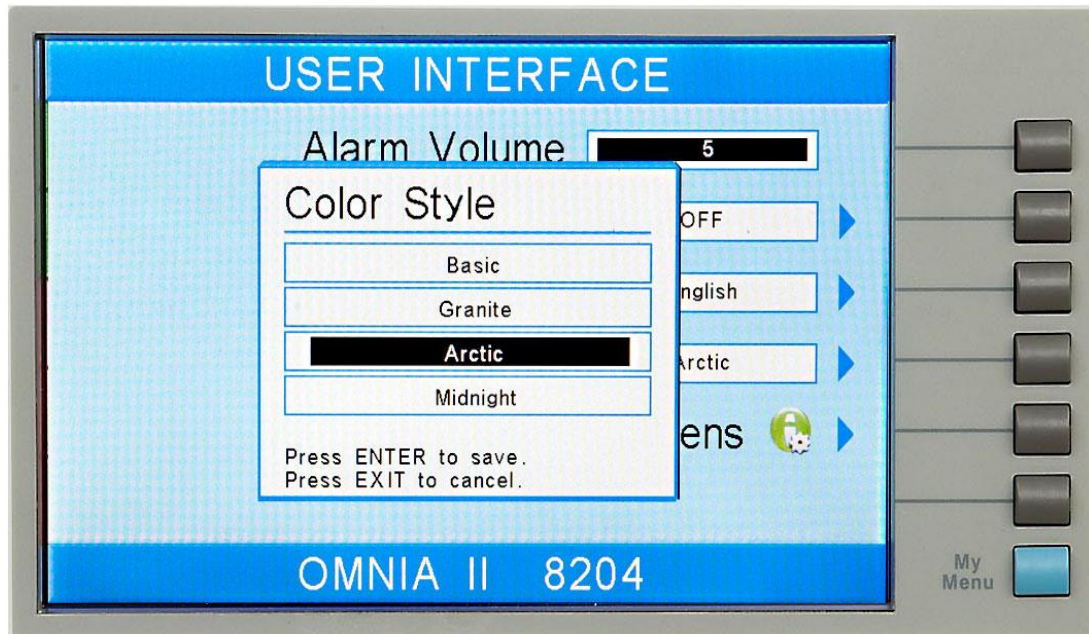

Use the up or down arrow keys to select the preferred color style setting for the unit. The color style setting options are Basic, Granite, Arctic and Midnight.

Once a parameter is edited, it is necessary to complete the edit either by pressing the ENTER key to accept the new value or the EXIT key to escape from the edit and return to the original value.

Reverting to English

If the OMNIA II's interface has been set to Chinese and needs to be configured for English the following steps may be followed:

- 1.) Turn the instrument ON. The home screen will be displayed:

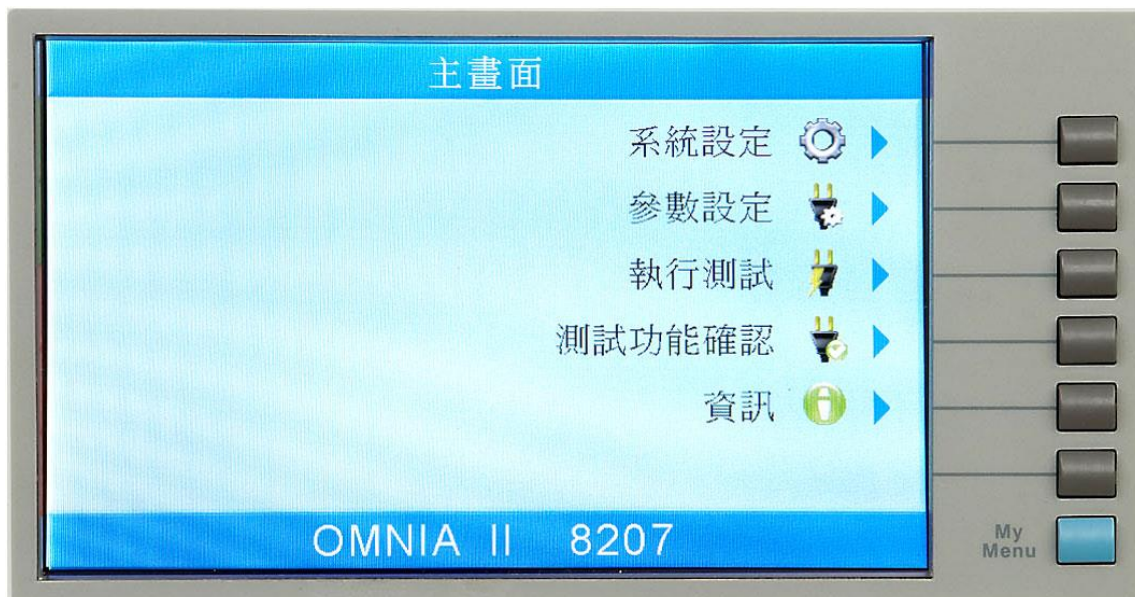

2.) Press the “System Settings” soft key.

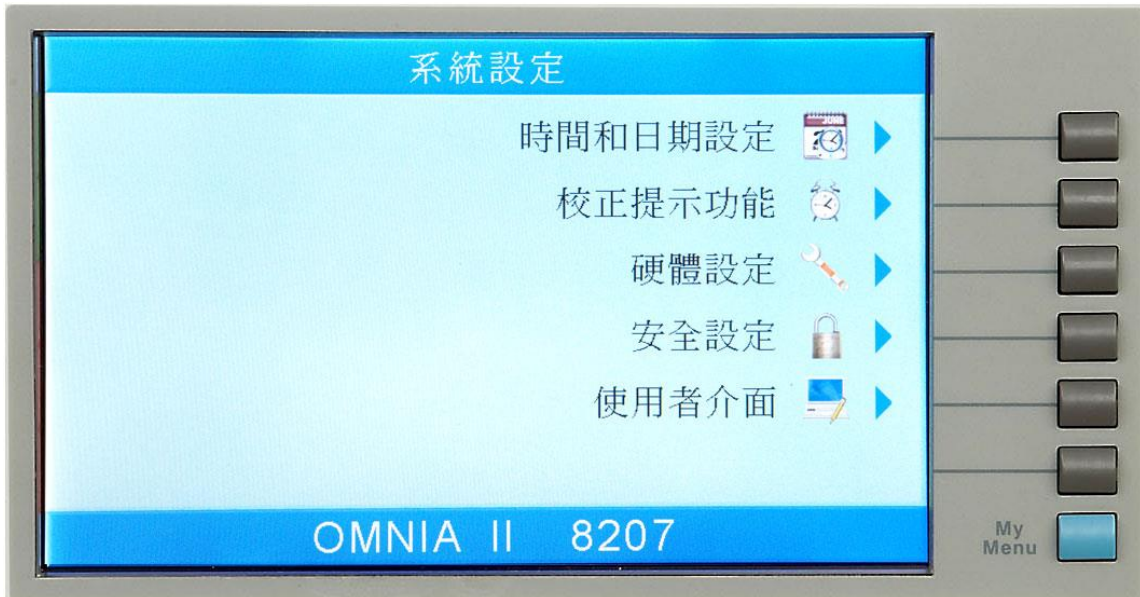

3.) Press the “User Interface” soft key.

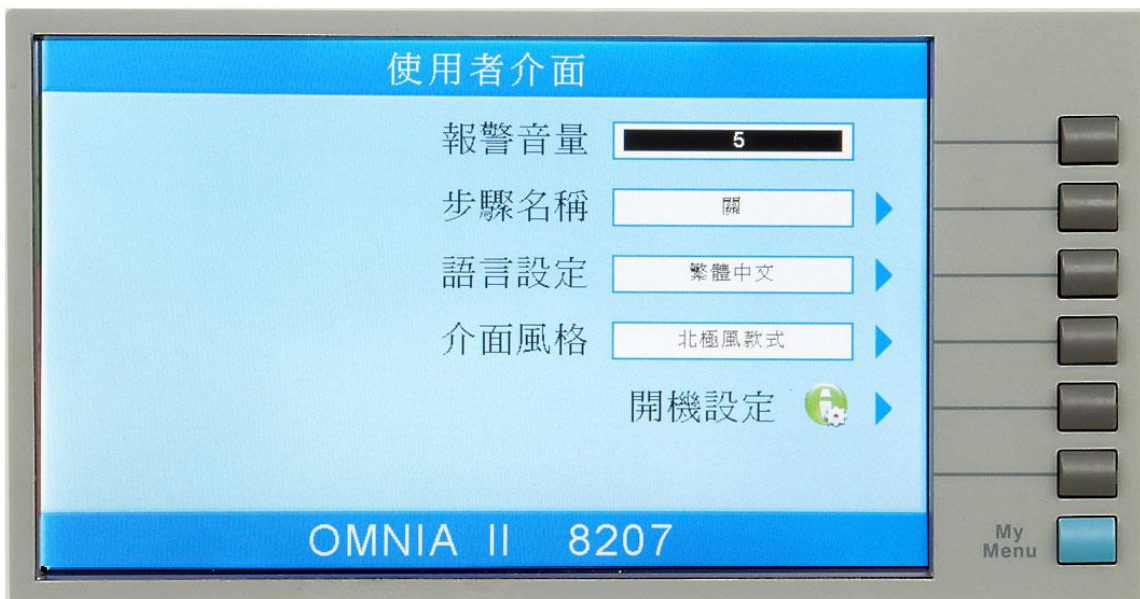

4.) Use the up arrow key to scroll to the English setting.

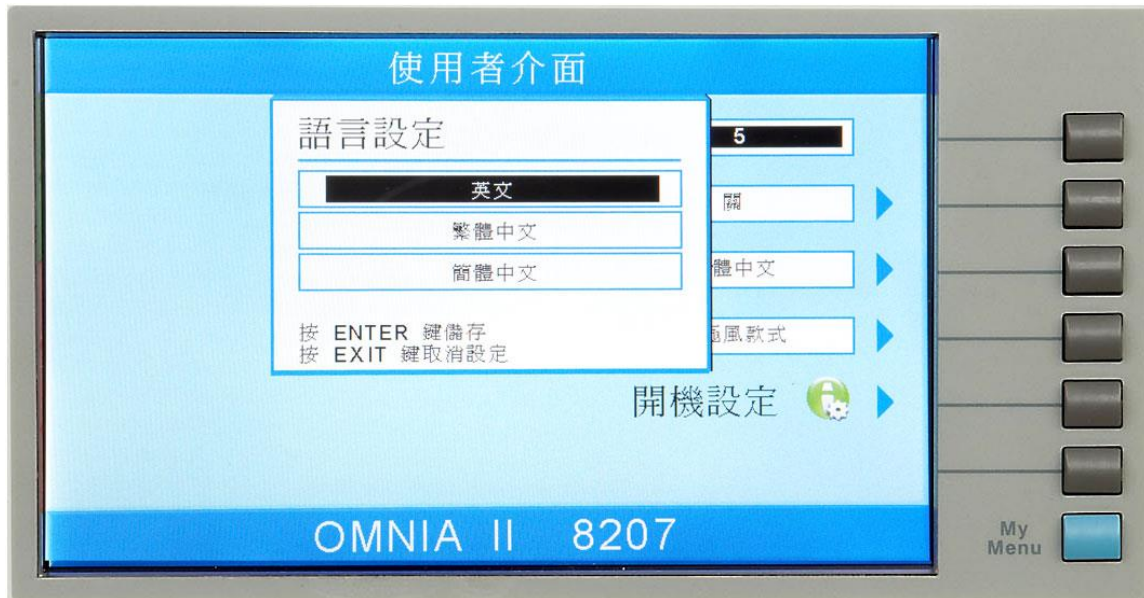

5.) Press the Enter key to confirm.

4.2.7. Power-On Screen

You may configure the OMNIA to power-on at the Main Menu screen, the Perform Tests screen or the My Menu screen. From the User Interface screen, press the "Power-On Screens" soft key. The Power-On Setting screen will now be displayed. From the Power-On Setting screen, two different parameters may be accessed: Animation and Home Screen. The Power-On Screens will appear as follows:

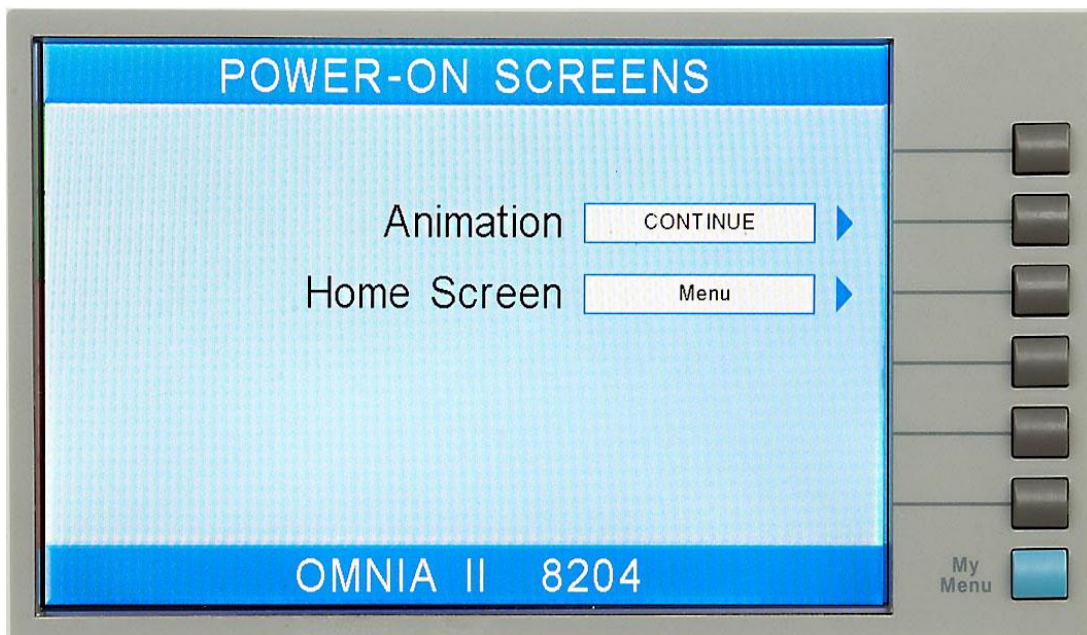

Animation

The OMNIA Animation screen is the very first screen to appear when the instrument is powered up. You have the option to PAUSE the instrument at this screen after power

up or CONTINUE through to the next screen after the Animation screen is displayed for four seconds or SKIP the Animation screen completely. The option to PAUSE, CONTINUE or SKIP may be selected by pressing the “Animation” soft key. When PAUSE is selected, the words “Press any key to continue” will appear at the bottom of the OMNIA Animation screen.

From the Power-On Screens, press the “Animation” soft key. As the soft key is pressed, the “Animation” pop up screen will appear as follows:

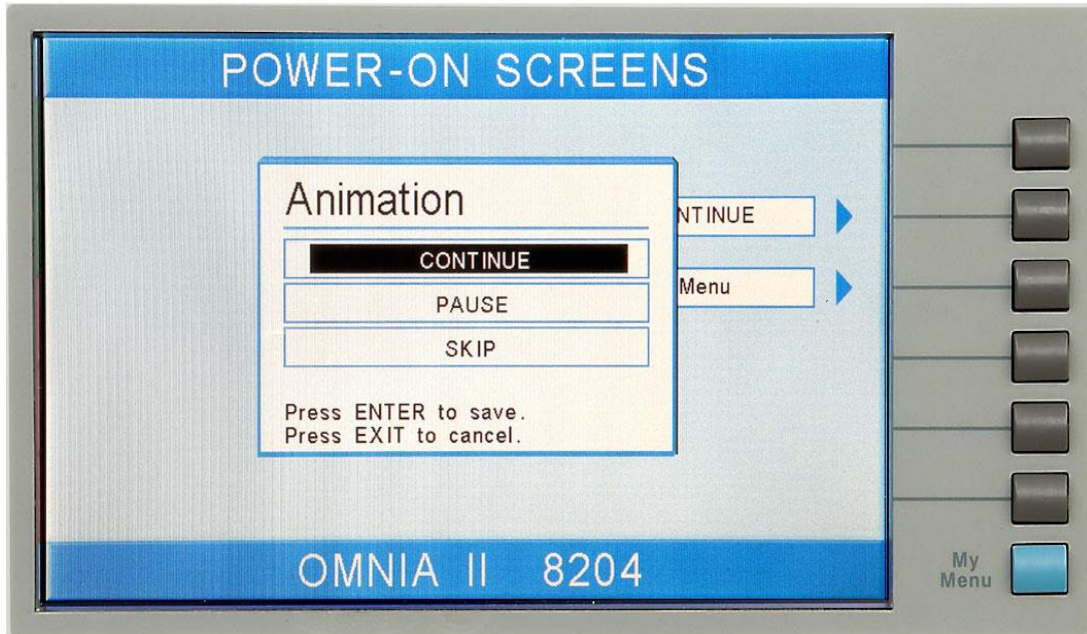

Use the up or down arrow keys to select the preferred animation setting for the unit. The animation setting options are Continue, Pause and Skip.

Once a parameter is edited, it is necessary to complete the edit either by pressing the ENTER key to accept the new value or the EXIT key to escape from the edit and return to the original value.

Home Screen

The Home Screen parameter allows you to select the first screen to appear on the OMNIA after the Animation screen. If the Animation screen is set to Skip, the selected Home Screen parameter will be the first screen to appear upon power up.

From the Power-On Screens, press the “Home Screen” soft key. As the soft key is pressed, the “Home Screen” pop up screen will appear as follows:

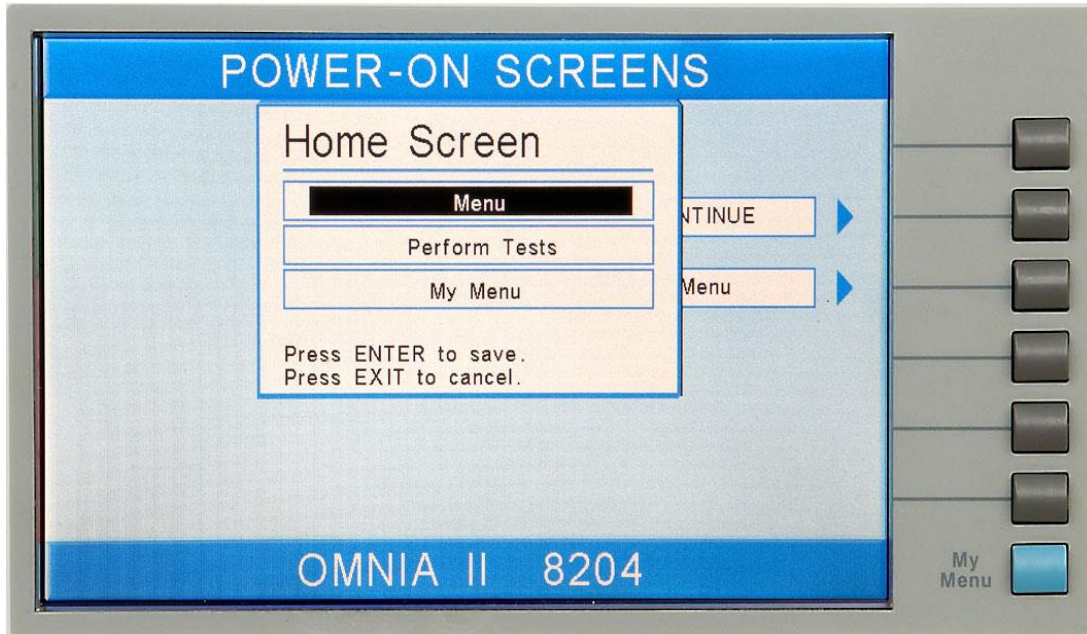

Use the up or down arrow keys to select the preferred home screen setting for the unit. The home screen setting options are Menu, Perform Tests and My Menu.

Configure OMNIA to go directly to the Perform Test screen

1. Set OMNIA Animation to CONTINUE or SKIP.
2. Set the Home Screen selection to Perform Tests. Now when the instrument is powered on it will go directly to the Perform Test screen.

4.3. Setup Tests Menu

From the Main Menu screen press the “Setup Tests” soft key. The Setup Tests screen will now be displayed. From the Setup Tests screen, six different software controls may be accessed: Add, Edit, Delete, Prompt, File, and Fail Stop. The Setup Tests screen will appear as follows:

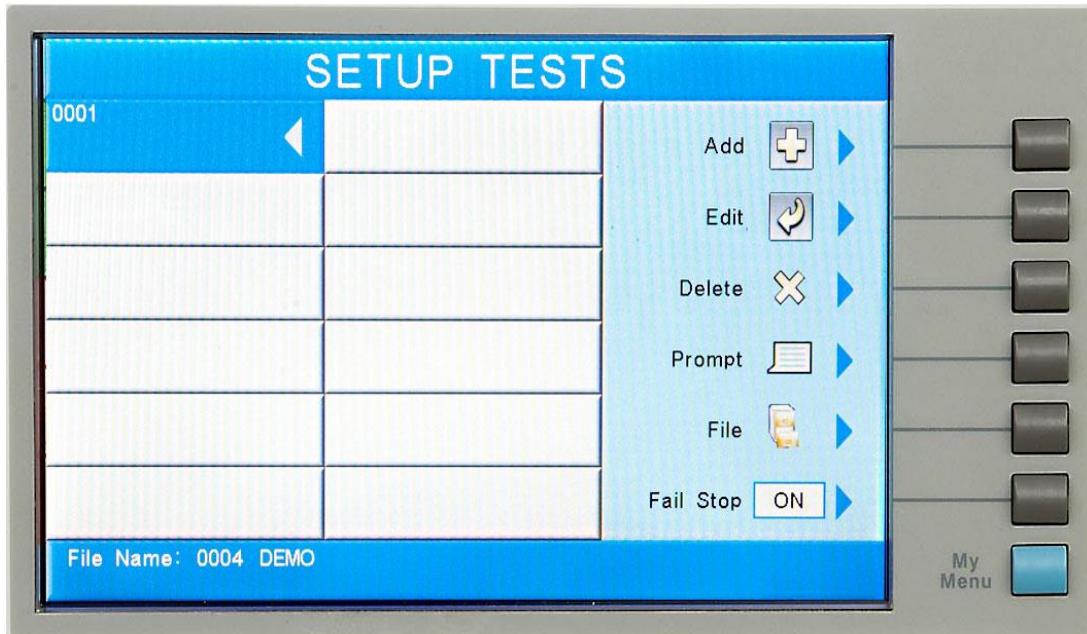

The Setup Tests screen is the central starting point for programming tests into the instrument. From this screen, test parameters are entered and edited, and the order of the test steps can be arranged and then stored to test files. The OMNIA is capable of performing a 10,000-step sequential test from a single test file.

The Setup Tests screen is separated into two main sections. The left half of the screen lists the steps and the parameters contained within each step. The right half of the screen contains the soft key menu. When more than 12 steps are programmed in a test file, the left and right arrow keys will page through the screens of steps. Individual steps may be scrolled to using the up and down arrow keys.

4.3.1. Add

From the Setup Tests screen, press the “Add” soft key. The Test Selection screen will now be displayed. From this screen you may select what type of test you wish to add to a test sequence: Dielectric Withstand, Insulation Resistance, AC Ground Bond, DC Continuity, Run Test and Leakage Current . The Test Selection screen will appear as follows:

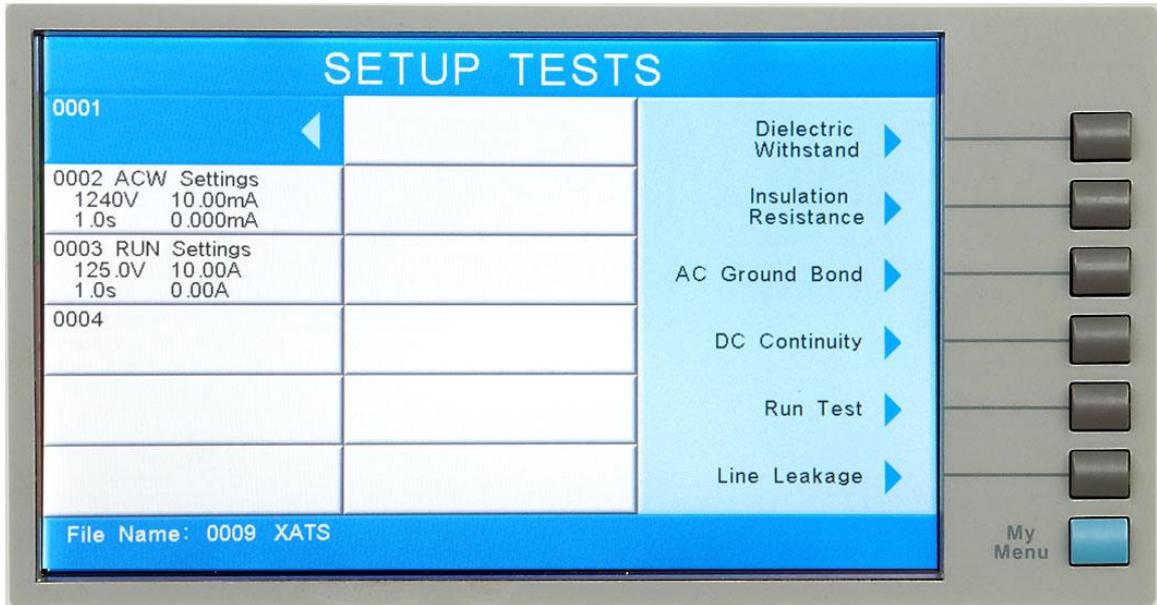

For a detailed description of how to set up a test sequence, please refer to section **4.5. Setting Up a Test.**

For a detailed description of the screens and parameters that are associated with test selection soft keys on this screen please refer to section **4.4. Test Parameters.**

4.3.2. Edit

From the Setup Tests screen, use the up, down arrow keys, and scroll the highlighted area to the step you wish to edit. Press the “Edit” soft key. The Parameter Setting screen for the type of test that is in that location will now be displayed. The parameters for the test may now be edited.

For a detailed description of the screens and parameters that are associated with the “Edit” soft key on this screen please refer to section **4.4. Test Parameters.**

4.3.3. Delete

From the Setup Tests screen, use the up and down arrow keys to scroll the highlighted area to the step you wish to delete. While pressing the Delete soft key, a pop will appear to confirm the step deletion:



Press ENTER to confirm and delete the selected step or EXIT to cancel and return to the Setup Tests screen.

4.3.4. Prompt

The Prompt function allows you to insert a short line of text in a step. The Prompt will appear on the screen before the step is initiated and remain on the screen until the TEST button is pressed. After the TEST button is pressed, the Prompt will clear and the step will initialize. Use the up and down arrow keys to scroll the highlighted area to the step where you would like to insert the text prompt and press the “Prompt” soft key. The Prompt screen will now be displayed. The Prompt screen will appear as follows:

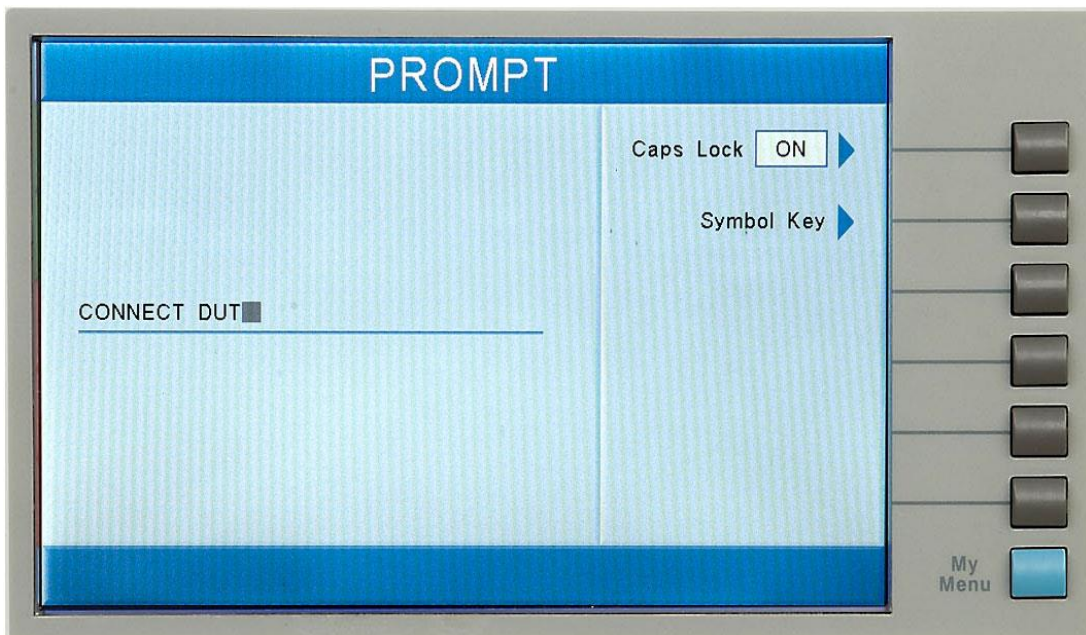

To enter a text prompt, use the alphanumeric keypad. At the text prompt edit, the letter or symbol will be inserted at the point where the cursor is flashing. The cursor will then increment to the next position and wait for an additional character insertion. If you make a mistake or want to change the character, press the backspace key in the alphanumeric keypad. The cursor will decrement and erase the character. If you wish to use capital letters in the prompt, press the “Caps Lock” soft key. While pressing the Caps Lock soft key, the Caps Lock parameter will toggle between ON and OFF. If you wish to use symbols in the prompt, press the “Symbol Key” soft key. While pressing the Symbol Key soft key, the symbol values will toggle between !, *, _, - and ~.

When you have finished editing the prompt press the ENTER key. After a prompt is inserted in a step, a “P” will appear within the step parameters below the step number.

4.3.5. File

From the Setup Tests screen, press the “File” soft key. The File Setup screen will now be displayed. From the File Setup screen, five different file-handling controls may be accessed: New File, Save, Save As, Delete, and Load. The File Setup screen will appear as follows:

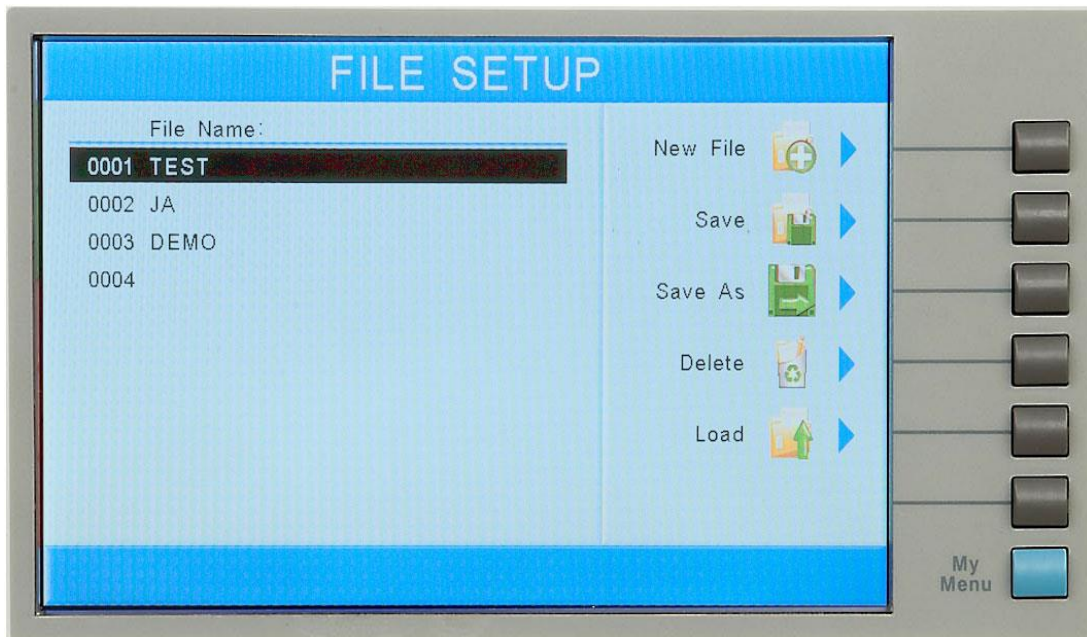

New File

From the File Setup screen, press the “New File” soft key. The Create File screen will now be displayed. For a detailed description of creating a new file, refer to the section **4.5. Setting Up a Test**. The Create File screen will appear as follows:

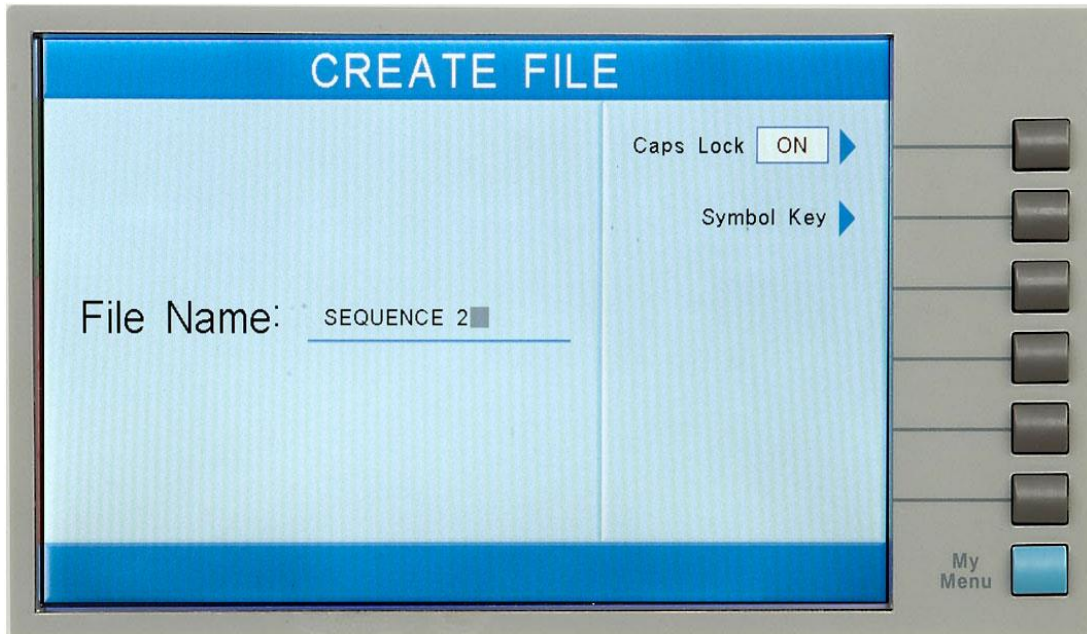

Save

To save a file with its current name press the “Save” soft key from the File Setup screen.

Save As

To save an edited file without overwriting the original or to give a file a new name, press the “Save As” soft key from the File Setup screen. The Create File screen will now be displayed. For a detailed description of creating a new file, refer to the section **4.5. Setting Up a Test.**

Delete

To delete a file, use the up and down arrow keys and scroll the highlighted area to the file you wish to delete and press the “Delete” soft key. A warning will appear on the screen asking if you want to delete the file. Press the ENTER key to complete the deletion or press the EXIT key to escape.

Load

To load a test file, use the up and down arrow keys and scroll the highlighted area to the file you wish to load and press the “Load” soft key.

4.3.6. Fail Stop

Fail Stop is a function that will stop a sequence of tests if a failure occurs. If this function is turned OFF the sequence of tests will continue to the end of the sequence regardless of whether or not a failure has occurred. If the Fail Stop is OFF and a failure occurs during the test sequence, the RESET button will light and a short alarm will sound but the sequence will continue. At the end of the test sequence, the RESET button will light and alarm will sound indicating failure during the sequence. Pressing the RESET button will silence the alarm and reset the instrument.

Turn the Fail Stop function ON and OFF by pressing the “Fail Stop” soft key. Fail Stop is a parameter that is stored within the test file but may also be turned ON and OFF temporarily from the Perform Tests screen. If security is enabled you may not turn Fail Stop ON and OFF using the “Fail Stop” soft key. Fail Stop automatically defaults to the setting stored in the file when security is activated.

Fail Stop with Run and Leakage Current tests

Associated Research recommends performing a Hipot test with the Fail Stop ON prior to performing a Run Test or Leakage Current test. Performing a Hipot test first can detect if a DUT is shorted line to ground before applying line power to it.

4.4. Test Parameters

From the Setup Tests screen, press the “Add” soft key. The Test Selection screen will now be displayed. From this screen, you may choose what type of test to perform: Dielectric Withstand, Insulation Resistance, AC Ground Bond or DC Continuity. If you have model 8206 or 8207, you will have Leakage Current and Run Test selections. The Tests Selection screen will appear as follows:

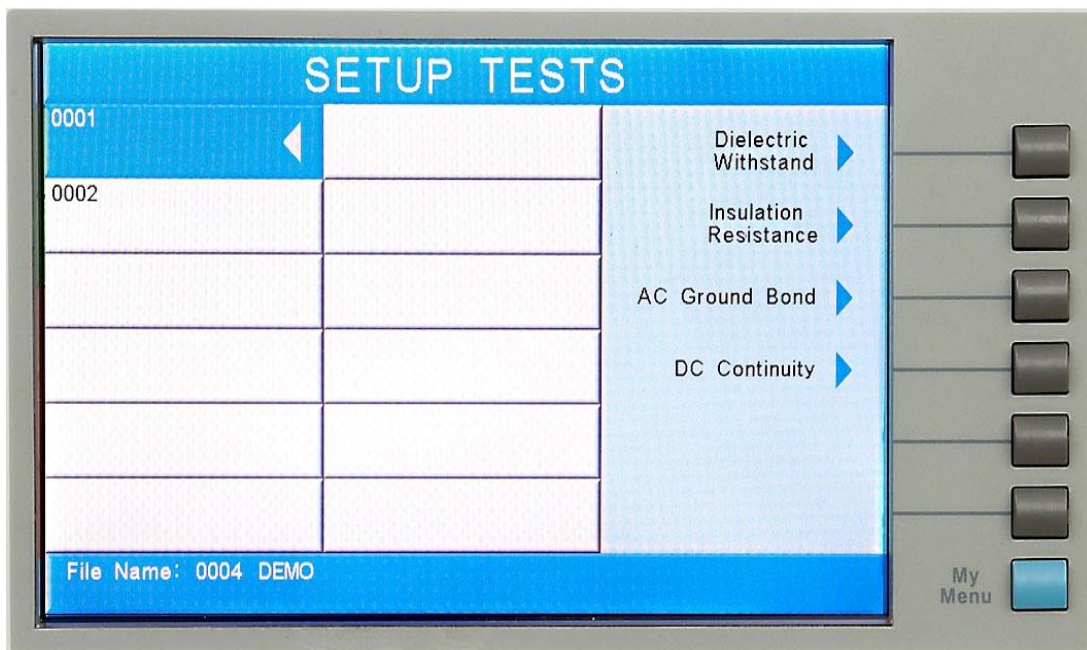

4.4.1. Description of Test Parameters

Voltage: The voltage that is applied to the high voltage and return terminals during a test.

Voltage-HI: The voltage high limit that will cause a failure if exceeded during a RUN test.

Voltage-LO: The voltage low limit that will cause a failure if not exceeded during a RUN test.

Amp-HI: The current high limit that will cause a failure if exceeded during a RUN test.

Amp-LO: The current low limit that will cause a failure if not exceeded during a RUN test.

Power-HI: The power high limit that will cause a failure if exceeded during a RUN test.

Power-LO: The power low limit that will cause a failure if not exceeded during a RUN test.

PF-HI: The power factor high limit that will cause a failure if exceeded during a RUN test.

PF-LO: The power factor low limit that will cause a failure if not exceeded during a RUN test.

Current: The Current that is applied between the Current and Return lead during a ground bond test.

Current-HI: The maximum allowable current-flow through the DUT that triggers a failure when exceeded.

Current-LO: The minimum allowable current-flow through the DUT triggers a failure when not exceeded.

Leakage-HI: The maximum leakage current allowable through the measuring device that triggers a failure when exceeded.

Leakage-LO: The minimum leakage current allowable through the measuring device that triggers a failure when not exceeded.

HI-Limit: A maximum threshold set point that when exceeded triggers a failure. A "T" or an "R" designator is shown in AC withstand parameters and means, "T" total current or "R" real current.

LO-Limit: A minimum threshold set point that when not exceeded triggers a failure. A "T" or an "R" designator is shown in AC withstand parameters and means, "T" total current or "R" real current.

Ramp Up: The length of time that is allowed for the test voltage to climb from 0 to the programmed test voltage.

Dwell Time: The length of time that is allowed for the programmed test voltage to be applied.

Delay Time: The length of time that the programmed test voltage is applied but no judgment of the set parameters is made. Judgment of the parameters is not made until the end of the delay time.

Ramp Down: The length of time that is allowed for the test voltage to decay from programmed test voltage to 0.

Arc Sense: During hipot testing some low current arcing may be allowable. Arc sense is a maximum allowable threshold for arcing.

Arc Detect: If the Arc Fail mode is set to ON, the program will indicate an arc failure when the arc current is exceeds this setting. Arc Detect may be selected ON or OFF using a soft key.

Ramp-HI: The Ramp-HI function is active during the Ramp period only. Ramp-HI will allow current higher than the normal Max-Lmt current setting of the DC Withstand Voltage test to avoid false failure due to charging current.

Charge-LO: The Charge-LO function is used to check if the cables are connected properly at the beginning of a test. This function is only available in DC Withstand and Insulation resistance testing. A description of how to set up this parameter is given in the **4.5.2. DC Withstand** and **4.5.3. Insulation Resistance** parameter sections of this manual.

Offset: This function allows the instrument to compensate for lead and test fixture resistance during a Ground Bond or Continuity test. A description of how to set up this parameter is given in **the 4.5.4. Continuity** and **4.5.5. Ground Bond** parameter sections of this manual.

Frequency: This parameter is available in AC tests only and is selectable using a soft key between 50 and 60Hz.

Continuity in ACW and DCW: This function checks for a connection between the current and return lead. This is a basic DC continuity check and will not disclose a Continuity value. Continuity may be selected ON or OFF using a soft key in the ACW and DCW parameters.

Scanner Setup: (This parameter will only be seen on units equipped with a scanner). This parameter allows for set up of the Scanner channels. The three different selectable scanner states are: L (scanner channel set to the return point), H (scanner set to the high voltage point) and O (OFF).

AC Source: This parameter is available in Leakage Current and RUN testing and is used to enter the menu to control the AC Source's test parameters. The AC Source's test parameters include: Voltage, Frequency, A-Hi (current high limit), Output N/G, Voltage Range, and OC-Fold.

Active Link: When active, the Active Link feature keeps the DUT powered from one Leakage Current test to another, from one Functional Run test to another, and in between Leakage Current and Functional Run test steps.

Select Meter: This parameter allows you to select the meter orientation during testing.

Step Name: This parameter allows you to enter a text name for each step.

Leakage: This parameter allows you to measure leakage using either Peak or RMS measurements.

Neutral: This parameter controls the Neutral relay during Leakage Current testing.

Reverse: This parameter controls the Reverse relay during Leakage Current testing.

Ground: This parameter controls the Ground relay during Leakage Current testing.

Measure Device: This parameter allows you to select the MD used during Leakage Current testing.

Probe: This parameter allows you to set the probe configuration during Leakage Current testing.

AC/DC: The metered value of leakage current during a Leakage Current test. Can be set to AC+DC, AC or DC. When set to AC+DC, the unit measures the composite leakage current through the MD. When set to AC, the unit measures only the AC component of the leakage current through the MD. When set to DC, the unit measures only the DC component of the leakage current through the MD*.

- **NOTE:** If the AC/DC parameter is set to DC or AC, the minimum delay time is automatically set to a minimum of 1.3sec. If the AC/DC parameter is set to AC+DC, the minimum delay time is automatically set to a minimum of 1.8sec.

Ranging Mode: Unit ranging setting used during the Leakage Current test. Can be set to Auto or Manual.

Defaults: Pressing this soft key will default the test parameters to their predetermined default values (refer to section **4.4.2. Default Parameters**). Once the default soft key is pressed it is necessary to complete the edit either by pressing the ENTER key to accept the parameter overwrite or the EXIT key to escape from the edit and return to the original values.

DUT Output (82x6 and 82x7): This function enables or disables high voltage at the DUT outputs during an AC Withstand, DC Withstand, or IR test. The DUT Output parameter will only be present if the DUT-HV Setup is selected ON at the Hardware screen. The DUT Output parameter will appear on the AC Withstand, DC Withstand, or IR test parameter screens as follows:

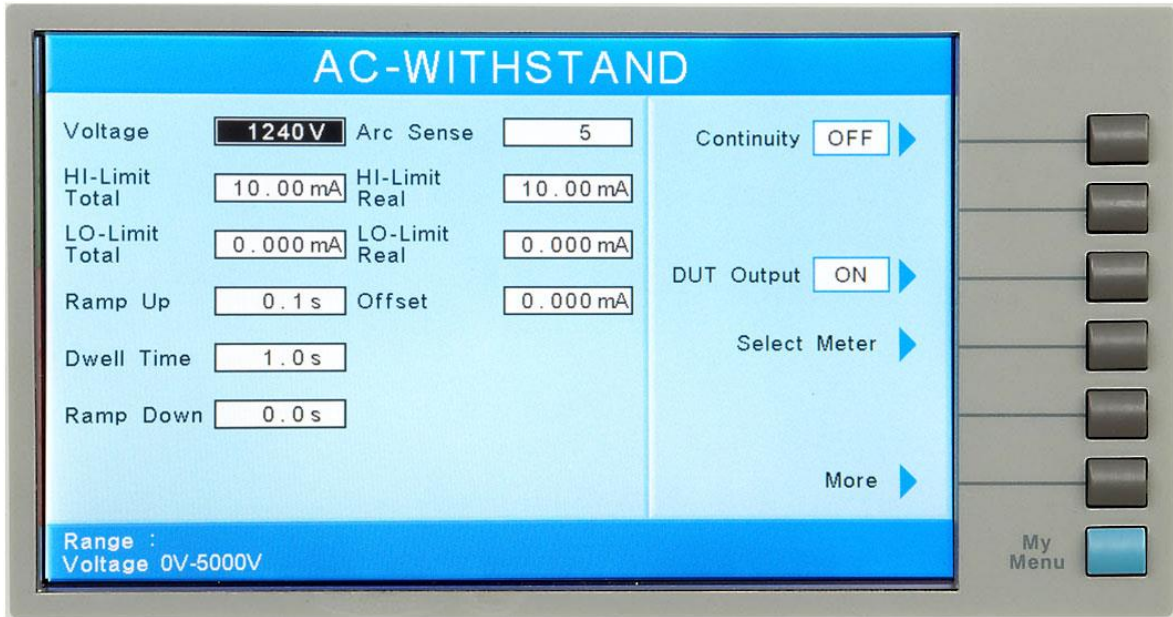

4.4.2. Default Test Parameters

In each of the Test Parameter Setting screens there is a “Defaults” soft key. When this key is pressed the test will load with a set of predetermined Default Parameters. The following table is a listing of the Default Parameters for each of the different types of tests that are available in the OMNIA II. The Default Parameters are as follows:

Default Parameters

TEST TYPE	PARAMETER	VALUE
ACW	Voltage	1240VAC
	HI-Limit T	10.00mA
	LO-Limit T	0.000mA
	Ramp Up	0.1s
	Dwell Time	1.0s
	Ramp Down	0.0s
	Arc Sense	5
	HI-Limit R	10.00mA
	LO-Limit R	0.000mA
	Offset	0.000mA
	Scanner	OOOOOOOOOOOOOOOOOO
	Frequency	60Hz
	Arc Detect	OFF
	Continuity	OFF

TEST TYPE	PARAMETER	VALUE
DCW	Voltage	1200VDC
	HI-Limit	10000 μ A
	LO-Limit	0.0 μ A
	Ramp Up	0.4s
	Dwell Time	1.0s
	Ramp Down	1.0s
	Charge-LO	0.0 μ A
	Arc Sense	5
	Offset	0.0 μ A
	Scanner	00000000000000000000
	Ramp-HI	OFF
	Arc Detect	OFF
	Continuity	OFF
IR	Voltage	500VDC
	HI-Limit	0.00M Ω
	LO-Limit	0.05M Ω
	Ramp Up	0.1s
	Dwell Time	0.5s
	Delay	1.0s
	Ramp Down	0.0s
	Charge-LO	0.000 μ A
	Scanner	00000000000000000000
GND	Current	25.00A
	Voltage	8.00V
	HI-Limit	100m Ω
	LO-Limit	0m Ω
	Dwell	1.0s
	Frequency	60Hz
	Offset	0m Ω
	Scanner	00
	DualCHEK	OFF
CONT.	HI-Limit	1000 Ω
	LO-Limit	0.00 Ω
	Dwell	1.0s
	Offset	0.00 Ω
	Scanner (GND Channel)	00
	Scanner (HV Channel)*	00000000000000000000

TEST TYPE	PARAMETER	VALUE
Setup Sys.	PLC Remote	OFF
	Address (GPIB only)	8
	Measurement	True RMS
	Language	English
	Volume	5
	Step Name	OFF
	Color Style	Arctic
	Smart GFI	0.4mA
Security	User ID	Admin
	Password	8000
	Security	OFF
MODELS 82X6 AND 82X7		
Run Test	Voltage-HI	100.0V
	Voltage-LO	0.0V
	Amp-HI	10.00A
	Amp-LO	0.00A
	Dwell Time	1.0s
	Delay Time	0.1s
	Leakage-HI	10.00mA
	Leakage-LO	0.00mA
	Power-HI	1000W
	Power-LO	0W
	PF-HI	1.000
	PF-LO	0.000
	Active Link	OFF
	MODEL 82X6 AND 82X7	
LCT	Leakage-HI	3000 μ A
	Leakage-LO	0.0 μ A
	Voltage-HI	100.0V
	Voltage-LO	0.0V
	Dwell Time	1.0s
	Delay Time	1.0s
	Offset	0.0 μ A
	Leakage	RMS
	Active Link	OFF
	Reverse	OFF
	Neutral	CLOSED
	Ground	CLOSED
	Meas. Device	UL544NP
	Probe	Ground to Line
	AC/DC	AC+DC
	Ranging Mode	Auto
Scanner	00000000000000000000	

● **NOTE:** Scanner setup depends upon the Continuity Scanner setting. See section **4.2.4 Hardware** for more details on the Continuity Scanner setting.

4.5. Setting Up a Test

Upon power up, OMNIA will initialize with the test file that was last used before power down. If the instrument is new it will come loaded with one default file that the instrument will boot up with until it is changed.

1. From the Setup Tests screen, press the “File” soft key. The File Setup screen will now be displayed.
2. From the File Setup screen, press the soft key “New File”. The Create File screen will now be displayed.
3. The Create File screen is separated into two main sections: File Name Edit and Soft Key Menu.
4. From the Create File screen you must give your new test file a name. The file name can be a maximum of fifteen characters in length and may use any combination of the character set plus numbers and symbols. To name your file, use the alphanumeric keypad. If you make a mistake or want to change the character, press the backspace key in the alphanumeric keypad. If you wish to use capital letters in the prompt, press the “Caps Lock” soft key. While pressing the Caps Lock soft key, the Caps Lock parameter will toggle between ON and OFF. If you wish to use symbols in the prompt, press the “Symbol Key” soft key. While pressing the Symbol Key soft key, the symbol values will toggle between !, *, _, - and ~. When you have finished editing the file name press the ENTER key.
5. From the Setup Tests screen, press the “Add” soft key. The Test Selection screen will now be displayed. From this screen you may choose what type of test to perform: Dielectric Withstand, Insulation Resistance, AC Ground Bond or DC Continuity.
6. From the Test Selection screen, press the soft key next to the type of test you wish to add to the test sequence. If you press the “Dielectric Withstand” soft key, the AC-Withstand and DC-Withstand test soft keys will be displayed. Press the AC-Withstand or DC-Withstand soft key to choose a dielectric withstand test type. The Parameter Setting screen for the type of test you have chosen will now be displayed.
7. From Parameter Setting screen you may set your own custom parameters for the test or choose the defaults from the soft key menu. All of the individual parameters for the test may be accessed using the up and down arrow keys, and the ENTER key. As the arrow keys are pressed, the highlighted area will scroll to the different parameters. The ENTER key may also be used to scroll to the different parameters. At the bottom of the screen is the Scanner Setup parameter (for a detailed explanation of how this feature works, refer to the section **5.1.5. Scanner Connections**).
8. Scroll to a parameter you wish to edit. The parameter that is highlighted may now be edited (refer to section **4.4. Test Parameters**). Enter a new number via the alphanumeric keypad. Once you begin typing a new number the parameter will blank and the cursor will begin blinking. This indicates that the parameter is being edited. Once a parameter is edited it is necessary to complete the edit either by pressing the ENTER key to accept the new number or the EXIT key to

- escape from the edit and return to the original number.
9. Press the EXIT key to “Add” this test to the sequence of tests. The Setup Tests screen will now be displayed again, this time with the new parameters.
 10. At this point, you may add more tests to the sequence, insert tests, insert prompts, perform the test sequence, or store the sequence to the file name you created.

Test Parameter Notes

- Once you begin typing a new number, the parameter will go blank and the cursor will begin blinking. This indicates that the parameter is being edited. Once a parameter is edited, it is necessary to complete the edit either by pressing the ENTER key to accept the new number or the EXIT key to escape from the edit and return to the original number. The one exception to this rule is the Scanner parameter. The Scanner parameter will not go blank when being edited.
- When the ENTER key is pressed to accept a parameter change, the instrument will automatically bring up the next Test Parameter Edit screen.
- The Test Parameter Edit screen displays the Range of the parameter that is highlighted. Use this as a guide when setting your parameters.
- The soft keys in the Parameter Menus select different conditions and no data entry is required, i.e. the “Frequency” soft key in the AC Withstand displays a Frequency pop up screen that allows for choices between 50Hz, 60Hz or Sync. It is necessary to press the ENTER key to accept the new parameter or press EXIT to cancel from the edit.
- If the “Step Name” parameter is enabled in the System Menu, then each step will have a “Step Name” soft key in the Parameter Menus. The step name can be a maximum of 24 characters in length and may use any combination of the character set plus numbers and symbols. To name the step, use the alphanumeric keypad. If you make a mistake or want to change the character, press the backspace key in the alphanumeric keypad. The cursor will decrement and erase the character. If you wish to use capital letters in the prompt, press the “Caps Lock” soft key. While pressing the Caps Lock soft key, the Caps Lock parameter will toggle between ON and OFF. If you wish to use symbols in the prompt, press the “Symbol Key” soft key. While pressing the Symbol Key soft key, the symbol values will toggle between !, *, _, - and ~. When you have finished editing the file name press the ENTER key.
- Selecting the test type (ACW, DCW, and IR) automatically loads the default parameters for that particular type of test. Refer to section **4.4.2. Default Test Parameters** for the preset default parameters.
- Scanner and External scanner parameters will only appear in the Parameter screens if the options are installed.

Adding More Tests to the Sequence

To add more tests to the sequence simply repeat steps 5-10 of this section.

Performing a Test from the Setup Tests screen

To perform the test you have just created press the ENTER key. The Perform Tests

screen will now be displayed along with a pop-up message that appears as follows:

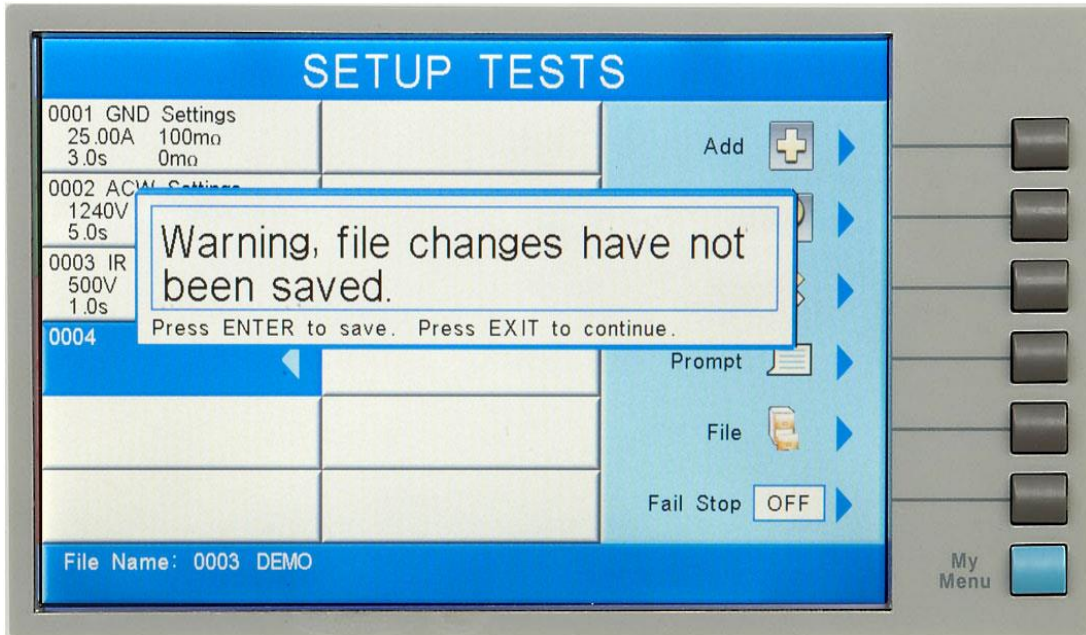

Pressing the ENTER key will store the file with the file name you gave it and go to the Perform Test screen. You may now perform a test (refer to section **5.2. Perform Tests Menu**).

Pressing the EXIT key will return you to the Main Menu without saving the file. Even though the file has not been saved, the file will be retained in RAM until another file is loaded or created, or until the instrument is powered down.

Saving the Test File

From the Setup Tests screen, press the “File” soft key. The File Setup screen will now be displayed.

From the File Setup screen, press the “Save” soft key. The file will save to the name you created and the Setup Tests screen will now be displayed with the new file loaded. While hitting the “Save” soft key, the following pop up will be displayed indicating the file is being saved:

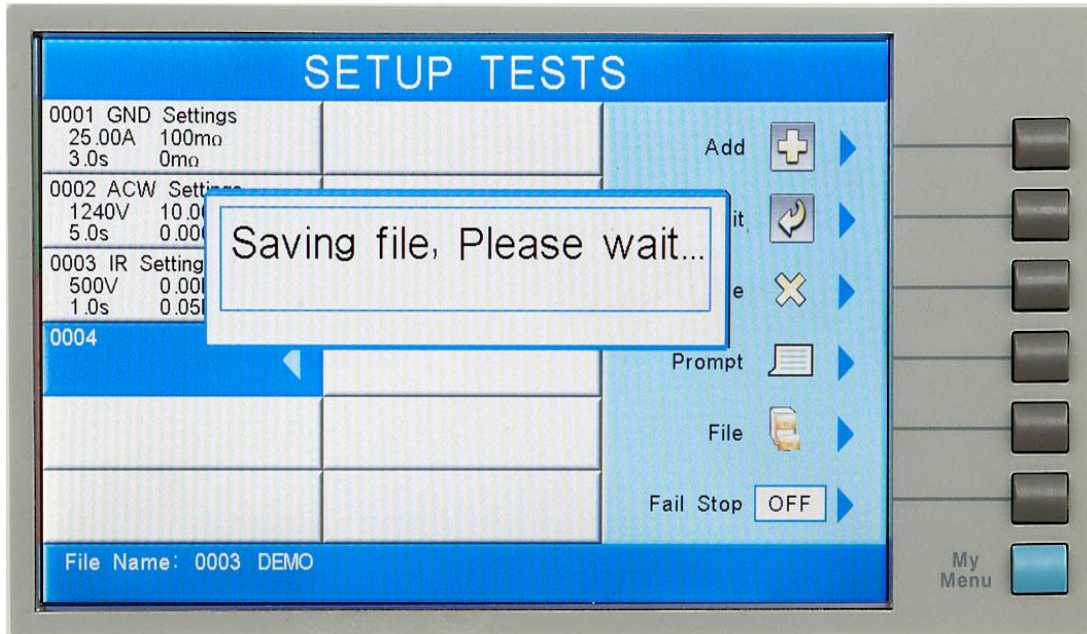

The instrument is now ready to perform tests with the new file. You may now press the ENTER key to go to the Perform Tests screen or press the EXIT key to return to the Main Menu.

Inserting Tests

From the Setup Tests screen, scroll the highlighted area to the step in the sequence where you would like to insert a test.

Press the “Add” soft key. The highlighted area will blank and the test that was originally at this step in the sequence, as well as all of following steps, will increment. At the same time the Setup Test, Tests Selection screen will be displayed.

You may now select the type of test you wish to insert from the soft key menu.

Inserting a Text Prompt

Refer to section 4.3.4. **Prompt** for a detailed description of inserting text prompts.

4.5.1. AC Withstand

From the Setup Tests Selection screen, press the “Add” soft key. The test types soft keys will now be displayed. Pressing the “Dielectric Withstand” soft key will display the “AC-Withstand” and “DC-Withstand” soft keys. Press the “AC-Withstand” soft key. The AC Withstand Parameter Setting screen will now be displayed. The AC Withstand Parameter Setting screen will appear as follows:

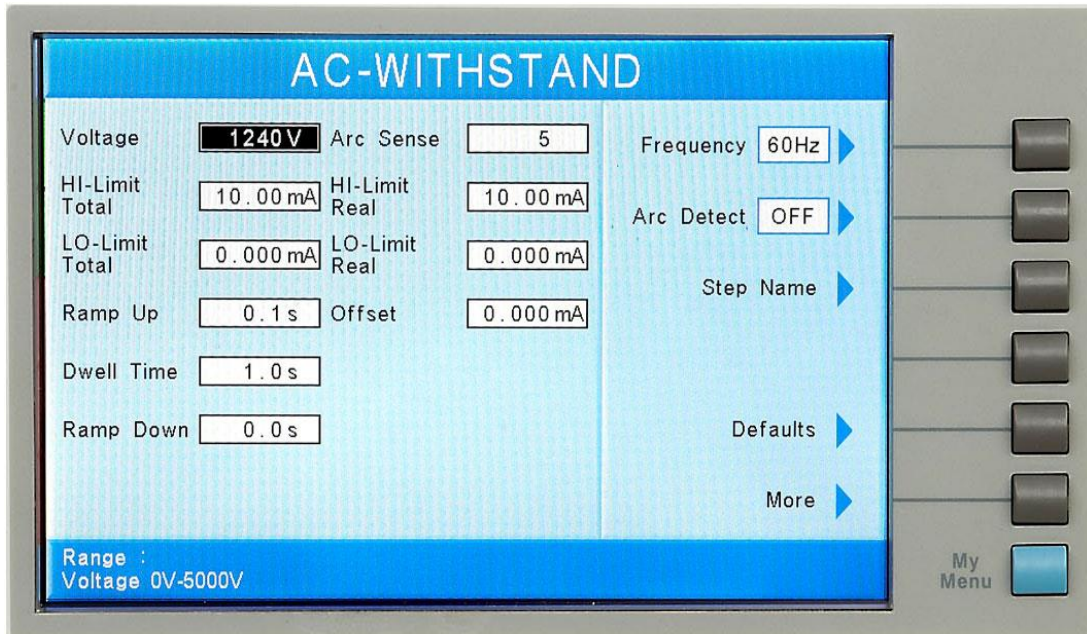

From the AC Withstand Parameter Setting screen the following parameters may be controlled: Voltage, HI-Limit Total, LO-Limit Total, Ramp Up, Dwell Time, Ramp Down, Arc Sense, HI-Limit Real, LO-Limit Real, Offset, Frequency, Arc Detect (ON/OFF), Step Name, Scanner Channel, Defaults and More. Pressing the More soft key will display the additional parameters Continuity selection (DC continuity or OFF) and Select Meter.

4.5.2. DC Withstand

From the Setup Tests Selection screen, press the “Add” soft key. The test types soft keys will now be displayed. Pressing the “Dielectric Withstand” soft key will display the “AC-Withstand” and “DC-Withstand” soft keys. Press the “DC-Withstand” soft key The DC Withstand Parameter Setting screen will now be displayed. The DC Withstand Parameter Setting screen will appear as follows:

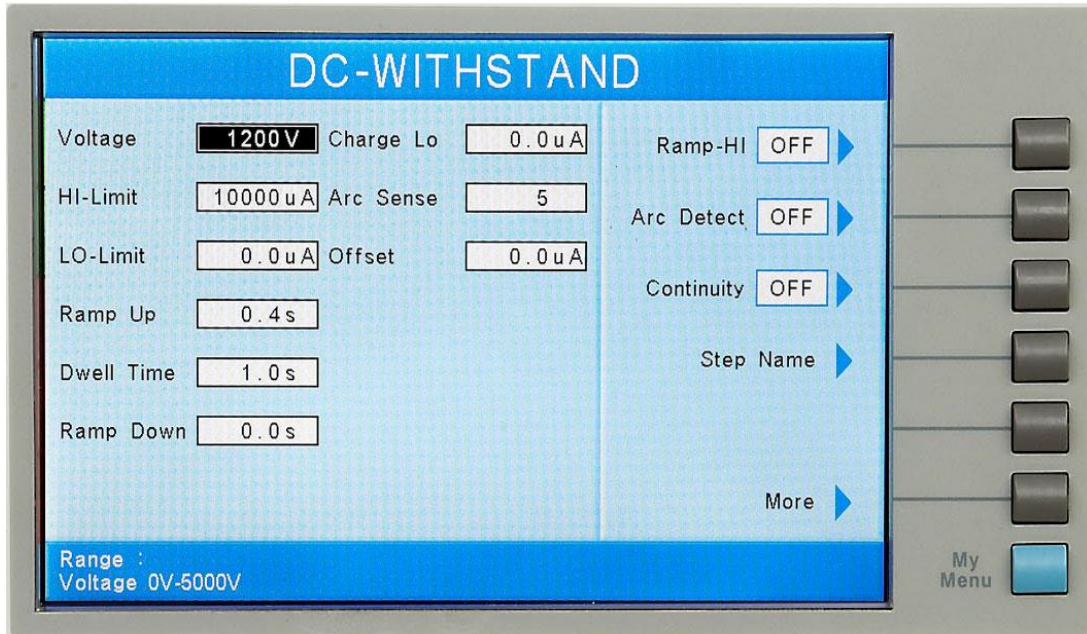

From the DC Withstand Parameter Setting screen the following parameters may be controlled: Voltage, HI-Limit, LO-Limit, Ramp Up, Dwell Time, Ramp Down, Charge-LO, Arc Sense, Offset, Ramp-HI (ON/OFF), Arc Detect (ON/OFF), Continuity (DC continuity or OFF), Scanner Channel, Step Name and More. Pressing the More soft key will display the additional parameter Defaults.

Charge-LO

The Charge-LO function is used to check if the cables are connected properly at the beginning of a test. A capacitive DUT will draw charging current on the DC Withstand Voltage test when the Output is activated. If the charging current is lower than the setting, the test cables may not be connected properly.

The instrument can set the Charge-LO parameter manually or automatically. To manually set the Charge-LO current, use the up and down arrow keys or the ENTER key and scroll the highlighted area to the Charge-LO current parameter. Enter the new Charge-LO current via the alphanumeric keypad and then press the ENTER key to accept the new parameter or press the EXIT key to escape from the edit.

To automatically set the Charge-LO current, use the up and down arrow keys or the ENTER key and scroll the highlighted area to the Charge-LO current parameter. Set the voltage and ramp times to the values that will be used on the DUT and connect the test cables or test fixture between the instrument and DUT. Press the TEST button.

WARNING

Please be aware that the program will activate high voltage on the output connector when the Test button is pressed.

The program will read the charging current of DUT and set the Charge-LO current at approximately one half (1/2) of the reading. The highlighted parameter field will briefly

show the word “READING” and then the display the new value. The new value is automatically updated in the field and does not allow an escape to the original value or require that the ENTER key be used to accept the new parameter.

Ramp-HI

The Ramp-HI function is active during the Ramp period only. Ramp-HI will allow current higher than the normal HI-Limit current setting of the DC Withstand test to avoid false failure due to charging current.

4.5.3. Insulation Resistance

From the Setup Tests Selection screen, press the “Add” soft key. The test types soft keys will now be displayed. From the Setup Tests, Tests Selection screen, press the “Insulation Resistance” soft key. The Insulation Resistance Parameter Setting screen will now be displayed. The Insulation Resistance Parameter Setting screen will appear as follows:

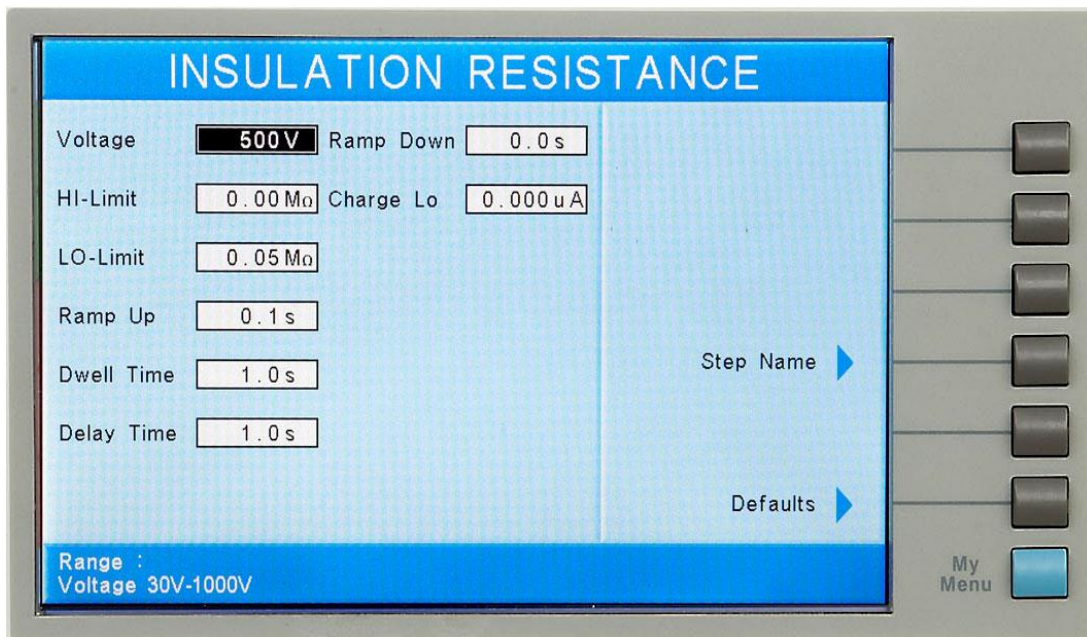

From the Insulation Resistance Parameter Setting screen the following parameters may be controlled: Voltage, HI-Limit, LO- Limit, Ramp Up, Dwell Time, Delay Time, Ramp Down, Charge-LO, Scanner Channel, Select Name and Defaults.

Charge-LO

The Charge-LO function is used to check if the cables are connected properly at the beginning of a test. A capacitive DUT will draw charging current on the DC Withstand Voltage test when the Output is activated. If the charging current is lower than the setting, the test cables may not be connected properly.

The instrument can set the Charge-LO parameter manually or automatically. To manually set the Charge-LO current, use the up and down arrow keys or the ENTER key and scroll the highlighted area to the Charge-LO current parameter. Enter the

new Charge-LO current via the numeric keypad and then press the ENTER key to accept the new parameter or press the EXIT key to escape from the edit.

To automatically set the Charge-LO current, use the up and down arrow keys or the ENTER key and scroll the highlighted area to the Charge-LO current parameter. Make sure that the voltage and ramp times are set to the values that will be used on the DUT and connect the test cables or test fixture between the instrument and DUT. Press the test button.

WARNING

Please be aware that the program will activate high voltage on the output connector when the Test button is pressed.

The program will read the charging current of DUT and set the Charge-LO current at approximately one half (1/2) of the reading. The highlighted parameter field will briefly show the word “READING” and then the display the new value. The new value is automatically updated in the field and does not allow an escape to the original value or that the ENTER key be used to accept the new parameter.

4.5.4. Continuity and Ground Bond

The Continuity test is generally used to test the ground conductor of a line cord. If the resistance exceeds the HI-Limit trip point or drops below the LO-Limit trip point the OMNIA II will signal a continuity failure.

- **NOTE:** When testing products with two pronged plugs do not activate the continuity circuit.

When the Ground Bond test is selected on the OMNIA, the High Current will be applied through the Current lead and flow back through the Return lead. The resistance is measured and compared to the HI and LO-Limit trip points stored in memory.

4.5.5. AC Ground Bond

From the Setup Tests Selection screen, press the “Add” soft key. The test types soft keys will now be displayed. From the Setup Tests Selection screen, press the “AC Ground Bond” soft key. The Ground Bond Parameter Setting screen will now be displayed. The Ground Bond Parameter Setting screen will appear as follows:

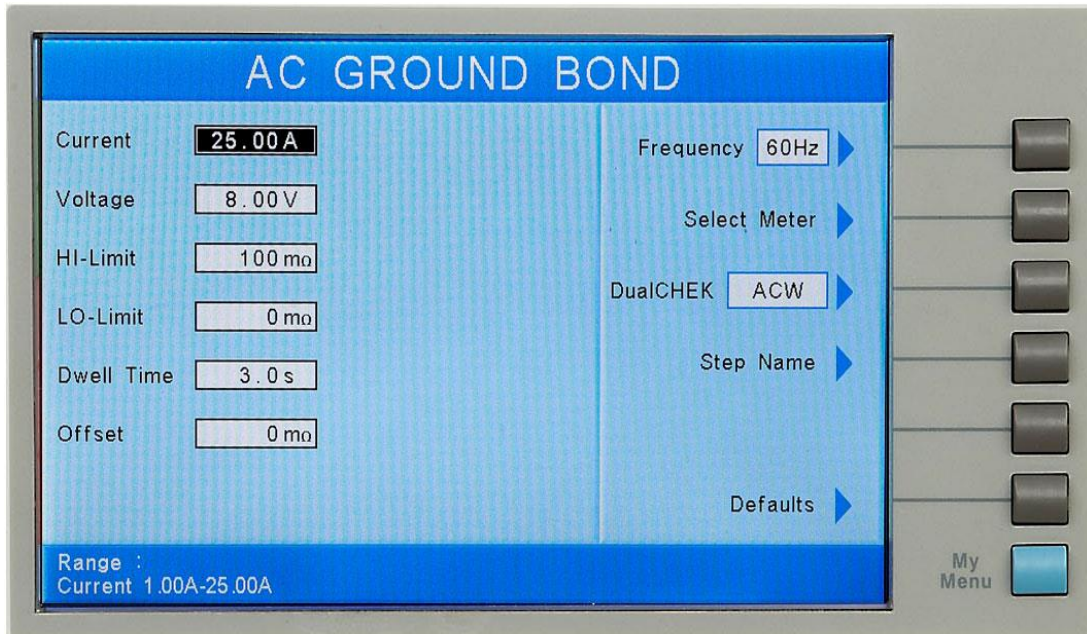

From the Ground Bond Parameter Setting screen, the following parameters may be controlled: Current, Voltage, HI-Limit, LO- Limit, Dwell Time, Offset, Scanner Channel, Frequency, DualCHEK, Step Name and Defaults.

Offset

This function allows the instrument to compensate for lead and test fixture resistance during a Ground Bond or Continuity test. Using the up and down arrow keys or the ENTER key, scroll the highlighted area to the Offset parameter. You may now manually or automatically set an Offset value.

To manually set an Offset value enter a milliohm value via the numeric keypad and then press the ENTER key to accept the new value or press the EXIT key to escape from the edit.

To automatically set an Offset value set the output voltage, current, and frequency to the values that will be used on the DUT and connect the test cables, test fixture, or Scanner channel to the instrument. Next, short the ends of the test cables and press the TEST button. The highlighted parameter field will briefly show the word "READING" and then display the new value. The new value is automatically updated in the field and does not allow an escape to the original value or require that the ENTER key be used to accept the new parameter.

DualCHEK

This function allows the instrument to simultaneously run a hipot and AC Ground Bond test. While pressing the "DualCHEK" soft key, the DualCHEK pop up screen will appear as follows:

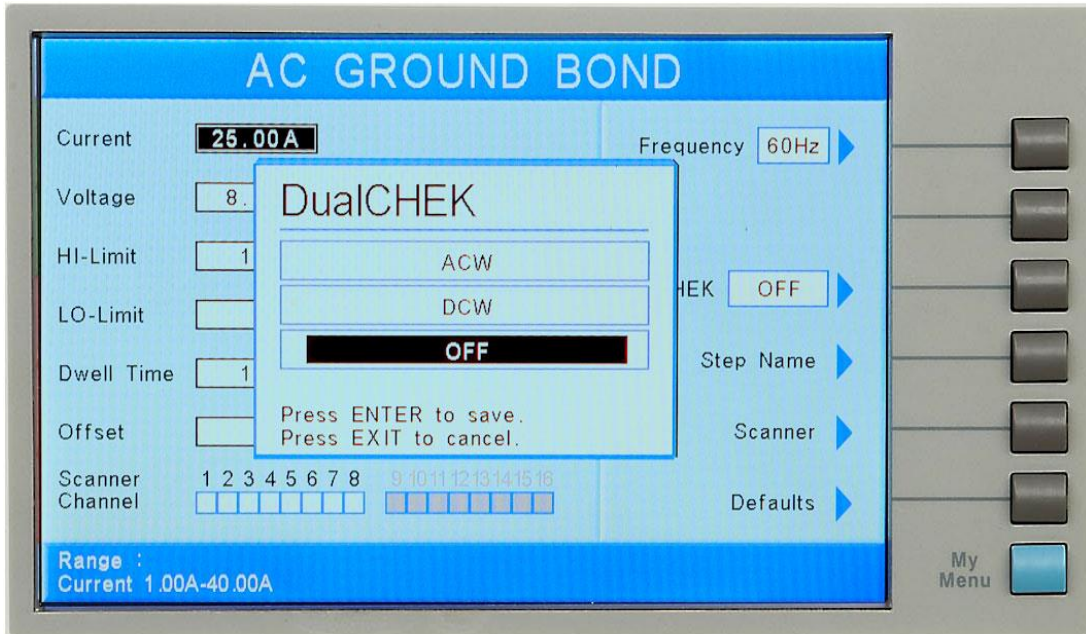

Use the up or down arrow keys to select the DualCHEK setting for this test. The DualCHECK setting options are ACW, DCW or OFF.

Once a parameter is edited, it is necessary to complete the edit either by pressing the ENTER key to accept the new value or the EXIT key to escape from the edit and return to the original value.

For the DualCHEK to function properly, the test immediately following the AC Ground Bond test in the sequence must be the test specified in the DualCHEK parameter. For example, if DualCHEK is set to ACW, the next test in the sequence after the AC Ground Bond test must be an ACW test. If the test immediately following the AC Ground test does not match the DualCHEK setting, the AC Ground Bond test and following test will run sequentially.

4.5.6. DC Continuity

From the Setup Tests Selection screen, press the “Add” soft key. The test types soft keys will now be displayed. From the Setup Tests Selection screen, press the “DC Continuity” soft key. The DC Continuity Parameter Setting screen will now be displayed. The DC Continuity Parameter Setting screen will appear as follows:

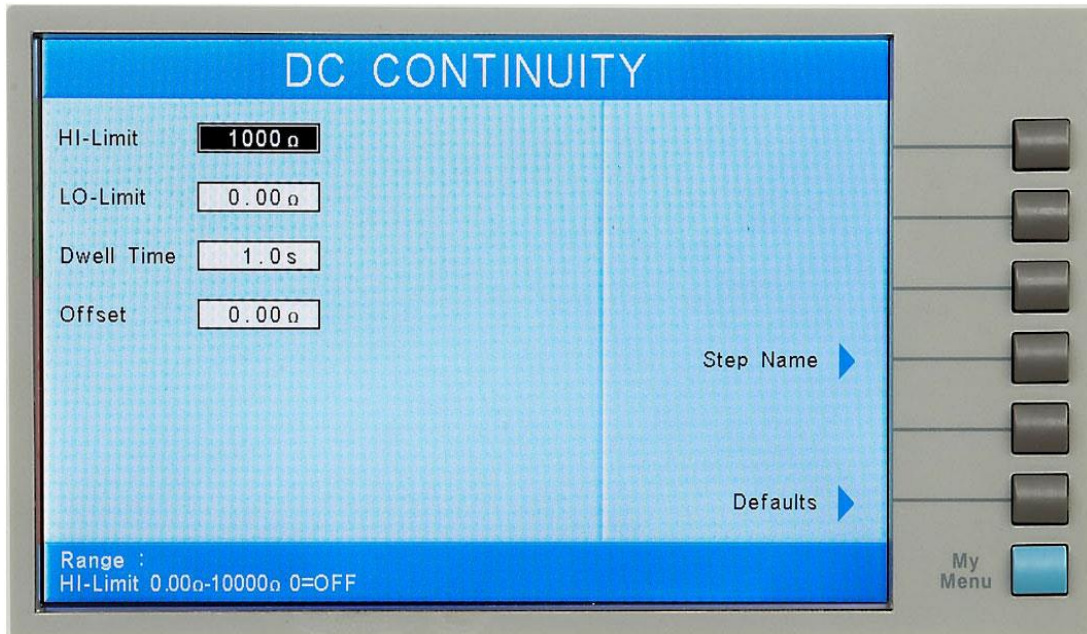

From the Continuity Parameter Setting screen, the following parameters may be controlled: HI-Limit, LO- Limit, Dwell Time, Offset, Scanner Channel, Step Name and Defaults.

Offset

This function allows the instrument to compensate for lead and test fixture resistance during a Ground Bond or Continuity test. Using the up and down arrow keys or the ENTER key, scroll the highlighted area to the Offset parameter. You may now manually or automatically set an Offset value.

To manually set an Offset value enter a milliohm value via the numeric keypad and then press the ENTER key to accept the new value or press the EXIT key to escape from the edit.

To automatically set an Offset value set the output voltage, current, and frequency to the values that will be used on the DUT and connect the test cables, test fixture, or Scanner channel to the instrument. Next, short the ends of the test cables and press the TEST button. The highlighted parameter field will briefly show the word "READING" and then display the new value. The new value is automatically updated in the field and does not allow an escape to the original value or require that the ENTER key be used to accept the new parameter.

4.5.7. Functional Run Test (Models 82x6 and 82x7)

Associated Research recommends performing a Hipot test with the Fail Stop ON prior to performing a Run Test or Leakage Current test. Performing a Hipot test first can detect if a DUT is shorted line to ground before applying line power to it.

From the Setup Tests, Tests Selection screen, press the "Run Test" soft key. The Run Test Parameter Setting screen will now be displayed. The Run Test Parameter

Setting screen will appear as follows:

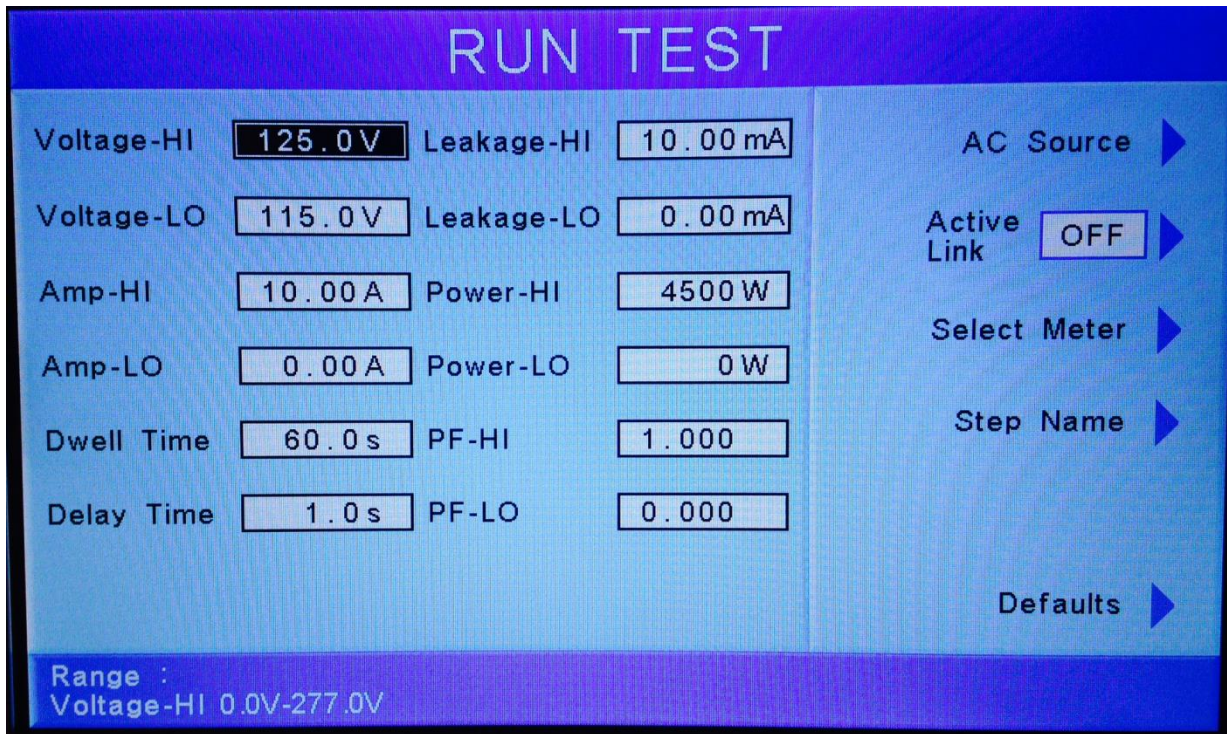

From the Run Test Parameter Setting screen, the following parameters may be controlled: Voltage-HI, Voltage-LO, Amp-HI, Amp-LO, Dwell Time, Delay Time, Leakage-HI, Leakage-LO, Power-HI, Power-LO, PF-HI and PF-LO, AC Source, Active Link, Select Meter and Step Name.

PF (Power factor)

Power Factor = W/VA where W =Watts (Real Power) and VA =Volts x Amps (apparent power). It is important to note that the closer the power factor is to "1" the more resistive the DUT is. The closer the power factor is to 0 the more reactive (inductive or capacitive) the DUT is.

Leakage (Leakage-HI and Leakage-LO)

Leakage in the Run Test mode refers to the amount of current which flows from the enclosure (case) of the DUT to the neutral side of the line input. The Leakage-HI trip limit is used to program the maximum allowable earth leakage current of the DUT before failure. The Leakage-LO trip limit is used to program the minimum allowable earth leakage current of the DUT before failure. The Leakage-HI trip limit also controls the earth leakage configuration as shown below:

Leakage HI & LO

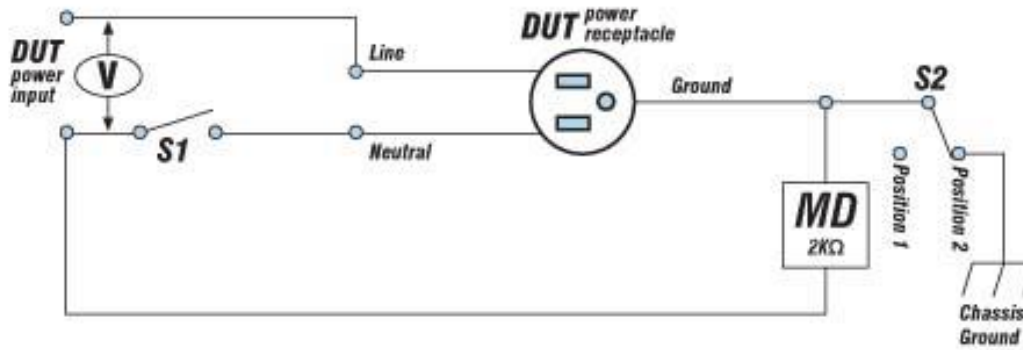

When the Leakage-HI trip limit is set to 0, S2 is placed in position 2 which disables the earth leakage test and connects the neutral of the DUT input to the ground of the DUT.

AC Source

Press the “AC Source” soft key to enter the AC Source Test Parameter screen. The screen will look as follows:

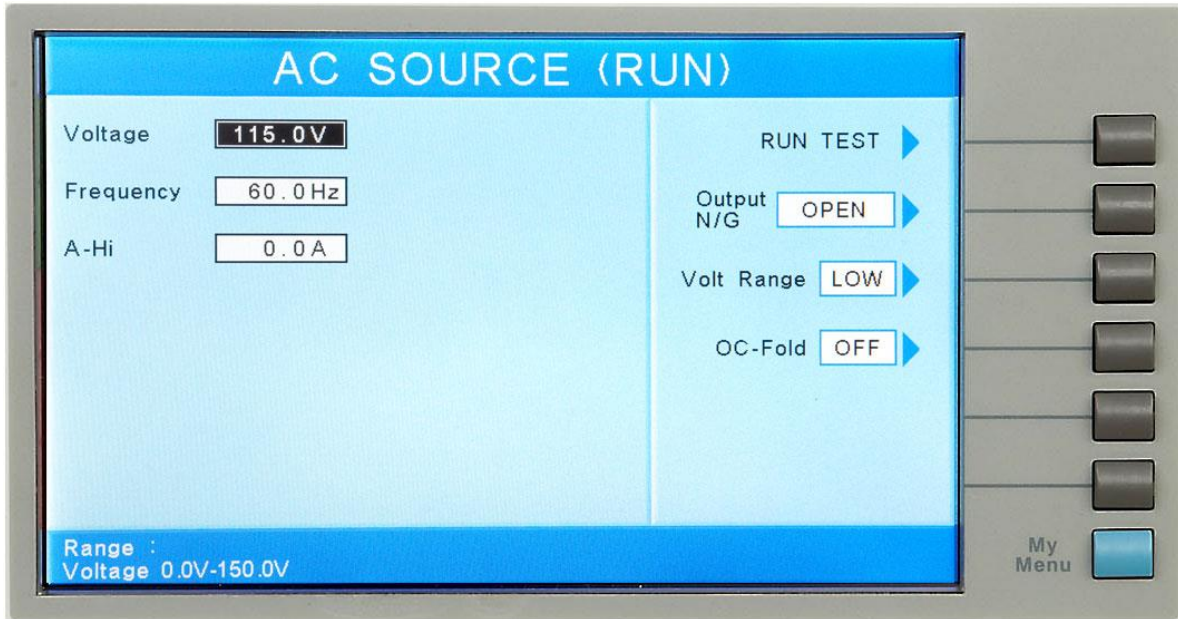

From this screen, you can control the following test parameters: Voltage, Frequency, A-Hi, Output N/G, Volt Range and OC-Fold. The A-Hi parameter allows you to set the AC Source high current limit. The Output N/G parameter allows you to configure the AC Source output to either open or close the ground connection. The Volt Range parameter controls the output range of the AC Source (high or low). See specifications for more details. The OC-Fold parameter allows you to set the output of the AC source in constant current mode. When active, the A-Hi parameter can be used to set the output current of the AC source.

4.5.8. Leakage Current test (Models 82x6 and 82x7)

Associated Research recommends performing a Hipot test with the Fail Stop ON prior to performing a Run Test or Leakage Current test. Performing a Hipot test first can detect if a DUT is shorted line to ground before applying line power to it.

From the Setup Tests, Tests Selection screen, press the “Leakage Current ” soft key. The Leakage Current parameter setting screen will now be displayed. The Leakage Current Parameter Setting screen will appear as follows:

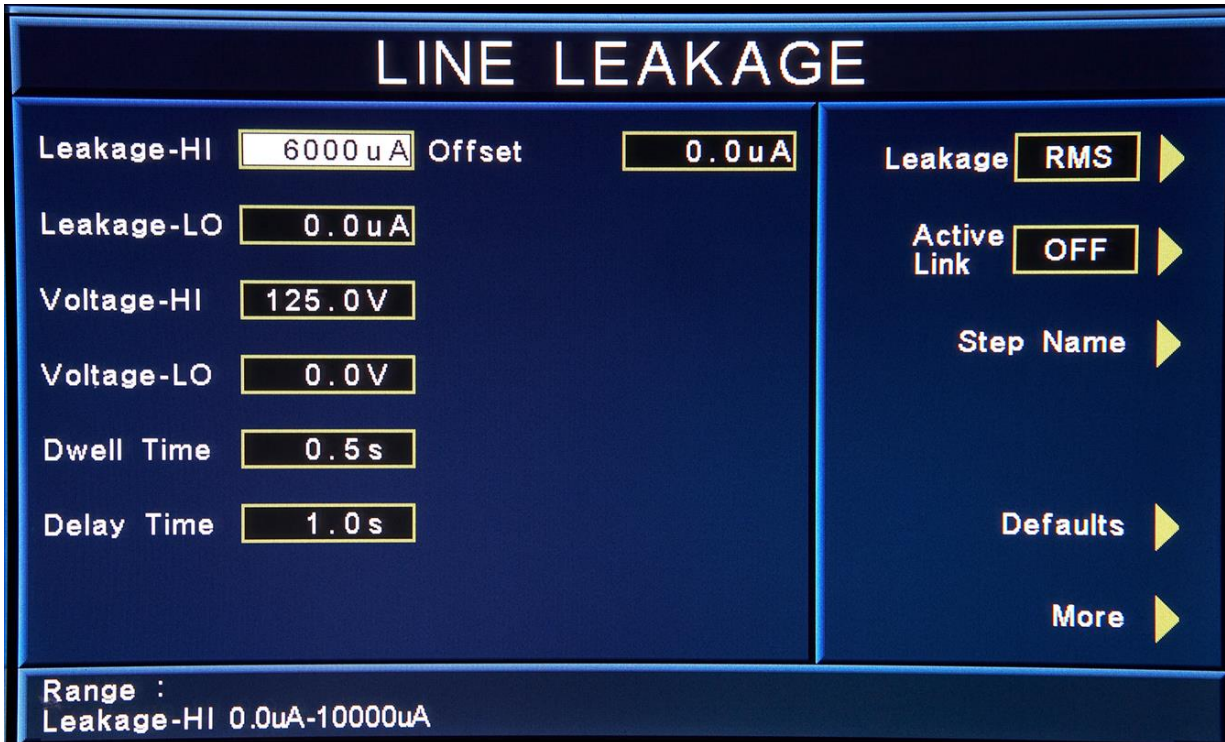

From the Leakage Current Parameter setting screen, the following parameters may be controlled: Leakage-HI, Leakage-LO, Voltage-HI, Voltage-LO, Dwell Time, Delay Time, Offset, Leakage, Active Link, Step Name, Scanner Channel, Defaults and More. Pressing the More key will bring up additional parameters: Reverse, Neutral, Ground, Measuring Device and Probe. Pressing the More soft key again will bring up additional parameters: AC Source, AC/DC, Select Meter, and Ranging Mode.

Leakage-HI: The maximum leakage current allowable through the measuring device that triggers a failure when exceeded.

Leakage-LO: The minimum leakage current allowable through the measuring device that triggers a failure when not exceeded.

Offset: The offset of leakage current measurements taken during a line current test. The purpose of the LLT Offset is to allow the unit to zero out leakage current associated with instrument, the instrument leads and any other integrated Associated Research, Inc. instruments. Since there is a capacitive value associated with the Associated Research Inc. instruments, leakage current due to this capacitance factors into the total leakage value displayed during a line current test.

The Omnia II applies a formula for taking an offset into account:

$$\text{Displayed Current} = \sqrt{(\text{Total Leakage Current})^2 - (\text{Offset Current})^2}$$

The “Total Leakage Current” is the measure of the total leakage current on the system including the Omnia II, other integrated Associated Research, Inc. instruments and the

device under test. The “Offset Current” is the offset current value either specified by the user or calculated automatically by the Omnia II unit. These two values are used to calculate the actual displayed leakage current measurement. The instrument then calculates the vector sum of the offset value and the total value so that the inherent leakage of the Associated Research, Inc. instruments is excluded from the measurements.

Line Configuration Soft keys

The LINE configuration is determined by the relays S1, S2 and S3 (see Figure below) and is set using the corresponding Line Configuration Soft keys. The S1 relay is represented as NEUTRAL and is controlled by the Neutral soft key. The S2 relay is represented as REVERSE and is controlled by the Reverse soft key. The S3 relay is represented as GROUND and is controlled by the Ground soft key. Pressing the relay’s corresponding soft key will toggle it between its two available states.

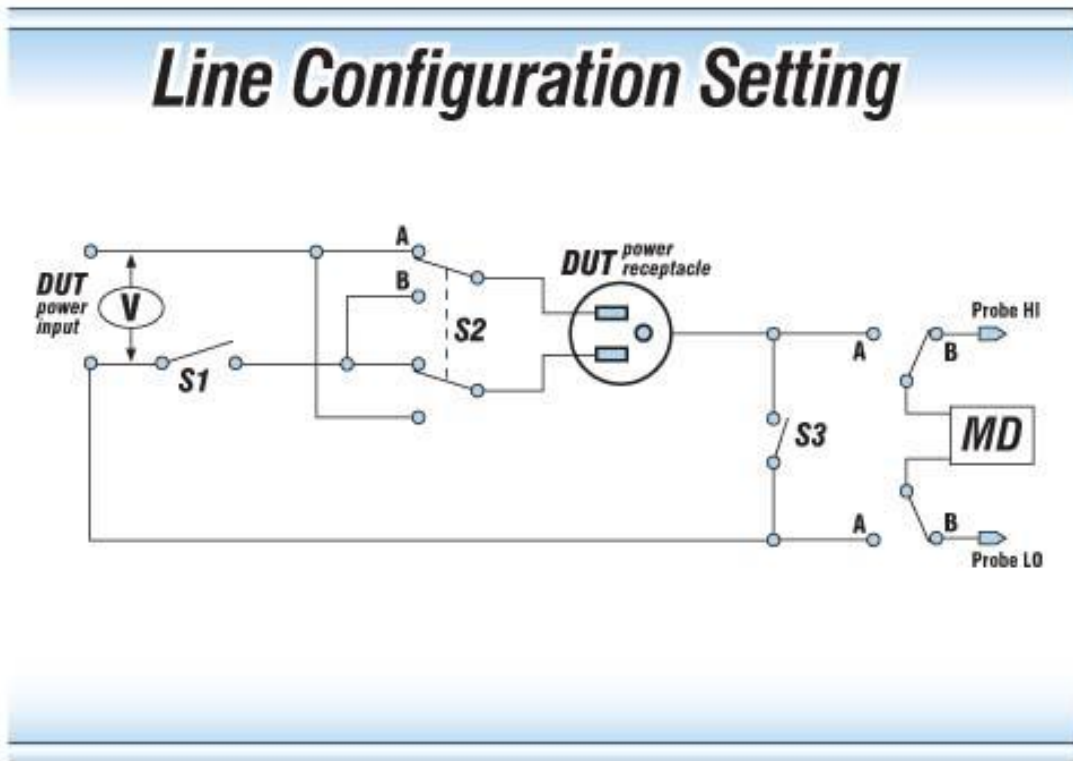

Line Configuration Setting

When the Neutral or Ground relays are set to the CLOSED position they are in a normal operating condition. When the Neutral or Ground relays are set to the OPEN position they are in a fault condition that represents a fault in the line input wiring.

When the REVERSE relay is set to ON the relay is in position B (refer to Figure above) and the Line and Neutral conductors are reversed at the DUT power outputs. The power output is represented as the power receptacle in Figure 2.

The three relays may be configured into eight different combinations of Line

conditions. The different combinations are represented in the table below.

LINE CONFIG.	NEUTRAL		REVERSE			GROUND	
	Relay/ Soft key	Fault	Soft key	Relay	Fault	Relay/ Soft key	Fault
1	Open	Yes	OFF	A	No	Open	Yes
2	Open	Yes	ON	B	Yes	Open	Yes
3	Open	Yes	OFF	A	No	Closed	No
4	Open	Yes	ON	B	Yes	Closed	No
5	Closed	No	OFF	A	No	Open	Yes
6	Closed	No	ON	B	Yes	Open	Yes
7	Closed	No	OFF	A	No	Closed	No
8	Closed	No	ON	B	Yes	Closed	No

Probe Configuration

The Probe configuration is controlled by the relays SH and SL shown in Figure 2 and are set by the “Probe” soft key. These two relays configure the current measuring device into three possible positions. Repeatedly pressing the Probe soft key allows the selection of the three different states. The three positions are described in the table below.

MEASURING DEVICE POSITION	SH	SL	DISPLAY INDICATION	AGENCY TEST APPLICATION
Ground to Line	A	A	Ground to Line	Protective Conductor Current
Probe HI to Line	B	A	Probe-HI to Line	Touch Current
Probe-HI to Probe-LO	B	B	Probe-HI to Probe-LO	External Applied Part or Point to point Leakage

A diagram of the probe configurations is shown in the image below.

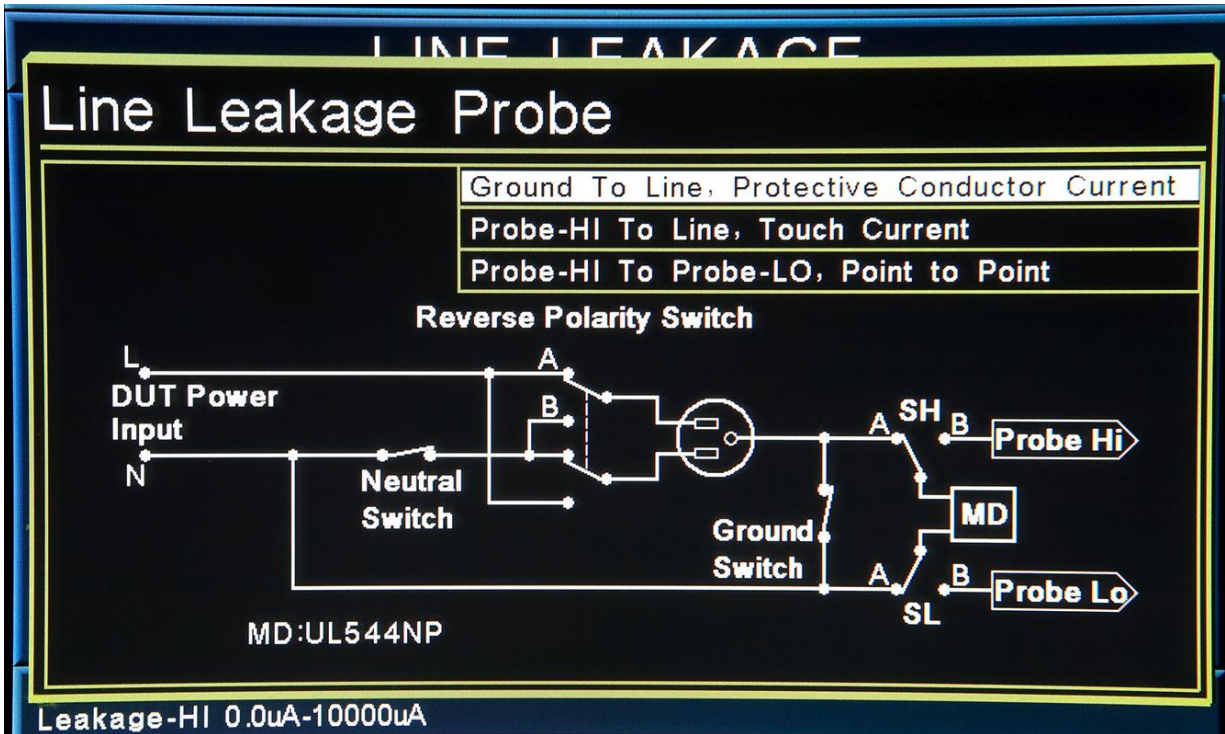

Ground-to-Line indicates the MD is connected to measure the leakage current in the line cord from the earth ground conductor back to the system neutral. This is referred to as an PROTECTIVE CONDUCTOR CURRENT TEST.

Probe-HI to Line indicates the MD is connected between the PROBE HI terminal on the instrument, which should be connected to the ENCLOSURE of the DUT, and the system neutral. This is known as an TOUCH CURRENT TEST.

Probe-HI to Probe-LO indicates the MD is connected between the PROBE HI and the PROBE LO terminals on the instrument which allow the operator to connect the MD between applied parts.

Measuring Device

The Measuring Device is an impedance circuit that simulates the human body. The Measuring Device is specified differently for different applications and specifications. Repeatedly pressing the “Measure Device” soft key will allow you to select one of the many measuring devices listed in the table below. The table below indicates the available measuring devices and the appropriate agency standard to which it correlates.

Cross Reference Number	Agency Specification	Application
1	UL544 Non patient equipment	Medical Equipment
2	UL544 Patient care equipment	Medical Equipment
3	IEC601-1, UL2601, EN60601-1	Medical Equipment
4	UL1563	Electric Spas, Equipment Assemblies and Associated Equipment
5	IEC60990 Fig4-U1, IEC60950	Laboratory Equipment Information Technology
6	IEC60990 Fig4-U2, IEC60950	Laboratory Equipment Information Technology
7	IEC60990 Fig5-U3	Laboratory Equipment Information Technology
External	User configurable	User configurable
Frequency Check	The Leakage Current test can be configured to verify the bandwidth of the leakage current “voltmeter”, by setting the Probe configuration, “Probe-HI to Probe-LO”, and selecting the measuring device “Frequency Check”.	The selection is intended to be used for meter verification only and has no application for normal testing.

Measuring Device Diagrams

Diagrams of the measuring devices are shown in the images below.

LINE LEAKAGE

Measure Device

Input Hi A

1.5KΩ

0.15μF

Input Lo B

UL544NP
UL544P
IEC60601 UL2601
UL1563
IEC60990 Fig4-U2 IEC60950
IEC60990 Fig5-U3
External
Frequency Check

Leakage-HI 0.0uA-10000uA

My Menu

LINE LEAKAGE

Measure Device

Input Hi A

1KΩ

0.15μF

10.2Ω

Input Lo B

UL544NP
UL544P
IEC60601 UL2601
UL1563
IEC60990 Fig4-U2 IEC60950
IEC60990 Fig5-U3
External
Frequency Check

Leakage-HI 0.0uA-10000uA

My Menu

LINE LEAKAGE

Measure Device

UL544NP
UL544P
IEC60601 UL2601
UL1563
IEC60990 Fig4-U2 IEC60950
IEC60990 Fig5-U3
External
Frequency Check

Leakage-HI 0.0uA-10000uA

My Menu

LINE LEAKAGE

Measure Device

UL544NP
UL544P
IEC60601 UL2601
UL1563
IEC60990 Fig4-U2 IEC60950
IEC60990 Fig5-U3
External
Frequency Check

Leakage-HI 0.0uA-10000uA

My Menu

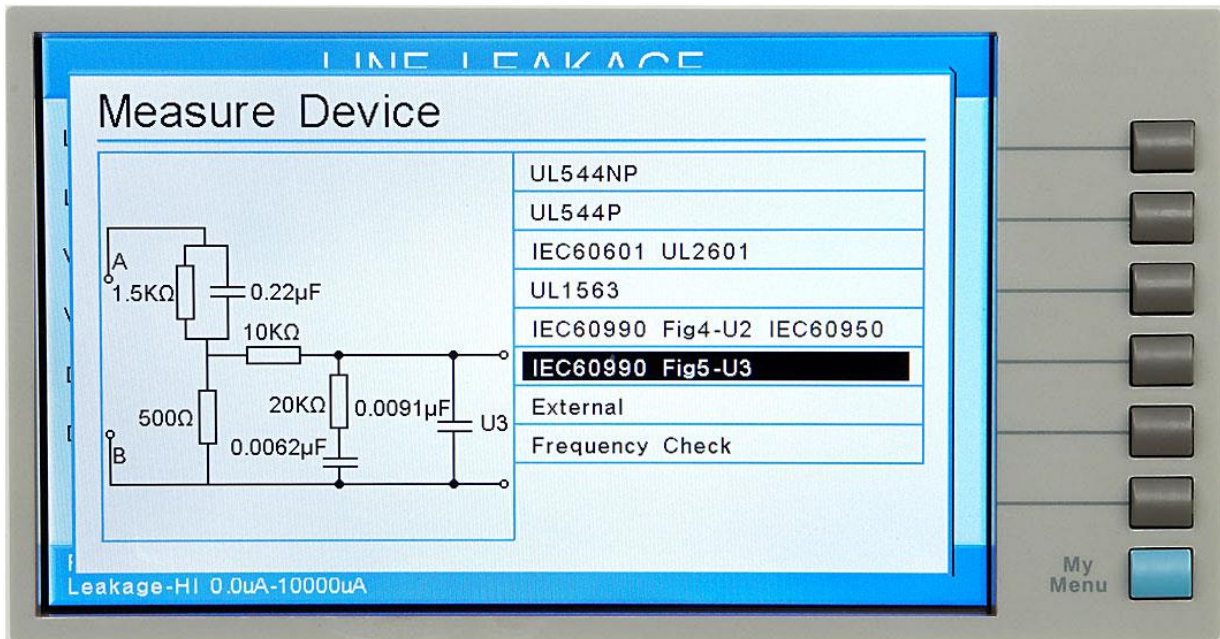
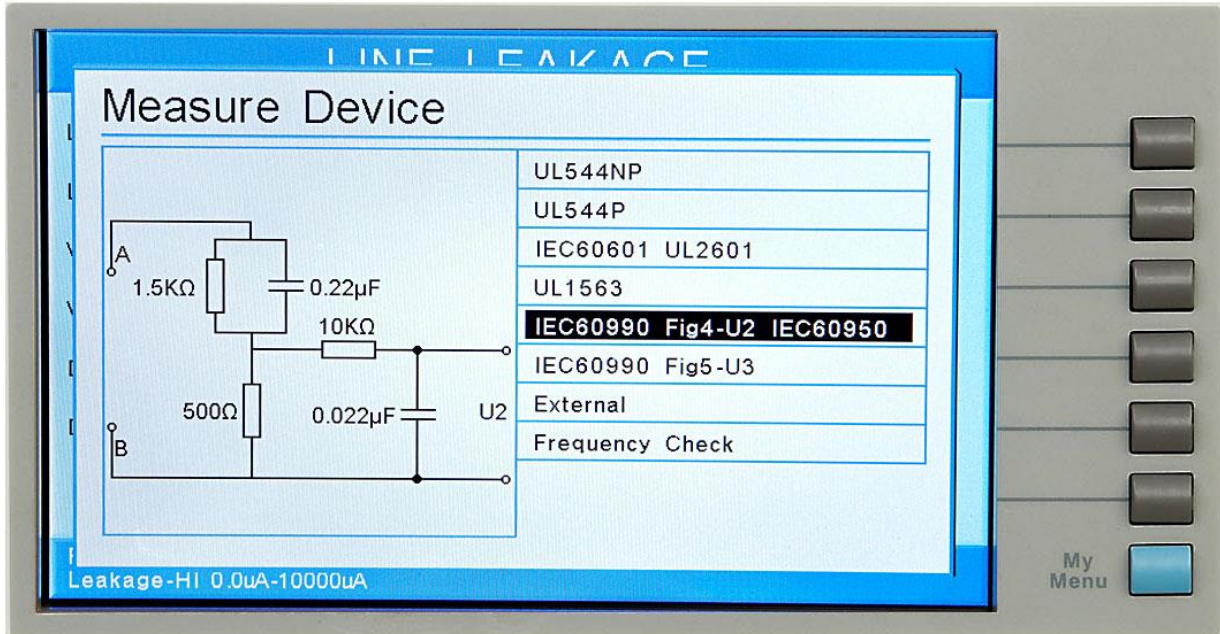

External Measuring Device

The OMNIA 8206 and 8207 have an access panel on the back of the instrument that can be removed to access the MD external PCB. The MD external PCB may be configured for a simple resistive measuring device. No components are supplied for the population of the PCB.

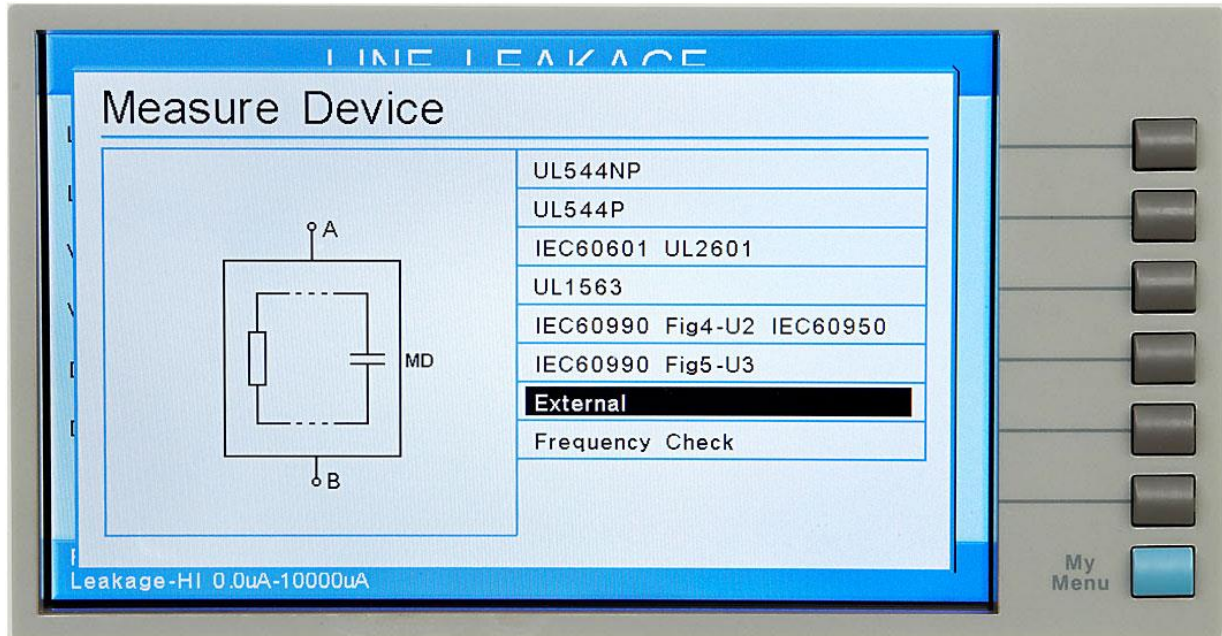

Frequency Check

The Leakage Current test can be configured to verify the bandwidth of the leakage current “voltmeter” by setting the Probe configuration to “Probe-HI to Probe-LO” and selecting the medical device “Frequency Check”. The selection is intended for meter verification purposes only and has no application for normal testing.

The calculation of the displayed leakage current will use 1000Ω for R in the calculation of $V/R=I$ where I is the leakage current displayed and V is voltage across the measuring device (MD). When an external frequency generator is applied to the probe inputs, the current display will be equal to Voltage generator/1000. The readings can then be correlated to verify the voltmeter bandwidth.

Since the voltage is being applied directly across the MD voltmeter amplifier inputs, it is not necessary to actually install a $1K\Omega$ resistor to the external MD input. It is necessary to have the 0Ω resistors installed in position R1 and R3 on the external measuring device PCB to operate in this mode. If the external Measuring Device has been populated in a different configuration, it will be necessary to create a temporary short on R1 and R3 to operate in this mode. Another option would be to acquire a spare external measuring device PCB for the meter verification purpose.

AC Source

Press the “AC Source” soft key to enter the AC Source Test Parameter screen. The screen will look as follows:

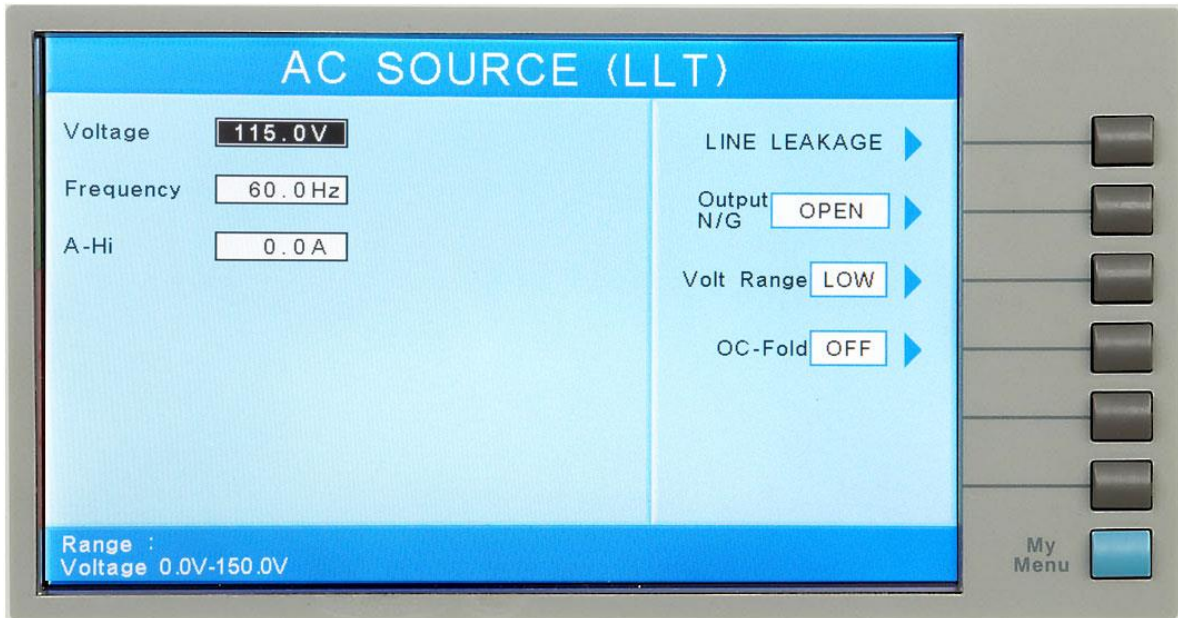

From this screen, you can control the following test parameters: Voltage, Frequency, A-Hi, Output N/G, Volt Range and OC-Fold. The A-Hi parameter allows you to set the AC Source high current limit. The Output N/G parameter allows you to configure the AC Source output to either open or close the ground connection. The Volt Range parameter controls the output range of the AC Source (high or low). See specifications for more details. The OC-Fold parameter allows you to set the output of the AC source in constant current mode. When active, the A-Hi parameter can be used to set the output current of the AC source.

4.6. My Menu

From the System Setup screen press the “My Menu” soft key. The My Menu screen appears as follows:



The My Menu function allows the user to configure a custom menu. In order to customize a softkey selection, press and hold one of the softkeys until the My Menu pop appears as follows:

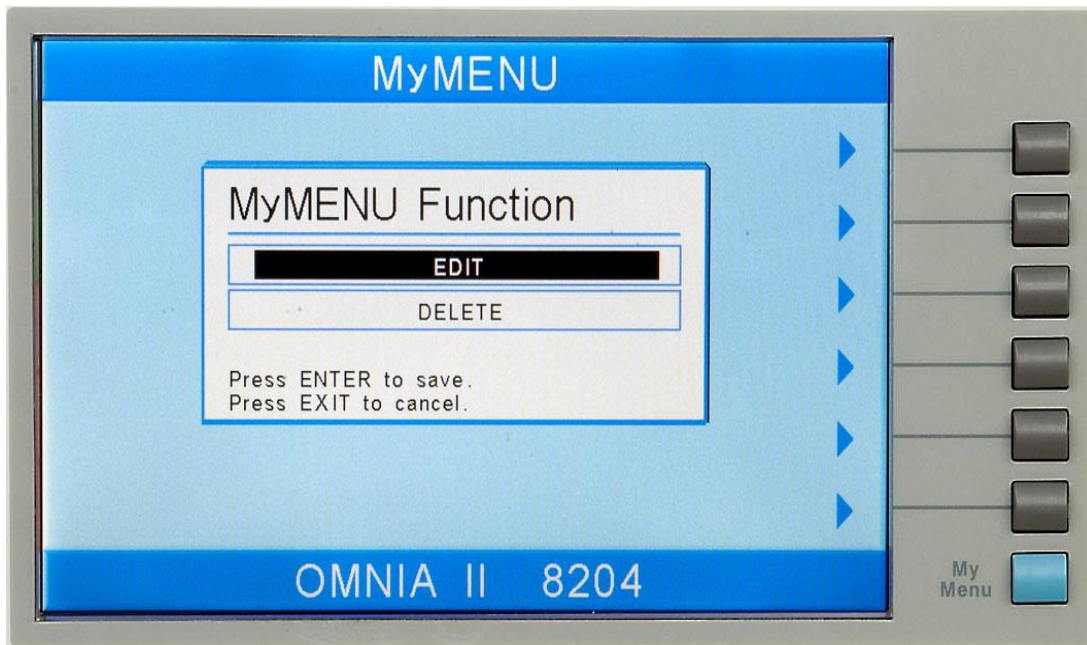

Use the up or down arrow keys to select the preferred function. The My Menu setting options are EDIT and DELETE. EDIT will allow the user to select a system, test or file

parameter. DELETE will clear the current softkey selection.

Once a parameter is edited, it is necessary to complete the edit either by pressing the ENTER key to accept the new value or the EXIT key to escape from the edit and return to the original value.

When selecting EDIT, the user will be directed to the main MENU screen. All softkey selections highlighted in red can now be added as a My Menu softkey selection. To add a selection as a My Menu softkey, press and hold the desired softkey until the My Menu Function pop up appears as follows:

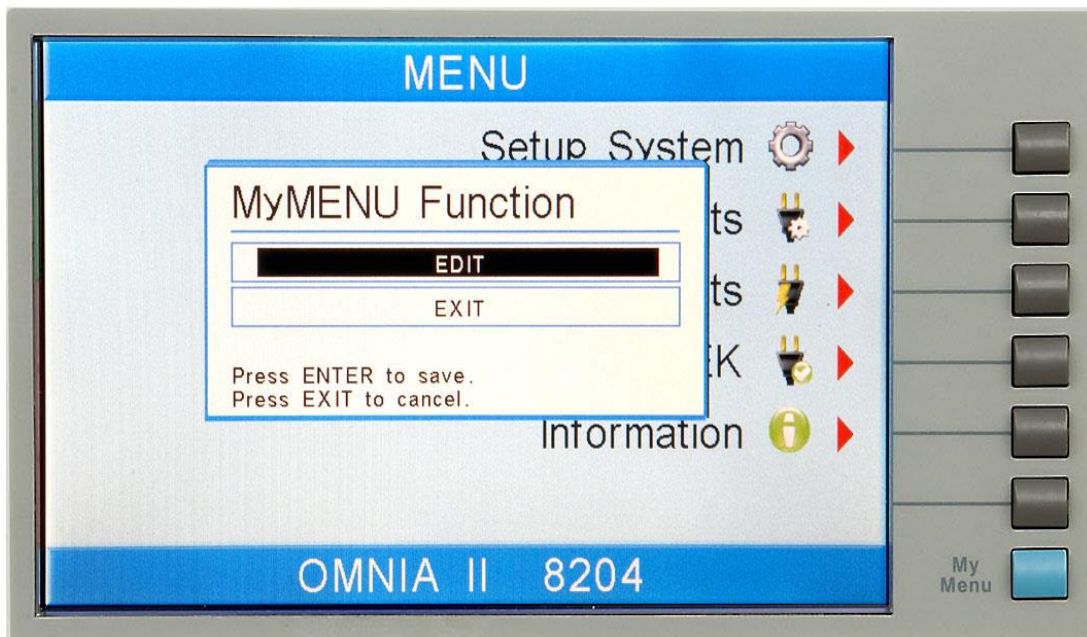

Use the up or down arrow keys to select the preferred function. The My Menu setting options are EDIT and DELETE. Selecting EDIT will input the selected parameter as a My Menu soft key. DELETE will clear the current soft key selection.

Once a parameter is edited, it is necessary to complete the edit either by pressing the ENTER key to accept the new value or the EXIT key to escape from the edit and return to the original value.

To navigate to other menus within the unit, simply press the soft key selection without holding it down.

5. OPERATING INSTRUCTIONS

5.1. Instrument Connections

The test leads and the adaptor box may be connected to the receptacles located on the front or the back of the OMNIA. The HV, Current, Return, Sense+, and Sense- and receptacles located on the front panel of the OMNIA are wired in parallel with another set located on the back of the instrument.

5.1.1. Connecting the Test Leads

The instrument comes with all cables necessary for performing a Hipot, Continuity, Ground Bond, and Insulation Resistance test. Connect the HV lead with the alligator clip and white insulating tip into the HV receptacle on the OMNIA. Connect the Return lead with the black alligator clip into the Return receptacle and the Sense- receptacle. Connect the Ground Bond lead with the red alligator clip into the Current and Sense+ receptacles.

5.1.2. Adapter Box Connections

The adapter box provides an easy way to connect a line-cord terminated DUT to the OMNIA. The following diagrams show how to connect the adapter box to the OMNIA 8204, 8206 and 8207 to the device under test.

Adapter Box Connections Model 8204

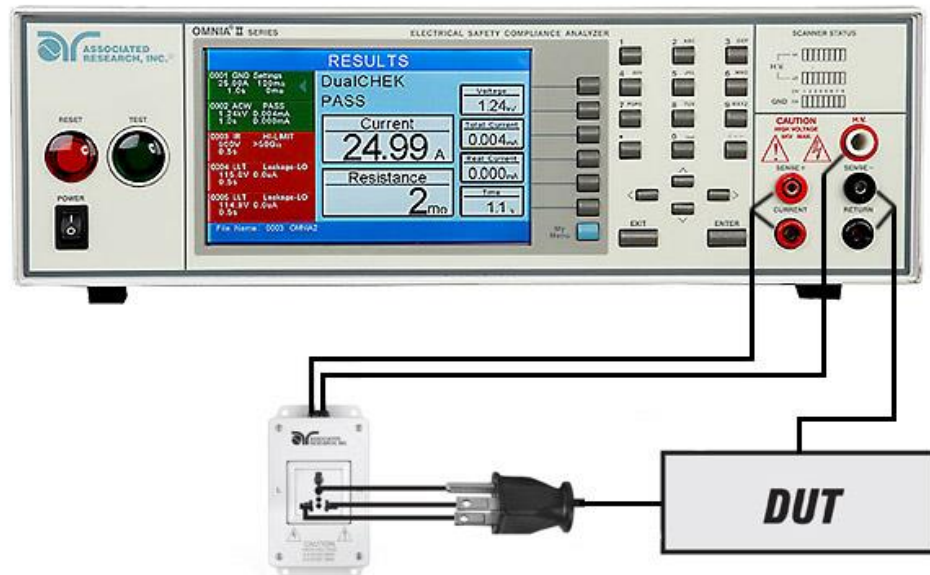

The rear output connections may be used for connecting the adapter box as well.

Adaptor Box Connections Model 82x6 and 82x7

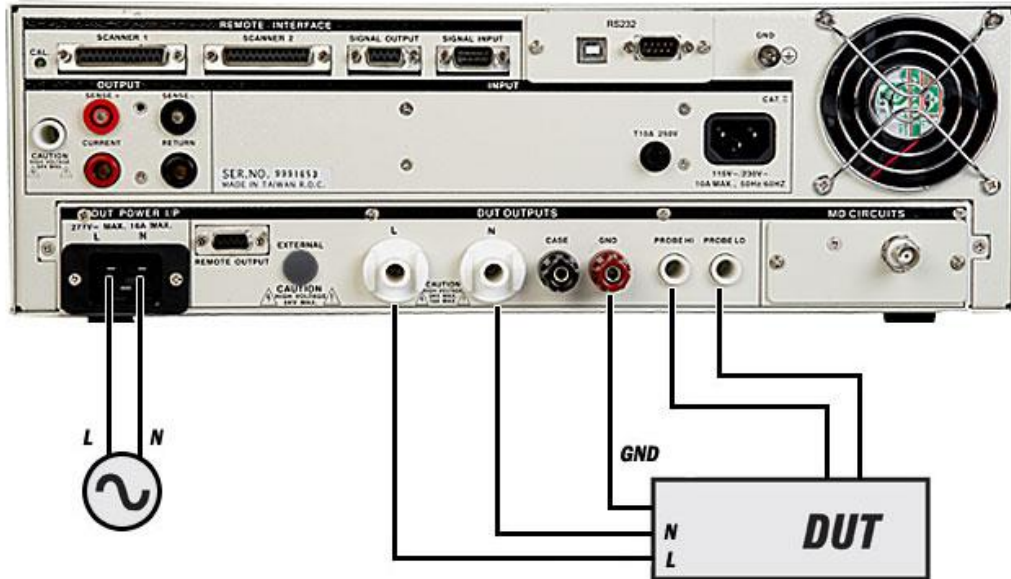

5.1.3. Interlock Connector

OMNIA is equipped with a Remote Interlock feature. Remote Interlock utilizes a set of closed contacts to enable the instrument's output. If the Remote Interlock contacts are open the output of the instrument will be disabled. Remote Interlock can also be referred to as a remote system lockout, utilizing "fail when open" logic. To disable the Remote Interlock feature connect the Interlock Key into the Signal Input port located on the back of the tester.



5.1.4. DUT Input Voltage Connections for Models 82x6 and 82x7

An unbalanced single-phase supply must be used with the OMNIA. This means that there is only one HOT or LINE conductor and the other conductor of the power source

must be at a low voltage reference potential. The low voltage reference does not need to be physically earth grounded but should not carry any large voltage potential.

The 220 - 240V US style line power **IS NOT** suitable to connect to the DUT inputs. This style of power distribution is a balanced type with two HOT or LINE conductors.

WARNING

Be sure that the hot lead of the power source is connected to pin 1, L (line) terminal of the DUT input connector and the return or low voltage lead is connected to pin 2, N (neutral) terminal of the DUT input connector. **DO NOT** connect a line conductor to the N or Neutral terminal of the DUT inputs. This condition can be very dangerous to the OMNIA user.

If voltage is applied to pin 2, N (neutral) terminal of the DUT input and you attempt to execute a Run Test or Leakage Current test, a warning message will appear in the displayed messages portion of the screen that says **Neutral-V**. If you see this message, you will need to correct the voltage problem before the instrument will allow you to execute Run Tests or Leakage Current tests.

5.1.5. Scanner Connections

WARNING

The Scanner provides 8 High Voltage channels and 8 Ground Bond channels on the rear panel. The High Voltage channels can be set to a High or Low level giving the capability to test from one channel to another channel or from any channel to a common Low or Return point. The channels can be connected in parallel if desired but there is only one leakage current measurement for all channels. The Ground Bond channels can test only from one channel to the common Return and only one channel may be used for each test.

Instructions for setting the Scanner channels are in the section **4.4. Test Parameters** of this manual.

The Scanner will provide output to multiple test points and will have the same operation specifications that apply to the standard instrument with the exception of one Ground Bond channel limitation. Due to the characteristics of general-purpose High Current relays, some additional contact resistance cannot be prevented. Although this contact resistance can be offset using the milliohm offset feature of the instrument, there will be some variation of the contact resistance because the relay must open and close. Each relay closure may represent a different resistance value. The Ground Bond channels will have the following characteristics:

Ground Bond/Continuity Channel Resistance Deviation	
Deviation (Relay Contact)	Test Current
6mΩ maximum	≥10A

5.2. Perform Tests Menu

From the Main Menu screen, press the soft key “Perform Tests”. The Perform Tests Menu will now be displayed. From the Perform Tests screen, four different software controls may be accessed: Single Step (ON/OFF), Fail Stop (ON/OFF), Load File, Results. The arrow keys may also be used to scroll the highlighted area to a specific test or page of tests if the file is larger than 10 steps. The Perform Tests screen will appear as follows:

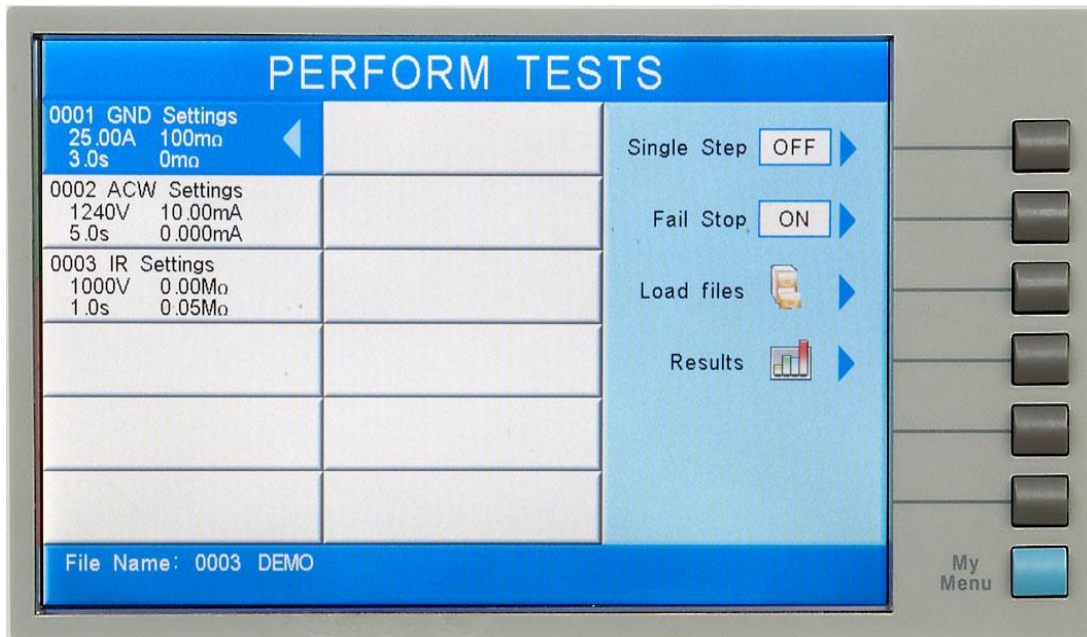

The Perform Tests screen is the main operational screen of instrument. From this screen individual steps are monitored while the test is being performed. At the end of a sequence of tests, all of the step results may be recalled via the “Results” soft key on this screen. This screen may also be used to debug test files with the use of the single step and fail stop functions.

5.2.1. Load File

From the Perform Tests screen, press the “Load File” soft key. The Load File screen will now be displayed. The Load File screen will appear as follows:

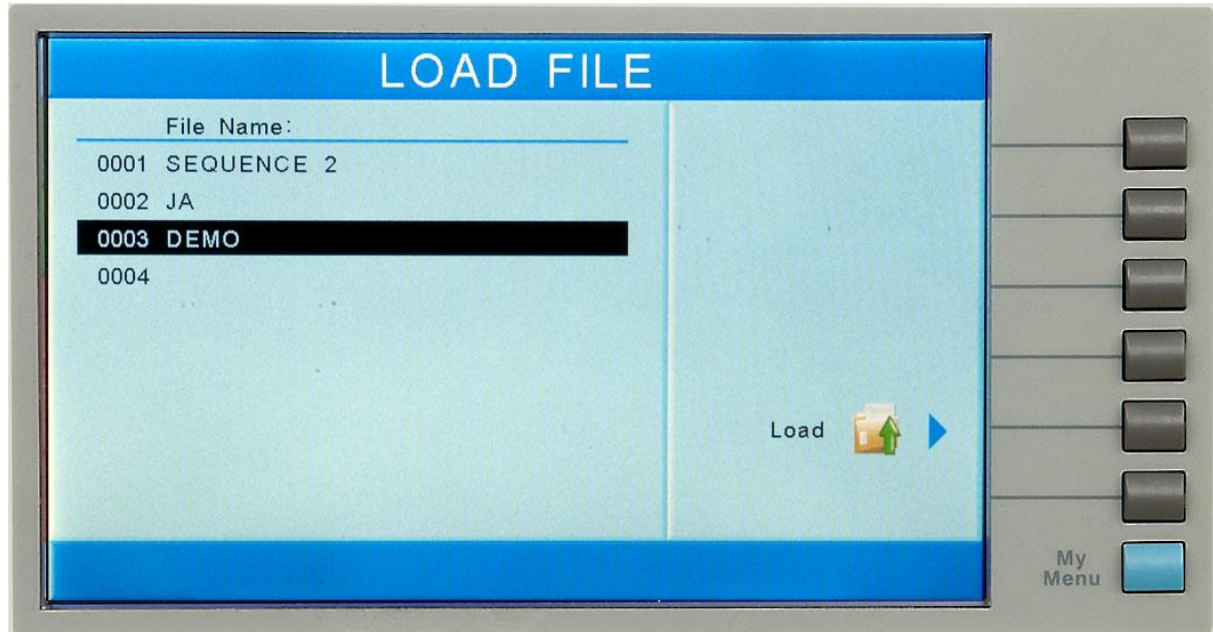

Using the up and down arrow keys, scroll the highlighted area to the File you would like to load and press the “Load” soft key. The file you selected will now load and the screen will revert to the Perform Tests screen.

5.2.2. Single Step

Single step is a function that allows you to run one step at a time from a sequence of tests. At the Perform Tests screen, use the up and down arrow keys or the ENTER key to scroll the highlighted area to the step you wish to perform. Press the TEST button and the instrument will initiate the single step and stop when finished without continuing to the next step.

You may single step through an entire sequence in this way as long as you do not press RESET. Once RESET is pressed it will return you to the originally selected step.

Turn the Single Step function ON and OFF by pressing the “Single Step” soft key. If Security is enabled, single step may not be turned ON and OFF at the Perform Test screen. The state Single Step is in at the time security is enabled is the state at which it shall remain.

5.2.3. Fail Stop

Fail Stop is a function that will stop a sequence of tests at the step that fails. If the Fail Stop is turned ON and a failure occurs (stopping the test), pressing the TEST button will start the test sequence at the original step. If Fail Stop is turned OFF, the sequence of tests will continue to the end of the sequence regardless of whether or not a failure has occurred. If the Fail stop is OFF and a failure occurs during the test sequence, the RESET button will light and a short alarm will sound but the sequence will continue to the end. At the end of the test sequence, the RESET button will light and alarm will sound indicating failure during the sequence. Pressing the RESET

button will silence the alarm and reset the instrument.

Turn the Fail Stop function ON and OFF by pressing the “Fail Stop” soft key. If security is enabled you may not turn Fail Stop ON and OFF using the “Fail Stop” soft key. Fail Stop automatically defaults to the setting stored in the file when security is activated.

Fail Stop with Run and Leakage Current tests

Associated Research recommends performing a Hipot test with the Fail Stop ON prior to performing a Run Test or Leakage Current test. Performing a Hipot test first can detect if a DUT is shorted line to ground before applying line power to it.

5.2.4. Results

At the end of a test sequence or single step test, you may review the measurements of each test by pressing the “Results” soft key. Results may be accessed from the end of test Summary screen or from the Perform Tests screen. The end of test Summary screen appears as follows:

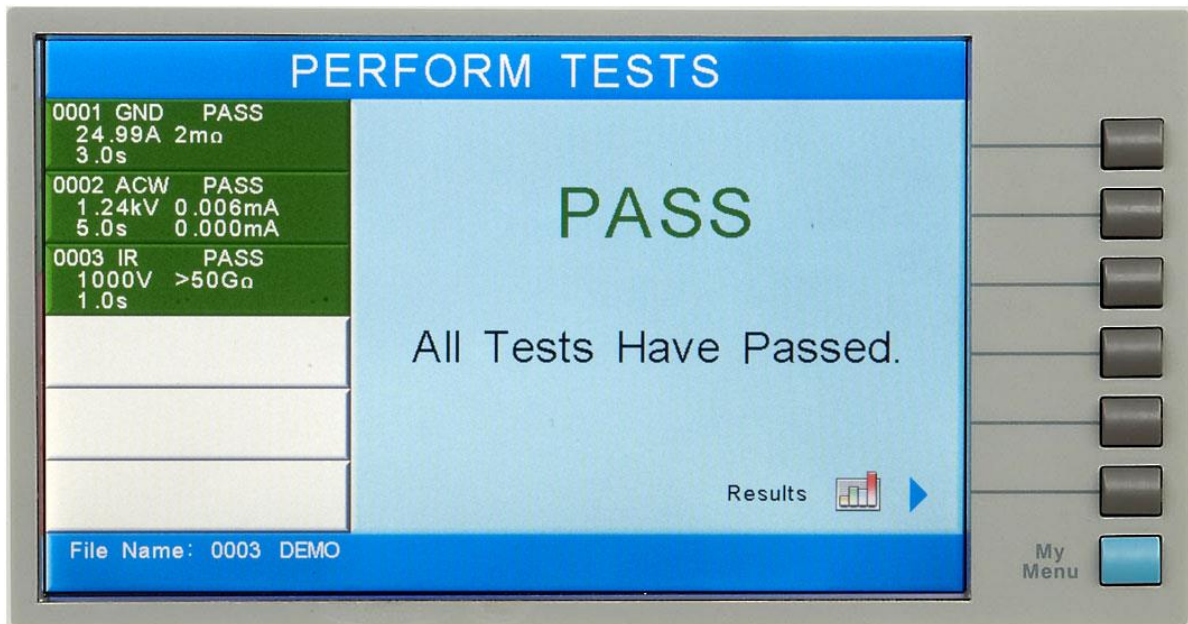

The Results screen will appear as follows:

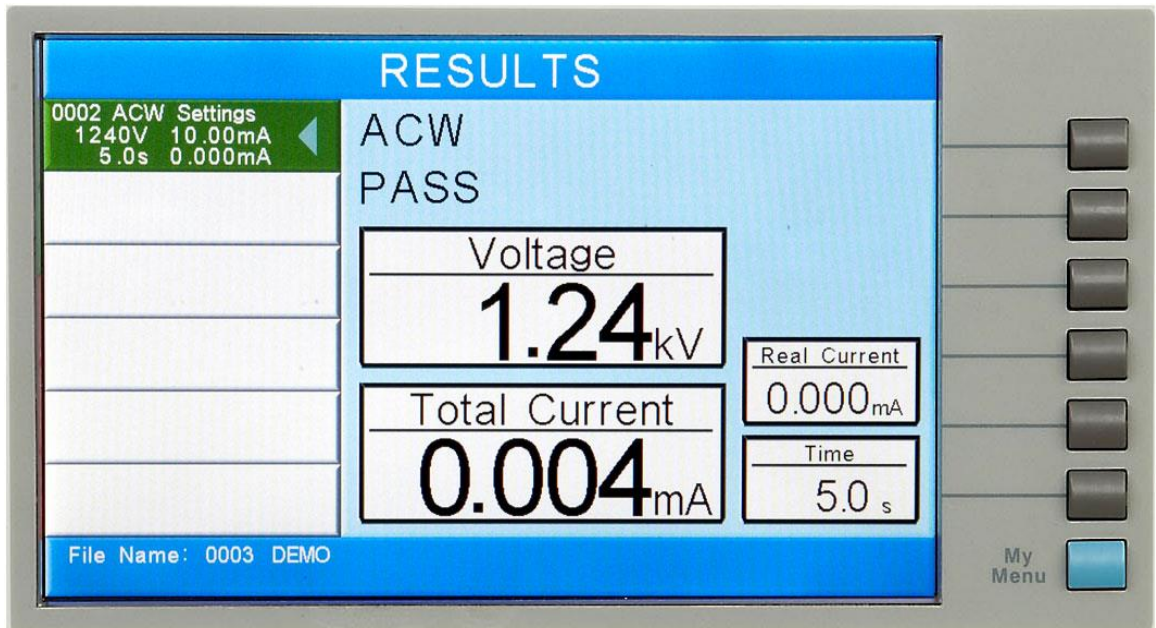

Using the up and down arrow keys, scroll the highlighted area to the step results you wish to review. The left and right arrow keys may be used to page through results if the test contains more than five steps. When the highlighted area is on the step you are reviewing, the test settings will be displayed in the highlighted area and the results will appear on the right in the form of metering screens. The result screens will appear differently for each type of test. The results screens are based on the Performing Tests metering screens and are identical in appearance except for the title. Refer to section **5.4. Perform Tests Metering** for the meters that will be displayed.

5.3. Performing a Test

1. As instructed in section **4.2. System Setup**, select a memory and step that is suitable for the test you would like to perform.
2. Attach the appropriate DUT to the instrument (refer to section **5.1. Instrument Connections**).
3. Press the TEST button.
4. The instrument will now perform the test or connected sequence of tests. If the test is started from any other step than 01, the instrument will return to the originally selected step when you push RESET or TEST buttons.

- If a Prompt is embedded within a step, the test will pause at that step and display the Prompt as a pop-up message. An example of a prompt will appear as follows:

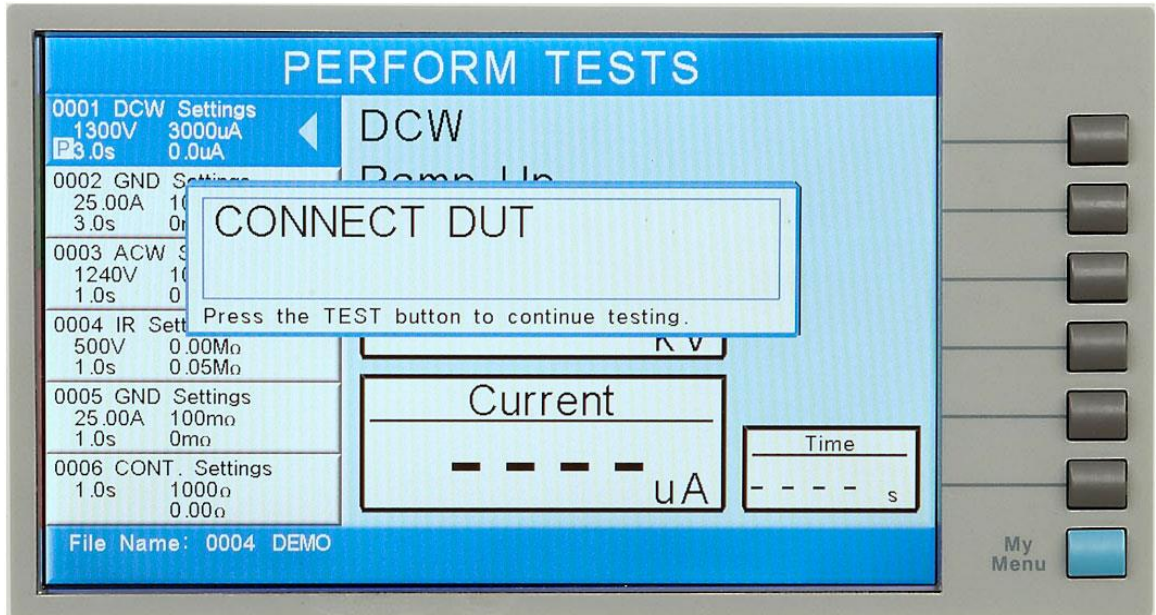

- In order to clear the Prompt and continue the test, push the TEST button. The highlighted area of the screen remains on the test that is being performed until it is finished. At the same time on the right half of the screen will be the appropriate metering display for the type of test that is being performed (refer to section 5.4. **Perform Tests Metering**). When the step is complete the highlighted area will sequence to the next step and the new metering display will appear (unless there is a prompt embedded within the step). When the highlighted area moves to the next step, the previous step area will now display the results of the test just performed.
- At the end of the test sequence, the right side of the screen will display a flashing PASS if all the tests have completed successfully or a flashing FAIL if any of the tests did not complete successfully. If a test fails, the right side of the screen will indicate the step that failed and which parameter of the step failed.

5.4. Perform Tests Metering

Each test performed by the OMNIA contains a unique set of parameters and therefore requires specialized metering for each test. The following table describes what meters will be displayed for each of the different test types.

METERING SCREENS 8204/8206/8207					
TEST TYPE	CURRENT(T)	CURRENT(R)	VOLTAGE	TIME	RESISTANCE
AC Withstand	X	X	X	X	
DC Withstand	X		X	X	
IR			X	X	X
Continuity				X	X
Ground Bond	X			X	X

ADDITIONAL METERING SCREENS MODELS 8206/8207						
TEST TYPE	VOLTAGE	CURRENT	POWER	TIME	PF	LEAKAGE
Run Test	X	X	X	X	X	X

ADDITIONAL METERING SCREENS MODELS 8206/8207					
TEST TYPE	VOLTAGE	LEAKAGE	TIME	MD-VOLT	I-MAX
Leakage Current	X	X	X	X	X

The meter layout on the Perform Tests screen can be customized to show the most relevant information in the larger meter windows. Please refer to **Section 4. Programming Instructions** for more information.

5.5. Displayed Messages

Directly above the Metering screens is the Test Status display. This portion of the display is active during the test and allows you to view the type of test being performed and status of the test step. At the end of a test, the Test Status display will either inform you that the test has passed or give a direct indication of the kind of failure that occurred during the test. The following is an example of the Test status display:

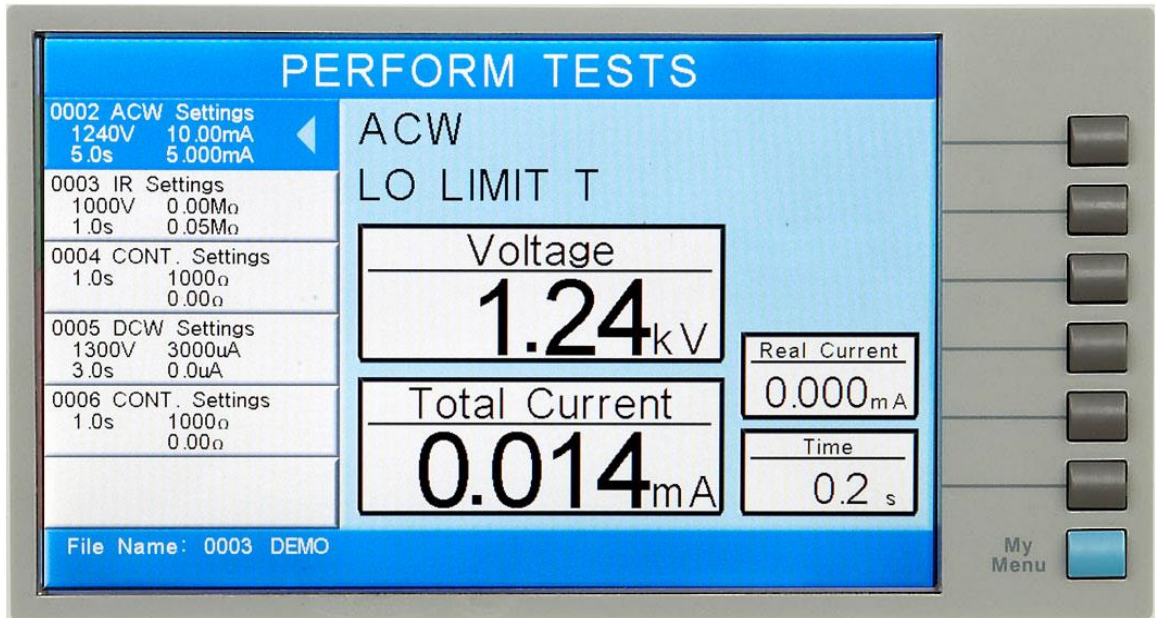

5.5.1. Test Status Messages

The following is a complete listing of the messages that appear in the Test status display and an explanation for each.

Dwell

This message appears on the display while a test is in process, the values update in real time.

Delay

This message appears on the display while a test is in process, the values update in real time.

Ramp Up

This message appears on the display at the beginning of the test, when the output voltage is ramping up.

Ramp Down

This message appears on the display at the end of the dwell cycle, when the output voltage is ramping down.

Pass

This message appears on the display when the test process is complete and the DUT passed the test.

5.5.2. Error Messages (All Models)

Abort

This message appears on the display if the test in process is aborted with the RESET button or remote Reset control.

HI-Limit

This message appears on the display if the DUT measurement exceeds the HI-Limit setting of any parameter (except AC withstand).

LO-Limit

This message appears on the display if the DUT measurement drops below the LO-Limit setting of any parameter (except AC withstand).

HI-Lmt T

This message appears on the display if the DUT leakage current exceeds the HI-Limit setting, of the Total current parameter in AC withstand.

LO-Lmt T

This message appears on the display if the DUT leakage current drops below the LO-Limit setting, of the Total current parameter in AC withstand.

HI-Lmt R

This message appears on the display if the DUT leakage current exceeds the HI-Limit setting, of the Real current parameter in AC withstand.

LO-Lmt R

This message appears on the display if the DUT leakage current drops below the LO-Limit setting, of the Real current parameter in AC withstand.

CONT-Fail

This message appears on the display if the DUT fails the basic Continuity check performed during an AC/DC Withstand test when Continuity is selected ON.

Arc-Fail

This message appears on the display if the DUT arcing current exceeds the Arc Sense limit (Arc Sense = 1...9) and the Arc function is active.

Short

This message appears on the display if the DUT current is well beyond the metering range of the test.

Charge-LO

This message appears on the display if the leakage current during Ramp-up falls below the Charge -LO setting.

Breakdown

This message appears on the display if the DUT current is well beyond the metering range of the test and the arcing condition beyond the arc sense limit.

Interlock Open

This message appears on the display if the Remote Interlock feature is activated before or during a test. The Remote Interlock feature utilizes a set of closed contacts

which will disable the instrument's output if they are opened before or during a test. Remote Interlock could also be referred to as a remote system lockout, utilizing "fail when open" logic. The Remote Interlock feature may be disabled by plugging the "Interlock Disable Key" provided into the Signal Input connector. See section 6.2 Remote Signal Inputs and Memory Access for more information.

GND-Fault

This message appears on the display if the GFI threshold is exceeded during the test.

Out-Error

This message appears on the display if the instrument's output reading does not match the set value. If the instrument has an output problem when the TEST button is pressed, the Output Error screen will appear as follows:

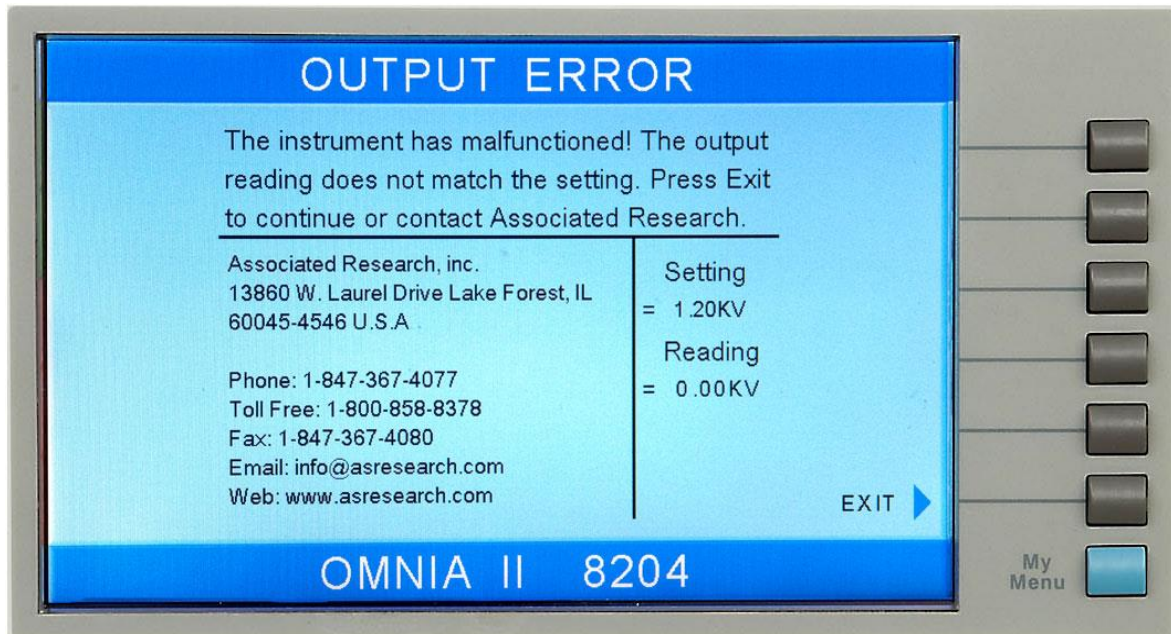

The RESET button is not active in this situation. Only the Exit soft key will allow you to return to the Perform Test screen.

OTP-Fail

This message appears on the display if the Power Amplifier has overheated. This is abnormal condition; please call to the factory for assistance.

5.5.3. Error Messages (Models 82x6 and 82x7)

Volt-HI

This message appears on the display if the DUT input voltage exceeds the Volt-HI Trip setting.

Volt-LO

This message appears on the display if the DUT input voltage drops below the Volt-LO Trip setting.

Amp-HI

This message appears on the display if the current exceeds the Amp-HI Trip setting.

Amp-LO

This message appears on the display if the current drops below the Amp-LO Trip setting.

Line-OC

This message appears on the display if the 20 Amp < 1 s, short circuit protection is tripped.

Watt-HI

This message appears on the display if the DUT input wattage exceeds the Watt-HI Trip setting.

Watt-LO

This message appears on the display if the DUT input wattage drops below the Watt-LO Trip setting.

PF-HI

This message appears on the display if the Power Factor exceeds the PF-HI Trip setting.

PF-LO

This message appears on the display if the Power Factor drops below the PF-LO Trip setting.

Leak-HI

This message appears on the display if the enclosure to neutral leakage current exceeds the Leak-HI Trip setting.

Leak-LO

This message appears on the display if the enclosure to neutral leakage current drops below the Leak-LO Trip setting.

Neutral-V

This message appears on the display if there is voltage present on the Neutral of the DUT input receptacle.

OCP

This message appears on the display if the maximum current draw exceeds the capability of the internal power source (>4.2A).

A-SHDN

This message appears on the display when the power amplifier shuts down. This is an abnormal condition; please call the factory for assistance.

Fatal Error

If the instrument has a recognizable internal component failure and the TEST button is pressed, the Fatal Error screen will appear as follows:



This type of failure permanently locks the instrument in the “Fatal Error” mode and requires that the instrument be serviced by Associated Research. The following Fatal Error identification numbers will represent the type of failure that has occurred:

Error Code 9001 will appear on the display if the instrument has a recognizable internal component failure.

Error Code 9002 will appear on the display if the instrument’s System Data or the Model/Option/Serial Number Data are corrupted and do not match the settings.

Error Code 9003 will appear on the display if the instrument’s Calibration Data is corrupted.

Error Code 9004 will appear on the display if communication to the Leakage Current card (LCT) has been lost

6. CONNECTION OF REMOTE I/O

Two 9-pin “D” type connectors mounted on the rear panel provide REMOTE-INPUT-OUTPUT control and information. These connectors mate with a standard 9 pin D-sub-miniature connector provided by the user. The output mates to a male (plug) connector while the input mates to a female (receptacle) connector. For best performance, a shielded cable should be used. To avoid ground loops the shield should not be grounded at both ends of the cable. Suggested AMP part numbers for interconnecting to the Remote I/O are shown below:

205204-4	PLUG SHELL WITH GROUND INDENTS
205203-3	RECEPTACLE SHELL
745254-7	CRIMP SNAP-IN PIN CONTACT (for plug)
745253-7	CRIMP SNAP-IN SOCKET CONTACT (for receptacle)
745171-1	SHIELDED CABLE CLAMP (for either plug or receptacle)
747784-3	JACKSCREW SET (2)

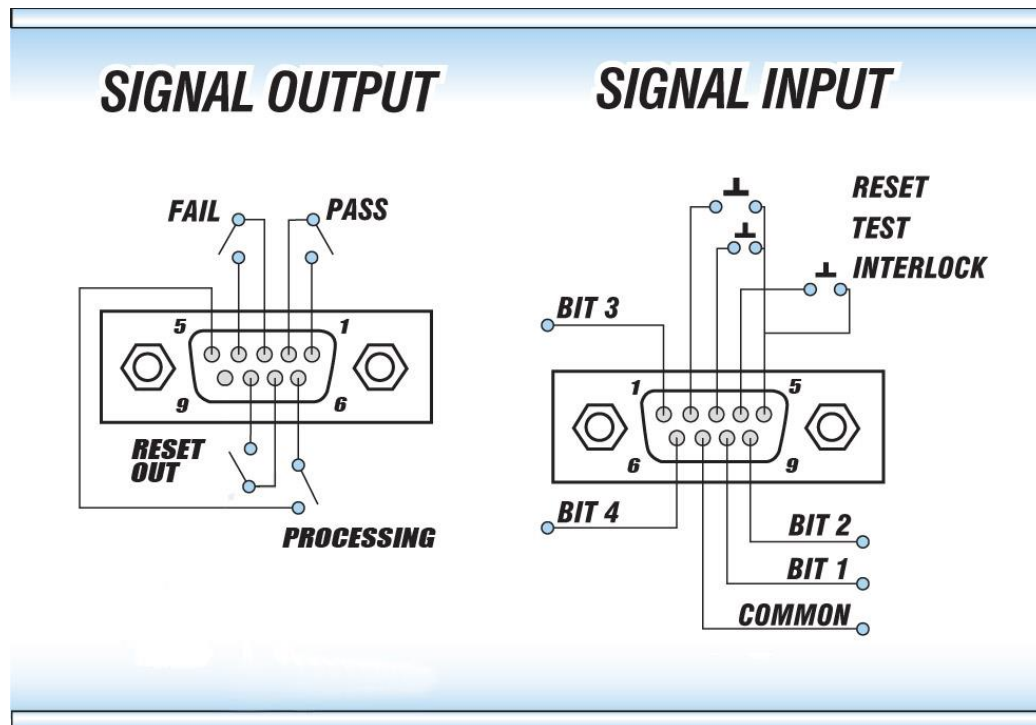

6.1. Remote Signal Outputs

The rear panel connector provides three output signals to remotely monitor PASS, FAIL, and PROCESSING conditions. The monitoring signals are provided by three normally open internal relays that toggle ON and OFF to indicate the condition of the tester. These are normally open free contacts and will not provide any voltage or current. The ratings of the contacts are 1 AAC / 125 VAC (0.5 ADC / 30 VDC). The signal outputs are provided on the 9-pin female “D” type connector. Below is a list that indicates what conditions activate each pin. When a terminal becomes active the relay closes thereby allowing the external voltage to operate an external device.

Pins 1 and 2 provide the PASS signal.
Pins 3 and 4 provide the FAIL signal.
Pins 5 and 6 provide the PROCESSING signal.
Pins 7 and 8 provide the RESET signal.

The following describes how the relays operate for each test condition:

PROCESSING – The relay contact closes the connection between pin (5) and pin (6) while the instrument is performing a test. The connection is opened at the end of the test.

PASS – The relay contact closes the connection between pin (1) and pin (2) after detecting that the item under test passed all tests. The connection is opened when the next test is initiated or the reset function is activated.

FAIL – The relay contact closes the connection between pin (3) and pin (4) after detecting that the item under test failed. The connection will open when the next test is initiated or the reset function activated.

RESET OUT – The relay contact closes the connection between pin (7) and pin (8) while the reset function is activated. This is only a continuous closure dependent on the length of time the reset button is held in an active state.

6.2. Remote Signal Inputs and Memory Access

The OMNIA remote connector enables remote operation of the TEST, RESET, and REMOTE INTERLOCK functions, and allows the operator to select one of 10 pre-programmed test files.

When the PLC Remote mode is on, the OMNIA will respond to simple switch or relay contacts closures. A normally open momentary switch can be wired across pins 3 and 5 to allow remote operation of the TEST function. A minimum pulse width or contact closure of 20mS is required to guarantee a test start. A normally open momentary switch can be wired across pins 2 and 5 to allow remote operation of the RESET function. A minimum pulse width or contact closure of 50mS is required to guarantee that a running test will abort. When the PLC remote function is (ON) the TEST switch on the front panel will be disabled to prevent a test from being activated through this switch. For safety, the front panel RESET switch remains active even when a remote reset switch is connected so that high voltage can be shut down from either location.

DID YOU KNOW?

The Remote Signal Input connector may be used with various accessories, including light curtains, foot switches, and safety probes. Contact Associated Research, Inc. for more information.

The Remote File Select function gives the user the capability to quickly change

parameters and initiate a test remotely. Ten pre-programmed test files can be accessed by connecting pins 1,6,8, and 9 to the common pin 7, in different combinations. The memory select bits should be set simultaneously and remain set for a minimum of 20ms to guarantee that the correct memory will be selected. However, the memory select bits may be set in sequential manner, provided that the time delay between each bit is less than 4ms. When the desired bit pattern has been established it should remain set for a minimum of 20ms to guarantee that the correct memory will be selected. The **Remote File Select Truth Table** (binary) shows the different combinations of momentary switch (relay) closures, and which memory programs that will be selected as the result. It may be necessary to "OR" the momentary switches (relay contacts) to prevent incorrect program selection due to timing errors.

REMOTE FILE SELECT TRUTH TABLE				
BIT 4	BIT 3	BIT 2	BIT 1	FILE #
0	0	0	1	01
0	0	1	0	02
0	0	1	1	03
0	1	0	0	04
0	1	0	1	05
0	1	1	0	06
0	1	1	1	07
1	0	0	0	08
1	0	0	1	09
1	0	1	0	10
1= Momentary Contact closure between BIT and COMMON				
0= No Contact closure between BIT and COMMON				

WARNING

THAT MEMORY

ACTIVATING MEMORY PROGRAM FUNCTIONS THROUGH THE REMOTE CONNECTOR, SELECTS THE PROGRAM AND STARTS THE TEST WHICH IS PREPROGRAMMED INTO

CAUTION

DO NOT CONNECT VOLTAGE OR CURRENT TO THE SIGNAL INPUTS, THIS COULD RESULT IN DAMAGE TO THE CONTROL CIRCUITRY.

Remote Interlock

OMNIA is equipped with a Remote Interlock feature. Remote Interlock utilizes a set of closed contacts to enable the instrument's output. If the Remote Interlock contacts are open the output of the instrument will be disabled. Remote Interlock could also be referred to as a remote system lockout, utilizing "fail when open" logic. If the Remote Interlock contacts are open and the TEST button is pushed, a pop-up message will be displayed on the screen for two seconds. The message will appear as follows:

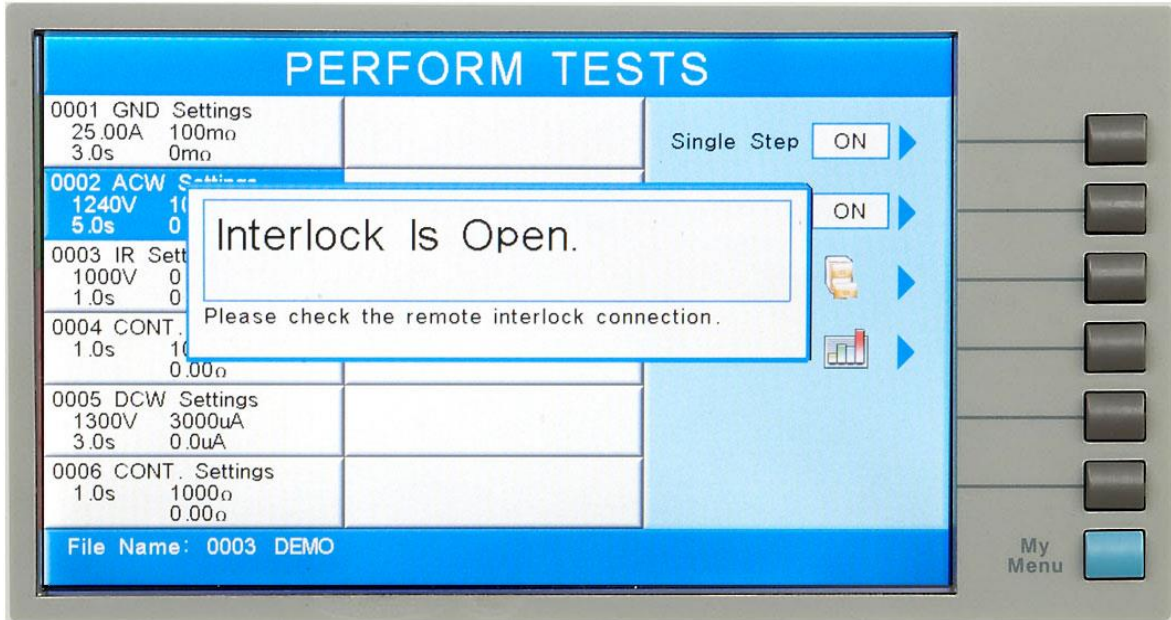

If the Remote Interlock contacts are opened during a test, the pop-up message will be displayed and the test will abort. The hardware and has been configured to provide the interlock connections on pins 4 and 5 of the Remote Interface, Signal Input port. The instrument can still be used without the external interlock device as long as the Interlock Disable Key (38075 provided with unit) is plugged into the Remote Interface, Signal Input port. If there is nothing connected to the Remote Interface, Signal Input port to provide a connection to the Remote Interlock, the instrument will not perform tests.



7. BUS REMOTE INTERFACE USB / GPIB / RS-232

This section provides information on the proper use and configuration of bus remote interface. The USB/RS-232 remote interface is standard on model 820X but the GPIB (IEEE-488) interface option can be substituted for the USB/RS-232 interface. Please refer to the Option section of this manual for details on the OMNIA options. The USB/RS-232 interface also uses the same command set as the GPIB interface for setting of test parameters. However there are many functions of the GPIB 488.2 interface that are not available through USB/RS-232. The IEEE-488 interface included with OMNIA conforms to the requirements of the IEEE-488.2 standard.

The USB/RS-232 interface card requires the user to download a driver in order for the instrument to recognize the USB interface. The driver can be found on the Associated Research, Inc. website:

<http://www.asresearch.com/products/software/USB-driver.aspx>

Click on “USB/RS-232 Driver” to download the driver. This link contains an automatic extract and install program. Follow the instructions of the installation program to initialize the driver install. NOTE: The USB port acts as a USB to RS-232 converter. As a result, the PC will recognize the USB port as a virtual COM port.

7.1. USB/RS-232 Interface

This interface provides all of the control commands and parameter setting commands of the GPIB interface with the exception of some of the 488.2 Common Commands and SRQ capability. All commands can be found in section **7.4. USB/RS-232/GPIB Command List**. The identification command *IDN and the Status Reporting commands are also available through USB/RS-232.

7.1.1. RS-232 Connector

The RS-232 cabling should be configured as follows for a 9-pin serial port interface:

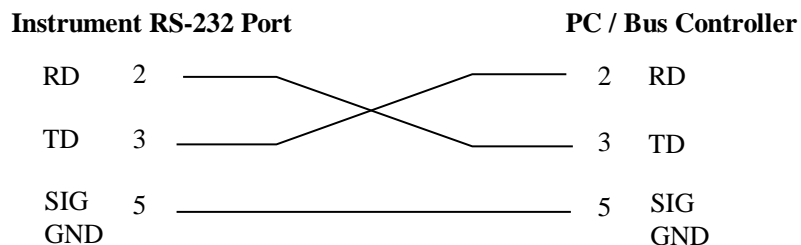

7.1.2. Communications Port Configuration

The COM port should have the following configuration:

- 9600 baud
- 8 data bits
- 1 stop bit

- No parity

This interface does not support XON/XOFF protocol or any hardware handshaking. The controller should be configured to ignore the handshaking lines DTR (pin 4), DSR (pin 6) CTS (pin 8) and RTS (pin 7). If the port cannot be configured through software to ignore these lines the handshake lines should be jumpered together in two different sets. Pins 4 and 6 should be jumpered together and pins 7 and 8 should be jumpered together at the controller end of the cable.

7.1.3. Sending and Receiving Commands

Sending Data

Once a command is sent to the instrument over the USB/RS-232 bus the instrument will send one of two responses. If the transfer was recognized and completed the instrument will return with 06 hex or 6 decimal, the Acknowledge (ACK) ASCII control code. If there is an error with the command string that is sent, the instrument will respond with 15 hex or 21 decimal, the Not Acknowledge (NAK) ASCII control code. The ACK or NAK response allows for software handshaking to monitor and control data flow.

Receiving Data

When requesting data from the instrument it will automatically send the data back to the controller input buffer. The controller input buffer will accumulate data being sent from the instrument, including the ACK and NAK response strings, until it has been read by the controller.

7.2. GPIB Interface

This interface is optional on the OMNIA and provides all of the control commands and parameter setting commands of the RS-232 interface along with 488.2 Common Commands and SRQ capability. All commands can be found in section **7.4. RS-232/GPIB Command List**.

7.2.1. GPIB Connector

Connection is usually accomplished with a 24-conductor cable with a plug on one end and a connector at the other end. Devices may be connected in a linear, star or a combination configuration.

The standard connector is the Amphenol or Cinch Series 57 Microribbon or AMP CHAMP type. The GPIB uses negative logic with standard transistor-transistor logic (TTL) levels. When DAV is true, for example, it is a TTL low level (≤ 0.8 V), and when DAV is false, it is a TTL high level (≥ 2.0 V).

Restrictions and Limitations on the GPIB

- A maximum separation of 4 m between any two devices and an average separation of 2 m over the entire bus.
- A maximum total cable length of 20 m.

- No more than 15 device loads connected to each bus, with no less than two-thirds powered on. For example 1 GPIB controller and a maximum of 14 GPIB instruments.
- **NOTE:** A bus extender, which is available from numerous manufacturers, is available to overcome these limitations.

7.2.2. GPIB Address

Each device on the GPIB (IEEE-488) interface must have a unique address. You can set the address of the OMNIA to any value between 0 and 30. The address can only be set from the front panel. The address is stored in non-volatile memory and does not change when the power has been off or after a remote reset.

- **The address is set to 8 when the instrument is shipped from the factory.**

7.3. Interface Functions

The capability of a device connected to the bus is specified by its interface functions. These functions provide the means for a device to receive, process, and send messages over the bus. The interface functions are listed in the chart below.

GPIB 488.1 INTERFACE FUNCTIONS

INTERFACE FUNCTION	SUBSET	DESCRIPTION
Source Handshake	SH1	Complete Source handshake capability
Acceptor Handshake	AH1	Complete Acceptor handshake capability
Talker	T6	Talker functions (unaddress if MLA)
Listener	L4	Listener functions (unaddress if MTA)
Service Request	SR1	Complete Service request capability
Remote Local	RL0	No remote/local capability
Parallel Poll	PP0	No parallel poll capability
Device Clear	DC1	Complete Device clear capability
Device Trigger	DT0	No device trigger capability
Controller	C0	No controller capability
Electrical Interface	E2	Three-state drivers
Controllable Items		Test and Reset control. Setting of test parameters for tests. Reading of instrument status and test results.
Data Codes	ASCII	
Delimiter	NL (+ EOI)	

7.4. USB / RS-232 / GPIB Interface Command List

7.4.1. Echo and Response Considerations

RS-232 Responses

The USB/RS-232 bus will automatically send any response back to the controller's input buffer.

GPIB Queries and Responses

The OMNIA GPIB bus will not send any data to the controller without being queried. A GPIB read command must be sent after a command string to retrieve any data from a query command (?).

Rules for Sending Commands to the Instrument

The following conventions are used to describe the commands syntax for the OMNIA:

- Braces ({ }) enclose each parameter for a command string.
- Triangle brackets (< >) indicate that you must substitute a value for the enclosed parameter.
- The Pipe (|) is used to separate different parameter options for a command.
- The command and the parameter data must be separated with a space.
- Each command string should be terminated by the ASCII control code, New Line (NL), (0Ah) or the end of line (EOL) message for GPIB.
- All commands that end with a question mark (?) are query commands and required an IEEE-488 read command to retrieve the data from the device's output buffer.

7.4.2. Test Execution Commands

The following commands are used to control actual output voltage and current from the instrument. Please observe all safety precautions.

COMMAND	DESCRIPTION
TEST	Execute a Test
RESET	Abort a test in Process or Reset Failures
SAO	Set Auto-Offset
SACG	Set Auto-Charge-LO

TEST

Starts the test sequence at the selected step loaded into memory (RAM).

RESET

Stop or abort a test. Also used to reset a latched failure condition.

SAO

Set the offset for the Ground bond test or Continuity test. The cables and any test fixture should be connected before executing the command. This command will

perform an actual test and all safety precautions should be observed when using this command.

SACG

Set the Charge-LO parameter for the DCW or IR test. The cables and any test fixture should be connected before executing the command. The test parameters that are set for the step will be used when performing the auto setting. This command will perform an actual test and all safety precautions should be observed when using this command.

7.4.3. File Editing Commands

The following commands are used to create or modify Test Setup Files.

COMMAND	DESCRIPTION	VALUE
FL nn	File Load nn	<i>nn = 01-9999</i>
FD	File Delete	Active selected File
FD nn	File Delete by Number	<i>nn = 01-9999</i>
FS	File Save	Active selected File
FSA nn,xxxx	File Save-as	<i>nn = 01-9999, xxx = name</i>
FN nn,xxxx	File New	<i>nn = 01-9999, xxxx = name</i>
SS nn	Step Select	<i>nn = 01-9999</i>
ADD <test,p1,p2,p3...>	Adds all parameters	
ADD2<test,p1,p2,p3...>	Adds all parameters	
SAA	Step Add ACW test	
SAD	Step Add DCW test	
SAI	Step Add IR test	
SAG	Step Add GND test	
SAC	Step Add CONT test	
SAGA	Step Add GND, ACW tests	
SAGD	Step Add GND, DCW tests	
SAR	Step Add RUN test	
SAL	Step Add LCT test	
SD	Step Delete	Active selected Step
SD nn	Step Delete by Number	<i>nn = 01-9999</i>

COMMAND	DESCRIPTION	VALUE
SP <prompt message>	Step Prompt Create	<i>prompt message</i> = Valid ASCII (1) maximum 31 characters
SP	Step Prompt Delete	
SF {1 0}	Step Fail Stop	1=On, 0=Off

(1) "Valid ASCII" is the character set that is available from the front panel LCD user interface. Consisting of upper case alphabet (A-Z), numbers (0-9) and decimal point (.), asteric (*), dash (-), underbar (_), tilde (~) and space (SP).

FL <file number>

Load a file from non-volatile memory into random access memory RAM.

FD

Deletes the file loaded into RAM from the non-volatile memory space as well as RAM. A new file must be loaded before and tests can be run.

FD <file number>

Deletes a file from non-volatile memory indicated by the file number.

FS

Saves the file from RAM to the non-volatile memory space.

FSA {<file number>,<file name>}

Saves the current file from RAM into the non-volatile memory space with the indicated file number and file name. The original file will not be modified with this operation. If there is a file already located at the desired number it will be moved to the next higher number and inserted in its place. New files may be added to the bottom of the file list but there must not be any numbers that do not have a file defined.

FN {<file number>,<file name>}

Creates a new file name at the specified file number. If there is a file already located at the desired number it will be moved to the next higher number and inserted in its place. New files can be added to the bottom of the file list but there must not be any numbers that do not have a file defined.

SS <step number>

Selects the active selected step to load into RAM. The step must first be selected before any specific parameters can be edited.

ADD <test,p1,p2,p3...>

This command inserts or adds a new step to the test sequence. This command will add or insert the test at the step location that has been selected. When a test has already been created at a selected step then the new step will be inserted and the previous step will move down to the next step and all other step will be renumbered accordingly.

The parameter <test> indicated the test type. The values ACW, DCW, IR, GND,

CONT, RUN or LCT must be used. The parameters <p1,p2> etc. indicate the individual settings for each test. All parameters must be included with the command and should appear in the same order that is shown on the actual setting screens. The correct order is shown in the tables below. When the scanner is installed it should be the last parameter for all test types except GND. For the GND test type, the scanner settings should be inserted between offset and frequency. The list of parameters can also be found in the default parameters section of the manual.

The parameter values should use complete text and not use the coded values that are associated with the individual parameter setting commands. Such as "ON" and "OFF" and any toggle field that use words or phrases like "OPEN", "CLOSE". The LS? companion command will also list all parameters in complete text as they appear on the setting screen.

	ACW	DCW	IR
1	Voltage	Voltage	Voltage
2	HI-Limit T	HI-Limit	HI-Limit
3	LO-Limit T	LO-Limit	LO-Limit
4	Ramp Up	Ramp Up	Ramp Up
5	Dwell Time	Dwell Time	Delay Time
6	Ramp Down	Ramp Down	Ramp Down
7	Arc Sense	Charge-LO	Charge-LO
8	HI-Limit Real	Arc Sense	DUT Output ¹
9	LO-Limit Real	Ramp-HI (ON/OFF)	Scanner Setup ²
10	Frequency	Arc Detect (ON/OFF)	
11	Arc Detect (ON/OFF)	Continuity (ON/OFF)	
12	Continuity (ON/OFF)	DUT Output ¹	
13	DUT Output ¹	Scanner Setup ²	
14	Scanner Setup ²		

	GND	CONT	RUN	LCT
1	Current	HI-Limit	Voltage-HI	Leakage-HI
2	Voltage	LO-Limit	Voltage-LO	Leakage-LO
3	HI-Limit	Dwell	Amp-HI	Voltage-HI
4	LO-Limit	Offset	Amp-LO	Voltage-LO
5	Dwell	Scanner Channel	Dwell Time	Delay Time
6	Offset	Continuity	Delay Time	Neutral (OPEN/CLOSED)
7	Scanner Channel		Leakage-HI	Reverse (ON/OFF)
8	Frequency		Leakage-LO	Ground (OPEN/CLOSED)

	GND	CONT	RUN	LCT
9			Power-HI	Meas. Device (UL544NP/UL544P/IEC601U L2601/ UL1563/IEC60990FIG4-U2/ IEC60990FIG5- U3/IEC60990FIG3-U1/ EXTERNAL)
10			Power-LO	Probe (Ground To Line/ Probe-HI to Line/Probe-HI To Probe- LO)
11			PF-HI	Leakage Mode (Peak/RMS)
12			PF-LO	PLC Control ³
13			Active Link	
14			PLC Control ³	

¹DUT Output is only a parameter in the ADD string if DUT HV = ON in the system settings menu

²Scanner Setup is only a parameter in the ADD string if either a scanner is installed (8204, 8254 w/ option 01) or a slave SC6540 scanner is connected to the Omnia unit.

³PLC Control is only available if option 04 (3 Remote Memory Send) or option 05 (7 Remote Memory Send) is installed.

Below are examples of the ADD command describing the order of parameters in the command string. The first string outlines the order of the parameters. The second string outlines an example with actual values for each parameter:

Adding an AC Withstand Test

ADD ACW,Voltage,HI-Limit T,LO-Limit T,Ramp Up,Dwell,Ramp Down,Arc Sense,HI-Limit R,LO-Limit R,Frequency,Arc Detect,Continuity,DUT Output,Scanner Setup

ADD ACW,1240,10.00,0.000,0.1,1.0,0.0,5,10.00,0.000,60,OFF,OFF,ON,O0000000

Adding a DC Withstand Test

ADD DCW,Voltage,HI-Limit,LO-Limit,Ramp Up,Dwell,Ramp Down,Charge LO,Arc Sense,Ramp-HI,Arc Detect,Continuity,DUT Output,Scanner Setup

ADD DCW,1200,10000,0.0,0.4,1.0,0.0,0.0,5,OFF,OFF,OFF,OFF,O0000000

Adding an Insulation Resistance Test

ADD IR,Voltage,HI-Limit,LO-Limit,Ramp Up,Delay,Ramp Down,Charge LO,DUT Output,Scanner Setup

ADD IR,1000,0.00,0.05,0.1,1.0,0.0,0.000,OFF,OOOOOOOO

Adding a Ground Bond Test

ADD GND,Current,Voltage,HI-Limit,LO-Limit,Dwell Time,Offset,Scanner Channel,Frequency

ADD GND,25.00,8.00,100,0,1.0,0,0,60

Adding a Continuity Test

ADD CONT.,HI-Limit,LO-Limit,Dwell,Offset,Scanner Channel,Continuity

ADD CONT.,1000,0.00,1.0,0.00,OOOOOOOO

Adding a Functional Run Test

ADD RUN,Voltage-HI,Voltage-LO,Amp-HI,Amp-LO,Dwell,Delay,Leakage-HI,Leakage-LO,Power-HI,Power-LO,PF-HI,PF-LO,Active Link,PLC Control

ADD RUN,125.0,0.0,10.00,0.00,1.0,0.2,10.00,0.00,1000,0,1.000,0.000,M1

Adding a Leakage Current test

ADD LCT,Leakage-HI,Leakage-LO,Voltage-HI,Voltage-LO,Delay,Neutral,Reverse,Ground,Meas. Device,Probe,Peak-RMS,PLC Control

ADD LCT,6000,0.0,125.0,0.0,1.0,CLOSED,OFF,CLOSED,UL544NP,Ground To Line,RMS,M1

ADD2

This command inserts or adds a new step to the test sequence. This command will add or insert the test at the step location that has been selected. When a test has already been created at a selected step then the new step will be inserted and the previous step will move down to the next step and all other step will be renumbered accordingly.

The parameter <test> indicated the test type. The values ACW, DCW, IR, GND, CONT, RUN or LCT must be used. The parameters <p1,p2> etc. indicate the individual settings for each test. All parameters must be included with the command and should appear in the same order that is shown on the actual setting screens. The correct order is shown in the tables below. When the scanner is installed it should be the last parameter for all test types except GND. For the GND test type, the scanner settings should be inserted between offset and frequency. The list of parameters can also be found in the default parameters section of the manual.

The parameter values should use complete text and not use the coded values that are associated with the individual parameter setting commands. Such as "ON" and "OFF"

and any toggle field that use words or phrases like "OPEN", "CLOSE". The LS2? companion command will also list all parameters in complete text as they appear on the setting screen.

	ACW	DCW	IR
1	Voltage	Voltage	Voltage
2	HI-Limit T	HI-Limit	HI-Limit
3	HI-Limit R	LO-Limit	LO-Limit
4	Ramp Up	Ramp Up	Ramp Up
5	Dwell Time	Dwell Time	Dwell Time
6	Ramp Down	Ramp Down	Delay Time
7	Arc Sense	Charge-LO	Ramp Down
	ACW	DCW	IR
8	LO-Limit T	Arc Sense	Charge-LO
9	LO-Limit R	Offset	DUT Output ¹
10	Offset	Ramp HI	Scanner ²
11	Frequency	Arc Detect	
12	Arc Detect	Continuity (ON/OFF)	
13	Continuity (ON/OFF)	DUT Output ¹	
14	DUT Output ¹	Scanner ²	
15	Scanner ²		

	GND	CONT	RUN	LCT
1	Current	HI-Limit	Voltage-HI	Leakage-HI
2	Voltage	LO-Limit	Voltage-LO	Leakage-LO
3	HI-Limit	Dwell	Amp-HI	Voltage-HI
4	LO-Limit	Offset	Amp-LO	Voltage-LO
5	Dwell	Scanner	Dwell Time	Dwell Time
6	Offset	Continuity	Delay Time	Delay Time
7	Scanner		Leakage-HI	LCT Offset
8	Frequency		Leakage-LO	Neutral (<i>OPEN/CLOSED</i>)
9	Dual-Chek		Power-HI	Reverse (<i>ON/OFF</i>)
10			Power-LO	Ground (<i>OPEN/CLOSED</i>)
11			PF-HI	Meas. Device (<i>UL544NP/UL544P/IEC60601UL2601/ UL1563/IEC60990FIG4-U2/ IEC60990FIG5-U3/ EXTERNAL/Frequency Check</i>)
12			PF-LO	Probe (<i>Ground To Line/ Probe-HI to Line/Probe-HI To Probe-LO</i>)
13			Active Link	Leakage Mode (<i>Peak/RMS</i>)
14			PLC Control	Active Link

			Voltage ³	
15			Frequency	AC/DC
16			A-Hi	Ranging Mode
17			Output N/G	PLC Control Voltage ³
18			Volt-Range	Frequency
19			OC-Fold	A-Hi
20				Output N/G
21				Volt Range
22				OC-Fold
23				Scanner Setup

¹DUT Output is only a parameter in the ADD string if DUT HV = ON in the system settings menu

²Scanner Setup is only a parameter in the ADD string if either a scanner is installed (8204, 8254 w/ option 01) or a slave SC6540 scanner is connected to the Omnia unit.

³PLC Control is only available if option 04 (3 Remote Memory Send) or option 05 (7 Remote Memory Send) is installed.

Below are examples of the ADD2 command describing the order of parameters in the command string. The first string outlines the order of the parameters. The second string outlines an example with actual values for each parameter:

Adding an AC Withstand Test

ADD2 ACW,Voltage,HI-Limit T,LO-Limit T,Ramp Up,Dwell Time,Ramp Down,Arc Sense,HI-Limit R,LO-Limit R,Offset,Frequency,Arc Detect,Continuity,DUT Output,Scanner Setup

ADD2

ACW,1240,10.00,0.000,0.1,1.0,0.0,5,10.00,0.000,0.000,60,OFF,OFF,ON,OOOOOOO
O

Adding a DC Withstand Test

ADD2 DCW,Voltage,HI-Limit,LO-Limit,Ramp Up,Dwell,Ramp Down,Charge LO,Arc Sense,Offset,Ramp-HI,Arc Detect,Continuity,DUT Output,Scanner Setup

ADD2 DCW,1200,10000,0.0,0.4,1.0,0.0,0.0,5,0.0,OFF,OFF,OFF,OFF,OOOOOOOO

Adding an Insulation Resistance Test

ADD2 IR,Voltage,HI-Limit,LO-Limit,Ramp Up,Dwell Time,Delay Time,Ramp Down,Charge LO,DUT Output,Scanner Setup

ADD2 IR,500,0.00,0.05,0.1,0.5,1.0,0.0,0.000,OFF,OOOOOOOO

Adding a Ground Bond Test

ADD2 GND,Current,Voltage,HI-Limit,LO-Limit,Dwell Time,Offset,Scanner Channel,Frequency,DualCHECK

ADD2 GND,25.00,8.00,100,0,1.0,0,0,60,OFF

Adding a Continuity Test

ADD2 CONT,HI-Limit,LO-Limit,Dwell,Offset,Scanner Channel,Continuity

ADD2 CONT.,1000,0.00,1.0,0.00,OOOOOOOO

Adding a Functional Run Test

ADD2 RUN,Voltage-HI,Voltage-LO,Amp-HI,Amp-LO,Dwell,Delay,Leakage-HI,Leakage-LO,Power-HI,Power-LO,PF-HI,PF-LO,Active Link,PLC Control,Voltage,Frequency,A-Hi,Output N/G,Volt Rang,OC-Fold

ADD2 RUN,125.0,0.0,10.00,0.00,1.0,0.2,10.00,0.00,1000,0,1.000,0.000,OFF,M1

Adding a Leakage Current test^{1,2}

ADD2 LCT,Leakage-HI,Leakage-LO,Voltage-HI,Voltage-LO,Dwell Time,Offset,Delay Time,Neutral,Reverse,Ground,Meas.Device,Probe,Peak/RMS,Active Link,AC/DC,Ranging Mode,PLC Control,Scanner Setup

ADD2 LCT,6000,0.0,125.0,0.0,0.5,1.0,0.0,1.0,CLOSED,OFF,CLOSED,UL544NP,Ground To Line,RMS,OFF,AC+DC,Auto,M1,OOOOOOOO

¹PLC Control is only available if option 04 (3 Remote Memory Send) or option 05 (7 Remote Memory Send) is installed.

²Please refer to the table above for additional optional parameters available with installed options.

SAA, SAD, SAI, SAG, SAC, SAGA, SAGD, SAL, SAR

These commands insert or add a new step to the test sequence. This command will add or insert the test at the step location that has been selected. When a test has already been created at a selected step then the new step will be inserted and the previous step will move down to the next step and all other step will be renumbered accordingly. See the command summary tables to see the specific test type for each of these commands.

SD

Deletes the active step from the setup file sequence. All step after this step will move up and be renumbered accordingly.

SD <step number>

Deletes the step indicated by the number from the setup file sequence. All step after this step will move up and be renumbered accordingly.

SP <prompt message>

Adds or edits a prompt message for the active step.

SP

Removes or deletes the prompt that had been created for the active step.

SF {1|0}

Sets the Fail Stop function OFF or ON for the active setup file loaded into RAM. 1 sets the Fail Stop = ON, 0 sets the Fail Stop = OFF.

7.4.4. Test Parameter Editing Commands and Companion Queries

These commands are used to modify the test parameter within each step. These commands require a parameter value to be included with the command. The companion query command will read the parameter. The writing of the parameter requires that the unit not be included with the value, only the numeric value should be included with the command. Also when the query commands are used the response will not include the units characters. Many of the commands will function the same way for multiple test types however the input range may be different and therefore used a different possible set of values.

COMMAND	NAME	TEST TYPES	VALUE
EA < value > EA?	Edit Arc	ACW DCW	1 - 9
EAD {1 0} EAD?	Edit Arc-Detect	ACW DCW	1= On, 0=Off
ECG < value > ECG?	Edit Charge-Lo	DCW IR	0.000 - 3.5000uA 0.0 - 350uA
ECT {1 0} ECT?	Edit Continuity	ACW DCW	1= On, 0=Off

COMMAND	NAME	TEST TYPES	VALUE
EC < value > EC?	Edit Current	GND	1.00 - 40.00A
ECH < value > ECH?	Edit Current-HI	RUN	0.00 - 16.00A
ECL < value > ECL?	Edit Current-Lo	RUN	0.00 - 16.00A
EDE < value > EDE?	Edit Delay	IR RUN LCT	0.0 - 999.9s
EDO {1 0} EDO?	Edit DUT-Output Voltage	ACW DCW IR	1= On, 0=Off
EDW < value > EDW?	Edit Dwell	ACW DCW GND CONT RUN	0.0 - 999.9s
EF {1 0} EF?	Edit Frequency	ACW GND	1=60Hz, 0=50Hz, 2=400Hz (option), 3=800Hz (option), 4=SYNC
EG {1 0} EG?	Edit Ground	LCT	1=Open, 0=Close
EH < value > EH?	Edit HI-Limit	DCW IR GND CONT	0.0 - 20000uA 0.05 - 50000MΩ 0 - 600mΩ 0.00 - 10.00Ω
EHR < value > EHR?	Edit HI-Limit-R	ACW	0.000 - 50.00mA, 99.99mA (Models 825x)
EHT < value > EHT?	Edit HI-Limit-T	ACW	0.000 - 50.00mA, 100.00mA (Models 825x)
EL < value > EL?	Edit LO-Limit	DCW IR GND CONT	0.0 - 20000uA 0.05 - 50000Ω 0 - 600mΩ 0.00 - 10000Ω
ELR < value > ELR?	Edit LO-Limit-R	ACW	0.000 - 50.00mA, 99.99mA (Models 825x)
ELT < value > ELT?	Edit LO-Limit-T	ACW	0.000 - 50.00mA, 100.00mA (Models 825x)
ELM {1 0} ELM?	Edit Leakage Mode	LCT	1=Peak, 0=RMS

COMMAND	NAME	TEST TYPES	VALUE
EM {0 1 2 3 4 5 6 7 8 9} EM?	Edit Measuring Device	LCT	0=UL544NP 1=UL544P 2=IEC60601-1, UL2601-1 3=UL1563 4=IEC60990 FIG4-U2, IEC 60950 5=External 6=Frequency Check 7=IEC60990 FIG5-U3 8=NAK 9=IEC60990 FIG4-U1, IEC 60950
EN {1 0} EN?	Edit Neutral	LCT	1=Open, 0=Close
EO < value > EO?	Edit Offset	GND CONT	0 - 200mΩ 0.00 - 10.00Ω
EPFH < value > EPFH?	Edit PF-HI	RUN	0.000 - 1.000
EPFL < value > EPFL?	Edit PF-LO	RUN	0.000 - 1.000
EPOH < value > EPOH?	Edit Power-HI	RUN	0 - 4500W
EPOL < value > EPOL?	Edit Power-LO	RUN	0 - 4500W
EP {0 1 2} EP?	Edit Probe	LCT	0=Ground to Line 1=Probe-HI to Line 2=Probe-HI to Probe-LO
ERD <value > ERD?	Edit Ramp-Down	ACW DCW IR	0.0 - 999.9s
ERH {1 0} ERH?	Edit Ramp-HI	DCW	1= On, 0=Off
ERU < value> ERU?	Edit Ramp-Up	ACW DCW IR	0.0 - 999.9s
ER {1 0} ER?	Edit Reverse	LCT	1= On, 0=Off
EACDC n	Edit AC/DC Filter	LCT	n=0-2 0=AC+DC, 1=AC,2=DC
EACDC?	Edit AC/DC?		
ERM n ERM?	Edit Range Mode	LCT	n=0-1 1= Auto, 0=Manual

COMMAND	NAME	TEST TYPES	VALUE
EAIH nnnn EAIH?	Edit A-Hi	LCT	Volt Range High=0.00~2.10A Voltage Range Low=0.00~2.2A
EONG n EONG?	OUTPUT N/G	LCT	n=1 or 0 1=Open, 0=Close
EVR n EVR?	Volt Range	LCT	n=1 or 0 1=HIGH, 0=LOW
EOCF n EOCF?	OC Fold	LCT	n=1 or 0 1=ON, 0=OFF
SAGA	Step ADD: GND,ACW	DualCheck	
SAGD	Step ADD:GND,DCW	DualCheck	
ES <scanner string> ES?	Edit Scanner High Voltage Multi-port	ACW DCW IR	scanner string = 1-16 element ASCII string consisting of H, L, or O. H=HV, L=RETURN, O=OPEN
ESN <value> ESN?	Edit Scanner Low Voltage Single- port	GND CONT	value = 0 - 16, 0 = ALL OPEN
EV <value> EV?	Edit Voltage	ACW DCW IR GND	1 - 5000V 1 - 6000V 1 - 1000V 3.00 - 8.00V
EVH < value > EVH?	Edit Voltage-Hi	RUN LCT	0.0 - 277.0V
EVL < value > EVL?	Edit Voltage-Lo	RUN LCT	0.0 - 277.0V
EO < value > EO?	Edit Offset	ACW DCW GND CONT	0-50mA 0-20000uA 0-200mΩ 0-10.00Ω
SN < value > SN?	Edit Step Name	ACW DCW IR GND CONT	20 character max
EDC < value > EDC?	Edit Dual Chek	GND	0 = off, 1 = ACW, 2 = DCW

EDOC

This command is used to control the Continuity and Ground Bond tests at the DUT outputs of the LCT and RUN test interface. It should only be used when Continuity or

Ground Bond tests are routed through the HS-16 external, PC controlled scanner. When the EDOC command is set to 0 the Continuity or Ground Bond test will be disconnected from the GND and Case terminals of the DUT-outputs to eliminate possible parallel paths with the scanner outputs.

7.4.5. System Parameter Editing Commands and Companion Queries

These commands are used to modify the system parameters for the instrument. These commands require a parameter value to be included with the command. The companion query command will read the parameter using the same value that is used for setting the parameter.

COMMAND	NAME	VALUE
SA < value > SA?	Alert Date	mm,dd,yy or yy,mm,dd or dd,mm,yy ; same as SDF setting
SACS SACS?	System AC Source	1=On, 0=Off
SAL < value > SAL?	Alarm Volume	0-9
SCA {1 0} SCA?	Cal Alert	1= On, 0=Off

COMMAND	NAME	VALUE
SCDA < value > SCDA?	Cal Date	mm,dd,yy or yy,mm,dd or dd,mm,yy ; same as SDF setting
SCDU < value > SCDU?	Cal Due	mm,dd,yy or yy,mm,dd or dd,mm,yy ; same as SDF setting
SDAY {6 5 4 3 2 1 0} SDAY?	Day of the week	0,1,2,3,4,5,6= Sun,M,T,W,T,F,Sat
SDF < value > SDF?	Date Format	0=yy,mm,dd, 1=mm,dd,yy 2=dd,mm,yy
SDH{1 0} SDH?	DUT-HV	1= On, 0=Off
SDS SDS?	System Continuity Scanner	0=HV Channel 1=GND Channel
SDT < value > SDT?	Date	mm,dd,yy or yy,mm,dd or dd,mm,yy ; same as SDF setting
SF {1 0} SF?	Fail Stop	1= On, 0=Off
SL {1 0} SL?	Lock	1= On, 0=Off
SM {1 0} SM?	System Measurement	0 = True RMS, 1 = Average

SMM {2 1 0} SMM?	Main Menu page	2 = My Menu, 1= Perform Tests, 0=Menu
SPR {1 0} SPR?	PLC Remote	1= On, 0=Off
SSG {1 0} SSG?	Smart GFI	1= On, 0=Off
SSG2 < value > SSG2?	Smart GFI value	0.4 – 5.0, 0
SSI {1 0} SSI?	Single Step	1= On, 0=Off
STM < value > STM?	Time	hh,mm (24hr) hh,mm,AM or hh,mm,PM (12hr) according to STF setting
STF {1 0} STF?	Time Format	0=12hr, 1=24hr
CAD {1 0} CAD?	System Alert Date	1 = On, 0 = Off
SAN {1 0} SAN?	Set Animation	2 = Skip, 1 = On, 0 = Off
SLA < value > SLA?	Set Language	0 = English, 1 = Traditional Chinese, 2 = Simplified Chinese, 3 = Spanish, 4 = Portuguese, 5 = Turkish, 6 = German, 7 = French
COMMAND	NAME	VALUE
SCS < value > SCS?	Set Color Scheme	3 = Midnight, 2 = Arctic, 1 = Granite, 0 = Basic
SSN {1 0} SSN?	Set Step Name	1 = On, 0 = Off
SUL < value >?	Current User	0 – 8
SUA < p, p, p, p >	Add User	Pointer, name, password, level Pointer: 1-8 Name: 8 character max Password: 8 character max Level: 0 = Run only, 1 = Recall step, 2 = Edit step, 3 = full system
SUD < value >	Delete User	1 – 8
SUE < p, p, p, p >	Edit User	Pointer, name, password, level Pointer: 1-8 Name: 8 character max Password: 8 character max

		Level: 0 = Run only, 1 = Recall step, 2 = Edit step, 3 = full system
--	--	--

7.4.6. Query Commands

These query commands will retrieve data from the instrument. The GPIB bus application requires an IEEE-488 read command to be sent after the query command. These commands include functions for retrieving test data, test results and remote hardware status as well as setup file information.

COMMAND	NAME	VALUE
TD?	List Testing Data	Test In Process
RD nn?	List Results Data	nn = 1-10000
RR?	Read Remote Reset	1=Open, 0=Closed
RI?	Read Remote Interlock	1=Open, 0=Closed
LF?	List File Name	Active selected file
LF nn?	List File Name by file number	nn = 1-10000
LP?	List Prompt	Active selected Step
LP nn?	List Prompt by step number	nn = 1-10000
FT?	File Total quantity stored	
ST?	Step Total quantity in file	
LS?	List Step Parameters	
LS <step number>?	List Step Parameters by step number	step number = 1-30
LS2 < step number>?	List Step Parameters by step number	Step number = 01-9999
RS?	Read scanner port status	0 = none, 1 = external 1, 2 = external 2, 3 = both
SS?	Select Step	nn = 01-9999

TD?

Read the active data being displayed on the LCD display while the test is in process. Will also read the last data taken when the test sequence has completed. Each parameter is separated by commas and includes step number, test type, test status, and metering. The syntax for this command response is {step, test type, status, meter 1, meter 2, meter 3}. ACW test displays 4 meters. Each meter will contain only the value and not the units. In the case of DCW current where both uA and mA are used on the display, the command response will always indicate the current in uA for example 2.0mA will respond with 2000 for 2000uA.

RD <step number>?

Read the results for an individual step. The step number is the actual step number that has been saved within the file, not the order of which the steps were executed.

For example if the test was executed starting from step 3 and ending with step 5 then the first step test results will be found in location 3 not in location 1. Each parameter is separated by commas and includes step number, test type, test status, and metering. The syntax for this command response is {step, test type, status, meter 1,meter 2,meter 3}. ACW test displays 4 meters. Each meter will contain only the value and not the units. In the case of DCW current where both uA and mA are used on the display the command response will always indicate the current in uA for example 2.0mA will respond with 2000 for 2000uA.

RR?

Read the remote Reset input signal. When the remote reset has been activated by closing the contacts the query will return a value of 1 to indicate the instrument is being Reset.

RI?

Read the remote Interlock input signal. When the remote Interlock has been activated by opening the contacts the query will return a value of 0 to indicate the instrument is in the Interlock state and will not be able to generate output voltage or current.

LF?

Lists the file name of the file loaded into active memory (RAM).

LF <file number>?

List the file name of any saved file within the directory structure. The file number is given to the file when the file is saved into non-volatile memory.

LP?

Lists the prompt that is created for the individual step that has been selected within active memory (RAM).

LP <step number>?

Lists the prompt that has been created for one of the steps of the file within active memory (RAM).

FT?

Returns the total quantity of files stored in memory.

ST?

Returns the total quantity of steps created in the file.

LS?

Lists all the Parameters for the individual step that is currently selected.

The response will be formatted as follows; **<step, test, p1, p2, p3...>** Where **<step>** is the step number, **<test>** is the test type and **<p1,p2>** etc., indicates the parameters of the test. Please refer to the ADD command for a list of parameters for each test type.

LS <step number>?

Lists all the Parameters for the individual step indicated by **step number = 1-30**.

The response will be formatted as follows; **<step, test, p1, p2, p3...>** Where *<step>* is the step number, *<test>* is the test type and *<p1,p2>* etc., indicates the parameters of the test. Please refer to the ADD command for a list of parameters for each test type.

LS2?

Lists all the Parameters for the individual step that is currently selected.

The response will be formatted as follows; **<step, test, p1, p2, p3...>** Where *<step>* is the step number, *<test>* is the test type and *<p1,p2>* etc., indicates the parameters of the test. Please refer to the ADD command for a list of parameters for each test type.

LS2 <step number>?

Lists all the Parameters for the individual step indicated by *step number = 1-30*.

The response will be formatted as follows; **<step, test, p1, p2, p3...>** Where *<step>* is the step number, *<test>* is the test type and *<p1,p2>* etc., indicates the parameters of the test. Please refer to the ADD command for a list of parameters for each test type.

RS?

Reads the instrument's scanner port status. The query will return either a 0 (none), 1 (external 1), 2 (external 2) or 3 (both external 1 and 2) which describes the number of local scanners connected to the instrument.

SS?

Reads the selected step from the instrument.

7.4.7. IEEE 488.2 Common Commands

These commands are required by the IEEE-488.2 standard with the exception of *PSC, *PSC?. Most of these commands are not available over the RS-232 bus except for the *IDN? command which can be used to retrieve the instrument identification information, and the four status reporting commands *ESR?, *ESE, *ESE? and *STB?.

COMMAND	NAME	DESCRIPTION
*IDN?	Identification Query	ARI, Model Number, Serial Number, Firmware Revision
*RST	Reset Command	Resets OMNIA
*TST?	Self-Test Query	00H=OK 01H=TEST EEPROM ERROR
*CLS	Clear Status Command	Clear Standard Event Status Register Clear Service Request Register
*OPC	Operation Complete Command	When TEST command ok setting ESR BIT0 =1
*OPC?	Operation Complete Query	1 = TEST completed ok 0 = TEST in process
*WAI	Wait-to-Continue Command	
*PSC {1 0}	Power-on Status Clear Command	1 = Power-on clear enable

		registers 0 = Power-on load previous enable registers
*PSC?	Power-on Status Clear Query	
*ESR?	Standard Event Status Register Query	0 - 255
*ESE <value>	Standard Event Status Enable Command	value = 0 - 255
*ESE?	Standard Event Status Enable Query	0 - 255
*STB?	Read Status Byte Query	Read Status Byte
*SRE <value>	Service Request Enable Command	value = 0 - 255
*SRE?	Service Request Enable Query	0 - 255

***IDN?**

Read the instrument identification string. Company =ARI.

***RST**

Reset the instrument to original power on configuration. Does not clear Enable register for Standard Summary Status or Standard Event Registers. Does not clear the output queue. Does not clear the power-on-status-clear flag.

***TST?**

Performs a self test of the instrument data memory. Returns 0 if it is successful or 1 if the test fails.

***CLS**

Clears the Status Byte summary register and event registers. Does not clear the Enable registers.

***OPC**

Sets the operation complete bit (bit 0) in the Standard Event register after a command is completed successfully.

***OPC?**

Returns an ASCII "1" after the command is executed.

***WAI**

After the command is executed, it prevents the instrument from executing any further query or commands until the no-operation-pending flag is TRUE.

***PSC {1|0}**

Sets the power-on status clear bit. When set to 1 the Standard Event Enable register and Status Byte Enable registers will be cleared when power is turned ON. 0 setting indicates the Enable registers will be loaded with Enable register masks from non-volatile memory at power ON.

***PSC?**

Queries the power-on status clear setting. Returns 0 or 1.

***ESR?**

Queries the Standard Event register. Returns the decimal value of the binary-weighted sum of bits.

***ESE <value>**

Standard Event enable register controls which bits will be logically OR'd together to generate the Event Summary bit 5 (ESB) within the Status Byte.

***ESE?**

Queries the Standard Event enable register. Returns the decimal value of the binary-weighted sum of bits.

***STB?**

Read the Status Byte. Returns the decimal value of the binary-weighted sum of bits.

***SRE <value>**

Service Request enable register controls which bits from the Status Byte should be use to generate a service request when the bit value = 1.

***SRE?**

Queries the Service Request enable register. Returns the decimal value of binary-weighted sum of bits.

7.4.8. Status Reporting

The status reporting system is a way of determining the condition of the tester and is configured using two types of registers. An Event register and a Summary register. The Summary register is known as the Status Byte register and records high-level summary information acquired by the Event registers.

An Event register report defines conditions or messages at each bit. The bits are latched and remain in an active state until the register is either Read or Cleared. Reading the Event register automatically clears the register and sets all bits to an inactive state or 0. When querying an Event register the information is returned as a decimal number representing the binary-weighted sum of all bits within the register.

The Enable register bits represent the selection of bits that will be logically OR'd together to form the summary bit in the Status Byte. The *CLS command will not clear the Enable registers and if you wish to clear the register you must set it to a value of 0. Like the Event register, the Enable register is represented as a decimal number that equals the binary-weighted sum of all bits.

The Enable register will clear to a value of 0 at power-on unless the *PSC 0 command has been executed before power-off. The *PSC command tells the device whether or

not it should clear the Enable registers at power-on. Using this command will allow SQRs to function immediately after power-on.

Bit	Binary weight	EVENT REGISTER		STATUS BYTE REGISTER	
		Event Register	Enable Register	Summary Register	Enable Register
0	1	Operation Complete		ALL PASS	
1	2	not used		FAIL	
2	4	Query Error		ABORT	
3	8	Device Error		TEST IN PROCESS	
4	16	Execution Error		Message Available (MAV)	
5	32	Command Error		Event Summary Bit (ESB)	
6	64	not used		Request Service (RQS) or Master Summary Status (MSS)	not used
7	128	Power On		PROMPT	

*ESR?

*ESE
*ESE?

*STB? | SPOLL

*SRE
*SRE?

7.4.9. GPIB Service Request

The service request capability is not available with the RS-232 interface. The SRQ line will be activated only after one or more of the service request functions have been enabled using the Status Byte Enable register command *SRE.

The Status Byte bit assignments are as described in the previous section for status reporting. When the instrument has requested service, the enabled bit or bits and the RQS bit 6 will be active or 1. Bits 4, 5, and 7 are not used and will be set to false, or 0 for all Status Byte reads.

After the serial poll (SPOLL) is executed the RQS bit will be cleared to 0 and the remaining bits will remain unchanged. The Status Byte will not change value until the Event register is read and cleared for the corresponding Status Byte bit.

For example, after the All Pass SRQ has been enabled, when the test(s) have finished with pass indications the instrument will set the hardware SRQ line and output the Status Byte of 41 hex. This means that bit 6 and bit 0 are set to a value of 1. After reading the Status Byte the Status Byte value will change to 01 hex.

7.5. Non Volatile Memory

The instrument saves or deletes each parameter in non-volatile memory when the file save "FS", file save as "FSA", file new "FN" and file delete "FD" commands are used to save, create and delete the files. The non-volatile memory has a limited write cycle life. Therefore, for programmers who wish to send all parameters before executing each test, the following commands should not be used:

FS – File Save

FSA – File Save As

FN – File New

FD – File Delete

The parameters will be stored in the CPU's Random Access Memory (RAM) until another memory location is selected. However, settings written to RAM from GPIB/USB/RS-232 mode will be lost when power is shut down. Parameter changes to RAM are unlimited and will not affect the life of the internal non-volatile memory chip.

A flowchart for an example program is shown on the next page. This flowchart exhibits how a program could be written to minimize wear to the write life cycle of the non-volatile memory. First, the "FN" command is used to create a blank file. In this case, the file is named TEMP. This file is then stored into the memory of the 620L. When the sequence needs to be recalled, the "FL" (File Load) command is used to recall the TEMP file. This creates a blank test sequence and steps can be added as necessary. Then the steps are added to the file via the "ADD" command and the sequence is executed. Programming in this fashion, the "FN" command is only used once to create a sequence. Then that sequence can be constantly loaded with the "FL" command

and added to with the “ADD” command. This will avoid constantly writing to the non-volatile memory.

Programming flow Charts

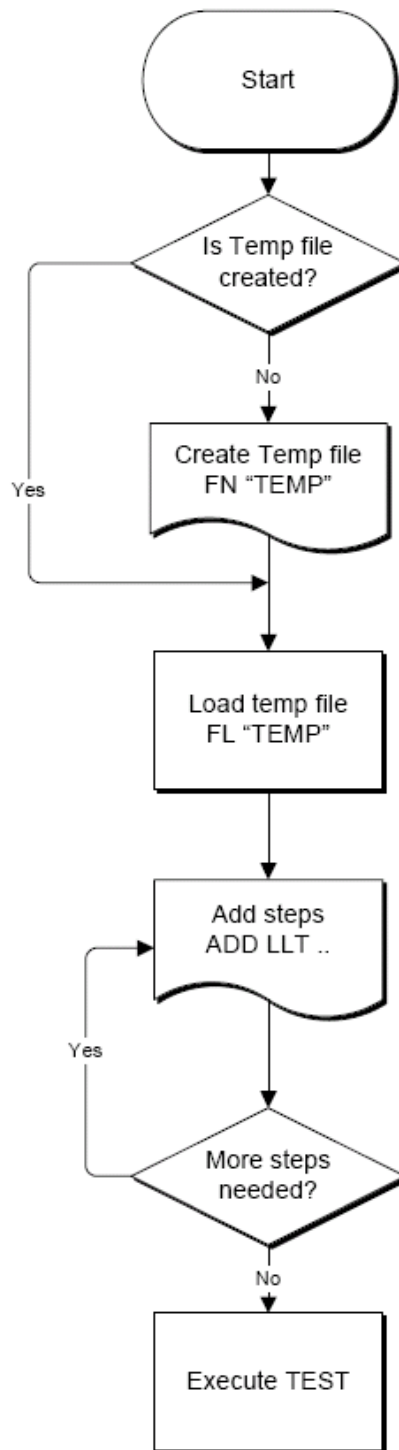

FOR MORE INFORMATION ON IEEE (GPIB) PLEASE CONTACT

The Institute of Electrical and Electronic Engineers, Inc.
345 East 47th Street,
New York, NY 10017
☎ 1-212-705-7018 (Communications Society of IEEE)
Internet: www.ieee.org

8. OPTIONS

Introduction

This section contains a list and descriptions of available factory installed options at the time of this printing. The list of options contains an option code number that can be referenced on the data plate on the rear panel of the unit.

Option Label

On the rear panel of the instrument, you will find a label that contains the option code.

For example, your options code would appear as follows:

Fitted with option 01..... OPT: 01
 Fitted with option 01 and 05..... OPT: 0105

Option List

CODE	DESCRIPTION
01	Internal Scanner
03	Dual Remote Test Switches
04	OMNIA to APT 3 Memory (Discontinued)
05	OMNIA to APT 7 Memory
06	Cold Resistance
07	Data Storage Card (Discontinued)
08	Printer Port
09	Ethernet Card
10	GPIB Card
11	DUT Output Relay Controls (8206 Only)
14	400/800 Hz Hipot Output (8206 Only)
15	3mA AC/DC Output (Discontinued)
16	Prompt Interlock
17	GB Volt (Discontinued)
51	PLC Voltage Control (Discontinued)
52	15 Remote Memories Select (Discontinued)
54	Reactive Current (Discontinued)
55	31 Remote Memories Select (Discontinued)
56	Power Tracking (8206 Only)
57	Hardware Interlock
58	Disable RUN/LLT GFI

01 8 Channel Scanner

The Scanner option provides 8 high Voltage/Continuity channels and 8 Ground Bond/Continuity channels on the rear panel. The High Voltage/Continuity channels can be set to a High or Low level, giving the capability to test from one

channel to another channel or from any channel to a common Low or Return point. The channels can be connected in parallel if desired but there is only one leakage current measurement for all channels.

The Ground Bond/Continuity channels can only be used to test from one channel to the common Return. Only one channel may be used for each Ground Bond or Continuity test. The Ground Bond or Continuity test will be performed between the output channel selected and the Ground Bond/Continuity common terminal.

Although the G-COM terminal is isolated from the Return terminal during a Hipot or IR test, the Ground Bond/Continuity channels can be referenced directly to the Return lead without using the G-COM terminal during a Ground Bond or Continuity test.

True 4-wire measurement through the Scanner is not possible because of the Kelvin lead termination, but the Milliohm-Offset feature should be used to reduce measurement errors. The Return lead Kelvin connection is terminated at the alligator clip of the test lead, but the G-COM terminal has an internal Kelvin connection that shorts out the test lead Kelvin connection. Therefore, the resistance of the Return test lead will be measured during the test unless the Milliohm-Offset feature is used.

The Scanner will provide output to multiple test points and will have the same operation specifications that apply to the standard instrument with the exception of one Ground Bond/Continuity channel limitation: due to the characteristics of general-purpose High Current relays, some additional contact resistance cannot be prevented. Although this contact resistance can be offset using the Milliohm-Offset feature of the instrument, there will be some variation in the contact resistance because the relay must open and close. Each relay closure may represent a different resistance value. The Ground Bond channels will have the following characteristics:

GROUND BOND/CONTINUITY CHANNEL RESISTANCE DEVIATION	
Deviation (Relay Contact)	Test Current
6mΩ maximum	≥10A

03 Dual Remote Test Switches

The Dual Remote Test Switch option allows the user to configure dual palm switches for safe production line operation.

To activate the option, you must access the Setup System Menu from the Main Menu screen. This process is described in section **4.2. Setup System Menu** in this manual. Once at the Setup System screen press the “Hardware” soft key.

Using the available soft keys set the PLC Remote to **ON** and Dual Test to **ON**.

The rear panel remote interface is reconfigured to allow two test switches instead of the standard reset and test inputs. The two test switches have to be pressed within 0.5 seconds to activate the test process. The two test switches must remain closed to continue the test. If either of the test switches is released, the process will be shut down immediately. The functions of the Test and Reset switches on the front panel will be disabled if the dual test switches are enabled. When the Dual Test parameter is turned OFF, the Test and Reset switches on the front and rear panel behave the same as the standard instrument, and are controlled by the PLC Remote On/Off selection.

04 Omnia to APT 3 Memory (Models 8206, 8207, 8256, 8257) (Discontinued)

With this option installed, the PLC remote signal output has been reconfigured to provide a 2-Bit digital control signal that is menu selectable from the Run Test or LCT parameter screen. In this configuration, the PLC remote signal output may be used to control a compatible Associated Power Technologies (APT) AC power source.

This option is provided with a cable which is designed to interconnect the OMNIA II PLC output to the APT power source Remote I/O input. This cable, part number 38774, is custom and can only be purchased from Associated Research.

When using this option with an APT power source, be sure to power up the OMNIA II first and then power up the AC power source. When powering down the instruments, power down the AC power source first and then power down the OMNIA II. The OMNIA II is in an undetermined state without power and may cause inadvertent memory activation of the APT power source. If you would like to operate the APT power source independently of the OMNIA II, either disconnect the interface cable or disable the PLC remote on the APT power source.

The Remote Memories send signals are provided by two normally open internal relays. These are normally open free contacts and will not provide any voltage or current. The ratings of the contacts are 1A / 125 VAC (0.5ADC).

With this option, a new soft key selection will appear on the Run Test parameter or LCT parameter screen. In the LCT parameter screen it will be necessary for you to press the “More” soft key to access the PLC control parameter. The new soft key, called PLC Control will toggle between M1, M2, and M3 when pressed.

Setting the PLC control selection to M1, M2, and M3 will create different digital states at Bit 0 and Bit 1 of the PLC Remote Signal Output (refer to the PLC Signal Output drawing below). The different states are described in the truth table below. The “Not used” state is undefined and cannot be programmed for use.

SIGNAL OUTPUT

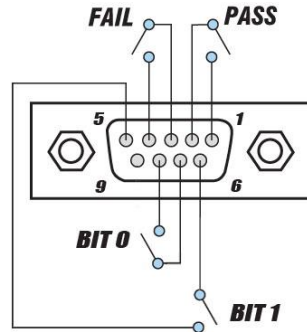

BIT 1	BIT 0	TEST VOLTAGE SETTING
0	0	Not used
0	1	M1
1	0	M2
1	1	M3
0 = OPEN		1 = CLOSED

Because the relay that normally provides the processing signal has been reconfigured for voltage control, the Fail and Pass signals have been reconfigured to provide Pass, Fail, and Processing signals. The different states of the Fail and Pass signals are described in the truth table below.

FAIL	PASS	CONDITION
0	0	After RESET is pressed
0	1	Pass
1	0	Fail
1	1	Processing
0 = OPEN		1 = CLOSED

For questions related to the standard configuration of the PLC remote, please refer to section **6. Connection of Remote I/O**.

The following Test Parameter Editing GPIB commands may be used to control the memory send selection.

COMMAND	NAME	TEST TYPES	VALUE
EPM n, n=1-3 EPM?	Edit PLC Memory Send	RUN LCT	1=M1, 2= M2, 3=M3

The ADD command can also be used. The memory selection should be inserted as the last parameter and should use full text as indicated on the LCD screen such as M1 or M2.

05 Omnia to APT 7 Memory (Models 8206, 8207, 8256, 8257)

This option provides a dedicated signal output connector that is added to the rear panel of the LCT card. The new signal output connector can be used to control a compatible device such as an Associated Power Technologies (APT) AC power source. The output is a 3-bit digital control signal that is menu selectable at the Run Test or LCT parameter screen.

This option is provided with a cable which is designed to interconnect the OMNIA II LCT card 9-pin output to the APT power source Remote I/O input. This cable, part number 38772, is a standard 9-pin female to 9-pin male.

When using this option with an APT power source, be sure to power up the OMNIA II first and then power up the APT power source. When powering down the instruments, power down the APT power source first and then power down the OMNIA II. The OMNIA II is in an undetermined state without power and may cause inadvertent memory activation of the APT power source. If you would like to operate the APT power source independently of the OMNIA II, either disconnect the interface cable or disable the PLC remote on the APT power source.

The Remote Memories send signals are provided by three high voltage, high current Darlington drivers. These are open collector devices capable of sinking 350mA at voltages as high as 95 VDC.

With this option installed, a new soft key selection will appear on the Run Test or LCT parameter screen. In the LCT parameter screen it will be necessary for you to press the “More” soft key to access the PLC control parameter. The new soft key, called PLC Control will toggle between M1 through M7 when pressed.

Setting the PLC Control selection to M1 through M7 will create different digital states at Bit 0, Bit 1, and Bit 2 of the PLC Remote Signal Output (refer to the PLC Signal Output drawing below). The different states are described in the truth table below. The “Not used” state is undefined and cannot be programmed for use. A Reset Out signal is also available to allow the user to be able to reset the APT source during or at the end of a test. The Reset Out signal will not be sent automatically to the APT source. Either the Reset button on the Omnia 2 will need to be pressed or a Bus Reset command will need to be sent to the Omnia 2 for it to be able to send a Reset Out signal to the APT source.

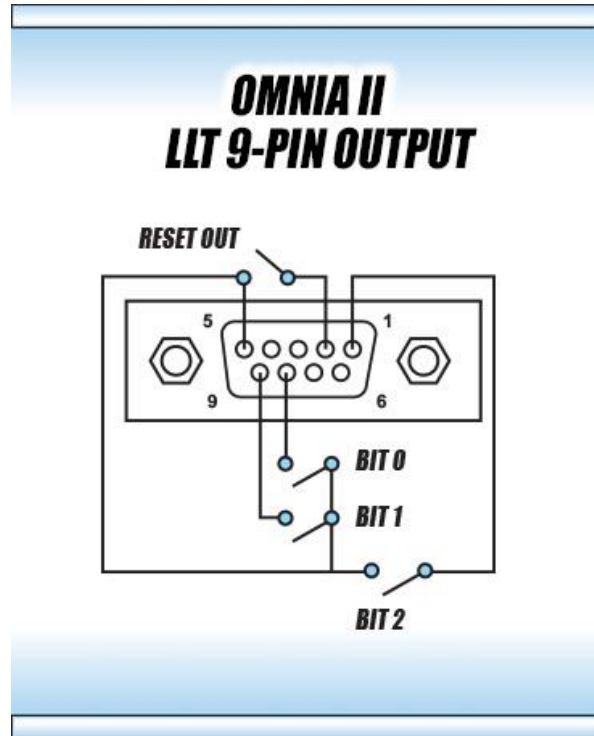

BIT 2	BIT 1	BIT 0	TEST VOLTAGE SETTING
0	0	0	Not used
0	0	1	M1
0	1	0	M2
0	1	1	M3
1	0	0	M4
1	0	1	M5
1	1	0	M6
1	1	1	M7
0 = OPEN 1 = CLOSED			

The following Test Parameter Editing GPIB commands may be used to control the memory send selection.

COMMAND	NAME	TEST TYPES	VALUE
EPM n, n=1-7 EPM?	Edit PLC Memory Send	RUN LCT	1=M1, 2= M2, 3=M3, 4=M4, 5=M5, 6=M6, 7=M7

The ADD command can also be used. The memory selection should be inserted

as the last parameter and should use full text as indicated on the LCD screen such as M1 or M2.

06 Cold Resistance (Models 8206, 8207, 8256, 8257)

This option provides the added ability to measure resistance at the Line and Neutral connectors on the LCT card.

With this option installed, a new soft key selection will appear on the Continuity parameter screen called “Continuity”. Please refer to the screen below:

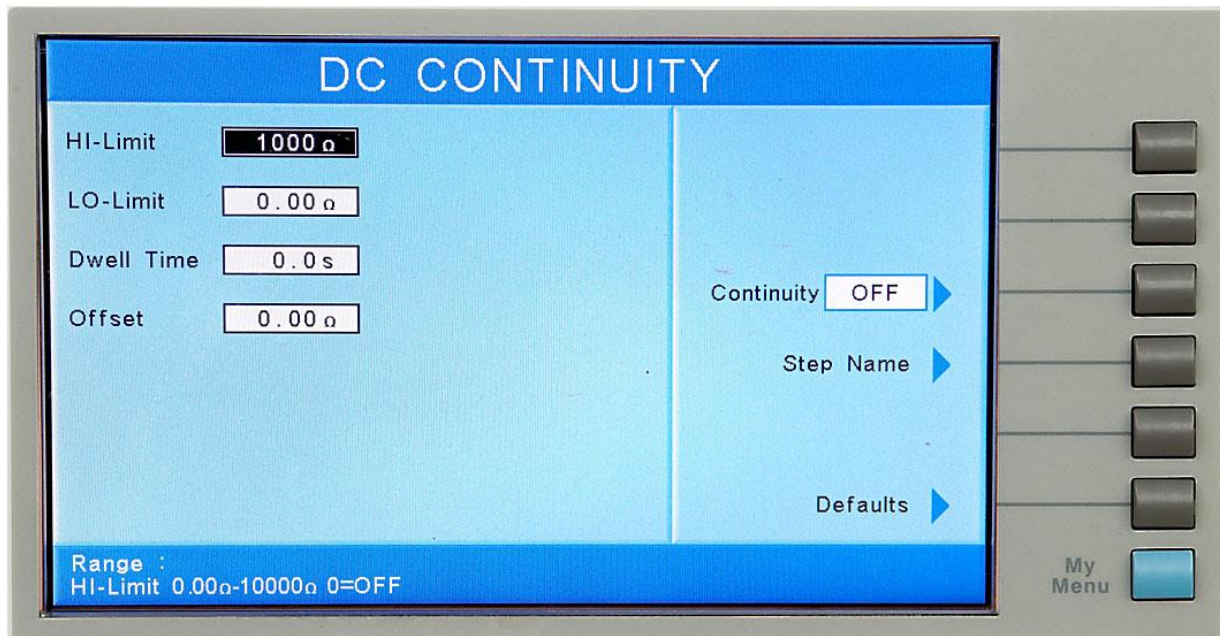

The “Continuity” selection is short for continuity connection and refers to which connection points may be utilized for the continuity measurement. The new continuity parameter has three toggle selections MAINS, GND, and OFF.

When MAINS is selected, continuity may be measured from the L and N connections of the LCT card or from the front or rear panel current and return. Do not use the front and rear panel connections at the same time as the L and N connections as this will affect the continuity reading.

When GND is selected, continuity may be measured from the LCT card’s GND and Case connections or from the front or rear panel current and return connections. Do not use the front or rear panel connections at the same time as GND and CASE connections as this will affect the continuity reading.

When OFF is selected you may only use the front or rear panel current and return connections to connect the continuity DUT. Use the OFF selection when using the OMNIA II with an external scanner, as this will provide isolation

between the LCT card and external scanner connections.

As a safety precaution, Cold Resistance testing is not allowed directly after a RUN or LCT test. If you setup a Continuity test directly after a Run or LCT test the MAINS parameter will not be available. If you attempt to insert a Run or LCT test before a Cold Resistance test, the instrument will give an error beep and not allow the insertion of the test step. Not allowing Cold Resistance testing directly after a RUN or LCT test prevents any residual DUT voltage from possibly damaging the instrument.

The following Test Parameter Editing GPIB commands may be used to control the new toggle parameter.

COMMAND	NAME	TEST TYPES	VALUE
ECR n, n=0-2 ECR?	Edit Cold Resistance Connection	RUN LCT	0= GND, 1= OFF, 2=MAINS

The ADD command can also be used. The memory selection should be inserted as the last parameter and should use full text as indicated on the LCD screen such as M1 or M2.

The specifications for the 10k continuity remain the same with this option installed.

07 Data Storage Card (Discontinued)

This option gives the user capabilities for serial communication, barcode scanning, and saving test results onto a USB Flash memory drive.

The Data Storage Card has three input/output ports. These ports are shown in Figure 3.



BO

Figure 3

The USB-A port is used for the connection of the USB Flash memory drive.

Note: Please use the USB Flash memory drive that was supplied with the unit. Proper file transfer can only be guaranteed with the use of this drive. The

port labeled “Barcode” is a PS/2-type connector that is used for the connection of a barcode scanner. The 9-pin D-type subminiature connector labeled “RS232/RS485” is for the connection of the OMNIA II to an RS232 or RS485 communication bus. To configure all of the features of the Data Storage Card, use the Data Card Settings menu.

To navigate to the Data Card Settings menu, select the Setup System soft key from the OMNIA II Main Menu and then select the Data Card Settings soft key in the Setup System menu. A brief description of the settings follows:

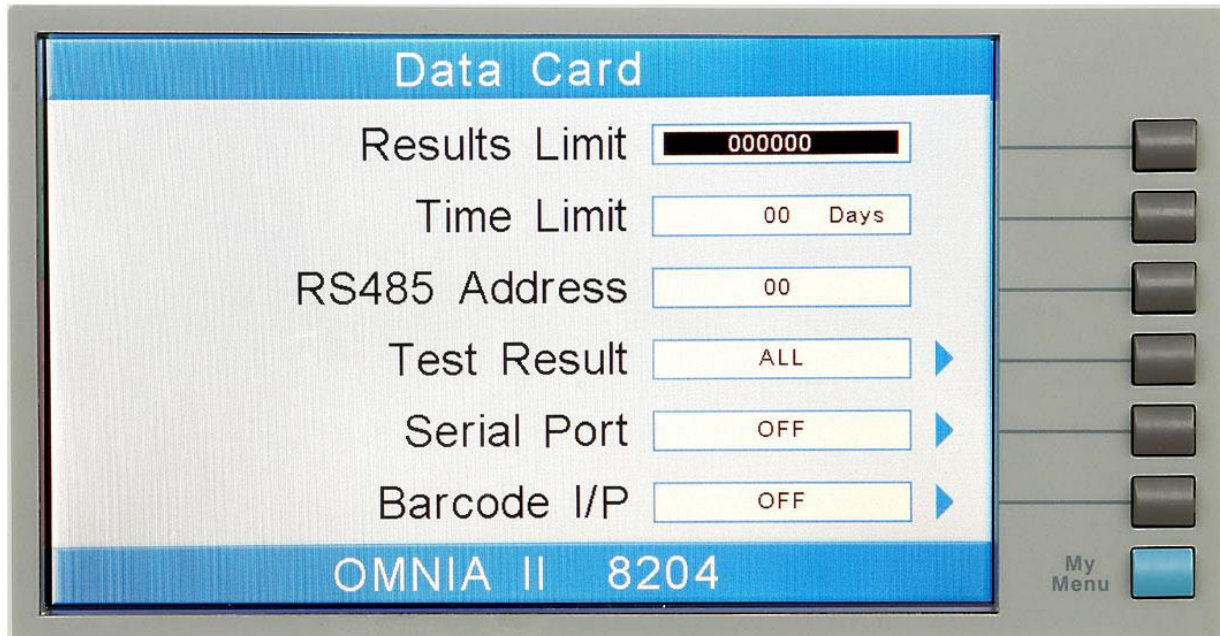

Results Limit

The Results Limit allows the user to receive an alert message on the display of the OMNIA II when the total number of results saved on the Data Storage Card’s internal Flash memory has exceeded the predefined limit. This value can be set from the default value of “0” (disables the function) to 100,000. At the conclusion of a test file, if the total results on the internal Flash memory exceed the Results Limit, the following message will display:



The message gives two options: Pressing Enter will clear the message and display it again at the end of the next test file execution. Pressing Exit will clear the message and not display it again unless the unit is re-booted, or the user deletes all previous results and the total results are exceeded once more.

Time Limit

The Results Limit allows the user to receive an alert message on the display of the OMNIA II when any of the results saved on the Data Storage Card's internal Flash memory are older than the predefined setting. The Time Limit can be set to its default value of "0 days" (function is disabled) to 99 days. When the Time Limit is exceeded the following message will appear on the OMNIA II's display:

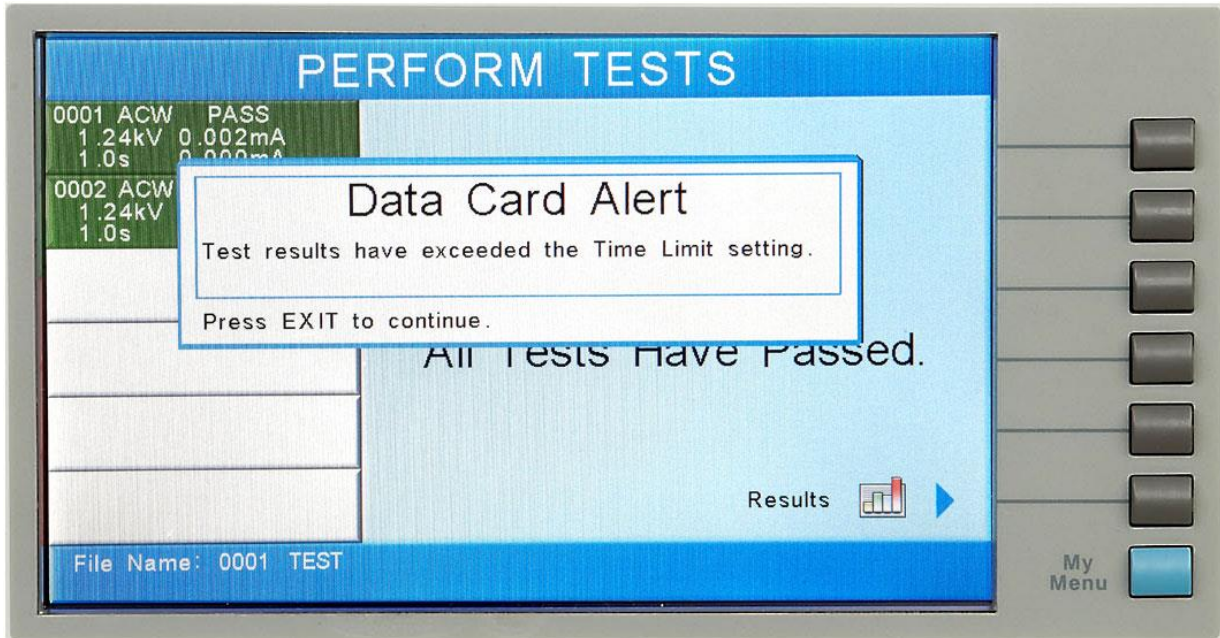

By pressing the EXIT soft key, the message will be cleared and it won't appear again until the unit is re-booted or the Time Limit setting is set to a different value.

RS485 Address

This setting specifies the RS485 address of the Data Storage Card if the user intends to use the unit in an RS485 network. This address can be set from 1-99. For more information on this interface, see the Serial Port description below.

Test Result

The Test Result setting determines which type of test result is automatically saved to the Data Storage Card. The possible settings are Pass, Fail, All or None. If the Test Result setting is set to Pass, the Data Storage Card will only save results that resulted in a Pass. If the Test Result setting is set to Fail, the Data Storage Card will only save results that resulted in a Fail. Setting the Test Result setting to All will have the Data Storage Card record all results (pass or fail). If the Test Result setting is set to None, no test result (pass or fail) will be saved to the Data Storage Card's internal memory.

Serial Port

The serial port can be set to RS232, RS485, or OFF.

RS232 Interface

When selecting RS232, the protocol for interfacing and communicating with a PC can be found in section 7. of this manual.

RS485 Interface

The RS485 interface of the Data Storage Card is designed to function on a two-wire (half-duplex) RS485 network, i.e. data is received and transmitted differentially on the same pair of wires. The RS485 cabling should be configured as shown:

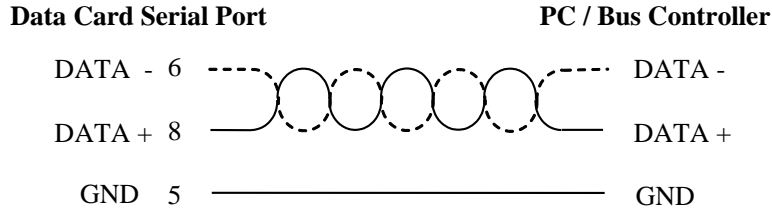

The wire used to connect the DATA signals from the Data Storage Card to the RS-485 network should be twisted pair.

Before sending a command to the RS485 enabled Data Storage Card, the unit that the command is intended for needs to be addressed. To send the address, the following format is used:

X <RS485 Address><line feed>

Note that there should be a character space between “X” and the RS485 address. After addressing the unit, the command can be sent. The instrument that was last addressed will receive all subsequent commands sent on the data bus. If the RS485 address specified is “0”, then all RS485 instruments on the bus will receive the command. The command set used for RS485 is the same as the command set for RS232.

When using the RS485 bus and sending the “0” address, the instruments will not respond with the Acknowledge (06H or 6 decimal) or Not Acknowledge (15H or 21 decimal) strings after a command is sent, and will not respond to any Query Commands.

It is also possible to combine the RS485 address and the desired instrument command all in the same string using the following format:

X <RS485 Address>;<Command><line feed>

Important note: When communicating with the OMNIA using the RS485/RS232 port, results are not saved to the Data Storage Card.

Barcode Input

The Barcode Input setting can be set to SERIAL#, PRODUCT#, SER/PROD, OFF and RUN FILE. When the setting is SERIAL#, PRODUCT# or SER/PROD the user can scan barcodes in the Perform Tests screen before the test is started. When the barcode is scanned, one of the following messages will

appear on the display.

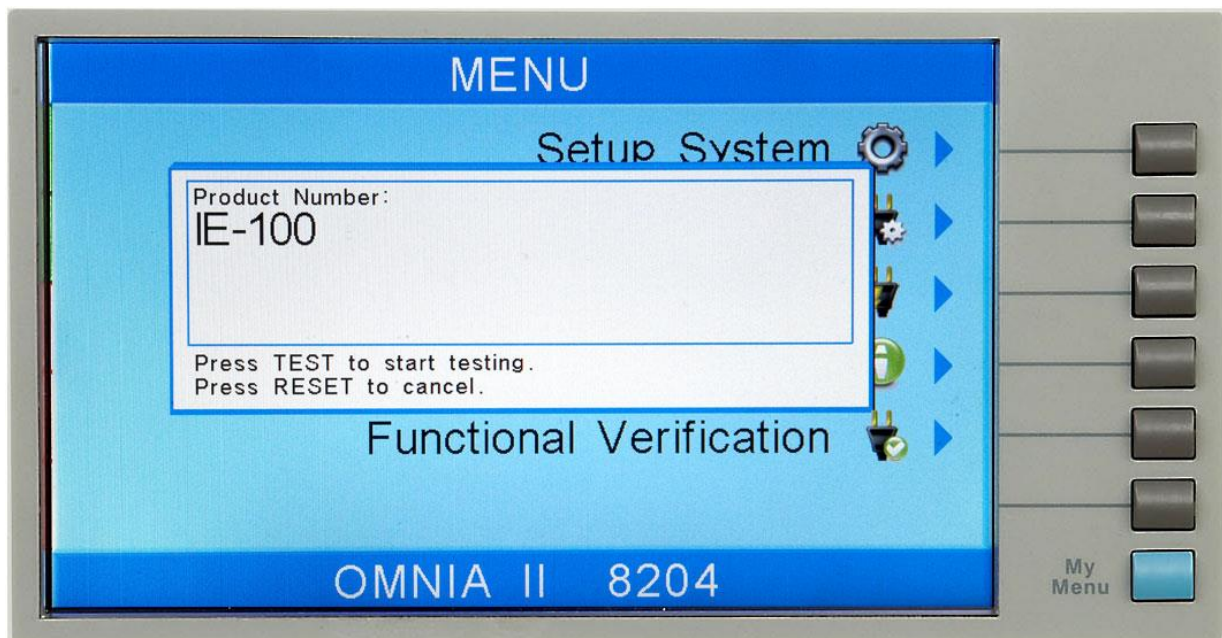
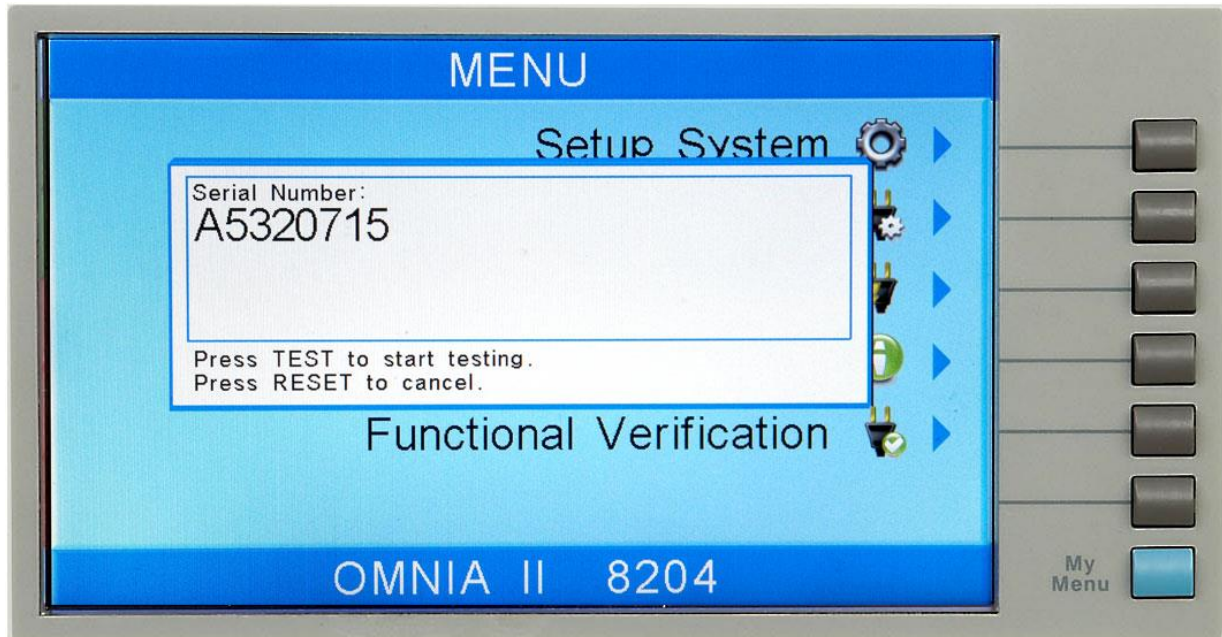

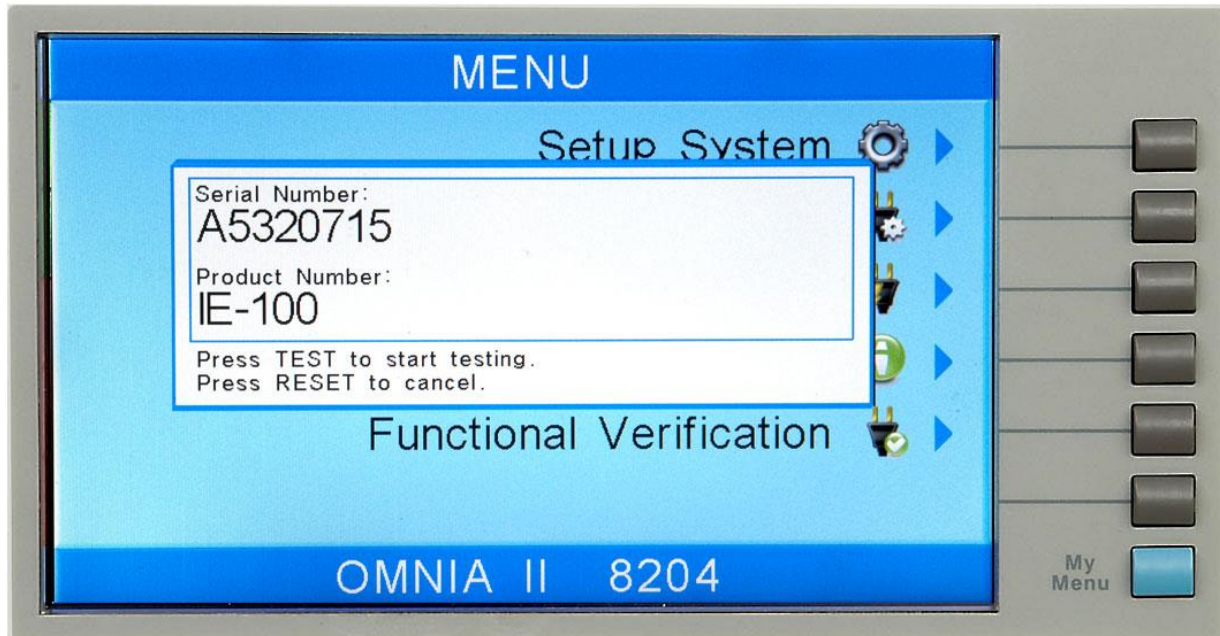

After the barcodes are scanned, pressing TEST will initiate the test sequence. Pressing RESET will abort the TEST sequence.

The Data Storage Card allows for the re-scanning of barcodes if the previously scanned barcode was incorrect. Re-scanning is available in the SERIAL#, PRODUCT# and SER/PROD modes. Anytime before a test is initiated, the user can re-scan a barcode. If the user decides to re-scan barcodes when the Barcode I/P setting is set to SER/PROD, the Data Storage Card will first replace the data in the Serial Number field, and if the user re-scans another barcode, the Data Storage Card will replace the data in the Product Number field.

The RUN FILE selection gives the user the ability to automatically load and execute a test file based on what barcode is scanned from the Perform Tests screen.

WARNING

Using the RUN FILE feature will enable the instrument's output once the barcode is scanned. Do not touch the DUT at any time when using this feature in order to avoid potential shock or serious injury.

To completely enable this feature, the user must name the desired test file for a particular product the exact alpha-numeric code that is on the product's barcode label. For example, if Product A has barcode "123456789", then the test file that the user would like to run when testing Product A should be named "123456789". Upon scanning the barcode, the OMNIA II will immediately execute the test associated with that barcode. The test file name is limited to 10 characters. However, if the user names a test file with the maximum 10 characters, this

function will still initiate a test when a product's barcode begins with those first 10 characters even if the barcode has more than 10 characters.

When using certain features of barcoding, the OMNIA II's response to the TD? and RD x? commands will differ slightly to an OMNIA II with the standard RS232 interface. For all types of tests (ACW, DCW, IR, GND, CONT, LCT, RUN) two fields are added to the end of the standard response when the Barcode I/P setting is set to SERIAL#, PRODUCT# or SER/PROD. The first field contains the Serial Number information and the second field includes the Product Number information. Both fields are included regardless of which of these three modes are selected. The Data Storage Card will simply substitute a "0" for the field if it is not applicable to the setting. For example, if a user had their Barcode I/P setting set to SERIAL#, and scanned a Serial Number with the value "123456789", the TD? response for an ACW test could be:

```
01,ACW,Pass,1.24,1.000,0.900,1.0,123456789,0
```

Note that there is a "0" in the Product Number field because the Barcode I/P setting is SERIAL#.

When the Barcode I/P setting is RUN FILE or OFF, these fields are not included in the TD? and RD x? responses.

Operation

The Data Storage Card Results menu can be viewed by pressing the Results soft key while in the Perform Tests Screen. After doing so the following menu will be shown:

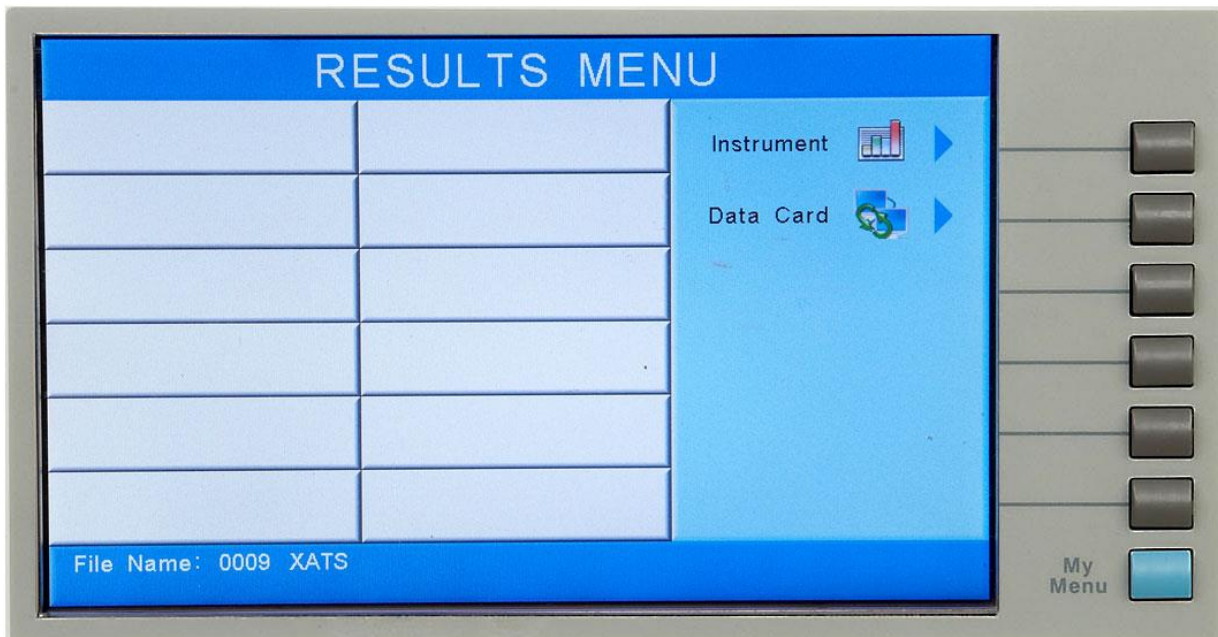

Pressing the soft key labeled Instrument will display the detailed results from the previously executed test file. Pressing the soft key labeled Data Card will display

the Data Storage Card Results menu as shown below:

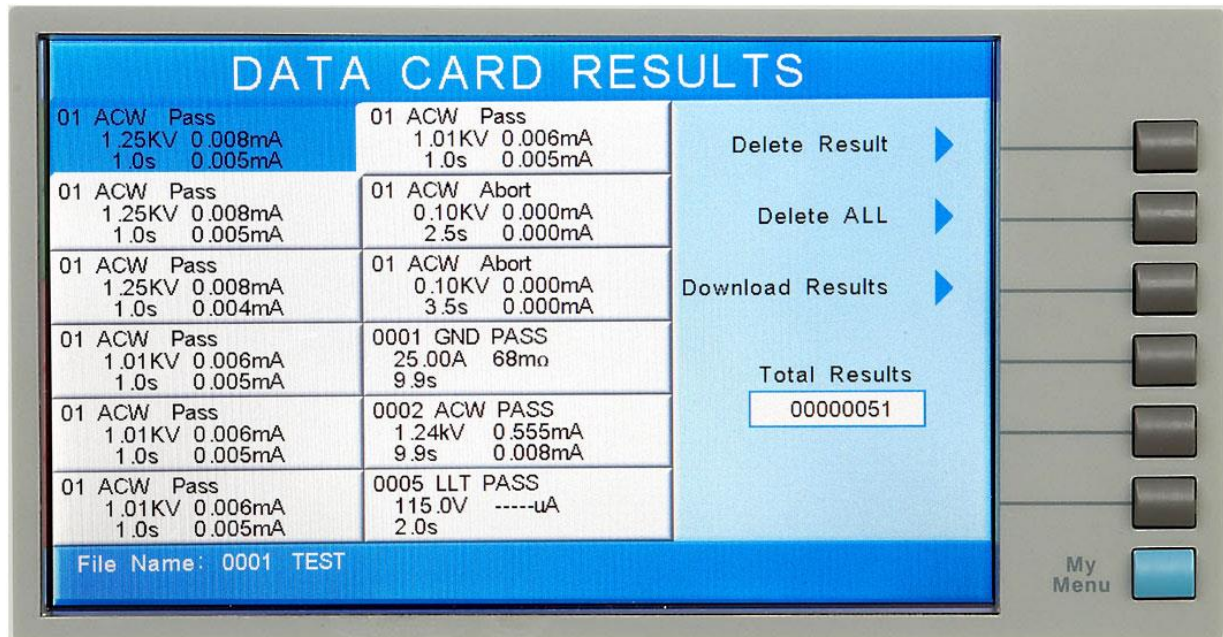

From this menu, the user can view the stored results, delete results, and transfer the results to the external USB Flash memory drive. To navigate through the results use the up, down, left and right soft keys on the OMNIA II front panel. The following message will display if the Delete Result soft key is pressed:

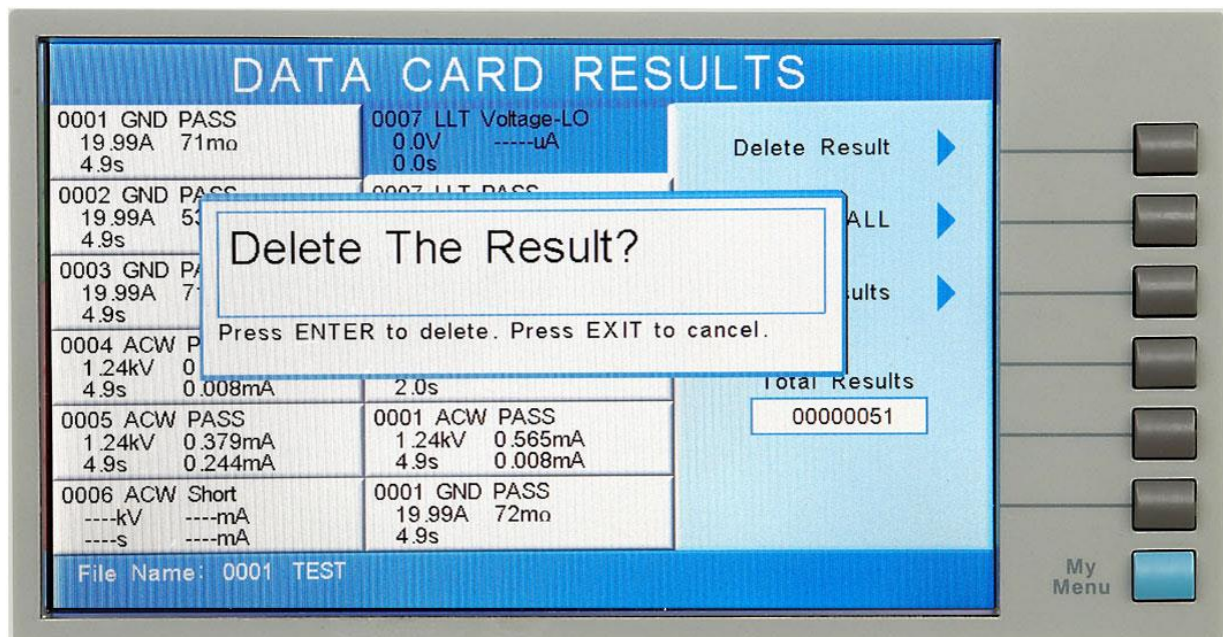

Pressing Enter will verify that the user wants to delete all of the results on the Data Storage Card, and pressing Exit will cancel deleting the results.

The following message will appear if the Delete ALL soft key is pressed:

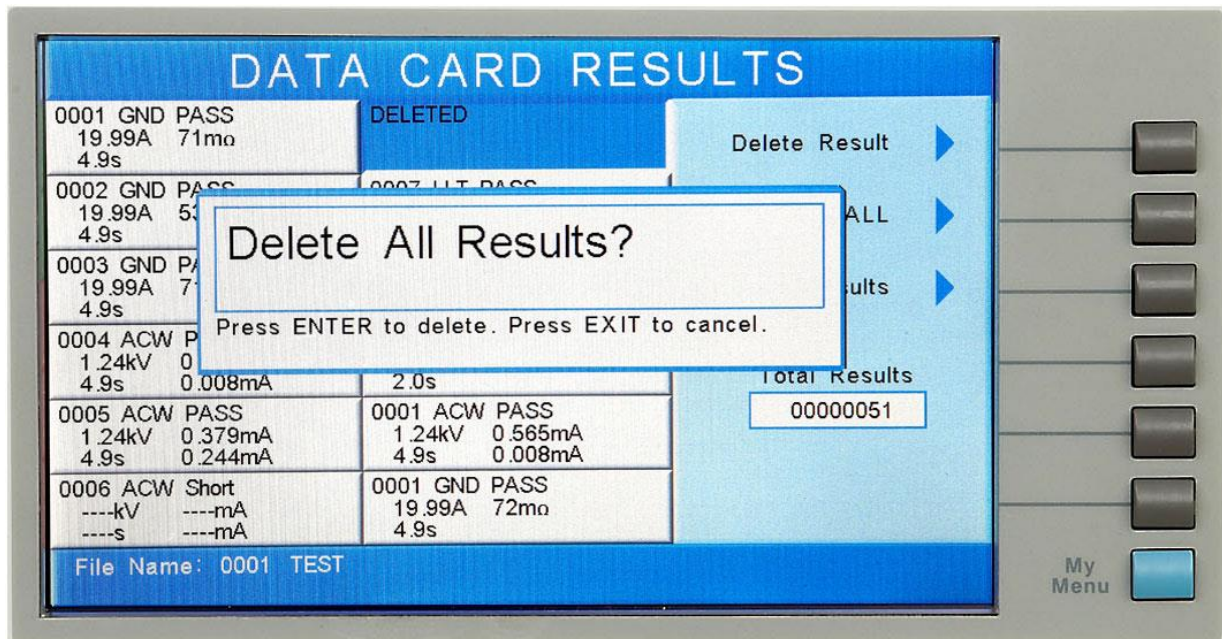

The following menu will appear if the Transfer Results soft key is pressed:



Follow the instructions on the screen in order to create a name for the file you wish to transfer. There is a limit of 8 characters for the name of the results file. Press the Enter soft key when you have finished entering the file name. After pressing Enter, you will see the following message:

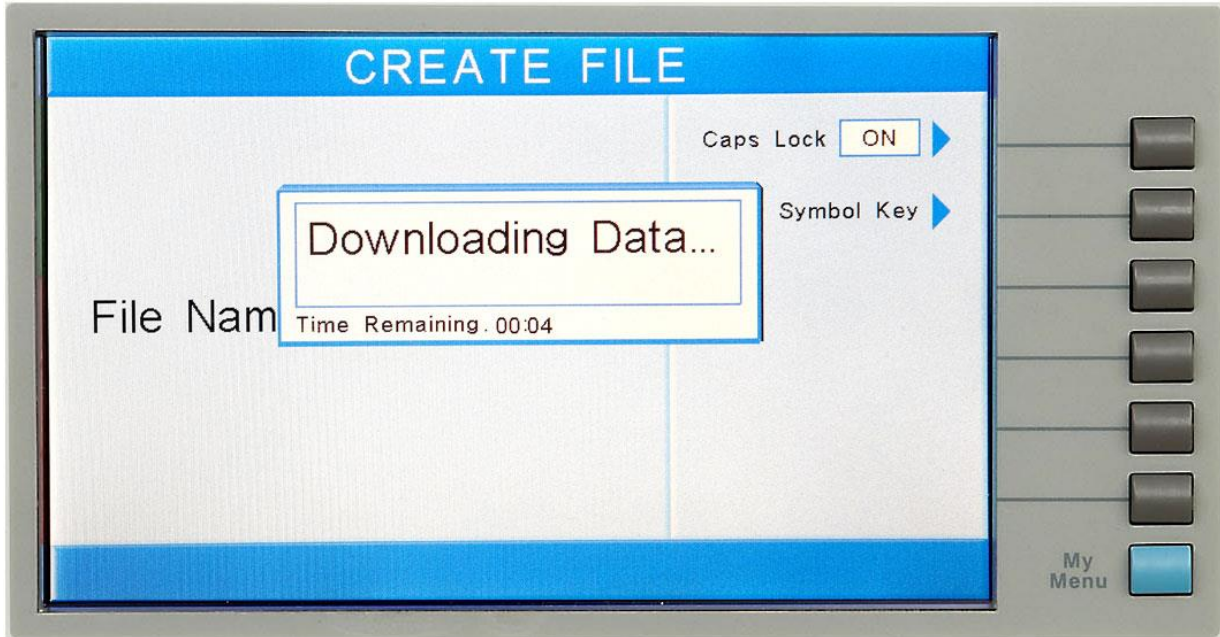

This message will appear on the screen until the Time Remaining reaches 00:00. For each transfer, the Data Storage Card will copy all results in the internal Flash memory regardless if some or all of the results have been transferred before. During each transfer, the Data Storage Card will create a .txt file that will contain the information for all of the results. To view this .txt file, remove the USB Flash memory disk from the Data Storage Card and connect it to a PC with a USB port.

Contents of Results File

The following is an example entry in the Data Storage Card results file for an arbitrary ACW test:

```
00000001,06/14/06,08:26,TEST1,8106,0120013,M01,S01,ACW,Pass,1.24KV,0.004mA,0.000mA,1.0s
```

The following table gives a description of each field for the above ACW test.

FIELD CONTENTS	DESCRIPTION
00000001	Test Entry in Results File
06/14/06	Date of Test
08:26	Time of Test
TEST1	Test File Name
8206	Model Number of Testing Unit
0120013	Serial Number of Testing Unit
M01	Memory Number of Test File
S01	Step Number

FIELD CONTENTS	DESCRIPTION
ACW	Test Type
Pass	Test Result
1.24KV	Test Voltage
0.004mA	DUT Leakage Current (Total)
0.000mA	DUT Leakage Current (Real)
1.0s	Test Dwell Time

The first ten fields of the test result shown above are included in each test result regardless of the test type. The remaining entries are specific to each test type. The following table shows, in order, the information that will be included in each test type's result entry.

DCW	IR	CONT	GND	RUN	LCT
Test Voltage	Test Voltage	DUT Resistance	Test Current	DUT Voltage	DUT Voltage
DUT Leakage Current	DUT Resistance	Test Dwell Time	DUT Resistance	DUT Current	DUT Leakage Current
Test Dwell Time	Test Delay Time		Test Dwell Time	DUT Power	Test Delay Time
				Test Dwell Time	
				DUT Leakage Current	
				DUT Power Factor	

- **NOTE:** If barcoding is used, the barcoding information will be the final entries in the results file with Serial Number being first and Product Number being second.

Other Displayed Messages



The above message occurs when the user attempts to transfer results from the Data Storage Card onto the USB Flash memory drive, but there is not enough empty space on the drive to save the file. To save the results file, the user needs to create some empty space on the USB Flash memory drive.

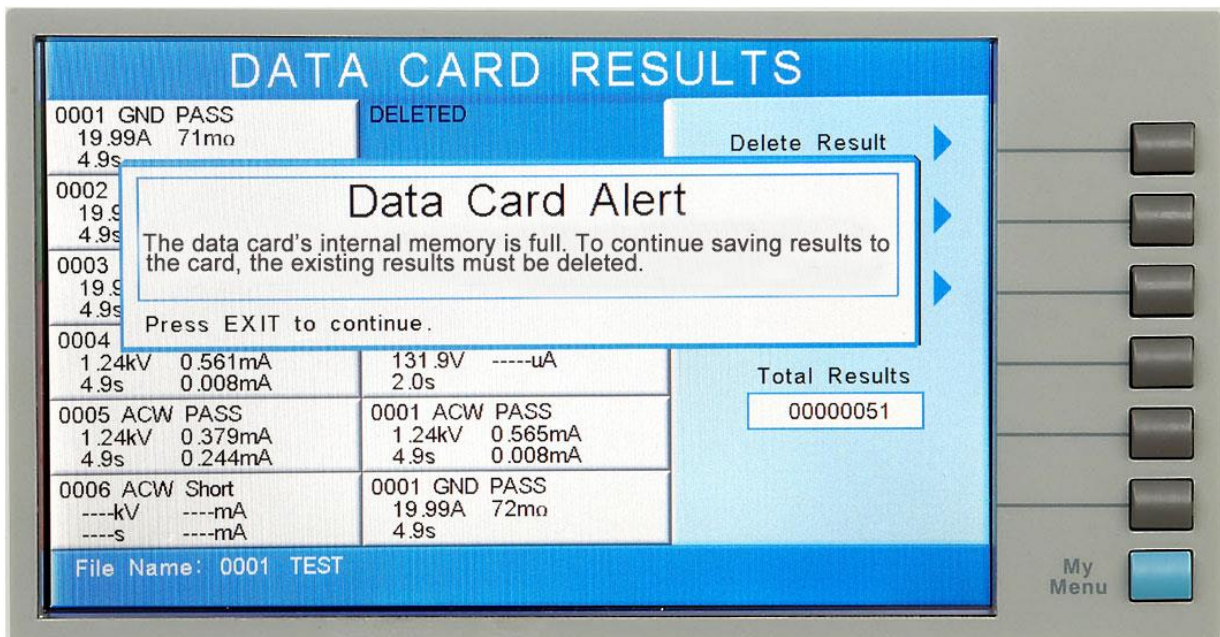

The above message occurs when the total results accumulated on the Data Storage Card exceeds 100,000. The OMNIA II will not allow any more tests to be run unless the user deletes the results currently on the Data Storage Card or

changes the Test Result setting in the Data Card Settings menu to NONE. If the Test Result setting is set to NONE, the Data Storage Card will not record test results.

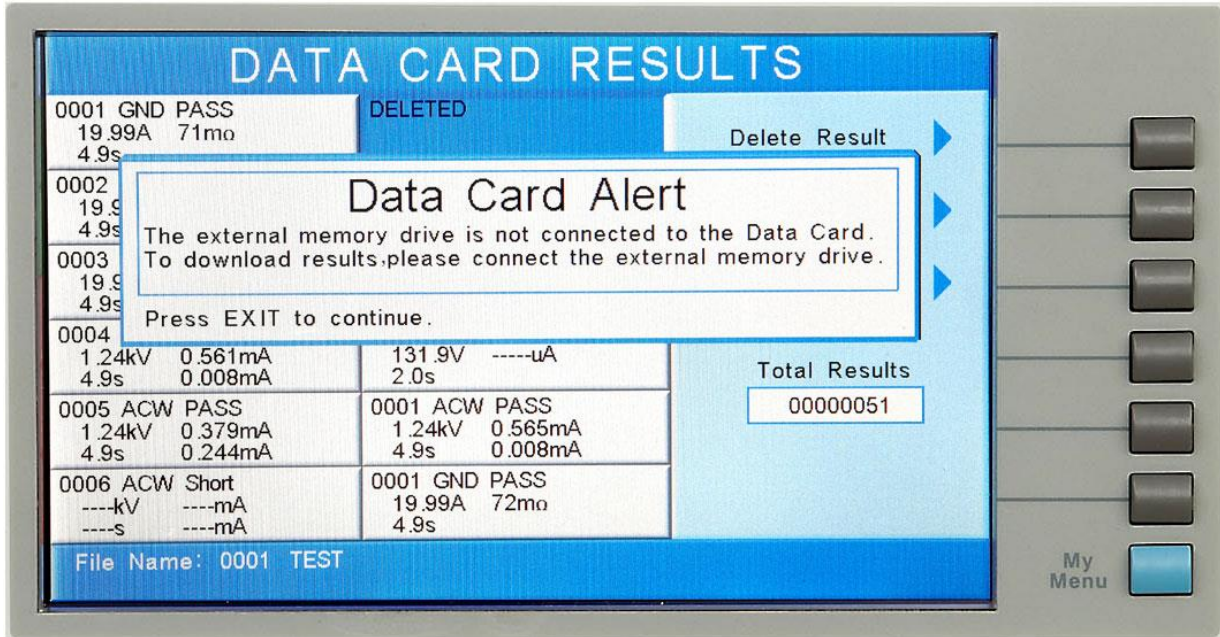

The above message occurs when the user tries to transfer results from the Data Storage Card without the USB Flash memory drive connected. To transfer results, the user needs to have the Flash memory drive connected to the Data Storage Card.

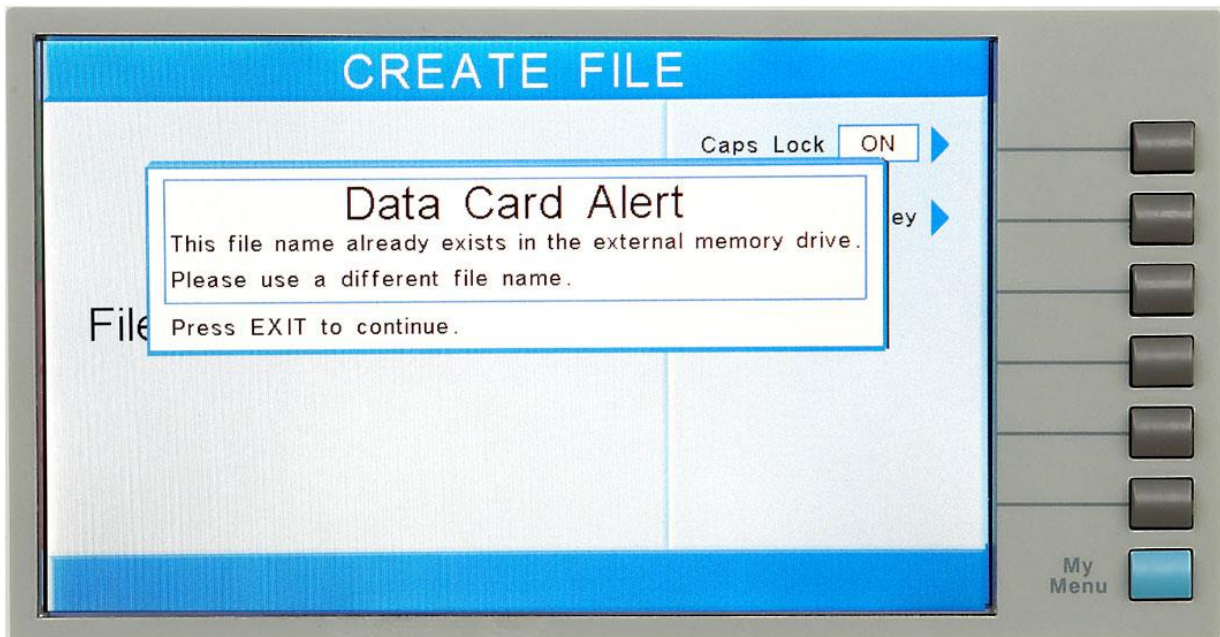

The above message appears when the user attempts to give a name to a results

file that already exists on the Data Storage Card.

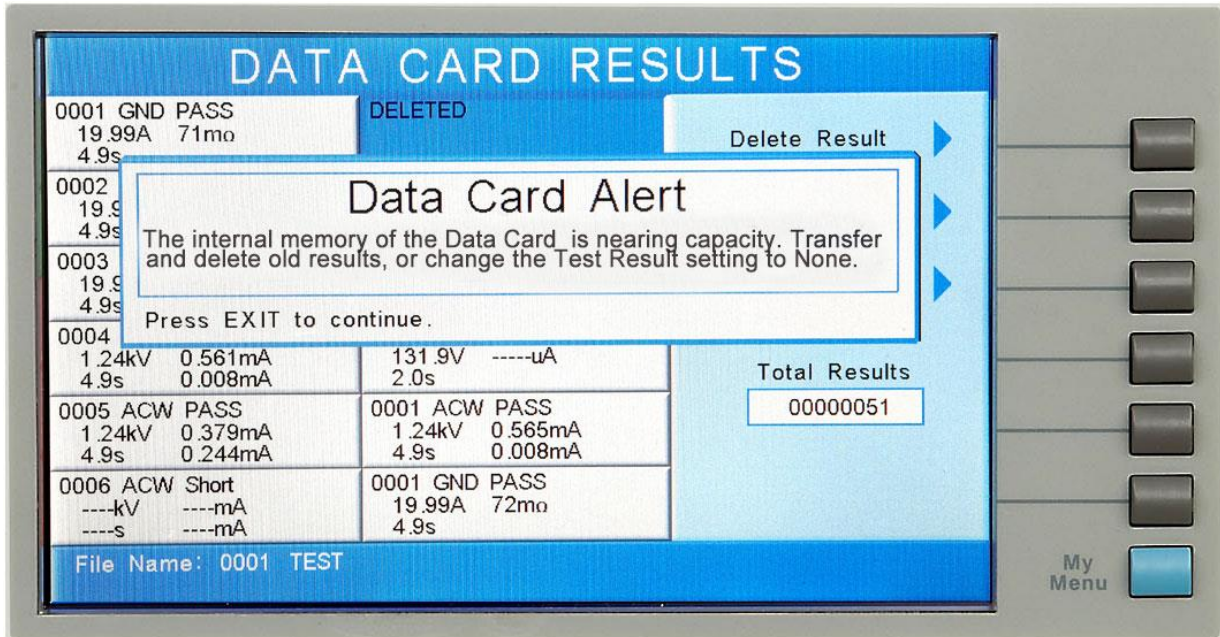

The above message appears when the total results accumulated by the Data Storage Card exceeds 99,900. This is a warning to the user that the total results are nearing the capacity of the Data Storage Card (100,000). When the total results on the Data Storage Card exceed 100,000, the Data Storage Card will cease saving results. To avoid this, the user can transfer and delete the old test results, or change the Test Result setting in the Data Card Settings menu to NONE. When the Test Result setting is set to NONE, the Data Storage Card will not record test results.



The above message appears when the USB Flash memory drive is write-protected. There are two ways to configure the memory drive as write-protected. One is to set the switch on the side of the memory drive up (towards the drive's connector). The other is to configure it through the drive's properties in Windows.

08 Printer Port

This option allows the instrument to generate hardcopy printout of the test results. The printout can be configured to print automatically with each test, or manually by pressing a front panel key. There is also capability to enter a device ID number to each test, that increments automatically after each test is performed. The test can be further configured to print only results from tests that have failed or to print all test results from every test performed.

The Printer Port is a USB interface and should be compatible with most USB printers. The printer port output uses simple ASCII characters and control codes. Simply connect the printer to the OMNIA II and configure the printer output using the Setup Systems menu. From the System Setup screen, press the "Print Format" soft key. The Print Format setting screen will now be displayed. From the Print Format setting screen, six different parameters may be accessed; Device ID number, Mode, Test Result, Test Setting, Device ID, and Form Feed. The Print Format setting screen will appear as follows:

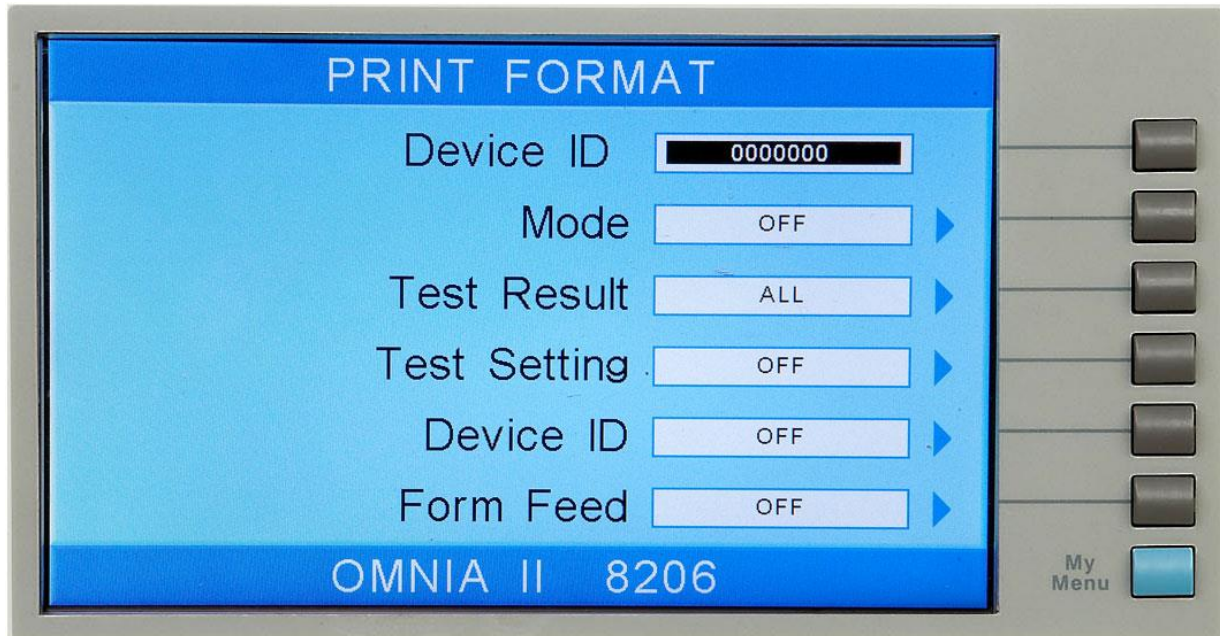

Mode

From the Print Format setting screen, press the “Mode” soft key. As the soft key is pressed, the mode will change between three available print modes Auto, Manual and OFF.

In the Auto mode, the OMNIA II will automatically send the test results to the printer at the end of every complete test. The Enter key may also be used from the end of test summary screen or the results screen to create additional printouts as needed.

In the manual mode, there are three different ways to create a printout. The first method is to press the Enter key at the end of a test. The second method is to press the Enter key from the Results screen. The third way is to press the Print Results soft key from the Perform test screen. In the OFF mode, the printer card and printer menu are disabled.

Test Result

From the Print Format setting screen, press the “Test Result” soft key. As the soft key is pressed, the display will toggle between the words “All” and “Fail only”. This command selects which test results will be printed, “All”, selects printing all test results and “Fail only”, selects printing only failed test results.

Test Setting

From the Print Format setting screen, you may turn the Test Setting print enable ON and OFF by pressing the “Test Setting” soft key. This command selects printing the test parameters as well as the test results.

Device ID

The Device ID number is a counter that increments once every time a test is performed. The number can be set to match the exact serial number or some portion of actual serial number of the item under test or just used as an identifier or tracking number. From the Print Format setting screen, use the numeric keypad to select the initial Device ID. Finish by pressing the ENTER key. This number is not saved as part of the non-volatile system parameters, therefore each time the power to the instrument is turned off the number will be reset to 1.

Form Feed

From the Print Format setting screen, you may turn the Form Feed ON and OFF by pressing the “Form Feed” soft key. This command forces a form feed after each complete test sequence. When the form feed is turned off, the signature line will not appear. When the form feed is turned off the pages will break whenever the page is determined to be full by the printer.

Print Report Example

```

=====
Model: 8207      Serial Number: 9680004   Time:14:45:45   Date:2012/11/06
Device ID:      1                          Test File: 1
=====

```

TEST00001 Setting: ACW

```

Voltage      1240V      HI-Limit T   10.00mA      LO-Limit T   0.000mA
Ramp Up      0.1s        Dwell Time   1.0s         Ramp Down    0.0s
Arc Sense    5            HI-Limit R   10.00mA      LO-Limit R   0.000mA
Offset       0.000mA
Frequency    60Hz        Arc Detect    OFF           Continuity    OFF

```

TEST00001 Result: Pass

```

Voltage      1.24kV      Current T    0.003mA      Current R    0.000mA
Time         1.0s

```

TEST00002 Setting: DCW

```

Voltage      1200V      HI-Limit     10000uA      LO-Limit     0.0uA
Ramp Up      0.4s        Dwell Time   1.0s         Ramp Down    0.0s
Charge LO    0.0uA      Arc Sense    5            Offset       0.0uA
Ramp-HI      OFF         Arc Detect    OFF           Continuity    OFF

```

TEST00002 Result: Pass

```

Voltage      1.20kV      Current      0.0uA        Time         1.0s

```

TEST00003 Setting: GND

```

Current      25.00A     Voltage      8.00V        HI-Limit     0mohms
LO-Limit     0mohms     Dwell Time   1.0s         Offset       0mohms
Frequency    60Hz       DualCHEK     OFF

```

TEST00003 Result: Pass

```

Current      0.01A      Resistance    >200mohms    Time         1.0s

```

TEST00004 Setting: IR

```

Voltage      500V       HI-Limit     0.00Mohms    LO-Limit     0.1Mohms
Ramp Up      0.1s       Dwell Time   0.5s         Delay Time   1.0s
Ramp Down    0.0s       Charge LO    0.000uA

```

TEST00004 Result: Pass

```

Voltage      500V       Resistance    >50Gohms     Time         0.5s

```

TEST00005 Setting: CONT.

```

HI-Limit     0.00ohms    LO-Limit     0.00ohms     Dwell Time   1.0s
Offset       0.00ohms

```

TEST00005 Result: Pass

```

Resistance    >10Kohms    Time         1.0s

```

TEST00006 Setting: RUN

```

Voltage-HI    125.0V     Voltage-LO    0.0V         Amp-HI       10.00A
Amp-LO       0.00A     Dwell Time    1.0s         Delay Time   0.2s
Leakage-HI   10.00mA    Leakage-LO    0.00mA       Power-HI     1000W
Power-LO     0W         PF-HI        1.000        PF-LO        0.000
Continuous   OFF
Voltage      115.0V     Frequency     60.0Hz       A-HI         0.0A
Output N/G   OPEN       Volt Range    LOW           OC-Fold      OFF

```

TEST00006 Result: Pass

```

Voltage      114.7V     Current       0.00A        Power        1W
Time         1.0s      Leakage       0.00mA       PF           0.000

```

```

TEST00007 Setting: LLT
Leakage-HI 6000uA Leakage-LO 0.0uA Voltage-HI 125.0V
Voltage-LO 0.0V Dwell Time 0.5s Delay Time 1.0s
Neutral CLOSED Reverse OFF Ground CLOSED
Offset 0.0uA Mea. Device UL544NP
Probe Ground To Line
Leakage RMS Continuous OFF AC/DC AC+DC
Ranging Mode Auto
Voltage 115.0V Frequency 60.0Hz A-HI 0.0A
Output N/G OPEN Volt Range LOW OC-Fold OFF

```

```

TEST00007 Result: Pass
Voltage 114.7V Leakage-R 0.0uA Time 0.5s
I-Maximum 0.0uA MD Volt-R 0.1mV

```

Tested By: _____

09 Ethernet Card

The Ethernet Card option provides RS-232 and Ethernet communication interfaces, as well as barcode scanning capability.

The Ethernet Card has three input/output ports, shown in the following figure:

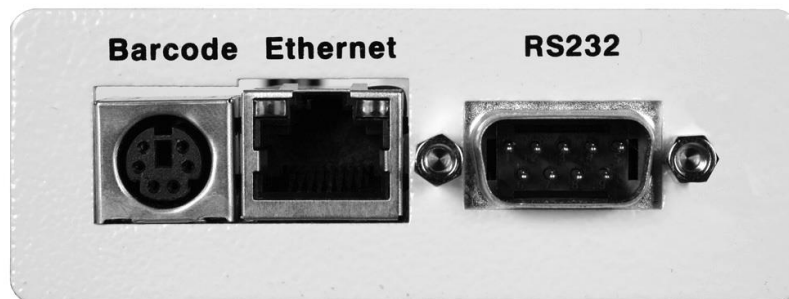

The port labeled “Barcode” is a PS/2-type connector that is used for the connection of a barcode scanner. The Ethernet port is for use with a standard CAT-5 Ethernet cable and may be connected to any compatible PC. The 9-pin D-type subminiature connector labeled “RS232” is for connection of the OMNIA to an RS-232 communication bus.

RS-232 Interface

The protocol for interfacing and communicating using the RS-232 interface can be found in section 7. **Bus Remote Interface USB/GPIB/RS-232** of this manual.

Ethernet Interface

The Ethernet interface provides all of the function control of the standard RS-232 interface. Some commands are only exclusive to GPIB control.

Default Settings

The default settings for the Ethernet interface are as follows:

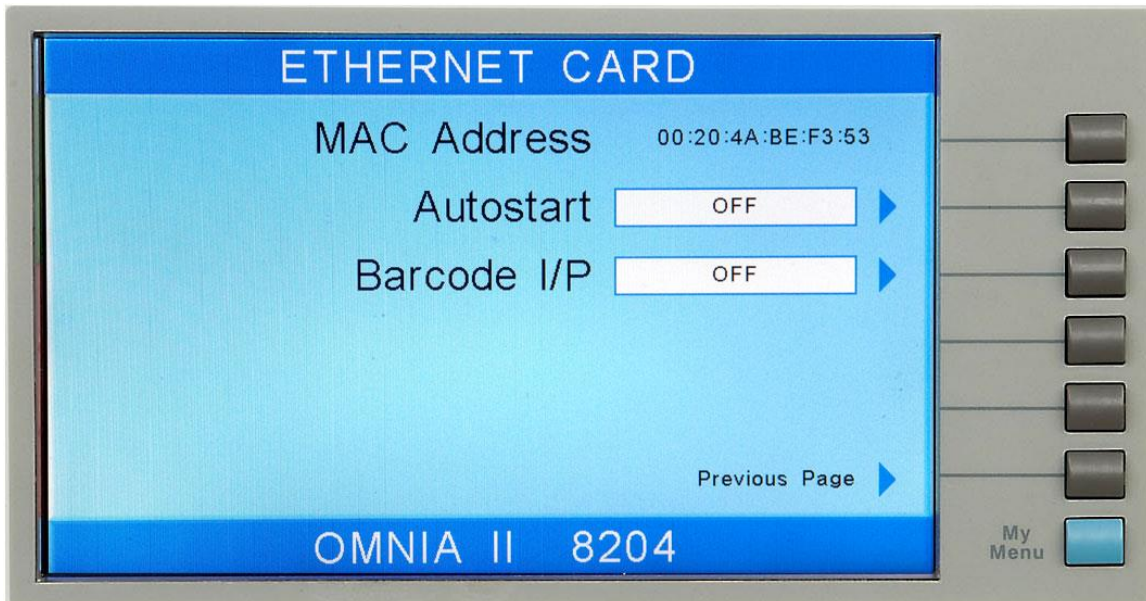
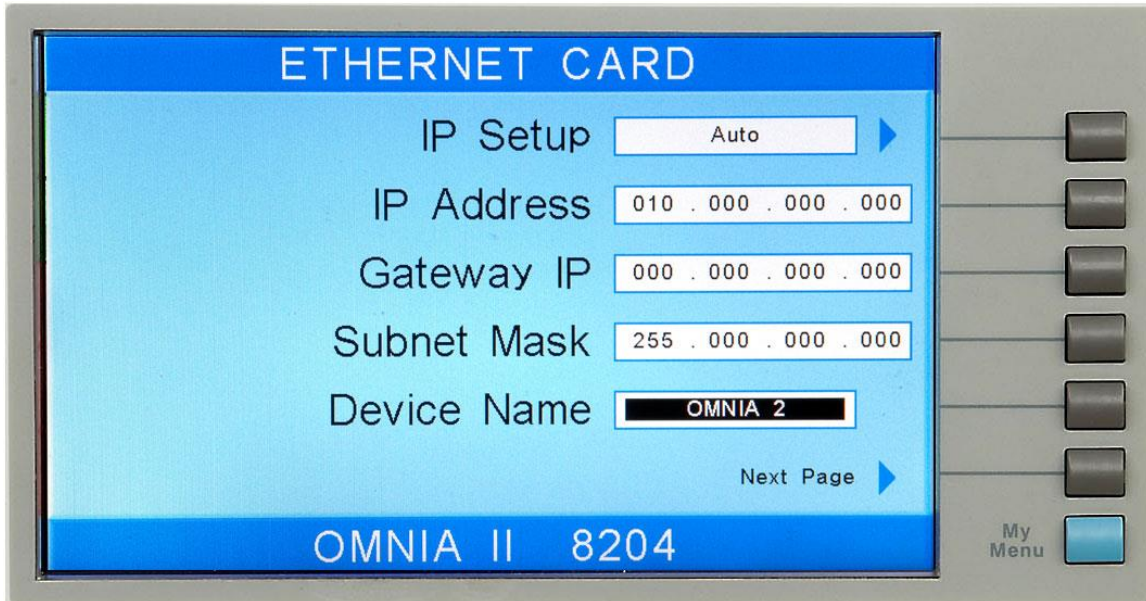

The source port number for the Ethernet Card in TCP connections is 10001.

Ethernet Card Setup

In order to setup the Ethernet card, the operator will need information from the local network administrator. Please have your network administrator fill out the required information on the next page and keep it for your records:

**Associated Research, Inc.
Ethernet Card Communications Information
(To be completed by Network Administrator)**

Ethernet Card Address: _____:_____:_____:_____:

Device Name: _____

Device IP Address: _____.

Gateway IP Address: _____.

Subnet Mask: _____.

Saving New Settings

Any time the user edits one of the Ethernet Card parameters and exits the Ethernet Card Settings menu, the following message will be displayed:

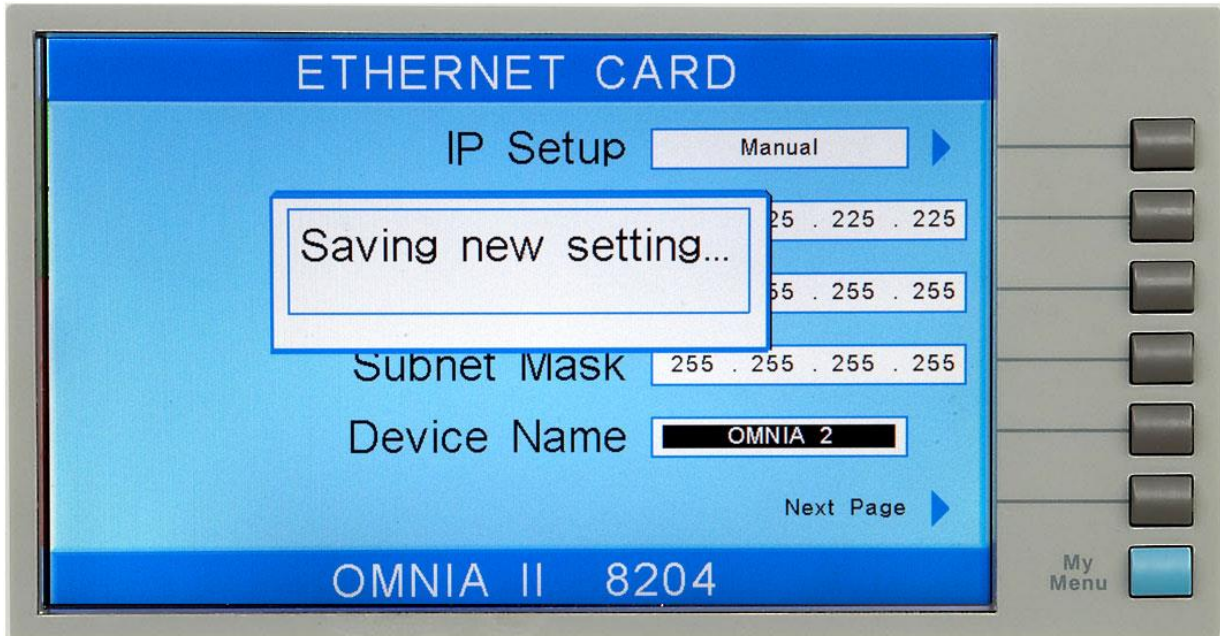

The Ethernet Card will attempt to re-establish a connection with the server anytime the user modifies a parameter and exits the Ethernet Card Parameters Menu or uses the command set at the end of this option description. Thus, if the IP Setup is set to AUTO, the Ethernet Card will request a new IP Address every time a parameter is edited and, as a result, the "Requesting IP Address. . ." message will appear.

Power Up

The Ethernet Card will be installed with the default options listed above. After the OMNIA II initially powers up, the following pop-up message will appear:



- **NOTE:** The “Requesting IP Address...” pop-up message only appears at power up when the Ethernet Card has its IP Setup configured to AUTO.

There are two options to choose from this screen. Press the EXIT key to escape from this screen and stop the OMNIA II from requesting an IP address or allow the OMNIA II to request an IP address automatically from the network to which it is connected.

The Ethernet Card will wait for an IP Address for approximately 20 seconds. If the OMNIA II successfully receives an IP Address from the server the following pop-up message will be displayed:

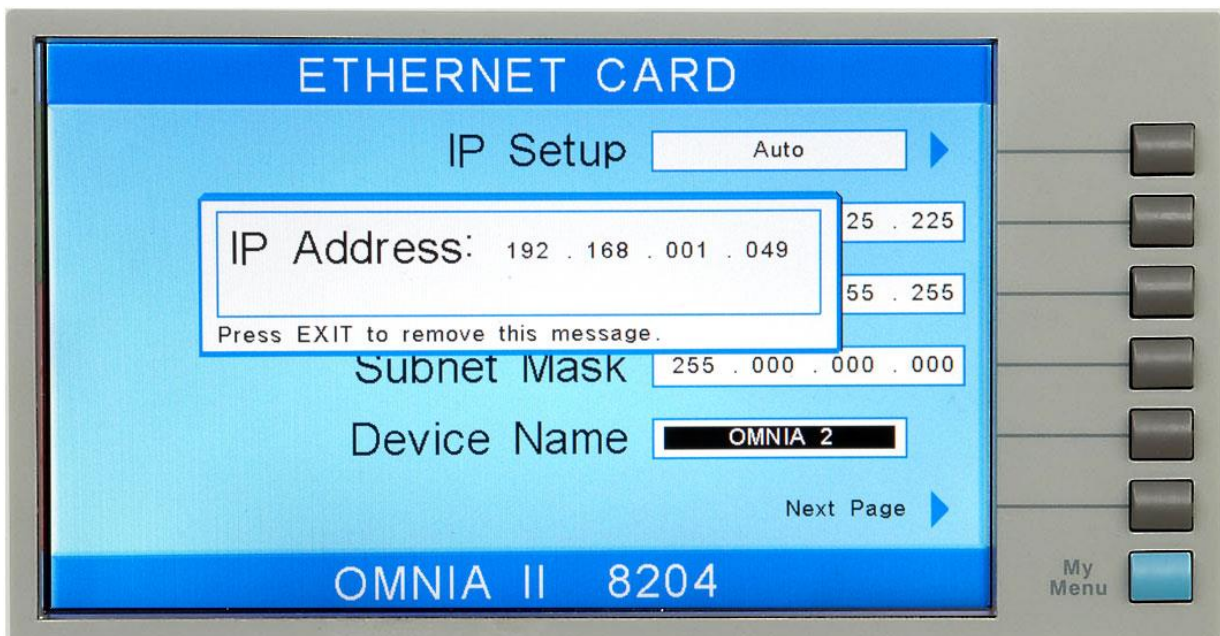

If the OMNIA II fails to receive an IP Address after approximately 20 seconds, the following pop-up message will be displayed:



Press the EXIT key to remove the pop-up message and return to the OMNIA II's Main Menu Screen.

Ethernet Card Menu

When the Ethernet Card option is installed, the Ethernet Card Menu will appear in the Setup System Screen as shown below:

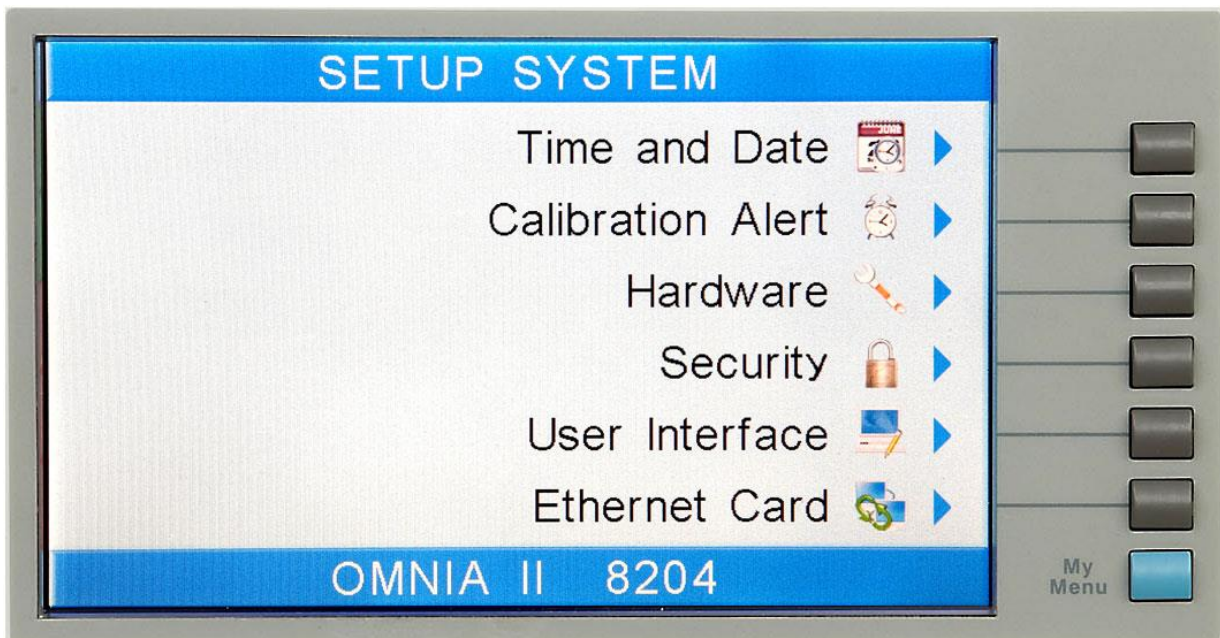

To access the Ethernet Card Menu, press the "Ethernet Card" soft key from the Setup

System screen. The Ethernet Card Parameters screen will now be displayed as shown below:

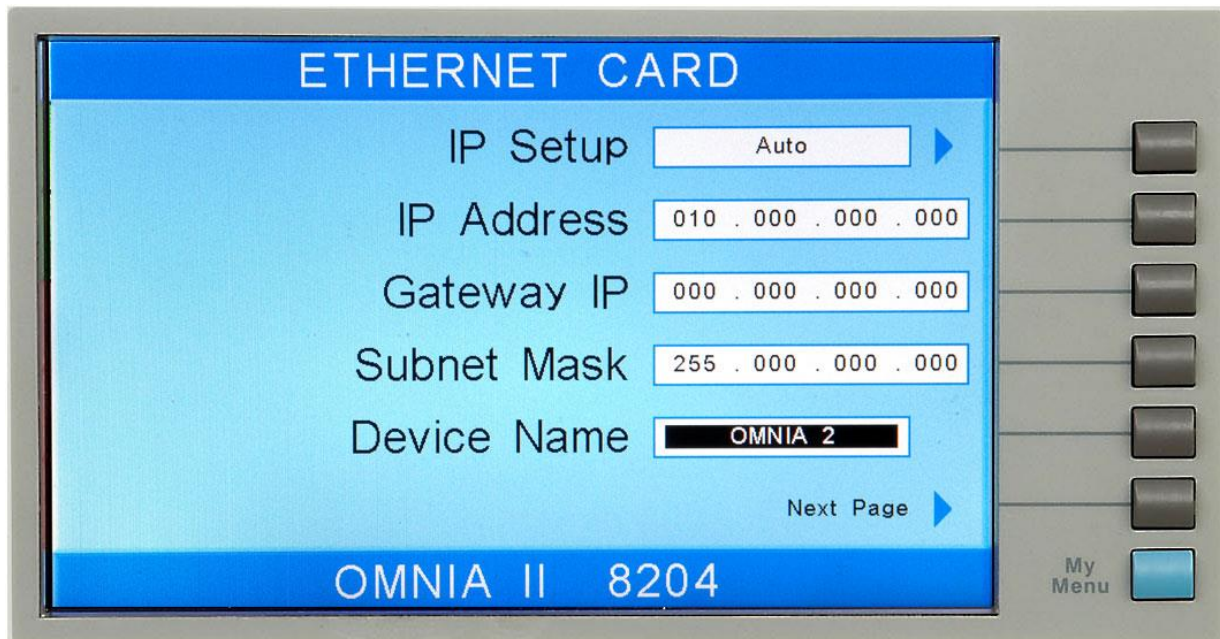

From the Ethernet Card Parameters screen, six different parameters may be accessed: IP Setup, IP Address, Gateway IP, Subnet Mask, Device ID, and Next Page.

IP Setup

The “IP Setup” soft key is used to determine how the OMNIA II will request an IP address from the server to which it is connected. The IP Setup may be configured as AUTO or MANUAL by pressing the “IP Setup” soft key.

When AUTO is selected, the OMNIA II will attempt to automatically request an IP Address from the server upon power up. To resolve the IP Address automatically, the OMNIA II will use DHCP or BOOTP protocols. When MANUAL is selected, the OMNIA II will request a specific IP Address from the server. The IP Address that will be requested must be entered in the subsequent IP Address parameter field.

IP Address

A specific IP Address must be entered into this field if the IP Setup parameter is configured to MANUAL. Use the arrow keys to highlight this parameter. Once the parameter is highlighted, enter the IP Address that you wish using the numeric keypad. The IP Address must be entered in the following format: XXX.XXX.XXX.XXX. A valid IP Address must be entered. Users may not use the following IP Addresses:

255.255.255.255
000.000.000.000

Enter the preceding IP Addresses will cause the following error message to be

displayed:

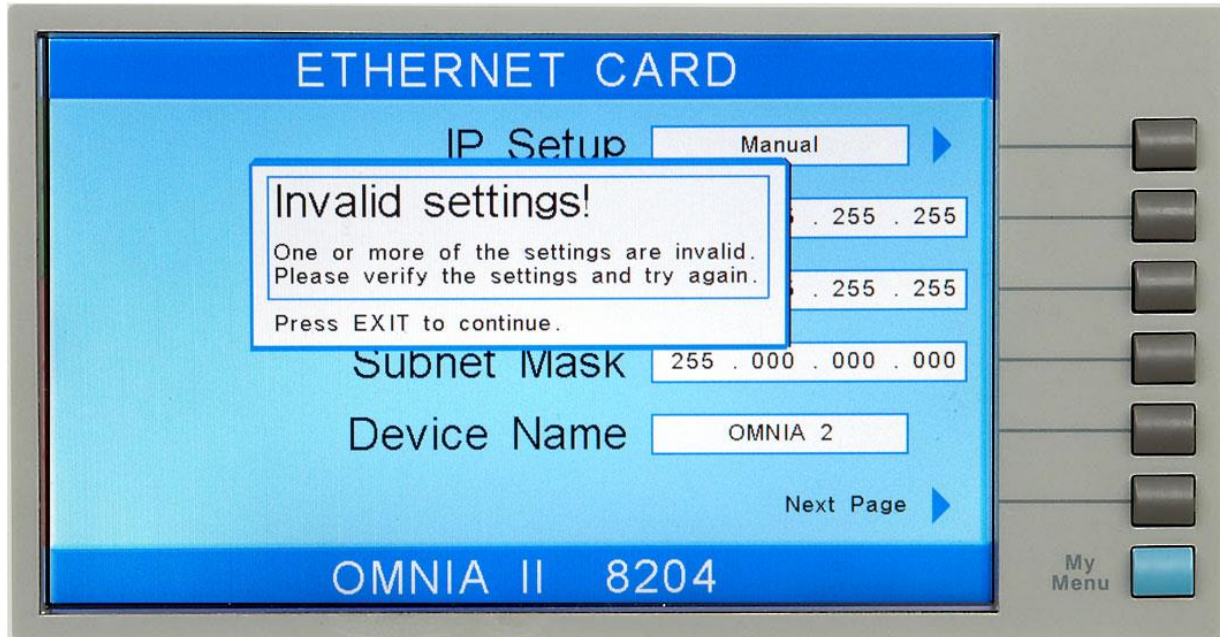

Press the EXIT key to save the new settings. If the IP Setup parameter is set to AUTO, you do not need to enter an IP Address manually.

Gateway IP

A specific Gateway IP must be entered into this field if the IP Setup parameter is configured to MANUAL. Use the arrow keys to highlight this parameter. Once the parameter is highlighted, you may enter the Gateway IP using the numeric keypad. The Gateway IP must be entered in the following format: XXX.XXX.XXX.XXX. Press the EXIT key to save the new settings. If the IP Setup parameter is set to AUTO, you do not need to enter a Gateway IP manually.

Subnet Mask

A specific Subnet Mask must be entered into this field if the IP Setup parameter is configured to MANUAL. Use the arrow keys to highlight this parameter. Once the parameter is highlighted, you may enter the Subnet Mask using the numeric keypad. The Subnet Mask must be entered in the following format: XXX.XXX.XXX.XXX. If an invalid Subnet Mask is entered the following error message will be displayed:

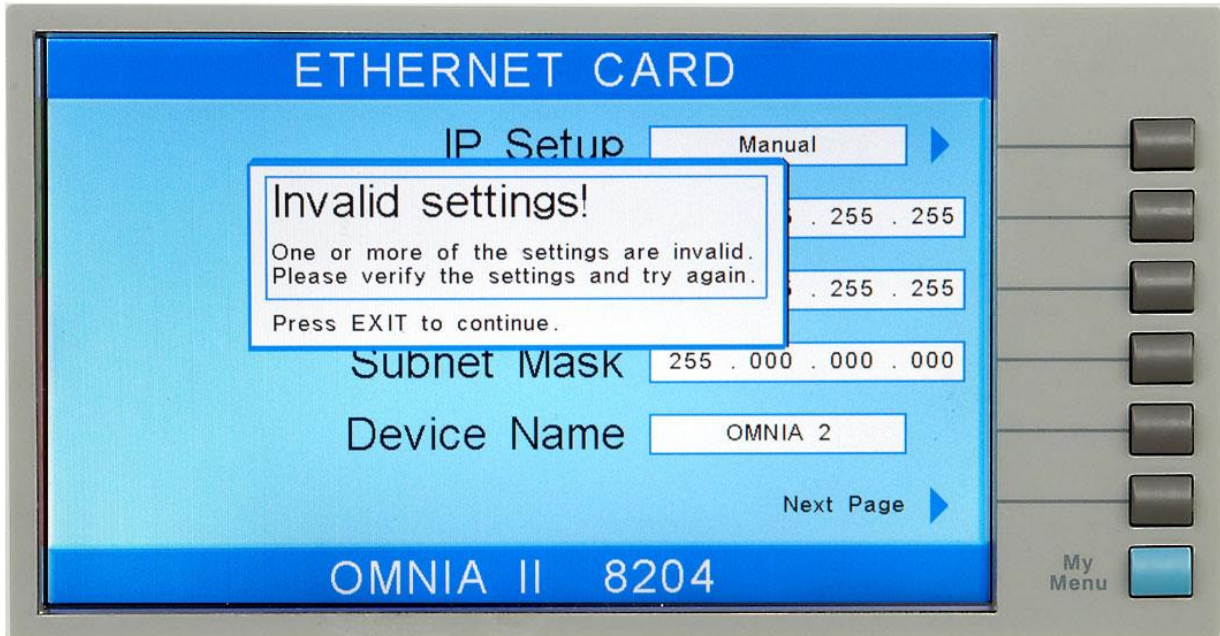

Press the EXIT key to save the new settings. If the IP Setup parameter is set to AUTO, you do not need to enter a Subnet Mask manually.

Device Name

The Device Name is used to identify the OMNIA II on your server and may be used in place of a dedicated IP Address. Use the arrow keys to highlight this parameter. Once the parameter is highlighted, you may enter the Subnet Mask using the numeric keypad. The Device Name may be a maximum of eight characters and MUST start with a letter.

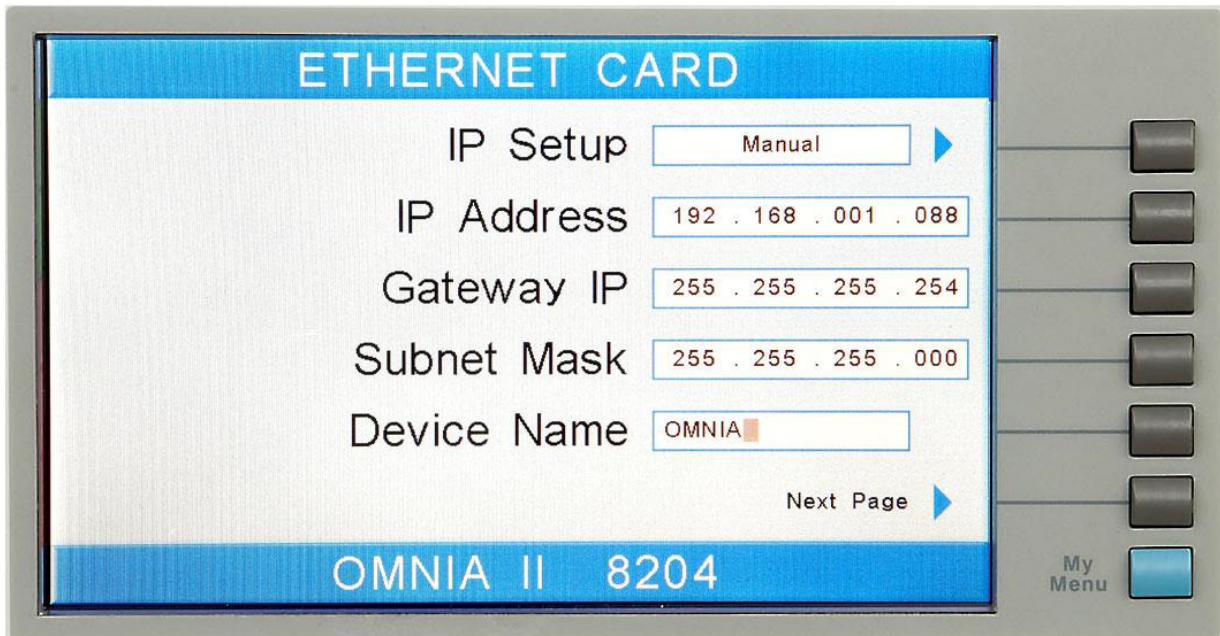

If the Device Name does not start with a letter the following error message will be

displayed:

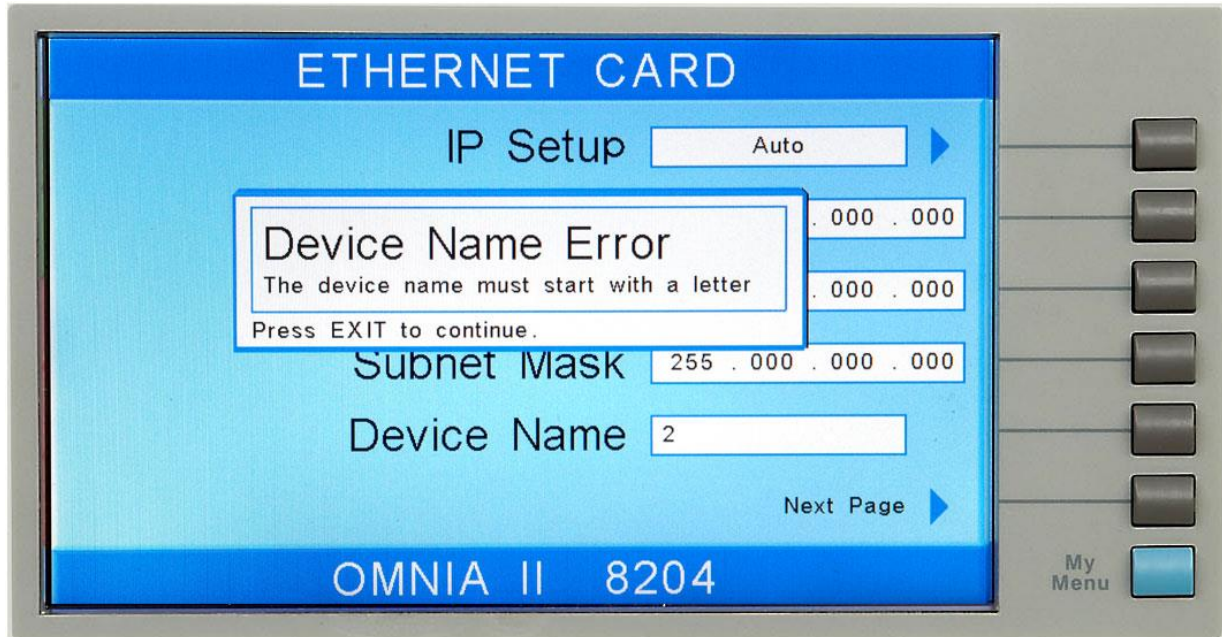

When the Device Name has been entered, press the EXIT key to save the new settings. The Device Name parameter is only active when the IP Setup is set to AUTO.

Next Page

Press the “Next Page” soft key to bring up additional parameters as shown in the following screen:

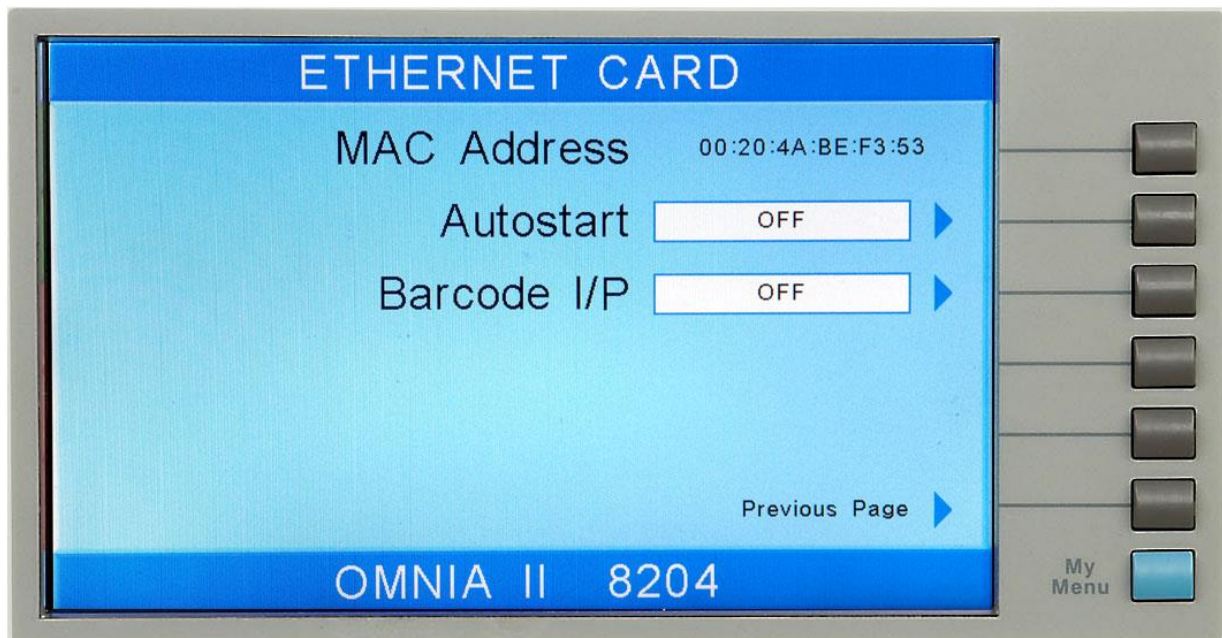

From this screen, four parameters may be accessed: MAC Address, Barcode I/P,

Autostart, and previous.

MAC Address

View the MAC address of the Ethernet Card here. This parameter is not adjustable.

Barcode I/P

Press the “Barcode I/P” soft key to select the type of Barcode input.

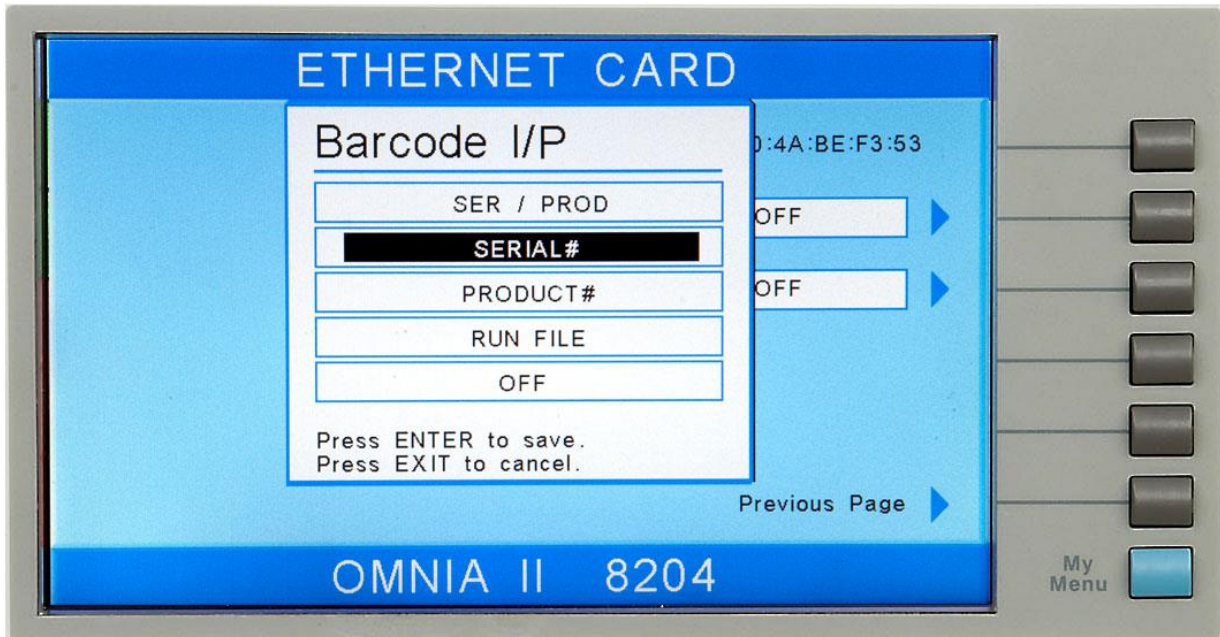

The Barcode I/P parameter can be set to SERIAL#, PRODUCT#, SER/PROD, OFF or RUN FILE. When the setting is SERIAL#, PRODUCT# or SER/PROD, the user can scan barcodes in the Perform Tests screen before the test is started. When a barcode is scanned, one of the following messages will appear on the display.

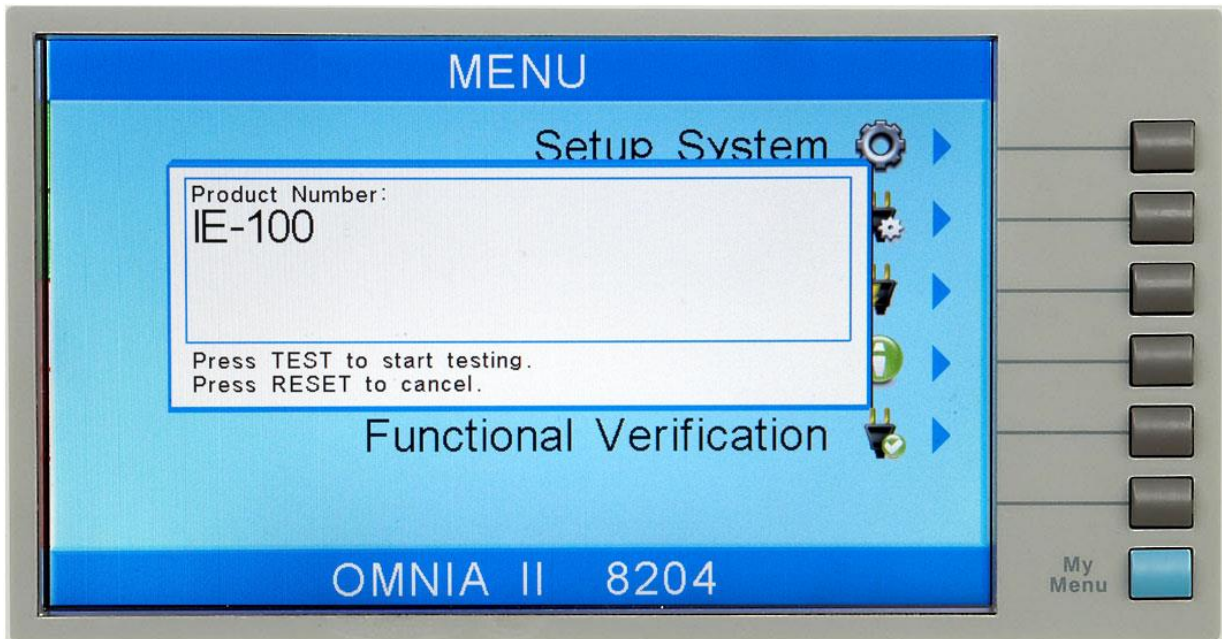
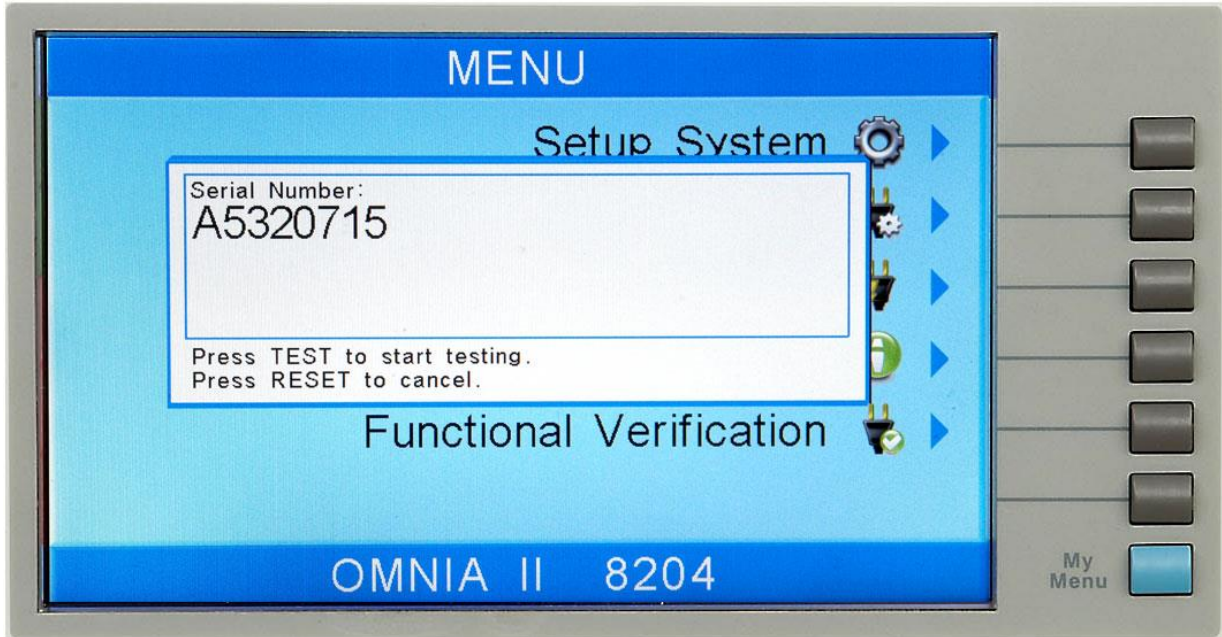

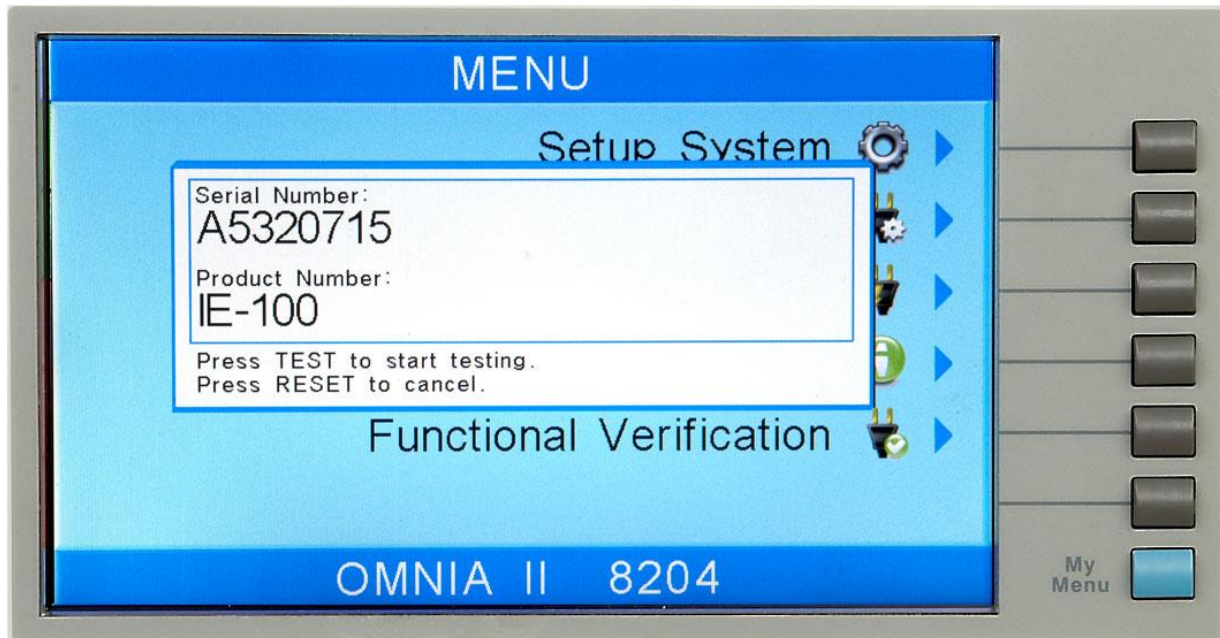

After the barcodes are scanned, press TEST to initiate the test sequence. Pressing RESET will abort the TEST sequence.

The Ethernet Card permits re-scanning of barcodes if the previously scanned barcode was incorrect. Re-scanning is only available in the SERIAL#, PRODUCT# and SER/PROD modes. If the user decides to re-scan barcodes when the Barcode I/P setting is set to SER/PROD, the Ethernet Card will first replace the data in the Serial Number field, and if the user re-scans another barcode, the Ethernet Card will replace the data in the Product Number field.

The RUN FILE selection gives the user the ability to automatically load and execute a test file based on what barcode is scanned from the Perform Tests screen. In order for this feature to work, the user must name the desired test file with the exact alphanumeric code that is on the product's barcode label. For example, if Product A has barcode "123456789", then the test file that the user would like to run when testing Product A should be named "123456789". When the product's barcode is scanned, the OMNIA will immediately execute the test associated with that barcode. The test file name is limited to 10 characters. However, if the user names a test file with the maximum 10 characters, this function will still initiate a test when a product's barcode begins with those first 10 characters even if the barcode has more than 10 characters.

WARNING

Using the RUN FILE feature will enable the instrument's output once the barcode is scanned. Do not touch the DUT at any time when using this feature in order to avoid potential shock or serious injury.

When using a barcode scanner, the OMNIA II's responses to the TD? and RD x? commands will differ slightly from an OMNIA II with the standard RS-232 interface. For all types of tests (ACW, DCW, IR, GND, CONT, LCT, RUN) two fields are added to

the end of the standard response when the Barcode I/P setting is set to SERIAL#, PRODUCT# or SER/PROD. The first field contains the Serial Number information and the second field contains the Product Number information. Both fields are included regardless of which of these three modes are selected. The Ethernet Card will substitute a “0” for the field if it is not applicable to the setting. For example, if a user had their Barcode I/P setting set to SERIAL#, and scanned a Serial Number with the value “123456789”, the TD? response for an ACW test could be:

01,ACW,Pass,1.24,1.000,0.900,1.0,123456789,0

Note that there is a “0” in the Product Number field because the Barcode I/P setting is SERIAL#.

When the Barcode I/P setting is RUN FILE or OFF, these fields are not included in the TD? and RD x? responses.

Autostart

Press the “Autostart” soft key to enable or disable the Autostart feature. When Autostart is enabled, the test will execute as follows:

If the Barcode I/P is set to PRODUCT#, scan the barcode once to input it into the OMNIA II. The OMNIA II will then search for a test file name that matches the product number barcode string. If the OMNIA II finds a match, it will load the file into RAM. When the same product number barcode is scanned a second time, the test will be executed automatically. If OMNIA does not find a file name that matches the barcode string, the unit will beep – notifying the user that it did not find a matching file name. The test file name is limited to 10 characters. However, if the user names a test file with the maximum 10 characters, this function will still load a test file if the first 10 characters of the product number match the file name.

If the Barcode I/P is set to SER/PROD, scan the serial number once to input it into the OMNIA. Next, scan the product number. From this point, OMNIA II will operate the same as when the Barcode I/P setting is set to PRODUCT#.

The Autostart feature will not work with the SERIAL# setting.

The Autostart feature will enable the instrument’s output once the product number barcode is scanned a second time when in the PRODUCT# and SER/PROD modes. Do not touch the DUT at any time when using this feature in order to avoid potential shock or serious injury.

Ethernet Card Settings Commands and Companion Queries

COMMAND	NAME	VALUE
SIM {1 0} SIM?	Set IP Mode	1=Manual, 0=Auto (DHCP/BOOTP)
SIA <value> SIA?	Set IP Address	Dotted decimal form. Ex. 192.168.1.50
SGA <value> SGA?	Set Gateway IP Address	Dotted decimal form
SSM <value> SSM?	Set Subnet Mask	Dotted decimal form
SDN <value> SDN?	Set Device Name	8 character max, must start with a letter
MAC?	MAC Address Query	Example response: 00:20:4A:8B:B4:30
SBI {0 1 2 3 4} SBI?	Set Barcode Input	0=Off, 1=Ser/Prod, 2=Serial#, 3=Product#, 4=Run File
SAS {1 0} SAS?	Set Autostart	0=Off, 1=On

Communication Considerations

- All of the above commands (excluding the query commands) will respond with the 06 hex (6 decimal) Acknowledge (ACK) ASCII control code if the transfer was recognized by the instrument.
- If there was an error with the command string, the instrument will respond with 15 hex (21 decimal), the Not Acknowledge (NAK) ASCII control code.
- However, the presence of this response does not mean that the instrument (in the case of these commands only) completed the command. These commands require a restarting of the hardware that controls the Ethernet Protocols. Because of this, the user must wait before the Ethernet Card will respond to another command. See the table below for the approximate wait times necessary after one of the commands in the table is sent. In addition, the current socket connection between the user's terminal and the Ethernet Card is no longer valid, and the user will need to close their current connection and establish a new one.

Ethernet Card Settings Command Wait Times

IP MODE	COMMAND	WAIT TIME AFTER COMMAND IS SENT*
Manual	SIA, SGA, SSM	8 seconds
	SIM 0	14 seconds
Auto	SDN	14 seconds
	SIM 1	8 seconds

*Wait times are approximate and can vary based on the user's network.

10 GPIB Card

This option provides all of the function control of the RS232 interface with the addition of SRQ functions. All commands can be found in section 7. **Bus Remote Interface USB/GPIB/RS-232** of this manual.

11 DUT Output Relay Controls (Models 8206 Only)

This option provides additional settings to control the DUT Output L and N terminals during ACW, DCW and IR tests. When this option is installed and the DUT-HV setting is enabled in the Setup System screen an additional parameter will be available in the ACW, DCW and IR Test Parameter Settings screen. The operator can configure the DUT Output L and N terminals to O (off), H (which places them at high potential) or L (which places them at return potential). Refer to the table below for more details.

State Selection (DUT-HV ON)	Description
L	DUT L, N connected to Return
H	DUT L, N connected to HV
O	DUT L, N not connected (OFF)

14 400/800 Hz Hipot Output (Models 8206 Only)

The 400/800 Hz Hipot Output option adds additional frequency selection to the ACW test. Now, instead of just 50/60 Hz selection, you will be able to select 50, 60, 400, and 800 Hz frequency for an ACW test.

The specifications for the 50/60Hz operation will remain the same except for the SGFI Trip Current. The following specifications apply to the 400/800 Hz option and include the new SGFI Trip Current specification for 50/60 Hz and DCW.

AC Total Current	\pm (3% of reading + 2 counts)
AC Real Current	\pm (5% of reading + 100 μ A)
Voltage Display	\pm (3% of reading + 10 V)
Voltage Setting	\pm (3% of reading + 2 counts)

NOTE: If a Hipot test is set to 400/800Hz, it is recommended to adjust the SmartGFI to a minimum trip level of 1.6mA. Higher frequency Hipot tests will create higher leakage current values so this could cause false GFI failures.

The following USB/RS232 and GPIB Test Parameter Editing Command and Companion Query have been modified for use with the 400/800Hz option.

EF {0 1 2 3} EF?	Edit Frequency	ACW	0=50Hz, 1=60Hz, 2=400Hz, 3=800Hz
---------------------	----------------	-----	-------------------------------------

The ADD command may also be used to enter the 400Hz and 800Hz frequency selection. Please reference the USB/RS232/GPIB section of the manual for additional information regarding the ADD command.

- **NOTE:** Due to increased leakage caused by the high frequency output of the 400/800 Hz waveforms, the SmartGFI feature may return a false failure at low settings. Increasing the level of the SmartGFI detection parameter may be required.
- **NOTE:** 500VA models (8256/8257) may produce false arc failures at 800 Hz. In order to prevent false failures, please set the Arc Level to 7 or less at output current levels > 50mA.

15 3mA AC/DC Output (Discontinued)

The 3 mA AC and DC Output option limits the Dielectric Withstand Test Mode output current with software control. The trip points are adjusted to a maximum of 3 mA and the software has been modified so the high-speed maximum current shutdown is fixed at 3 mA.

The revised Dielectric Withstand Test Mode specifications are as follows

INPUT	
Voltage	115 / 230V auto-range, $\pm 15\%$ variation
Frequency	50/60 Hz $\pm 5\%$
Fuse	115 VAC, 230VAC – 10A Slow-Blow 250VAC
DIELECTRIC WITHSTAND TEST MODE	
Output Rating	5KV @ 3mA AC 5KV @ 3mA AC (Models 825x) 6KV @ 3 mA DC
HI and LO-Limit	
AC Total	Range: 0.000 – 3.000mA Resolution: 0.001mA Accuracy: $\pm (2\% \text{ of setting} + 2 \text{ counts})$
AC Real	Range: 0.000 – 3.000mA Resolution: 0.001mA Accuracy: $\pm (3\% \text{ of setting} + 50 \mu\text{A})$
DC	Range: 0.0 – 999.9 μA Resolution: 0.1 μA Range: 1000 – 3000 μA Resolution: 1 μA Accuracy: $\pm (2\% \text{ of setting} + 2 \text{ counts})$

NOTE: The metering is capable of reading more than the output capacity of the instrument. The automatic range selection will still be used as required by the applied DUT.

DIELECTRIC WITHSTAND TEST MODE (CONT.)	
Current Display	Auto Range*
AC Total	Range 1: 0.000 mA – 3.500 mA RMS (0.000 mA – 5.500 mA Peak) Resolution: 0.001 mA Range 2 : 3.000 mA – 50.00mA RMS (5.000 mA – 70.07 mA Peak)
AC Real	Resolution: 0.01 mA Accuracy: ± (2% of reading + 2 counts) All Ranges Range 1: 0.000 mA – 9.999 mA Accuracy: ± (3% of reading + 50µA) All Ranges PF > 0.1 V > 250VAC
DC	Range 1: 0.0 µA – 350.0 µA DC (0.0 µA – 550.0 µA Peak) Resolution: 0.1 µA Range 2 0.300 mA – 3.500 mA DC (0.400 mA – 5.500 mA Peak) Resolution: 0.001 mA Range 3 3.00 mA – 20.00 mA DC (4.00 mA – 25.00 mA Peak) Resolution: 0.01 mA Accuracy: ± (2% of reading + 2 counts) All Ranges

16 Prompt Interlock Option

The Prompt Interlock Option allows user the flexibility to disable the interlock during a prompt without aborting the test. Normally, during a Run or LCT test, if the interlock is broken, the unit aborts the test sequence as a safety feature. With Option 16 installed, the user will be able to continue the test from the step where a prompt occurs. For DUT's being tested in a safety enclosure, it is sometimes required, during a prompt, to open the enclosure (break the interlock) and make some changes to the connection to the DUT. In such a situation, the Prompt Interlock option will prevent the Omnia II from aborting the test, allowing the user to continue testing from where the prompt had occurred. For Leakage Current and Run test, the **Active Link** feature should be set to OFF in order for this option to work.

17 GB Voltage (Discontinued)

The GB Voltage Option allows user to set up Voltage Hi-Limit and Lo-Limit during AC Ground Bond test. During the test the Omnia II's display shows a Voltage meter that reflects the amount of Voltage dropped across the device under test.

From the Setup Tests Selection screen, press the "Add" soft key. The test types soft keys will now be displayed. From the Setup Tests Selection screen, press the "AC Ground Bond" soft key. The Ground Bond Parameter Setting screen will now be displayed. The Ground Bond Parameter Setting screen will appear as follows:

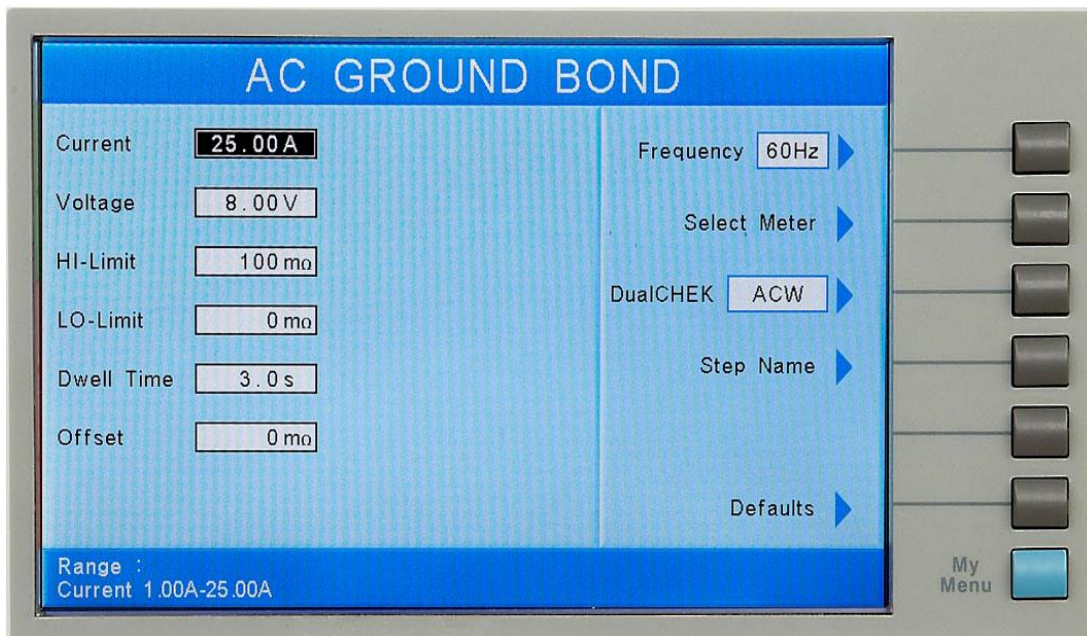

From the Ground Bond Parameter Setting screen, the following parameters may be controlled: Current, Voltage, HI-Limit, LO-Limit, Dwell Time, Offset, Scanner Channel, Frequency, DualCHEK, Step Name and Defaults.

Offset

This function allows the instrument to compensate for lead and test fixture voltage drop during a Ground Bond. Using the up and down arrow keys or the ENTER key, scroll the highlighted area to the Offset parameter. You may now manually or automatically set an Offset value.

To manually set an Offset value enter a Volt value via the numeric keypad and then press the ENTER key to accept the new value or press the EXIT key to escape from the edit.

To automatically set an Offset value set the output voltage, current, and frequency to

the values that will be used on the DUT and connect the test cables, test fixture, or Scanner channel to the instrument. Next, short the ends of the test cables and press the TEST button. The highlighted parameter field will briefly show the word “READING” and then display the new value. The new value is automatically updated in the field and does not allow an escape to the original value or require that the ENTER key be used to accept the new parameter.

DualCHEK

This function allows the instrument to simultaneously run a hipot and AC Ground Bond test. While pressing the “DualCHEK” soft key, the DualCHEK pop up screen will appear as follows:

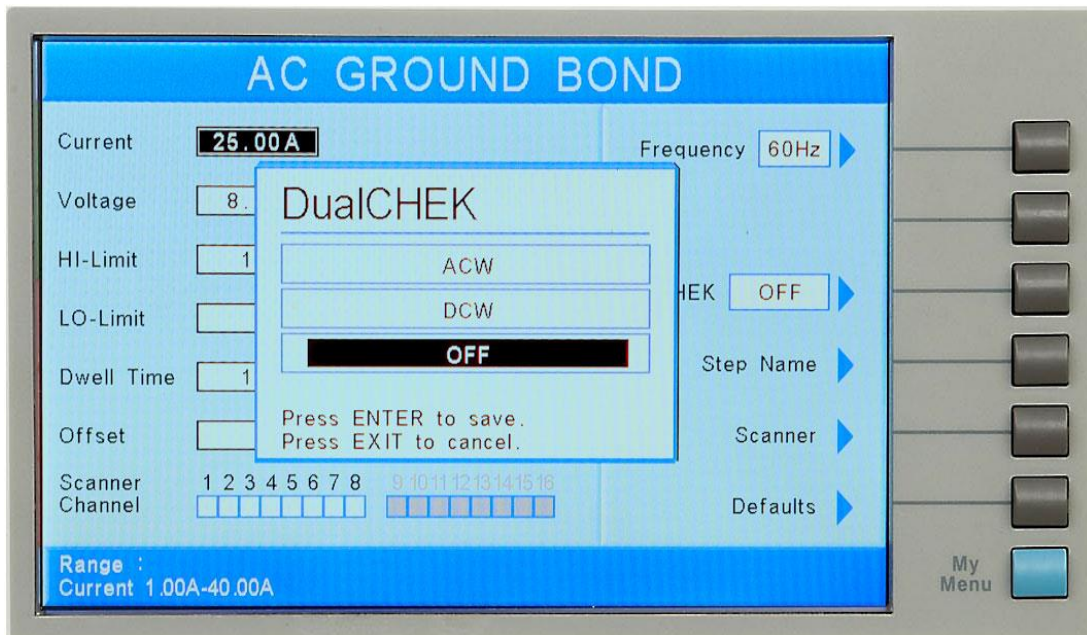

Use the up or down arrow keys to select the DualCHEK setting for this test. The DualCHECK setting options are ACW, DCW or OFF.

Once a parameter is edited, it is necessary to complete the edit either by pressing the ENTER key to accept the new value or the EXIT key to escape from the edit and return to the original value.

For the DualCHEK to function properly, the test immediately following the AC Ground Bond test in the sequence must be the test specified in the DualCHEK parameter. For example, if DualCHEK is set to ACW, the next test in the sequence after the AC Ground Bond test must be an ACW test. If the test immediately following the AC Ground test does not match the DualCHEK setting, the AC Ground Bond test and following test will run sequentially.

51 PLC Voltage Control (8206, 8207, 8256, 8257) (Discontinued)

With this option installed, the PLC remote signal output has been reconfigured to provide a Two-Bit digital control signal that is menu selectable at the Run Test parameter setting screen.

When this option is installed, a new soft key selection will appear on the Run Test parameter screen. The new soft key is called Test Voltage and when pressed will change between N, L, and H. The new Run Test parameter screen will appear as follows:

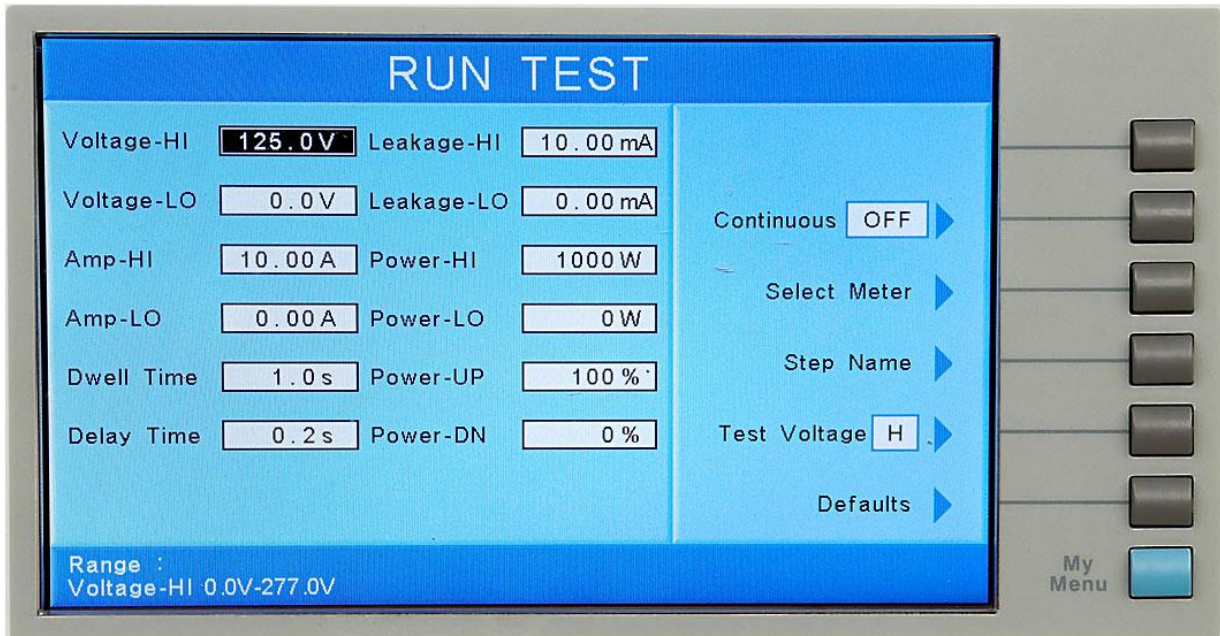

Setting the Test Voltage selection to N, L, and H will create different digital states at Bit 0 and Bit 1 of the PLC Remote Signal Output (refer to the PLC Signal Output drawing below). The different states are described in the truth table below. The “Not used” state is undefined and cannot be programmed for use.

BIT 1	BIT 0	Test Voltage Setting
0	0	N (Nominal)
0	1	H (High)
1	0	L (Low)
1	1	Not used
0 = OPEN		1 = CLOSED

SIGNAL OUTPUT

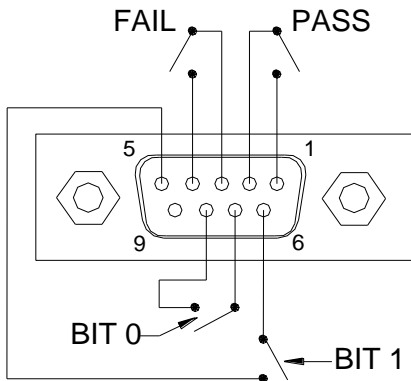

Because the relay that normally provides the processing signal has been reconfigured for voltage control, the Fail and Pass signals have been reconfigured to provide Pass, Fail, and Processing signals. The different states of the Fail and Pass signals are described in the truth table below.

FAIL	PASS	Condition
0	0	After RESET is pressed
0	1	Pass
1	0	Fail
1	1	Processing
0 = OPEN		1 = CLOSED

For questions related to the standard configuration of the PLC remote, please refer to the section titled **Connection of Remote I/O** in the Operations manual.

52 15 Remote Memories Select (8204, 8254, 8206, 8256, 8207, 8257) (Discontinued)

The 15 Remote Memories Select option increases the number of files that may be accessed through the Input remote control connector. Fifteen pre-programmed test files can be accessed by connecting pins 1,6,8, and 9 to the common pin 7, in different combinations. The **Remote File Select Truth Table** (binary) shows the different combinations of momentary switch (relay) closures, and which memory programs that will be selected as the result. It may be necessary to "OR" the momentary switches (relay contacts) to prevent incorrect program selection due to timing errors.

REMOTE FILE SELECT TRUTH TABLE				
BIT 4	BIT 3	BIT 2	BIT 1	FILE #
0	0	0	1	01
0	0	1	0	02
0	0	1	1	03
0	1	0	0	04
0	1	0	1	05
0	1	1	0	06
0	1	1	1	07
1	0	0	0	08
1	0	0	1	09
1	0	1	0	10
1	0	1	1	11
1	1	0	0	12
1	1	0	1	13
1	1	1	0	14
1	1	1	1	15

1= Momentary Contact closure between BIT and COMMON
0= No Contact closure between BIT and COMMON

SIGNAL INPUT

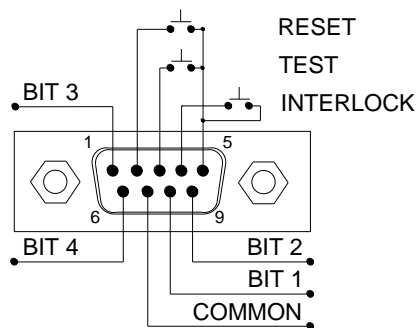

WARNING

Activating file program functions through the remote connector selects the file and starts the test that is pre-programmed into that file.

CAUTION

Do not connect voltage or current to the signal inputs. Applying voltage to the signal input could result in damage to the control circuitry.

54 Reactive Current (8204, 8254, 8206, 8256, 8207, 8257) (Discontinued)

The Reactive Current option allows for the reading of reactive current of a DUT through the GPIB or USB/RS232 Bus.

The following query commands may be used to access the additional reactive current meter:

Command	Name	Value
TD?	List Testing Data	Test In Process
RD <step number>?	List Results Data	step number = 1-30

The ACW test will now display 5 meters through the bus. The order the meters are displayed are Volts, Total Current, Real Current, Timer, Reactive Current.

The formula used for calculating the Reactive Current is:

$$\text{Reactive Current} = \text{the square root of } ((\text{Total Current})^2 - (\text{Real Current})^2)$$

The range, resolution, and accuracy of the reactive current are as follows:

Current Display AC Reactive	Auto Range Range 1: 0.000 mA – 5.999 mA Resolution: 0.001 mA Range 2 6.00 mA – 40.00 mA Resolution: 0.01 mA Accuracy: \pm (Total Current Accuracy + Real Current Accuracy) All Ranges
--------------------------------	--

Example of Reactive Current Accuracy @ 800 Hz:

Total Current Reading = 10.00mA, Total Current Accuracy = (3% of 10.00mA + 0.02mA)

Real Current Reading = 1.000mA, Real Current Accuracy (5% of 1.000mA + 0.1mA)

Reactive Current Reading = 9.95mA

Reactive Current Accuracy

$$= \pm ((3\% \text{ of } 10.00\text{mA} + 0.02\text{mA}) + (5\% \text{ of } 1.000\text{mA} + 0.1\text{mA})) = \pm (0.47\text{mA})$$

55 31 Remote Memory Select (8204, 8254, 8206, 8256, 8207, 8257) (Discontinued)

The 31 Remote Memories Select option increases the number of files that may be accessed through the Input remote control connector. Thirty one pre-programmed test files can be accessed by connecting pins 1,4,6,8, and 9 to the common pin 7, in different combinations. This option substitutes the Interlock Input for bit 5 of the 31 Remote Memory Select option. Therefore, the Interlock Input is not available when this option is selected.

The **Remote File Select Truth Table** (binary) shows the different combinations of momentary switch (relay) closures, and which memory programs that will be selected as the result. It may be necessary to "OR" the momentary switches (relay contacts) to prevent incorrect program selection due to timing errors.

REMOTE FILE SELECT TRUTH TABLE					
BIT 5	BIT 4	BIT 3	BIT 2	BIT 1	FILE #
0	0	0	0	1	01
0	0	0	1	0	02
0	0	0	1	1	03
0	0	1	0	0	04
0	0	1	0	1	05
0	0	1	1	0	06
0	0	1	1	1	07
0	1	0	0	0	08
0	1	0	0	1	09
0	1	0	1	0	10
0	1	0	1	1	11
0	1	1	0	0	12
0	1	1	0	1	13
0	1	1	1	0	14
0	1	1	1	1	15
1	0	0	0	0	16
1	0	0	0	1	17
1	0	0	1	0	18
1	0	0	1	1	19
1	0	1	0	0	20
1	0	1	0	1	21
1	0	1	1	0	22
1	0	1	1	1	23
1	1	0	0	0	24
1	1	0	0	1	25
1	1	0	1	0	26
1	1	0	1	1	27
1	1	1	0	0	28
1	1	1	0	1	29
1	1	1	1	0	30
1	1	1	1	1	31

1= Momentary Contact closure between BIT and COMMON
0= No Contact closure between BIT and COMMON

SIGNAL INPUT

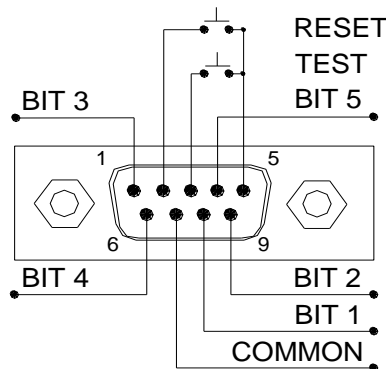

WARNING

Activating file program functions through the remote connector selects the file and starts the test that is pre-programmed into that file.

CAUTION

Do not connect voltage or current to the signal inputs. Applying voltage to the signal input could result in damage to the control circuitry.

56 Power Tracking (Models 8206 Only)

The Power Tracking option is a feature that works along with the Continuous Output Option. In between Run Test steps, if the instrument detects that the power consumed by the DUT has exceeded the user's predefined threshold, it will automatically continue to the next test step.

In the Run Test parameter screen, the user can set the Power-UP and Power-DN parameters as a percent increase or percent decrease of the test step's final power reading. The PF-HI and PF-LO parameters, which are available in the standard unit, are not available when the Power Tracking option is installed. These are replaced by the Power-UP and Power-DN parameters. The new Run Test parameter screen will appear as follows:

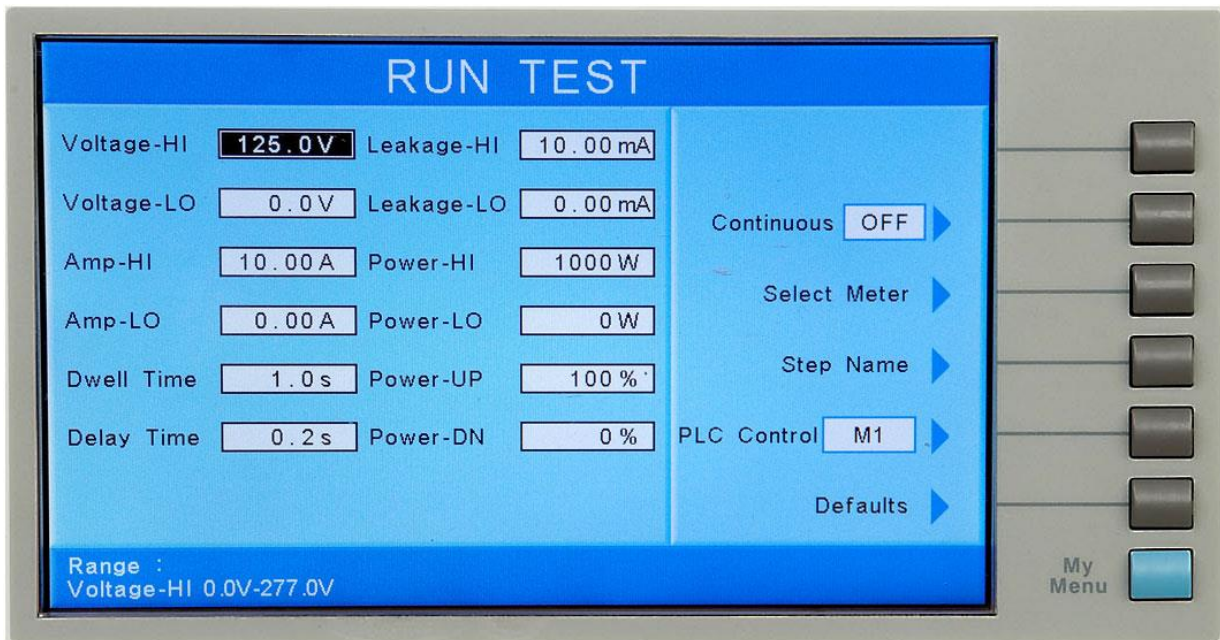

When the Power Tracking and Continuous Output options are installed, the DUT will be connected to the power source during and between test steps. If the power reading increases above the Power-UP percentage or drops below the Power-DN percentage from the previous step, then the next step will begin.

When either the Power-UP or Power-DN parameters are set to a value greater than 0%, in between Run Test steps the instrument will display the message “Please adjust the power level to continue testing”. The user has 60 seconds to adjust the power level above or below the Power-UP and Power-DN thresholds, respectively. If 60 seconds expires before doing so, the test will be aborted automatically and the power will be disconnected from the DUT. The power source to the DUT Outputs, Line and Neutral is also disconnected after multiple tests are completed, when the RESET button is pushed, or when a failure occurs.

When the Power-UP and Power-DN parameters are both set to 0%, the Power Tracking Option will be essentially off. The unit will then not automatically change test steps with an increase or decrease in measured power. The unit will, however, continue to operate under the conditions of the Continuous Output Option. See the Options section of the OMNIA II Operation and Service Manual for more information on the Continuous Output option.

It is important to note that no programmed trip points are monitored during the pause between Run Tests even though the DUT Output is active. Although the trip points are not monitored during a pause, the short circuit protection is always enabled.

WARNING DO NOT TOUCH THE DEVICE UNDER TEST BECAUSE POWER REMAINS ON.

The following commands are affected by the Power Tracking option.

EPFH < value > EPFH?	Edit Power-UP	RUN	0 – 100%
EPFL < value > EPFL?	Edit Power-DN	RUN	0 – 100%

In the standard instrument the above commands were used to modify the PF-HI and PF-LO parameters. The Power-UP and Power-DN parameters also take the place of the PF-HI and PF-LO parameters in the ADD command and the LS? command query.

All other specifications remain the same. Refer to the Specifications section of OMNIA II Operation and Service Manual, for a complete list of all specifications.

57 Hardware Interlock

The Hardware Interlock option is a feature that works along with the standard interlock on the Signal Input. The Hardware Interlock option adds an extra level of redundancy for the interlock feature. The standard interlock is a CPU controlled contact closure between pins 4 and 5 on the Signal Input. For more information on the standard interlock and remote I/O, please refer to Chapter 7: Remote Control in the Omnia II manual.

Remote Interface Rear Panel:

SIGNAL OUTPUT

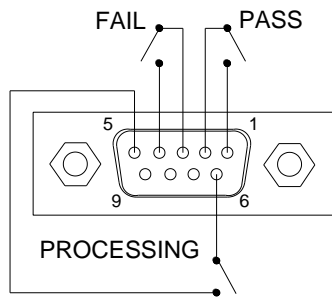

SIGNAL INPUT

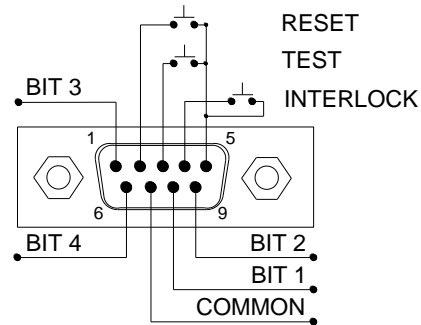

With the Hardware Interlock in place, the standard interlock is hard wired into the HV control relay that connects the amplifier board to the high voltage output. In the event that the interlock is interrupted, the relay connected to the high voltage transformer will open dropping the voltage on the output to zero. This also makes an interlock disable possible in the event that the CPU is interrupted. If the link from the standard interlock to the CPU fails or the CPU itself fails, the direct hardware link ensures that high voltage will be shut off.

58 Disable RUN/LLT GFI (8206, 8207, 8256, 8257)

With this option installed the instrument will not detect RUN or LLT, DUT GFI failures. All other specifications remain the same. Refer to the Specifications section of OMNIA II Operation and Service Manual, for a complete list of all specifications.

9. FAILCHEK

FailCHEK is the process by which an instrument's failure detectors are proven to be functioning properly. Verifying the failure detection circuitry of the electrical safety tester is required by safety agencies such as CSA, UL, and TÜV.

- **NOTE:** Verification should be performed at the beginning of each day or each shift, before testing has begun.

9.1. FAILCHEK Menu

From the Main Menu press the FailCHEK button.

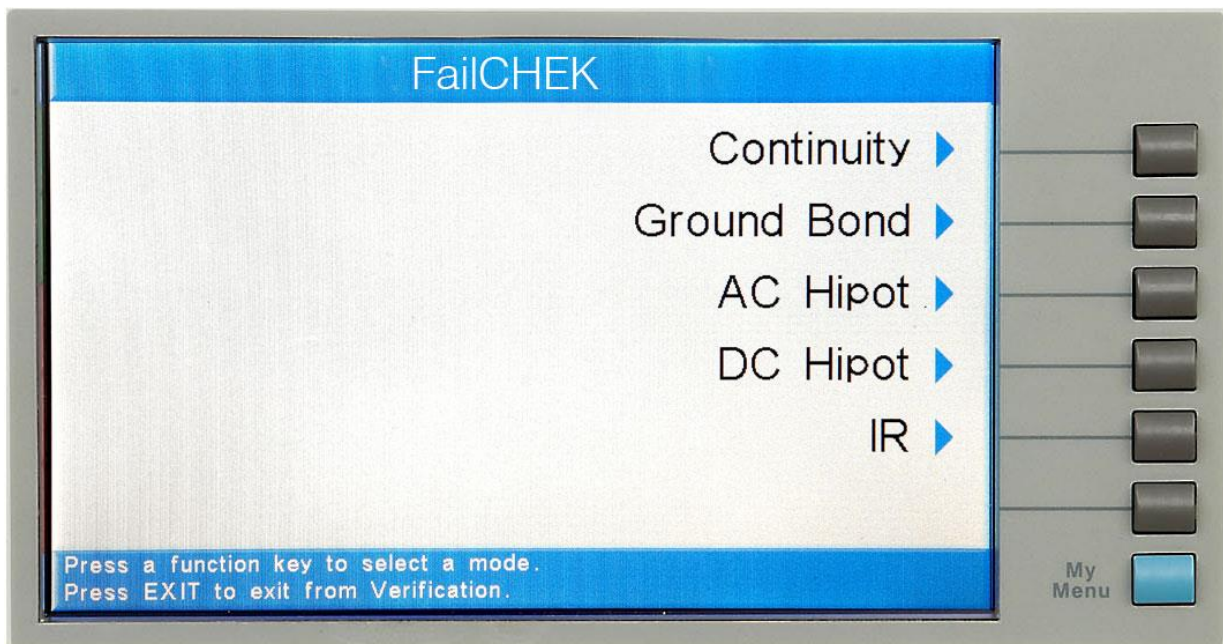

The FailCHEK Menu screen will now be displayed. From the FailCHEK Menu screen, five different Verification processes may be accessed: Continuity, Ground Bond, AC Hipot, DC Hipot, and IR.

9.1.1. Continuity Verification

From the FailCHEK screen, press the "Continuity" soft key. A pop-up message will now be displayed. The message will appear as follows:

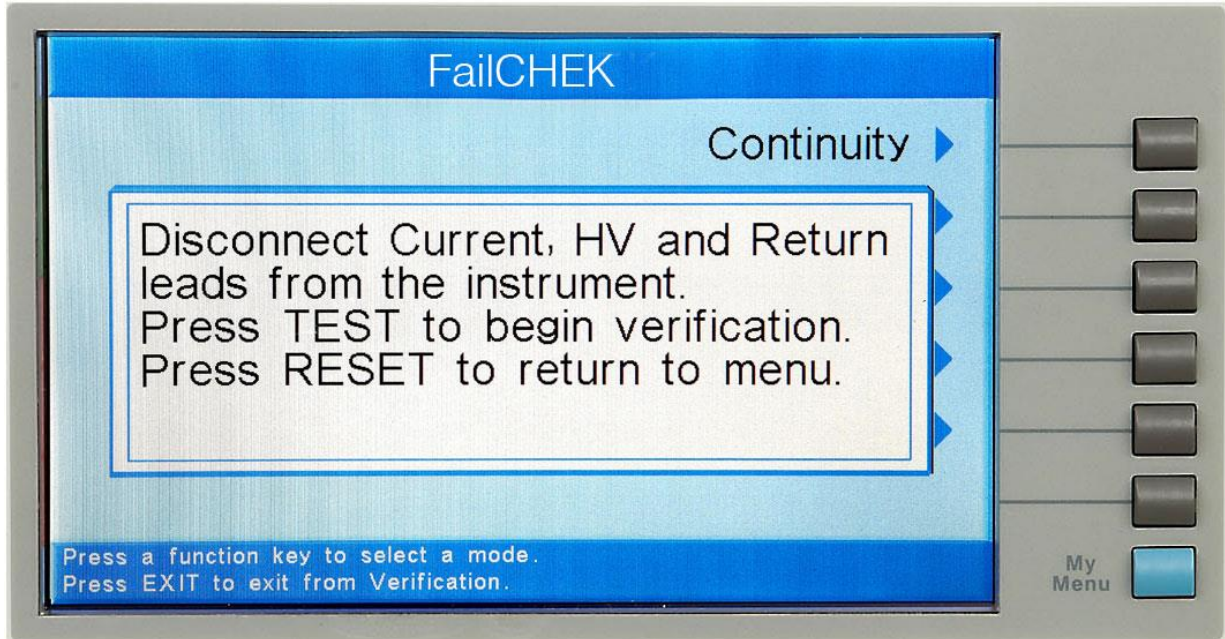

Follow the instructions given in the pop-up message and then press TEST to begin the verification process. During the Verification process, the metering screen for the related process will be displayed. Refer to section **5.4. Perform Tests Metering** for more information.

At the end of the Verification process, a pop-up message will appear indicating the outcome of the process. If the instrument passes the Verification (test failure, indicating the fail detectors are working properly) the RESET button will illuminate, the alarm will sound and the following pop-up message will appear over the metering screen:

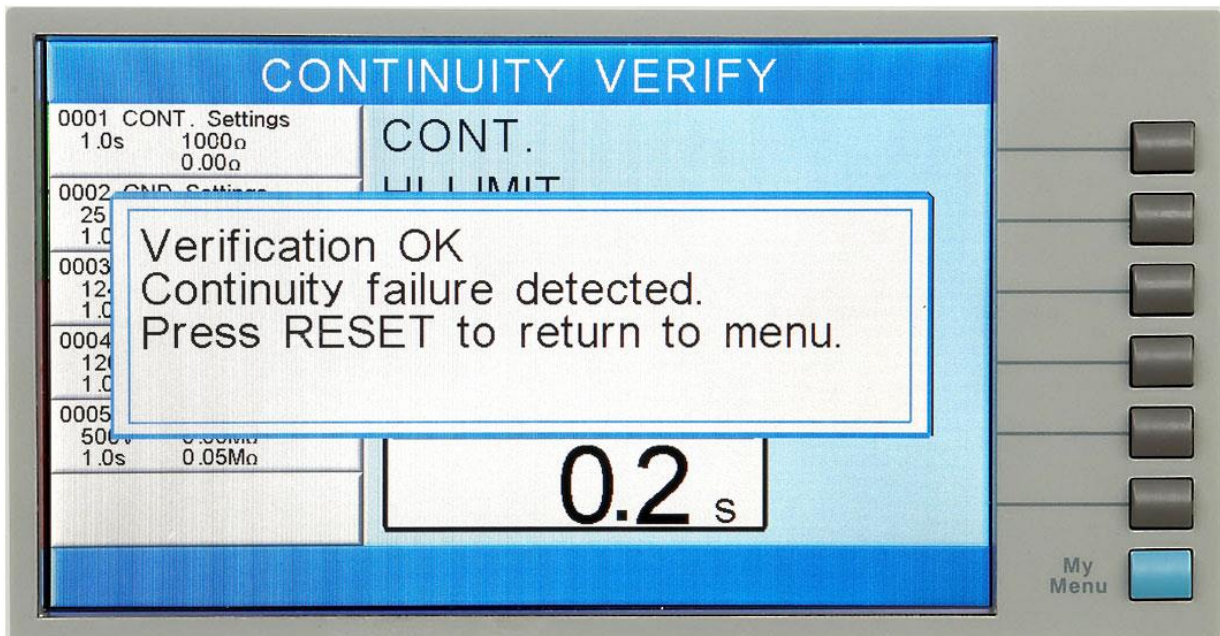

If the instrument fails the Verification (test pass, indicating the fail detectors are not working properly) the TEST button will illuminate and the following pop-up message will appear over the metering screen:

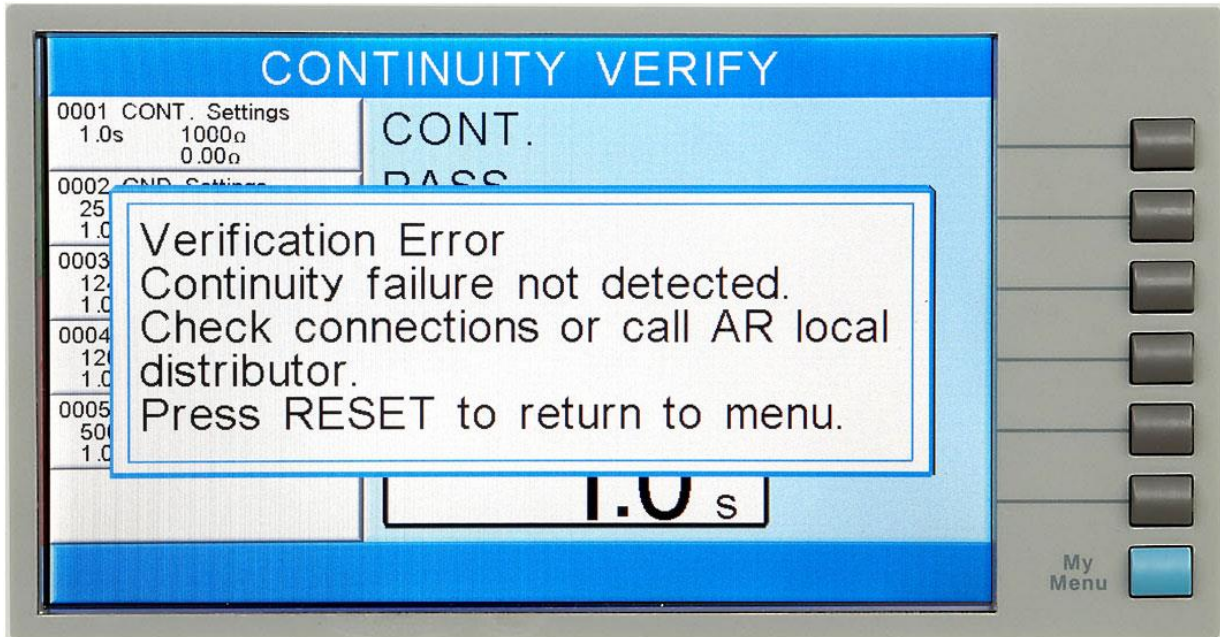

9.1.2. Ground Bond Verification

From the FailCHEK screen, press the "Ground Bond" soft key. A pop-up message will now be displayed. The message will appear as follows:

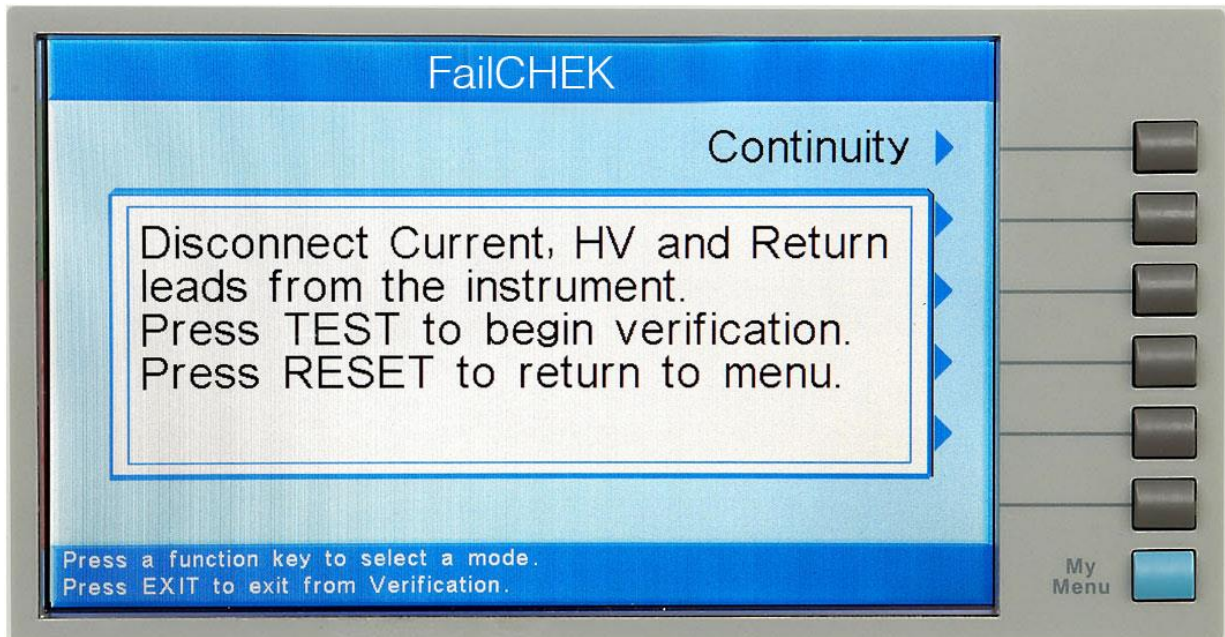

Follow the instructions given in the pop-up message and then press TEST to begin the verification process. During the Verification process the metering screen for the related process will be displayed, refer to section 5.4. **Perform Tests Metering for**

more information.

At the end of the Verification process, a pop-up message will appear indicating the outcome of the process. If the instrument passes the Verification (test failure, indicating the fail detectors are working properly) the RESET button will illuminate, the alarm will sound and the following pop-up message will appear over the metering screen:

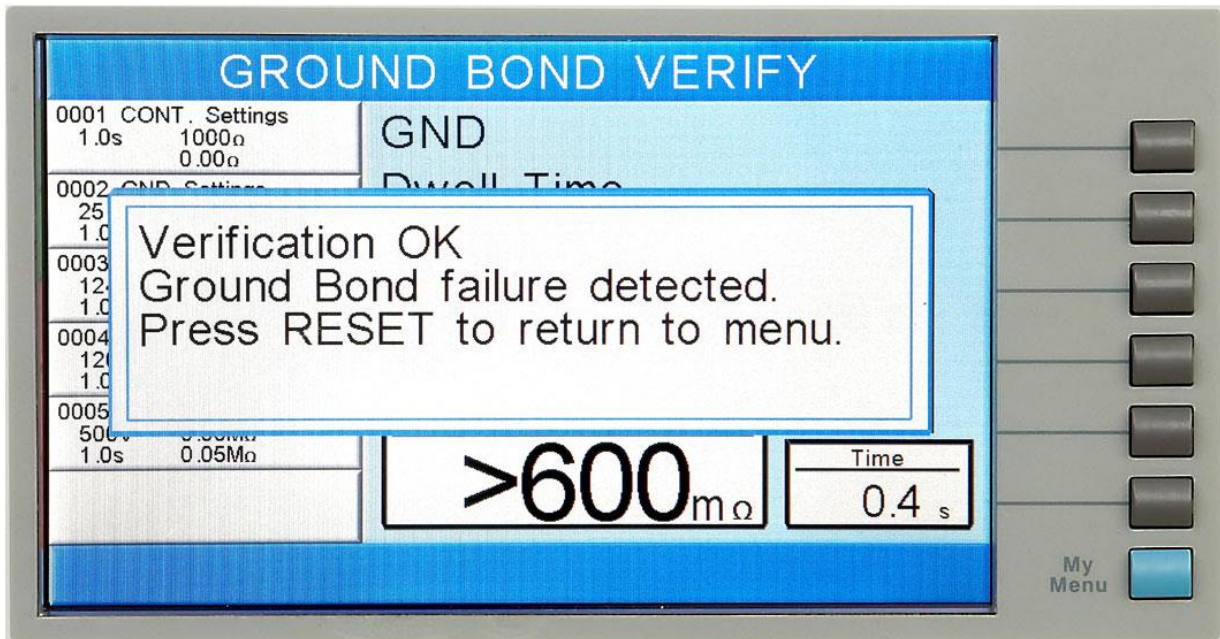

If the instrument fails the Verification (test pass, indicating the fail detectors are not working properly) the TEST button will illuminate and the following pop-up message will appear over the metering screen:

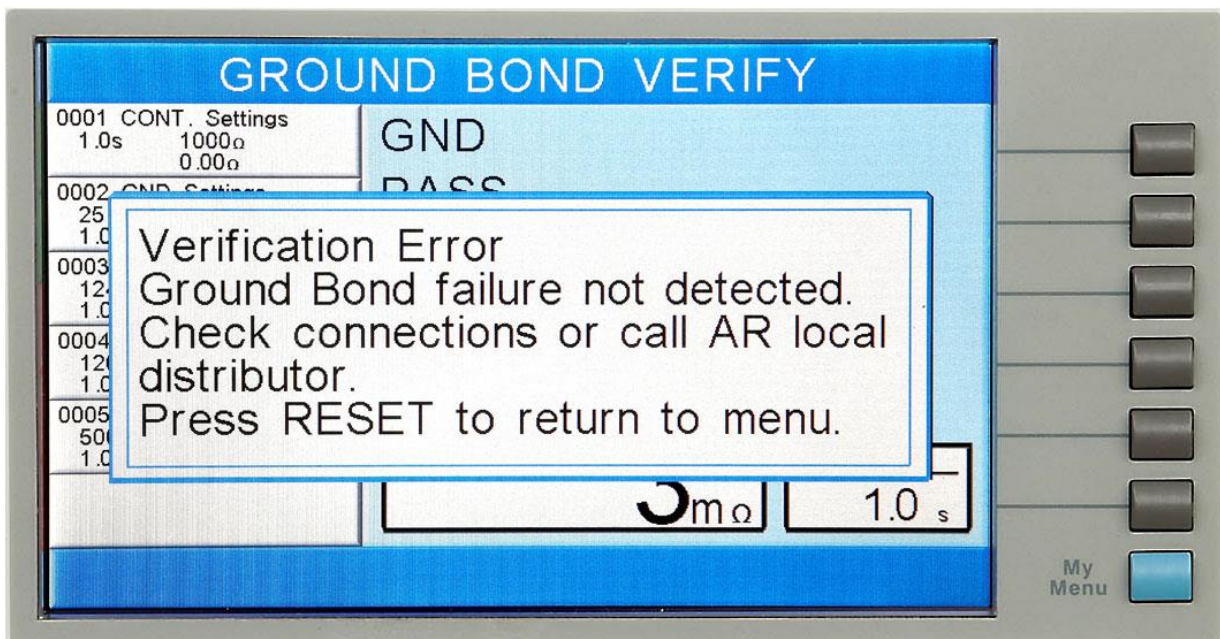

9.1.3. AC Hipot Verification

From the FailCHEK screen, press the “AC Hipot” soft key. A pop-up message will now be displayed. The message will appear as follows:

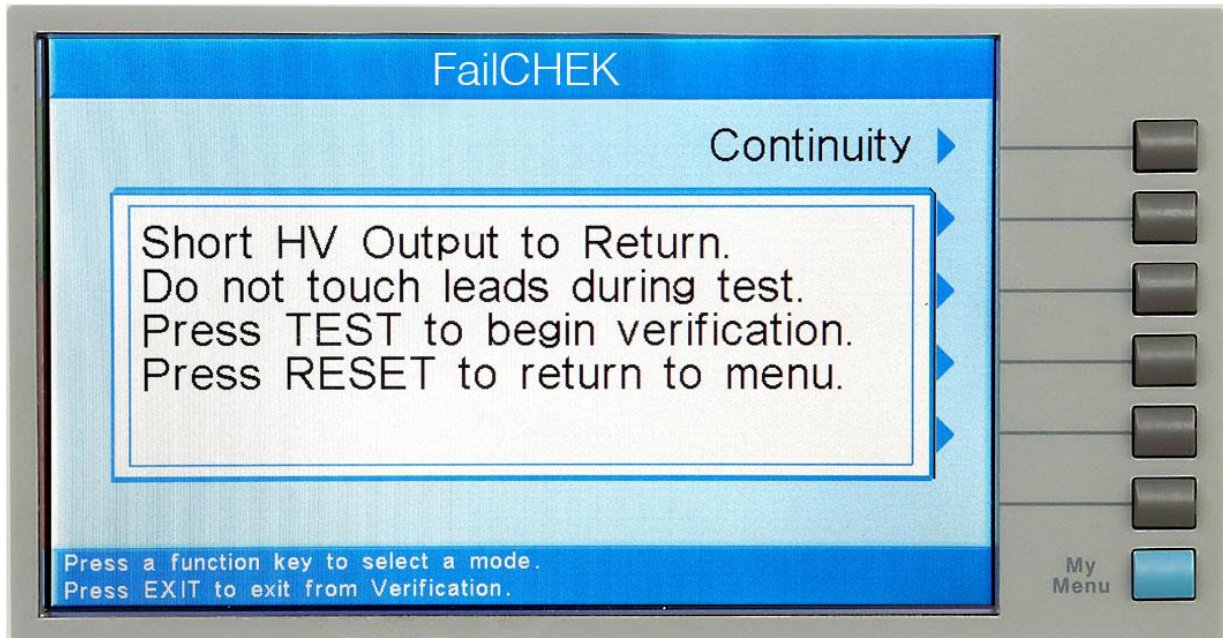

Follow the instructions given in the pop-up message and then press TEST to begin the verification process. During the Verification process the metering screen for the related process will be displayed, refer to section **5.4. Perform Tests Metering** for more information.

At the end of the Verification process, a pop-up message will appear indicating the outcome of the process. If the instrument passes the Verification (test failure, indicating the fail detectors are working properly) the RESET button will illuminate, the alarm will sound and the following pop-up message will appear over the metering screen:

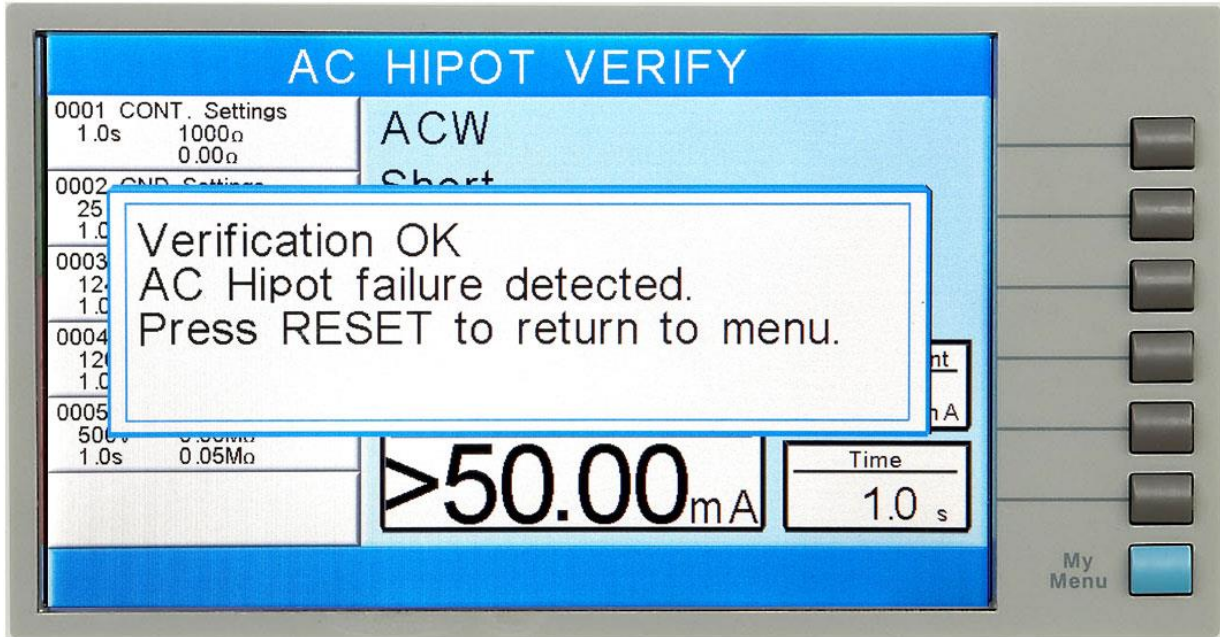

If the instrument fails the Verification (test pass, indicating the fail detectors are not working properly) the TEST button will illuminate and the following pop-up message will appear over the metering screen:

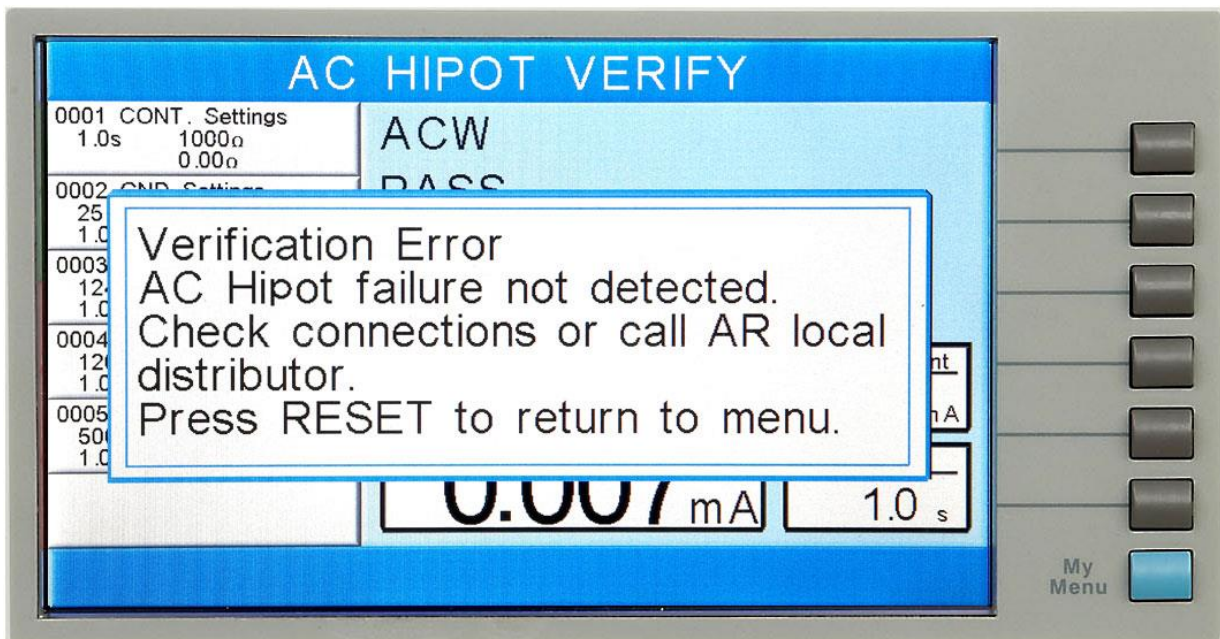

9.1.4. DC Hipot Verification

From the FailCHEK screen, press the "DC Hipot" soft key. A pop-up message will now be displayed. The message will appear as follows:

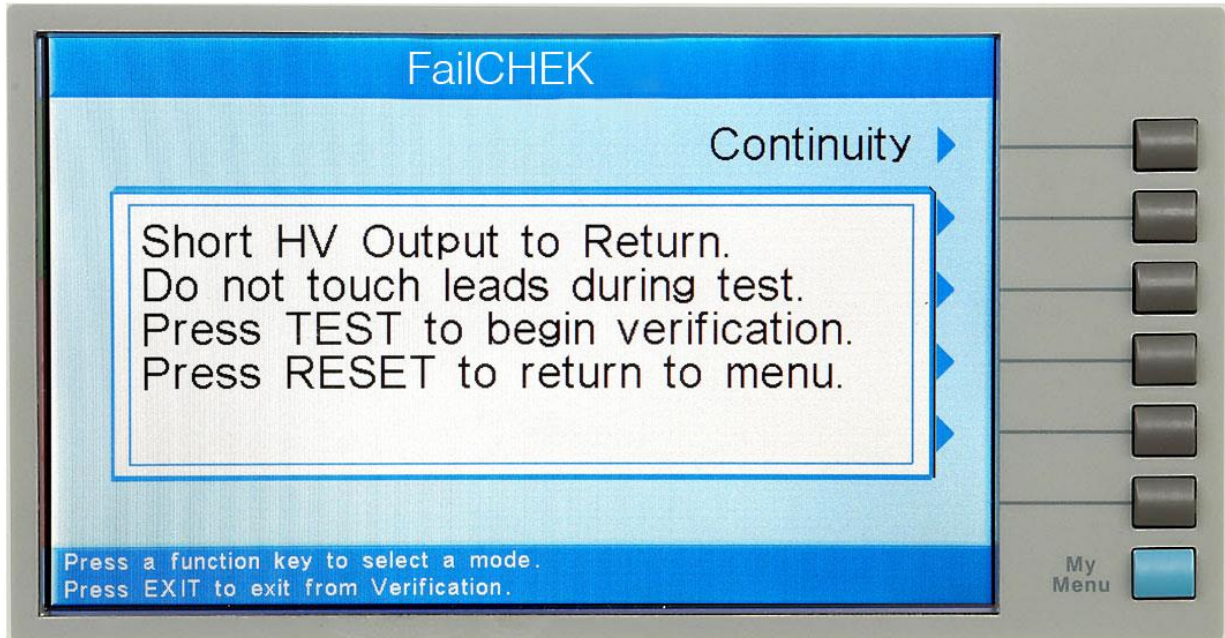

Follow the instructions given in the pop-up message and then press TEST to begin the verification process. During the Verification process the metering screen for the related process will be displayed, refer to section **5.4. Perform Tests Metering** for more information.

At the end of the Verification process, a pop-up message will appear indicating the outcome of the process. If the instrument passes the Verification (test failure, indicating the fail detectors are working properly) the RESET button will illuminate, the alarm will sound and the following pop-up message will appear over the metering screen:

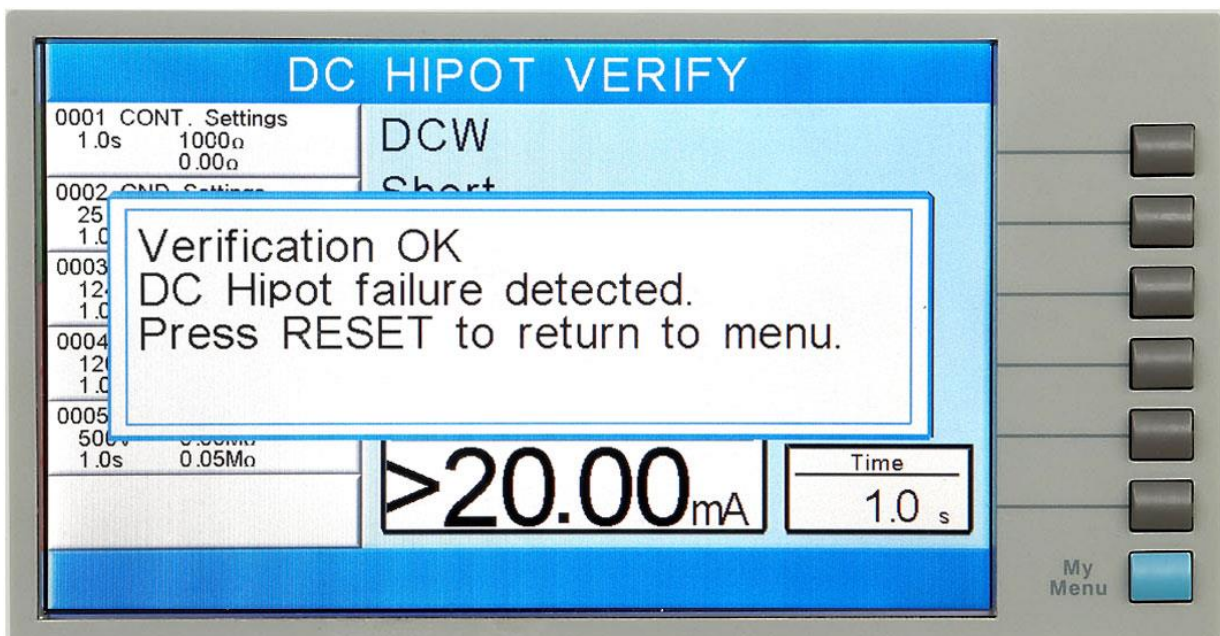

If the instrument fails the Verification (test pass, indicating the fail detectors are not working properly) the TEST button will illuminate and the following pop-up message will appear over the metering screen:

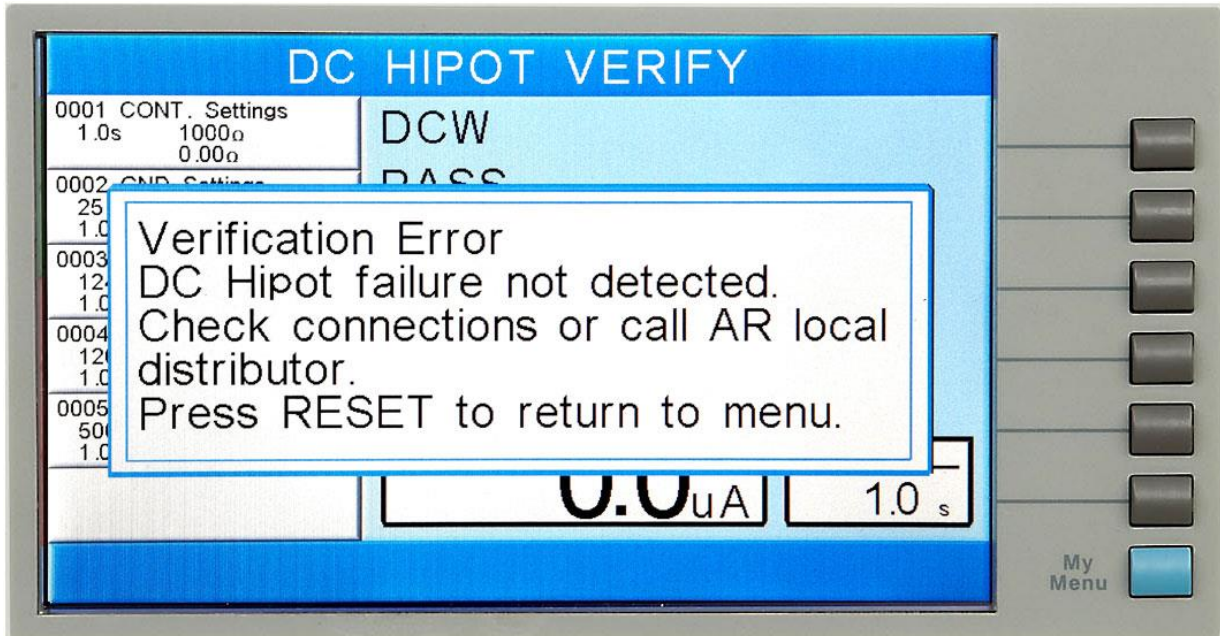

9.1.5. IR Verification

From the FailCHEK screen, press the "IR" soft key. A pop-up message will now be displayed. The message will appear as follows:

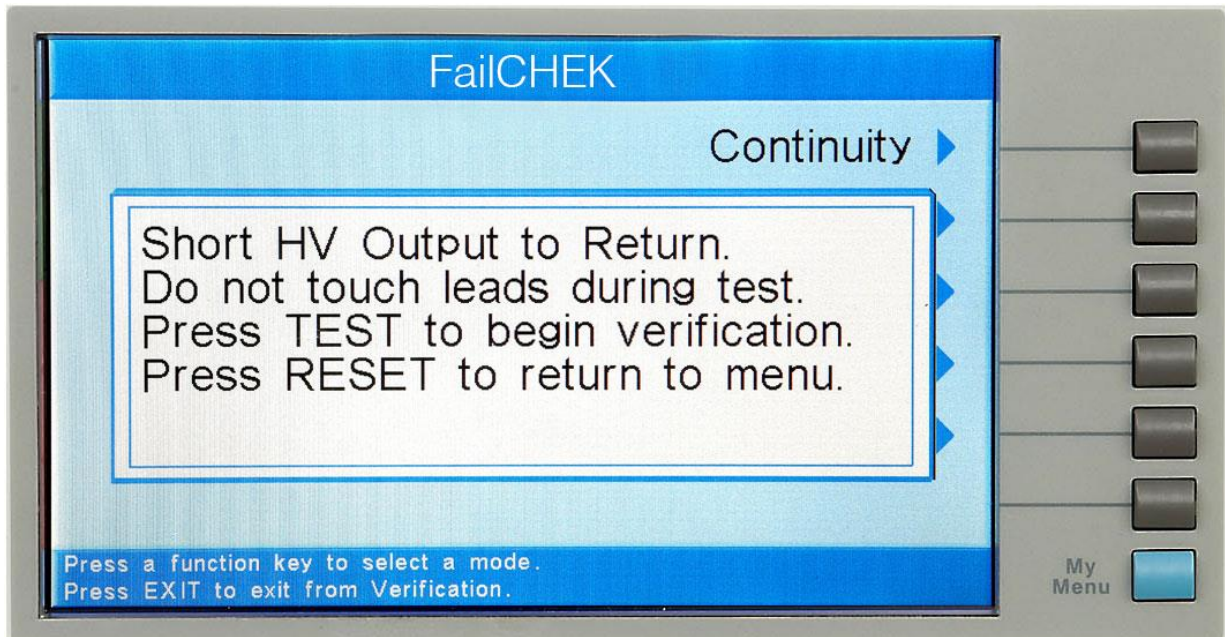

Follow the instructions given in the pop-up message and then press TEST to begin the verification process. During the Verification process the metering screen for the related process will be displayed, refer to section 5.4. **Perform Tests Metering for**

more information.

At the end of the Verification process, a pop-up message will appear indicating the outcome of the process. If the instrument passes the Verification (test failure, indicating the fail detectors are working properly) the RESET button will illuminate, the alarm will sound and the following pop-up message will appear over the metering screen:

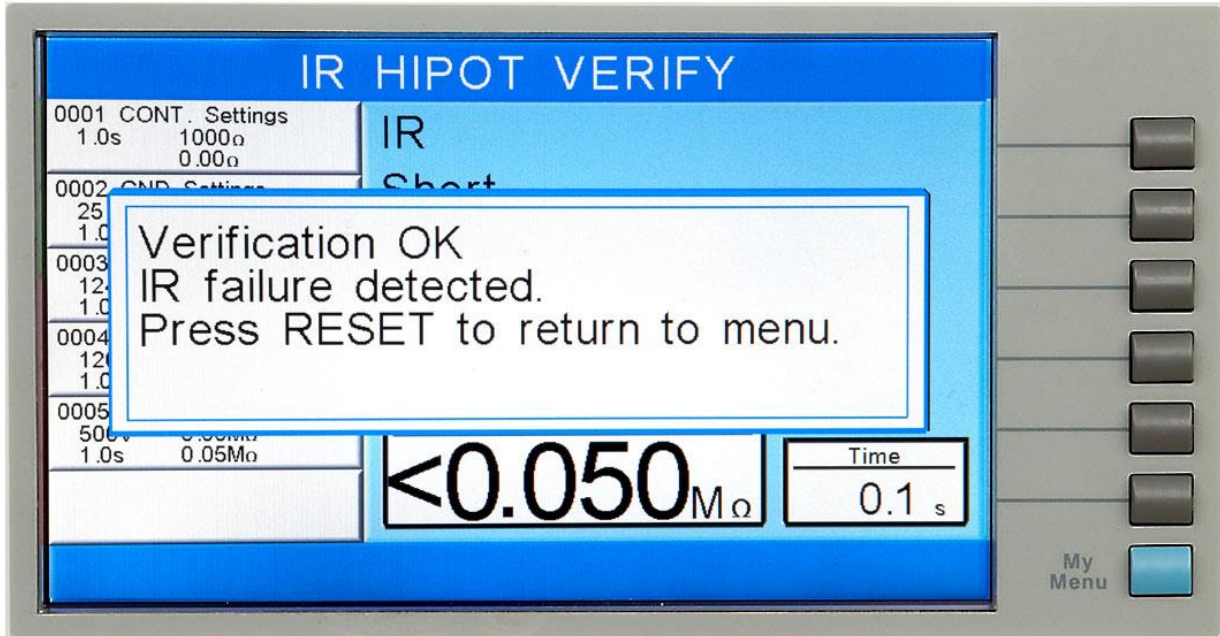

If the instrument fails the Verification (test pass, indicating the fail detectors are not working properly) the TEST button will illuminate and the following pop-up message will appear over the metering screen:



10. CALIBRATION PROCEDURE

DID YOU KNOW?

This instrument has been fully calibrated at the factory in accordance to our published specifications and with standards traceable to the National Institute of Standards & Technology (NIST).

You will find in this manual a copy of the "Certificate of Calibration". It is recommended that you have this instrument recertified at least once per year. Associated Research, Inc. recommends you use "Calibration Standards" that are NIST traceable or traceable to agencies recognized by NIST to keep this instrument within published specifications. Unless necessary, do not recalibrate the instrument within the first 12 months.

End user metrology standards or practices may vary. These metrology standards determine the measurement uncertainty ratio of the calibration standards being used. Calibration adjustments can only be made in the Calibration mode and calibration checks or verifications can only be made while operating in Test mode.

- **NOTE:** Verification should be performed before and after calibration. Calibration effects will only be noticeable after exiting calibration mode.

10.1. Warranty Requirements

Associated Research, Inc. offers a standard three-year manufacturer's warranty. This warranty can be extended an additional two years provided that the instrument is returned each year to Associated Research, Inc. for its annual recertification. In order to be eligible for the extended warranty instruments must be returned to Associated Research, Inc. for certification service at least once every twelve months.

A return material authorization number (RMA) must be obtained from Associated Research, Inc. before returning this instrument for calibration. To obtain an RMA number or for information regarding our warranty, please contact our customer support representatives at 1-800-858-TEST (8378) or setup an RMA online at <http://www.asresearch.com/support/RMA-request.aspx>.

Required Calibration Equipment

- 0 - 6 KV AC/DC Metered Voltage Divider
- 50 mA AC or 100 mA AC for 500VA models, 20 mA DC Ammeter
- 0 - 30 mV AC Millivoltmeter
- 30 AAC Current Shunt
- 10 Ω , 0.25 watt resistor, 250 volt
- 50M Ω , 0.25 watt resistor, 1000 volt
- 500M Ω , 0.25 watt resistor, 1000 volt
- 100K Ω , 175 watt resistor, 5000 volt
- 1M Ω , 20 watt resistor, 5000 volt
- Adjustable DC power supply, 0.032 volts to 20 volts

- Adjustable AC power supply 0-277 volts, 5KVA
- Low impedance adjustable load 10Ω-30Ω, 4000 watts

10.2. Hardware Calibration

This paragraph covers the hardware calibration procedure for the LCT Leakage 8.00mA – 10.00mA range. The hardware calibration is required to be performed prior to the standard software calibration of the LCT MD Volts x0.1 range only when the LAM board (LAM7800) is replaced. This is also true if the LCT Board (LCT7800) and LAM board (LAM 7800) are simultaneously replaced.

Required Measurement Standard:

- Wideband Voltmeter 100 kHz capable of measuring to 10 VAC
- Sine Wave Generator 100 Hz to 100 kHz capable

Procedure:

1. Connect the Probe-HI and Probe-LO leads to output of the Sine Wave Generator and in parallel with Wideband Voltmeter.
2. Select the LCT step and set Leakage-HI = 10.00mARMS in manual ranging mode with filter set to AC+DC, Dwell Time = 0.0s, Measuring Device to “Frequency Check”, and Probe configuration to “Probe-HI To Probe-LO”.
3. Set the output frequency of the Sine Wave Generator to 100 kHz.
4. Adjust output of the Sine Wave Generator to 10.00VRMS or to maximum that generator provides. To meet required accuracy the Voltage should be bigger than 5.00VRMS. Control the output voltage with the standard Wideband Voltmeter. Write down the RMS Leakage current that the OMNIA 2 meter indicates.
5. Change the output frequency of the Sine Wave Generator to 100 Hz and adjust the output voltage to the same value.
6. Adjust the VR1 on the OMNIA 2 to have the Leakage current as close as possible to the value recorded above.

10.3. Calibration Initialization

Press and hold the calibration key on the rear panel with a pen, pencil or small screwdriver while powering ON the OMNIA. The OMNIA enters calibration mode after the power on sequence is complete. The Initial Calibration screen will appear as follows:

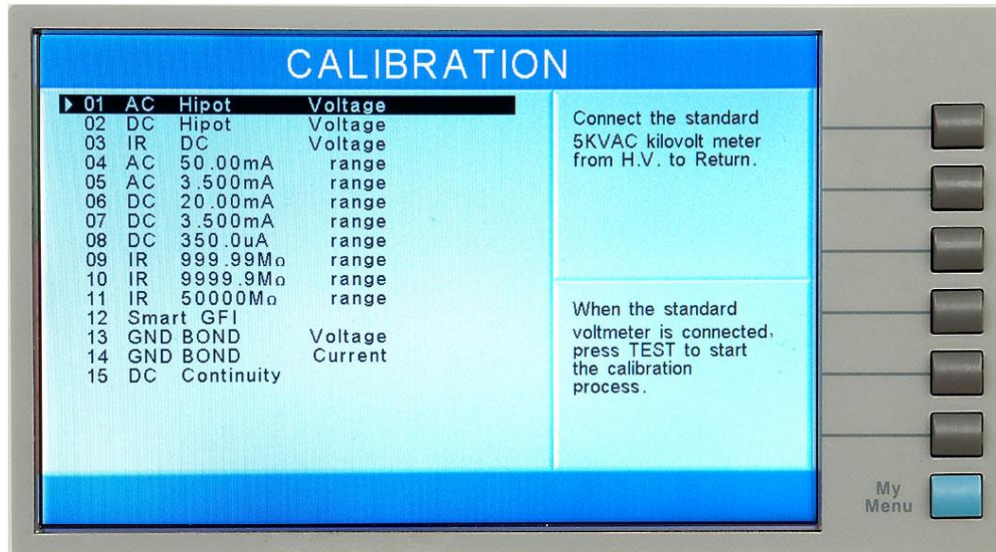

The Calibration screen is separated into three sections. The left half of the screen lists all of the calibration points necessary for an accurate calibration of the instrument. The right half of the screen is split into two smaller screens. The upper right section of the screen displays meter and load information required to perform the selected calibration. The lower right section of the screen contains prompts that will help guide you through the calibration process.

10.4. Selecting Specific Calibration points

When the calibration is initialized, the first calibration point is automatically selected. The calibration is set up so that as each calibration point is completed the highlighted area will automatically scroll to the next calibration point.

To manually select calibration points, use the up and down arrows to scroll the highlighted area to the desired calibration point. The load/meter screen and prompt screens will automatically update for the calibration point selected.

10.5. Calibration points

Each calibration point requires different loads, standards and process. As each point is selected, the load/meter screen and prompt screens will display the meter, load and process information required to complete the calibration process for the selected point.

Calibration of AC Hipot Voltage

The load/meter screen and prompt screens will contain the following text for this calibration point:

Upper Right Screen Load/Meter	Lower Right Screen Prompt	Lower Right Screen Prompt (Cal. Active)
Connect the standard 5KVAC kilovolt meter from H.V. to Return.	When the standard voltmeter is connected, press TEST to start the calibration process.	Enter Standard Voltage Reading.

Press the TEST button to activate the calibration. After the calibration is activated, the lower right screen will change to the text indicated in the table above (**Cal. Active**). Read the measurement from your standard and enter it using the numeric keypad. You may now store the new calibration number by pressing the ENTER key or escape by pressing the EXIT key or the RESET button.

Calibration of DC Hipot Voltage

The load/meter screen and prompt screens will contain the following text for this calibration point:

Upper Right Screen Load/Meter	Lower Right Screen Prompt	Lower Right Screen Prompt (Cal. Active)
Connect the standard 6KVDC kilovolt meter from H.V. to Return.	When the standard voltmeter is connected, press TEST to start the calibration process.	Enter Standard Voltage Reading.

Press the TEST button to activate the calibration. After the calibration is activated, the lower right screen will change to the text indicated in the table above (**Cal. Active**). Read the measurement from your standard and enter it using the numeric keypad. You may now store the new calibration number by pressing the ENTER key or escape by pressing the EXIT key or the RESET button.

Calibration of IR DC Voltage

The load/meter screen and prompt screens will contain the following text for this calibration point:

Upper Right Screen Load/Meter	Lower Right Screen Prompt	Lower Right Screen Prompt (Cal. Active)
Connect the standard 1KVDC kilovolt meter from H.V. to Return.	When the standard voltmeter is connected, press TEST to start the calibration process.	Enter Standard Voltage Reading.

Press the TEST button to activate the calibration. After the calibration is activated, the lower right screen will change to the text indicated in the table above (**Cal. Active**).

Read the measurement from your standard and enter it using the numeric keypad. You may now store the new calibration number by pressing the ENTER key or escape by pressing the EXIT key or the RESET button.

Calibration of AC 50mA Range (100mA Range for 500VA models)

The load/meter screen and prompt screens will contain the following text for this calibration point:

Upper Right Screen Load/Meter	Lower Right Screen Prompt	Lower Right Screen Prompt (Cal. Active)
Connect the 100K Ω load in series with the 50mAAC (100mAAC for 500VA models) standard current meter.	When the load is connected, press TEST to start the calibration process.	Enter Standard Current Reading.

Press the TEST button to activate the calibration. After the calibration is activated, the lower right screen will change to the text indicated in the table above (**Cal. Active**). Read the measurement from your standard and enter it using the numeric keypad. You may now store the new calibration number by pressing the ENTER key or escape by pressing the EXIT key or the RESET button.

Calibration of AC 3.5mA Range

The load/meter screen and prompt screens will contain the following text for this calibration point:

Upper Right Screen Load/Meter	Lower Right Screen Prompt	Lower Right Screen Prompt (Cal. Active)
Connect the 100K Ω load in series with the 3.5mAAC standard current meter.	When the load is connected, press TEST to start the calibration process.	Enter Standard Current Reading.

Press the TEST button to activate the calibration. After the calibration is activated, the lower right screen will change to the text indicated in the table above (**Cal. Active**). Read the measurement from your standard and enter it using the numeric keypad. You may now store the new calibration number by pressing the ENTER key or escape by pressing the EXIT key or the RESET button.

Calibration of DC 20mA Range

The load/meter screen and prompt screens will contain the following text for this calibration point:

Upper Right Screen Load/Meter	Lower Right Screen Prompt	Lower Right Screen Prompt (Cal. Active)
Connect the 100K Ω load in series with the 20mADC standard current meter from H.V. to Return.	When the load is connected, press TEST to start the calibration process.	Enter Standard Current Reading.

Press the TEST button to activate the calibration. After the calibration is activated, the lower right screen will change to the text indicated in the table above (**Cal. Active**). Read the measurement from your standard and enter it using the numeric keypad. You may now store the new calibration number by pressing the ENTER key or escape by pressing the EXIT key or the RESET button.

Calibration of DC 3.5mA Range

The load/meter screen and prompt screens will contain the following text for this calibration point:

Upper Right Screen Load/Meter	Lower Right Screen Prompt	Lower Right Screen Prompt (Cal. Active)
Connect the 100K Ω load in series with the 3.5mADC standard current meter from H.V. to Return.	When the load is connected, press TEST to start the calibration process.	Enter Standard Current Reading.

Press the TEST button to activate the calibration. After the calibration is activated, the lower right screen will change to the text indicated in the table above (**Cal. Active**). Read the measurement from your standard and enter it using the numeric keypad. You may now store the new calibration number by pressing the ENTER key or escape by pressing the EXIT key or the RESET button.

Calibration of DC 350.0 μ A Range

The load/meter screen and prompt screens will contain the following text for this calibration point:

Upper Right Screen Load/Meter	Lower Right Screen Prompt	Lower Right Screen Prompt (Cal. Active)
Connect the 100K Ω load in series with the 350.0 μ ADC standard current meter from H.V. to Return.	When the load is connected, press TEST to start the calibration process.	Enter Standard Current Reading.

Press the TEST button to activate the calibration. After the calibration is activated, the lower right screen will change to the text indicated in the table above (**Cal. Active**). Read the measurement from your standard and enter it using the numeric keypad.

You may now store the new calibration number by pressing the ENTER key or escape by pressing the EXIT key or the RESET button.

Calibration of IR 999.99M Range

The load/meter screen and prompt screens will contain the following text for this calibration point:

Upper Right Screen Load/Meter	Lower Right Screen Prompt	Lower Right Screen Prompt (Cal. Active)
Connect the standard 50M Ω load from H.V. to Return.	When the standard load is connected, press TEST to start the calibration process.	Automatic Calibration Processing.

Press the TEST button to activate the calibration. After the calibration is activated, the lower right screen will change to the text indicated in the table above (**Cal. Active**). This calibration is automatic and does not require data entry.

Calibration of IR 9999.9M Range

The load/meter screen and prompt screens will contain the following text for this calibration point:

Upper Right Screen Load/Meter	Lower Right Screen Prompt	Lower Right Screen Prompt (Cal. Active)
Connect the standard 50M Ω load from H.V. to Return.	When the standard load is connected, press TEST to start the calibration process.	Automatic Calibration Processing.

Press the TEST button to activate the calibration. After the calibration is activated, the lower right screen will change to the text indicated in the table above (**Cal. Active**). This calibration is automatic and does not require data entry.

Calibration of IR 50000M Range

The load/meter screen and prompt screens will contain the following text for this calibration point:

Upper Right Screen Load/Meter	Lower Right Screen Prompt	Lower Right Screen Prompt (Cal. Active)
Connect the standard 500M Ω load from H.V. to Return.	When the standard load is connected, press TEST to start the calibration process.	Automatic Calibration Processing.

Press the TEST button to activate the calibration. After the calibration is activated, the lower right screen will change to the text indicated in the table above (**Cal. Active**). This calibration is automatic and does not require data entry.

Calibration of Smart GFI

The load/meter screen and prompt screens will contain the following text for this calibration point:

Upper Right Screen Load/Meter	Lower Right Screen Prompt	Lower Right Screen Prompt (Cal. Active)
Connect the standard 200k Ω with the 5mAAC standard current meter from H.V. to Case.	When the standard load is connected, press TEST to start the calibration process.	Enter Standard Current Reading.

Press the TEST button to activate the calibration. After the calibration is activated, the lower right screen will change to the text indicated in the table above (**Cal. Active**). Read the measurement from your standard and enter it using the numeric keypad. You may now store the new calibration number by pressing the ENTER key or escape by pressing the EXIT key or the RESET button.

Calibration of GND Bond Voltage

The load/meter screen and prompt screens will contain the following text for this calibration point:

Upper Right Screen Load/Meter	Lower Right Screen Prompt	Lower Right Screen Prompt (Cal. Active)
Short the Current and Return leads together	When the leads are shorted, press TEST to start the Calibration process.	Enter Standard Voltage Reading.

Press the TEST button to activate the calibration. After the calibration is activated, the lower right screen will change to the text indicated in the table above (**Cal. Active**). Read the measurement from your standard and enter it using the numeric keypad. You may now store the new calibration number by pressing the ENTER key or escape by pressing the EXIT key or the RESET button.

Calibration of GND Bond Current

The load/meter screen and prompt screens will contain the following text for this calibration point:

Upper Right Screen Load/Meter	Lower Right Screen Prompt	Lower Right Screen Prompt (Cal. Active)
Connect the standard 40AAC current meter from Current to Return.	When the standard current meter is connected, press TEST to start the calibration process.	Enter Standard Current Reading.

Press the TEST button to activate the calibration. After the calibration is activated, the

lower right screen will change to the text indicated in the table above (**Cal. Active**). Read the measurement from your standard and enter it using the numeric keypad. You may now store the new calibration number by pressing the ENTER key or escape by pressing the EXIT key or the RESET button.

Calibration of DC Continuity

The load/meter screen and prompt screens will contain the following text for this calibration point:

Upper Right Screen Load/Meter	Lower Right Screen Prompt	Lower Right Screen Prompt (Cal. Active)
Step 1: Short the Current and Return leads together.	When the leads are shorted, press TEST to start the calibration process.	Automatic Calibration Processing.
Step 2: Connect the standard 10Ω load from Current to Return.	When the load is connected, press TEST to start the calibration process.	Automatic Calibration Processing.
Step 3: Connect the standard 100Ω load from Current to Return.	When the load is connected, press TEST to start the calibration process.	Automatic Calibration Processing.
Step 4: Connect the standard 1000Ω load from Current to Return.	When the load is connected, press TEST to start the calibration process.	Automatic Calibration Processing.
Step 5: Connect the standard 10000Ω load from Current to Return.	When the load is connected, press TEST to start the calibration process.	Automatic Calibration Processing.

Press the TEST button to activate the calibration. After the calibration is activated, the lower right screen will change to the text indicated in the table above (**Cal. Active**). This calibration is automatic and does not require data entry.

Calibration of Run Test Voltage

The load/meter screen and prompt screens will contain the following text for this calibration point:

Upper Right Screen Load/Meter	Lower Right Screen Prompt	Lower Right Screen Prompt (Cal. Active)
Step 1: Disconnect power to the DUT I/P input.	With the DUT I/P input open, press TEST to start the calibration process.	Automatic Calibration Processing.
Step 2: Connect 250VAC and a standard voltmeter to the DUT I/P input.	Press TEST to start the calibration process.	Enter Standard Voltage Reading.

Press the TEST button to activate the calibration. After the calibration is activated, the lower right screen will change to the text indicated in the table above (**Cal. Active**). Read the measurement from your standard and enter it using the numeric keypad. You may now store the new calibration number by pressing the ENTER key or escape by pressing the EXIT key or the RESET button.

Calibration of Run Test Current

The load/meter screen and prompt screens will contain the following text for this calibration point:

Upper Right Screen Load/Meter	Lower Right Screen Prompt	Lower Right Screen Prompt (Cal. Active)
Set DUT I/P 120-277VAC. Connect a 15 Amp load at DUT output in series with current meter.	When the load is connected, press TEST to start the calibration process.	Enter Standard Current Reading.

Press the TEST button to activate the calibration. After the calibration is activated, the lower right screen will change to the text indicated in the table above (**Cal. Active**). Read the measurement from your standard and enter it using the numeric keypad. You may now store the new calibration number by pressing the ENTER key or escape by pressing the EXIT key or the RESET button.

Calibration of Run Test Power

The load/meter screen and prompt screens will contain the following text for this calibration point:

Upper Right Screen Load/Meter	Lower Right Screen Prompt	Lower Right Screen Prompt (Cal. Active)
Set DUT I/P voltage to 220VAC. Connect a 25Ω load. Connect power meter in series with the DUT.	When the load is connected, press TEST to start the calibration process.	Enter Standard Power Reading.

Press the TEST button to activate the calibration. After the calibration is activated, the lower right screen will change to the text indicated in the table above (**Cal. Active**). Read the measurement from your standard and enter it using the numeric keypad. You may now store the new calibration number by pressing the ENTER key or escape by pressing the EXIT key or the RESET button.

Calibration of Run Test Leakage

The load/meter screen and prompt screens will contain the following text for this calibration point:

Upper Right Screen Load/Meter	Lower Right Screen Prompt	Lower Right Screen Prompt (Cal. Active)
Connect 18 VAC supply to the DUT I/P input. Connect a standard current meter to the DUT outputs from L to G.	When the power supply and meter are connected, press TEST to start the calibration process.	Enter Standard Current Reading.

Press the TEST button to activate the calibration. After the calibration is activated, the lower right screen will change to the text indicated in the table above (**Cal. Active**). Read the measurement from your standard and enter it using the numeric keypad. You may now store the new calibration number by pressing the ENTER key or escape by pressing the EXIT key or the RESET button.

Calibration of LCT MD V-Offset

The load/meter screen and prompt screens will contain the following text for this calibration point:

Upper Right Screen Load/Meter	Lower Right Screen Prompt	Lower Right Screen Prompt (Cal. Active)
Disconnect power to the DUT I/P input.	When the leads are disconnected, press TEST to start the calibration process.	Automatic Calibration Processing.

Press the TEST button to activate the calibration. After the calibration is activated, the lower right screen will change to the text indicated in the table above (**Cal. Active**). This calibration is automatic and does not require data entry.

Calibration of LCT MD Volts DC x 0.1

The load/meter screen and prompt screens will contain the following text for this calibration point:

Upper Right Screen Load/Meter	Lower Right Screen Prompt	Lower Right Screen Prompt (Cal. Active)
Connect 20.0VDC and a voltmeter to Probe-HI + and Probe-LO -.	When the power supply and meter are connected, press TEST to start the calibration.	Enter Standard Voltage Reading.

Press the TEST button to activate the calibration. After the calibration is activated, the lower right screen will change to the text indicated in the table above (**Cal. Active**). Read the measurement from your standard and enter it using the numeric keypad. You may now store the new calibration number by pressing the ENTER key or escape by pressing the EXIT key or the RESET button.

Calibration of LCT MD Volts DC x 1

The load/meter screen and prompt screens will contain the following text for this calibration point:

Upper Right Screen Load/Meter	Lower Right Screen Prompt	Lower Right Screen Prompt (Cal. Active)
Connect 8.0VDC and a voltmeter to Probe-HI + and Probe-LO -.	When the power supply and meter are connected, press TEST to start the calibration.	Enter Standard Voltage Reading.

Press the TEST button to activate the calibration. After the calibration is activated, the lower right screen will change to the text indicated in the table above (**Cal. Active**). Read the measurement from your standard and enter it using the numeric keypad. You may now store the new calibration number by pressing the ENTER key or escape by pressing the EXIT key or the RESET button.

Calibration of LCT MD Volts DC x 4

The load/meter screen and prompt screens will contain the following text for this calibration point:

Upper Right Screen Load/Meter	Lower Right Screen Prompt	Lower Right Screen Prompt (Cal. Active)
Connect 2.0VDC and a voltmeter to Probe-HI + and Probe-LO -.	When the power supply and meter are connected, press TEST to start the calibration.	Enter Standard Voltage Reading.

Press the TEST button to activate the calibration. After the calibration is activated, the lower right screen will change to the text indicated in the table above (**Cal. Active**).

Read the measurement from your standard and enter it using the numeric keypad. You may now store the new calibration number by pressing the ENTER key or escape by pressing the EXIT key or the RESET button.

Calibration of LCT MD Volts DC x 16

The load/meter screen and prompt screens will contain the following text for this calibration point:

Upper Right Screen Load/Meter	Lower Right Screen Prompt	Lower Right Screen Prompt (Cal. Active)
Connect 0.5VDC and a voltmeter to Probe-HI + and Probe-LO -.	When the power supply and meter are connected, press TEST to start the calibration.	Enter Standard Voltage Reading.

Press the TEST button to activate the calibration. After the calibration is activated, the lower right screen will change to the text indicated in the table above (**Cal. Active**). Read the measurement from your standard and enter it using the numeric keypad. You may now store the new calibration number by pressing the ENTER key or escape by pressing the EXIT key or the RESET button.

Calibration of LCT MD Volts DC x 64

The load/meter screen and prompt screens will contain the following text for this calibration point:

Upper Right Screen Load/Meter	Lower Right Screen Prompt	Lower Right Screen Prompt (Cal. Active)
Connect 0.125VDC and a voltmeter to Probe-HI + and Probe-LO -.	When the power supply and meter are connected, press TEST to start the calibration.	Enter Standard Voltage Reading.

Press the TEST button to activate the calibration. After the calibration is activated, the lower right screen will change to the text indicated in the table above (**Cal. Active**). Read the measurement from your standard and enter it using the numeric keypad. You may now store the new calibration number by pressing the ENTER key or escape by pressing the EXIT key or the RESET button.

Calibration of LCT MD Volts DC x 256

The load/meter screen and prompt screens will contain the following text for this calibration point:

Upper Right Screen Load/Meter	Lower Right Screen Prompt	Lower Right Screen Prompt (Cal. Active)
Connect 0.032VDC and a voltmeter to Probe-HI + and Probe-LO -.	When the power supply and meter are connected, press TEST to start the calibration.	Enter Standard Voltage Reading.

Press the TEST button to activate the calibration. After the calibration is activated, the lower right screen will change to the text indicated in the table above (**Cal. Active**). Read the measurement from your standard and enter it using the numeric keypad. You may now store the new calibration number by pressing the ENTER key or escape by pressing the EXIT key or the RESET button.

Calibration of LCT MD Volts AC x 0.1

The load/meter screen and prompt screens will contain the following text for this calibration point:

Upper Right Screen Load/Meter	Lower Right Screen Prompt	Lower Right Screen Prompt (Cal. Active)
Connect 18.0VAC supply and a standard voltmeter to Probe-HI + and Probe-LO -.	When the power supply and meter are connected, press TEST to start the calibration.	Enter Standard Voltage Reading.

Press the TEST button to activate the calibration. After the calibration is activated, the lower right screen will change to the text indicated in the table above (**Cal. Active**). Read the measurement from your standard and enter it using the numeric keypad. You may now store the new calibration number by pressing the ENTER key or escape by pressing the EXIT key or the RESET button.

Calibration of LCT MD Volts AC Peak x 0.1

The load/meter screen and prompt screens will contain the following text for this calibration point:

Upper Right Screen Load/Meter	Lower Right Screen Prompt	Lower Right Screen Prompt (Cal. Active)
Connect 30.0Vp AC supply and a voltmeter to Probe-HI + and Probe-LO -.	When the power supply and meter are connected, press TEST to start the calibration.	Enter Standard Voltage Reading.

After the RMS value has been input, the lower right screen will change to the text indicated in the table above (**Cal. Active**). Read the measurement from your standard

and enter it using the numeric keypad. You may now store the new calibration number by pressing the ENTER key or escape by pressing the EXIT key or the RESET button.

Calibration of LCT MD Volts AC x 1

The load/meter screen and prompt screens will contain the following text for this calibration point:

Upper Right Screen Load/Meter	Lower Right Screen Prompt	Lower Right Screen Prompt (Cal. Active)
Connect 5.0VAC supply and a voltmeter to Probe-HI + and Probe-LO -.	When the power supply and meter are connected, press TEST to start the calibration.	Enter Standard Voltage Reading.

Press the TEST button to activate the calibration. After the calibration is activated, the lower right screen will change to the text indicated in the table above (**Cal. Active**). Read the measurement from your standard and enter it using the numeric keypad. You may now store the new calibration number by pressing the ENTER key or escape by pressing the EXIT key or the RESET button.

Calibration of LCT MD Volts AC Peak x 1

The load/meter screen and prompt screens will contain the following text for this calibration point:

Upper Right Screen Load/Meter	Lower Right Screen Prompt	Lower Right Screen Prompt (Cal. Active)
Connect 8.0Vp AC supply and a voltmeter to Probe-HI + and Probe-LO -.	When the power supply and meter are connected, press TEST to start the calibration.	Enter Standard Voltage Reading.

After the RMS value has been input, the lower right screen will change to the text indicated in the table above (**Cal. Active**). Read the measurement from your standard and enter it using the numeric keypad. You may now store the new calibration number by pressing the ENTER key or escape by pressing the EXIT key or the RESET button.

Calibration of LCT MD Volts AC x 4

The load/meter screen and prompt screens will contain the following text for this calibration point:

Upper Right Screen Load/Meter	Lower Right Screen Prompt	Lower Right Screen Prompt (Cal. Active)
Connect 1.25VAC supply and a voltmeter to Probe-HI + and Probe-LO -.	When the power supply and meter are connected, press TEST to start the calibration.	Enter Standard Voltage Reading.

Press the TEST button to activate the calibration. After the calibration is activated, the lower right screen will change to the text indicated in the table above (**Cal. Active**). Read the measurement from your standard and enter it using the numeric keypad. You may now store the new calibration number by pressing the ENTER key or escape by pressing the EXIT key or the RESET button.

Calibration of LCT MD Volts AC Peak x 4

The load/meter screen and prompt screens will contain the following text for this calibration point:

Upper Right Screen Load/Meter	Lower Right Screen Prompt	Lower Right Screen Prompt (Cal. Active)
Connect 2.0Vp AC supply and a voltmeter to Probe-HI + and Probe-LO -.	When the power supply and meter are connected, press TEST to start the calibration.	Enter Standard Voltage Reading.

After the RMS value has been input, the lower right screen will change to the text indicated in the table above (**Cal. Active**). Read the measurement from your standard and enter it using the numeric keypad. You may now store the new calibration number by pressing the ENTER key or escape by pressing the EXIT key or the RESET button.

Calibration of LCT MD Volts AC x 16

The load/meter screen and prompt screens will contain the following text for this calibration point:

Upper Right Screen Load/Meter	Lower Right Screen Prompt	Lower Right Screen Prompt (Cal. Active)
Connect 0.32VAC supply and a voltmeter to Probe-HI + and Probe-LO -.	When the power supply and meter are connected, press TEST to start the calibration.	Enter Standard Voltage Reading.

Press the TEST button to activate the calibration. After the calibration is activated, the lower right screen will change to the text indicated in the table above (**Cal. Active**).

Read the measurement from your standard and enter it using the numeric keypad. You may now store the new calibration number by pressing the ENTER key or escape by pressing the EXIT key or the RESET button.

Calibration of LCT MD Volts AC Peak x 16

The load/meter screen and prompt screens will contain the following text for this calibration point:

Upper Right Screen Load/Meter	Lower Right Screen Prompt	Lower Right Screen Prompt (Cal. Active)
Connect 0.5Vp AC supply and a voltmeter to Probe-HI + and Probe-LO -.	When the power supply and meter are connected, press TEST to start the calibration.	Enter Standard Voltage Reading.

After the RMS value has been input, the lower right screen will change to the text indicated in the table above (**Cal. Active**). Read the measurement from your standard and enter it using the numeric keypad. You may now store the new calibration number by pressing the ENTER key or escape by pressing the EXIT key or the RESET button.

Calibration of LCT MD Volts AC x 64

The load/meter screen and prompt screens will contain the following text for this calibration point:

Upper Right Screen Load/Meter	Lower Right Screen Prompt	Lower Right Screen Prompt (Cal. Active)
Connect 0.08VAC supply and a voltmeter to Probe-HI + and Probe-LO -.	When the power supply and meter are connected, press TEST to start the calibration.	Enter Standard Voltage Reading.

Press the TEST button to activate the calibration. After the calibration is activated, the lower right screen will change to the text indicated in the table above (**Cal. Active**). Read the measurement from your standard and enter it using the numeric keypad. You may now store the new calibration number by pressing the ENTER key or escape by pressing the EXIT key or the RESET button.

Calibration of LCT MD Volts AC Peak x 64

The load/meter screen and prompt screens will contain the following text for this calibration point:

Upper Right Screen Load/Meter	Lower Right Screen Prompt	Lower Right Screen Prompt (Cal. Active)
Connect 0.125Vp AC supply and a voltmeter to Probe-HI + and Probe-LO -.	When the power supply and meter are connected, press TEST to start the calibration.	Enter Standard Voltage Reading.

After the RMS value has been input, the lower right screen will change to the text indicated in the table above (**Cal. Active**). Read the measurement from your standard and enter it using the numeric keypad. You may now store the new calibration number by pressing the ENTER key or escape by pressing the EXIT key or the RESET button.

Calibration of LCT MD Volts AC x 256

The load/meter screen and prompt screens will contain the following text for this calibration point:

Upper Right Screen Load/Meter	Lower Right Screen Prompt	Lower Right Screen Prompt (Cal. Active)
Connect 0.02VAC supply and a voltmeter to Probe-HI + and Probe-LO -.	When the power supply and meter are connected, press TEST to start the calibration.	Enter Standard Voltage Reading.

Press the TEST button to activate the calibration. After the calibration is activated, the lower right screen will change to the text indicated in the table above (**Cal. Active**). Read the measurement from your standard and enter it using the numeric keypad. You may now store the new calibration number by pressing the ENTER key or escape by pressing the EXIT key or the RESET button.

Calibration of LCT MD Volts AC Peak x 256

The load/meter screen and prompt screens will contain the following text for this calibration point:

Upper Right Screen Load/Meter	Lower Right Screen Prompt	Lower Right Screen Prompt (Cal. Active)
Connect 0.03Vp AC supply and a voltmeter to Probe-HI + and Probe-LO -.	When the power supply and meter are connected, press TEST to start the calibration.	Enter Standard Voltage Reading.

After the RMS value has been input, the lower right screen will change to the text indicated in the table above (**Cal. Active**). Read the measurement from your standard

and enter it using the numeric keypad. You may now store the new calibration number by pressing the ENTER key or escape by pressing the EXIT key or the RESET button.

Calibration of LCT MD: UL 544NP Measuring Device

The load/meter screen and prompt screens will contain the following text for this calibration point:

Upper Right Screen Load/Meter	Lower Right Screen Prompt	Lower Right Screen Prompt (Cal. Active)
Connect 2.0VDC in series with a current meter to Probe-HI + and Probe-LO -.	When the power supply and meter are connected, press TEST to start the calibration.	Enter Standard Current Reading.

Press the TEST button to activate the calibration. After the calibration is activated, the lower right screen will change to the text indicated in the table above (**Cal. Active**). You may now store the new calibration number by pressing the ENTER key or escape by pressing the EXIT key or the RESET button.

Calibration of LCT MD: UL 544NP Measuring Device

The load/meter screen and prompt screens will contain the following text for this calibration point:

Upper Right Screen Load/Meter	Lower Right Screen Prompt	Lower Right Screen Prompt (Cal. Active)
Connect 2.0VDC in series with a current meter to Probe-HI + and Probe-LO -.	When the power supply and meter are connected, press TEST to start the calibration.	Enter Standard Current Reading.

Press the TEST button to activate the calibration. After the calibration is activated, the lower right screen will change to the text indicated in the table above (**Cal. Active**). Read the measurement from your standard and enter it using the numeric keypad. You may now store the new calibration number by pressing the ENTER key or escape by pressing the EXIT key or the RESET button.

Calibration of LCT MD: IEC60601-1 / UL2601 Measuring Device

The load/meter screen and prompt screens will contain the following text for this calibration point:

Upper Right Screen Load/Meter	Lower Right Screen Prompt	Lower Right Screen Prompt (Cal. Active)
Connect 2.0VDC in series with a current meter to Probe-HI + and Probe-LO -.	When the power supply and meter are connected, press TEST to start the calibration.	Enter Standard Current Reading.

Press the TEST button to activate the calibration. After the calibration is activated, the lower right screen will change to the text indicated in the table above (**Cal. Active**). Read the measurement from your standard and enter it using the numeric keypad. You may now store the new calibration number by pressing the ENTER key or escape by pressing the EXIT key or the RESET button.

Calibration of LCT MD: UL1563 Measuring Device

The load/meter screen and prompt screens will contain the following text for this calibration point:

Upper Right Screen Load/Meter	Lower Right Screen Prompt	Lower Right Screen Prompt (Cal. Active)
Connect 2.0VDC in series with a current meter to Probe-HI + and Probe-LO -.	When the power supply and meter are connected, press TEST to start the calibration.	Enter Standard Current Reading.

Press the TEST button to activate the calibration. After the calibration is activated, the lower right screen will change to the text indicated in the table above (**Cal. Active**). Read the measurement from your standard and enter it using the numeric keypad. You may now store the new calibration number by pressing the ENTER key or escape by pressing the EXIT key or the RESET button.

Calibration of LCT MD: IEC 60990 Fig4-U2 Measuring Device

The load/meter screen and prompt screens will contain the following text for this calibration point:

Upper Right Screen Load/Meter	Lower Right Screen Prompt	Lower Right Screen Prompt (Cal. Active)
Connect 2.0VDC in series with a current meter to Probe-HI + and Probe-LO -.	When the power supply and meter are connected, press TEST to start the calibration.	Enter Standard Current Reading.

Press the TEST button to activate the calibration. After the calibration is activated, the lower right screen will change to the text indicated in the table above (**Cal. Active**). Read the measurement from your standard and enter it using the numeric keypad. You may now store the new calibration number by pressing the ENTER key or escape by pressing the EXIT key or the RESET button.

Calibration of LCT MD: IEC 60990 Fig5-U3 Measuring Device

The load/meter screen and prompt screens will contain the following text for this calibration point:

Upper Right Screen Load/Meter	Lower Right Screen Prompt	Lower Right Screen Prompt (Cal. Active)
Connect 2.0VDC in series with a current meter to Probe-HI + and Probe-LO -.	When the power supply and meter are connected, press TEST to start the calibration.	Enter Standard Current Reading.

Press the TEST button to activate the calibration. After the calibration is activated, the lower right screen will change to the text indicated in the table above (**Cal. Active**). Read the measurement from your standard and enter it using the numeric keypad. You may now store the new calibration number by pressing the ENTER key or escape by pressing the EXIT key or the RESET button.

Calibration of LCT MD: External

The load/meter screen and prompt screens will contain the following text for this calibration point:

Upper Right Screen Load/Meter	Lower Right Screen Prompt	Lower Right Screen Prompt (Cal. Active)
Connect 2.0VDC in series with a current meter to Probe-HI + and Probe-LO -.	When the power supply and meter are connected, press TEST to start the calibration.	Enter Standard Current Reading.

Press the TEST button to activate the calibration. After the calibration is activated, the lower right screen will change to the text indicated in the table above (**Cal. Active**). Read the measurement from your standard and enter it using the numeric keypad. You may now store the new calibration number by pressing the ENTER key or escape by pressing the EXIT key or the RESET button.

Calibration of LCT MD: IEC60990 Fig4 Measuring Device

The load/meter screen and prompt screens will contain the following text for this calibration point:

Upper Right Screen Load/Meter	Lower Right Screen Prompt	Lower Right Screen Prompt (Cal. Active)
Connect 2.0VDC in series with a current meter to Probe-HI + and Probe-LO -.	When the power supply and meter are connected, press TEST to start the calibration.	Enter Standard Current Reading.

Press the TEST button to activate the calibration. After the calibration is activated, the lower right screen will change to the text indicated in the table above (**Cal. Active**).

Read the measurement from your standard and enter it using the numeric keypad. You may now store the new calibration number by pressing the ENTER key or escape by pressing the EXIT key or the RESET button.

Calibration of LCT MD: IEC60990 Fig5 Measuring Device

The load/meter screen and prompt screens will contain the following text for this calibration point:

Upper Right Screen Load/Meter	Lower Right Screen Prompt	Lower Right Screen Prompt (Cal. Active)
Connect 2.0VDC in series with a current meter to Probe-HI + and Probe-LO -.	When the power supply and meter are connected, press TEST to start the calibration.	Enter Standard Current Reading.

Press the TEST button to activate the calibration. After the calibration is activated, the lower right screen will change to the text indicated in the table above (**Cal. Active**). Read the measurement from your standard and enter it using the numeric keypad. You may now store the new calibration number by pressing the ENTER key or escape by pressing the EXIT key or the RESET button.

AC Source Calibration Low Range 150VAC

The load/meter screen and prompt screens will contain the following text for this calibration point:

Upper Right Screen Load/Meter	Lower Right Screen Prompt	Lower Right Screen Prompt (Cal. Active)
Connect the standard voltmeter 150VAC from output L to N	When the power supply and meter are connected, press TEST to start the calibration.	Enter Standard Current Reading.

Press the TEST button to activate the calibration. After the calibration is activated, the lower right screen will change to the text indicated in the table above (**Cal. Active**). Read the measurement from your standard and enter it using the numeric keypad. You may now store the new calibration number by pressing the ENTER key or escape by pressing the EXIT key or the RESET button.

AC Source Calibration High Range 277VAC

The load/meter screen and prompt screens will contain the following text for this calibration point:

Upper Right Screen Load/Meter	Lower Right Screen Prompt	Lower Right Screen Prompt (Cal. Active)
Connect the standard voltmeter 277VAC from output L to N	When the power supply and meter are connected, press TEST to start the calibration.	Enter Standard Current Reading.

Press the TEST button to activate the calibration. After the calibration is activated, the lower right screen will change to the text indicated in the table above (**Cal. Active**). Read the measurement from your standard and enter it using the numeric keypad. You may now store the new calibration number by pressing the ENTER key or escape by pressing the EXIT key or the RESET button.

11. REPLACEMENT PARTS LIST

Rev: H 11/30/2015 ECO 5802

PART NUMBER	QTY.	REF. DESIGNATOR	DESCRIPTION
Supplied Accessories			
38788	2	-	3U Rack Mount Bracket
38787	2	-	3U Rack Mount Handle
38549	4	-	Screw for Rack Mount Handle
38503	1	-	Fuse 10A 250V Slow-Blow 20mm
04040A-08	1	-	High Voltage Cable
39066	1	-	USB Cable AB-Type 1.8m
33189	1	-	Cable Input Cordset USA
38075	1	-	Interlock Connector
38482	1	-	Adapter Box
0404A-08	1(3)	-	High Voltage Cable (3) for 8206,07,56,57
CBLHC40-10TL	1	-	Case wire for 8206,07,56,57
38489	1	-	Cable Assembly High Current Output
38490	1	-	Cable Assembly High Current Return
Panel Components			
38364	1	-	Fuse Holder 20mm
37478	2	-	High Voltage Connector
37555	1	-	Power Switch 2P 10A/250V
37571	1	-	Earth Connector
37806	1	TEST	Test Switch Green Lighted
37807	1	RESET	Reset Switch Red Lighted
39391	1	TEST	Replacement Bulb
39392	1	RESET	Replacement Bulb
38101	1	-	Feet Kit w/o Rubber Inserts
38102	4	-	Rubber Insert for Feet
39678	1	-	LCD Color Display
39679	4	-	EVA Rubber Blocks for LCD Display
38487	2	-	Socket 80 Amp Red
38488	2	-	Socket 80 Amp Black
PCB Assemblies			
39306	1	AMP7800	Amplifier Board
39307	1	ANG7800	Analog Board
39308	1	CON7800	Main Control Board
39309	1	FB7800	Feedback Board (820X)
39310	1	FIL7800	Filter Board
39311	1	HV7800	High Voltage Control Board (820X)

PART NUMBER	QTY.	REF. DESIGNATOR	DESCRIPTION
39312	1	KEY7800	Key Board
39313	1	PWM7800	PWM Board
39352	1	FB7800	Feedback Board (825X)
39359	1	HV7800	High Voltage Control Board (825X)
39366	1	LCT7800	LCT Board
39373	1	MD7800	Measuring Device Board
39367	1	LAM7800	LCT AC/DC Filter Board
39063	1	USB/RS232	USB/RS232 Interface Board
38305	1	CGP-03	GPIB Interface Board
38543	1	CSU7500	Scanner Control Board
38819	1	38818	Ethernet Card
Internal Components			
37374	1	IC 36	IC 27512 EEPROM
39337	1	T3	Ground Bond Transformer
39336	1	T2	High Voltage Output Transformer
39347	1	IC 10 Main Board	IC 39VF040 Flash Memory
39360	1	-	500VA High Voltage Output Transformer
39385	1	T4	Isolation Transformer
39384	1	7800T1	LCT Power Supply Transformer
38846	1	IC 8 Analog Board	IC W78E516B
38298	1	IC 9 Analog Board	IC ATF16V8B 20PIN PLCC

- For safety tester interconnect cables, refer to **Section 5.1. Instrument Connections.**

12. APPENDIX A

These are additional specifications for the OMNIA II for the AC and DC filtering.

LEAKAGE LIMIT SETTING		
Touch Current High Limit (AC+DC)	Range:	0.0uA ~ 999.9uA 1000uA ~ 10.00mA
	Resolution:	0.1uA / 1uA / 0.01mA
Touch Current Low Limit (AC+DC)	Range:	0.0uA ~ 999.9uA 1000uA ~ 10.00mA
	Resolution:	0.1uA/1uA/0.01mA
Touch Current High Limit (AC Only)	Range:	0.0uA ~ 999.9uA 1000uA ~ 10.00mA
	Resolution:	0.1uA / 1uA / 0.01mA
Touch Current Low Limit (AC Only)	Range:	0.0uA ~ 999.9uA 1000uA ~ 10.00mA
	Resolution:	0.1uA/1uA/0.01mA
Touch Current High Limit (DC Only)	Range:	0.0uA ~ 999.9uA 1000uA ~ 10.00mA
	Resolution:	0.1uA / 1uA / 0.01mA
Touch Current Low Limit (DC Only)	Range:	0.0uA ~ 999.9uA 1000uA ~ 10.00mA
	Resolution:	0.1uA/1uA/0.01mA
Touch Current High Limit (Peak)	Range:	0.0uA - 999.9uA 1000uA ~ 10.00mA
	Resolution:	0.1uA/1uA/0.01mA
Touch Current Low Limit (Peak)	Range:	0.0uA - 999.9uA 1000uA ~ 10.00mA
	Resolution:	0.1uA/1uA/0.01mA

DISPLAY AUTO RANGE			
Touch Current Display (RMS) (AC+DC)	Range 1	0.0uA ~ 32.0uA, frequency DC, 15Hz – 1MHz	
	Resolution	0.1uA	
	Accuracy	DC , 15Hz ≤ f <100KHz: ±(2% of reading + 3counts) 100KHz ≤ f ≤ 1MHZ : ±5% of reading (10.0uA - 999.9uA)	
	Range 2	28.0uA ~ 130.0uA, frequency DC, 15Hz - 1MHz	
	Resolution	0.1uA	
	Accuracy	DC , 15Hz ≤ f <100KHz: ±(2% of reading + 3counts) 100KHz ≤ f ≤ 1MHZ : ±5% of reading (10.0uA - 999.9uA)	
	Range 3	120.0uA ~ 525.0uA, frequency DC, 15Hz - 1MHz	
	Resolution	0.1uA	
	Accuracy	DC , 15Hz ≤ f <100KHz: ±(2% of reading + 3counts) 100KHz ≤ f ≤ 1MHZ : ±5% of reading (10.0uA - 999.9uA)	
	Range 4	400uA ~ 2100uA, frequency DC, 15Hz - 1MHz	
	Resolution	1uA	
	Accuracy	DC , 15Hz ≤ f <100KHz: ±(2% of reading + 3counts) 100KHz ≤ f ≤ 1MHZ : ±5% of reading (10uA - 8500uA)	
	Range 5	1800uA ~ 8400uA, frequency DC, 15Hz - 1MHz	
	Resolution	1uA	
	Accuracy	DC , 15Hz ≤ f <100KHz: ±(2% of reading + 3counts) 100KHz ≤ f ≤ 1MHZ : ±5% of reading (10uA - 8500uA)	
	Range 6	8.00mA ~ 10.00mA, frequency DC, 15Hz – 100kHz	
		Resolution	0.01mA
		Accuracy	DC, 15Hz ≤ f ≤ 100KHz : ±5% of reading (0.01mA -10.00mA)

DISPLAY FIXED RANGE (>6% OF RANGE)			
Touch Current Display (RMS) (AC+DC)	Range 1	0.0uA ~ 32.0uA, frequency DC - 1MHz	
	Resolution	0.1uA	
	Base Accuracy	DC, 15Hz ≤ f ≤ 100KHz: ±(2% of reading + 3counts) 100KHz ≤ f ≤ 1MHz : ±5% of reading (10.0uA - 999.9uA)	
	Range 2	7.8uA ~ 130.0uA, frequency DC - 1MHz	
	Resolution	0.1uA	
	Base Accuracy	DC, 15Hz ≤ f ≤ 100KHz: ±(2% of reading + 3counts) 100KHz ≤ f ≤ 1MHz : ±5% of reading (10.0uA - 999.9uA)	
	Range 3	31.5uA ~ 525.0uA, frequency DC - 1MHz	
	Resolution	0.1uA	
	Base Accuracy	DC, 15Hz ≤ f ≤ 100KHz: ±(2% of reading + 3counts) 100KHz ≤ f ≤ 1MHz : ±5% of reading (10.0uA - 999.9uA)	
	Range 4	126.0uA ~ 999.9uA, 1000uA ~ 2100uA, frequency DC - 1MHz	
	Resolution	1uA	
	Base Accuracy	DC, 15Hz ≤ f ≤ 100KHz: ±(2% of reading + 3counts) 100KHz ≤ f ≤ 1MHz : ±5% of reading (10.0uA - 999.9uA)	
	Range 5	504uA ~ 999.9uA, 1000uA ~ 8400uA, frequency DC - 1MHz	
	Resolution	1uA	
	Base Accuracy	DC, 15Hz ≤ f ≤ 100KHz: ±(2% of reading + 3counts) 100KHz ≤ f ≤ 1MHz : ±5% of reading (10.0uA - 999.9uA)	
	Range 6	600uA ~ 8399uA, 8.40mA ~ 10.00mA, frequency DC – 100KHz	
		Resolution	1uA, 0.01mA
		Base Accuracy	DC, 15Hz ≤ f ≤ 100KHz : ±5% of reading (0.01mA -10.00mA)

DISPLAY FIXED RANGE (<6% OF RANGE)		
Touch Current Display (RMS) (AC+DC)	Range 1	N/A
	Resolution	N/A
	Additional Error	N/A
	Range 2	0.0uA ~ 7.8uA, frequency DC - 1MHz
	Resolution	0.1uA
	Additional Error	DC, $15\text{Hz} \leq f \leq 100\text{KHz}$: add $\pm(2\%$ of reading + 0.2% of range) to base accuracy $100\text{KHz} \leq f \leq 1\text{MHz}$: add $\pm(2\%$ of reading + 0.5% of range) to base accuracy
	Range 3	0.0uA ~ 31.5uA, frequency DC - 1MHz
	Resolution	0.1uA
	Additional Error	DC, $15\text{Hz} \leq f \leq 100\text{KHz}$: add $\pm(2\%$ of reading + 0.2% of range) to base accuracy $100\text{KHz} \leq f \leq 1\text{MHz}$: add $\pm(2\%$ of reading + 0.5% of range) to base accuracy
	Range 4	0.0uA ~ 126.0uA, frequency DC - 1MHz
	Resolution	1uA
	Additional Error	DC, $15\text{Hz} \leq f \leq 100\text{KHz}$: add $\pm(2\%$ of reading + 0.2% of range) to base accuracy $100\text{KHz} \leq f \leq 1\text{MHz}$: add $\pm(2\%$ of reading + 0.5% of range) to base accuracy
	Range 5	0.0uA ~ 504uA, frequency DC - 1MHz
	Resolution	1uA
	Additional Error	DC, $15\text{Hz} \leq f \leq 100\text{KHz}$: add $\pm(2\%$ of reading + 0.2% of range) to base accuracy $100\text{KHz} \leq f \leq 1\text{MHz}$: add $\pm(2\%$ of reading + 0.5% of range) to base accuracy
	Range 6	0.0uA ~ 600uA, frequency DC – 100KHz
	Resolution	1uA

	Additional Error	DC, $15\text{Hz} \leq f \leq 100\text{KHz}$: add $\pm(2\%$ of reading + 0.2% of range) to base accuracy
DISPLAY AUTO RANGE		
Touch Current Display (RMS) (AC Only)	Range 1	0.0uA ~ 32.0uA, frequency 15Hz – 1MHz
	Resolution	0.1uA
	Accuracy	15Hz $\leq f < 30\text{Hz}$: $\pm(3\%$ of reading + 5counts) 30Hz $\leq f \leq 100\text{KHz}$: $\pm(2\%$ of reading + 3counts) 100KHz $\leq f \leq 1\text{MHz}$: $\pm 5\%$ of reading (10.0uA - 999.9uA)
	Range 2	28.0uA ~ 130.0uA, frequency 15Hz - 1MHz
	Resolution	0.1uA
	Accuracy	15Hz $\leq f < 30\text{Hz}$: $\pm(3\%$ of reading + 5counts) 30Hz $\leq f \leq 100\text{KHz}$: $\pm(2\%$ of reading + 3counts) 100KHz $\leq f \leq 1\text{MHz}$: $\pm 5\%$ of reading (10.0uA - 999.9uA)
	Range 3	120.0uA ~ 525.0uA, frequency 15Hz - 1MHz
	Resolution	0.1uA
	Accuracy	15Hz $\leq f < 30\text{Hz}$: $\pm(3\%$ of reading + 5counts) 30Hz $\leq f \leq 100\text{KHz}$: $\pm(2\%$ of reading + 3counts) 100KHz $\leq f \leq 1\text{MHz}$: $\pm 5\%$ of reading (10.0uA - 999.9uA)
	Range 4	400uA ~ 2100uA, frequency 15Hz - 1MHz
	Resolution	0.1uA, 1 uA
		Accuracy
Range 5		1800uA ~ 8400uA, frequency 15Hz - 1MHz
Resolution		1uA
Accuracy		15Hz $\leq f < 30\text{Hz}$: $\pm(3\%$ of reading + 5counts) 30Hz $\leq f \leq 100\text{KHz}$: $\pm(2\%$ of reading + 3counts) 100KHz $\leq f \leq 1\text{MHz}$: $\pm 5\%$ of reading (10.0uA - 999.9uA)
Range 6		8.00mA ~ 10.00mA, frequency 15Hz – 100kHz
Resolution		1uA, 0.01mA

	Accuracy	15Hz < f < 100KHz : $\pm 5\%$ of reading (0.01mA -20.00mA)
DISPLAY FIXED RANGE (>6% OF RANGE)		
Touch Current Display (RMS) (AC Only)	Range 1	0.0uA ~ 32.0uA, frequency 15Hz - 1MHz
	Resolution	0.1uA
	Base Accuracy	15Hz \leq f < 30Hz: $\pm(3\%$ of reading + 5counts) 30Hz \leq f \leq 100KHz : $\pm(2\%$ of reading + 3counts) 100KHz \leq f \leq 1MHZ : $\pm 5\%$ of reading (10.0uA - 999.9uA)
	Range 2	7.8uA ~ 130.0uA, frequency 15Hz - 1MHz
	Resolution	0.1uA
	Base Accuracy	15Hz \leq f < 30Hz: $\pm(3\%$ of reading + 5counts) 30Hz \leq f \leq 100KHz : $\pm(2\%$ of reading + 3counts) 100KHz \leq f \leq 1MHZ : $\pm 5\%$ of reading (10.0uA - 999.9uA)
	Range 3	31.5uA ~ 525.0uA, frequency 15Hz - 1MHz
	Resolution	0.1uA
	Base Accuracy	15Hz \leq f < 30Hz: $\pm(3\%$ of reading + 5counts) 30Hz \leq f \leq 100KHz : $\pm(2\%$ of reading + 3counts) 100KHz \leq f \leq 1MHZ : $\pm 5\%$ of reading (10.0uA - 999.9uA)
	Range 4	126.0uA ~ 999.9uA, 1000uA ~ 2100uA, frequency 15Hz - 1MHz
	Resolution	1uA
	Base Accuracy	15Hz \leq f < 30Hz: $\pm(3\%$ of reading + 5counts) 30Hz \leq f \leq 100KHz : $\pm(2\%$ of reading + 3counts) 100KHz \leq f \leq 1MHZ : $\pm 5\%$ of reading (10.0uA - 999.9uA)
	Range 5	504uA ~ 999.9uA, 1000uA ~ 8400uA, frequency 15Hz - 1MHz
	Resolution	1uA
Base Accuracy	15Hz \leq f < 30Hz: $\pm(3\%$ of reading + 5counts) 30Hz \leq f \leq 100KHz : $\pm(2\%$ of reading + 3counts) 100KHz \leq f \leq 1MHZ : $\pm 5\%$ of reading (10.0uA - 999.9uA)	

	Range 6	600uA ~ 8399uA, 8.40mA ~ 20.00mA, frequency 15Hz - 1MHz
	Resolution	1uA, 0.01mA
	Base Accuracy	$15\text{Hz} \leq f \leq 100\text{KHz}$: $\pm 5\%$ of reading (0.01mA -20.00mA)
DISPLAY FIXED RANGE (<6% OF RANGE)		
Touch Current Display (RMS) (AC Only)	Range 1	N/A
	Resolution	N/A
	Additional Error	N/A
	Range 2	0.0uA ~ 7.8uA, frequency 15Hz - 1MHz
	Resolution	0.1uA
	Additional Error	$15\text{Hz} \leq f < 30\text{Hz}$: add $\pm(2\%$ of reading + 0.2% of range) to base accuracy $30\text{Hz} \leq f \leq 100\text{KHz}$: add $\pm(2\%$ of reading + 0.2% of range) to base accuracy $100\text{KHz} \leq f \leq 1\text{MHz}$: add $\pm(2\%$ of reading + 0.5% of range) to base accuracy
	Range 3	0.0uA ~ 31.5uA, frequency 15Hz - 1MHz
	Resolution	0.1uA
	Additional Error	$15\text{Hz} \leq f < 30\text{Hz}$: add $\pm(2\%$ of reading + 0.2% of range) to base accuracy $30\text{Hz} \leq f \leq 100\text{KHz}$: add $\pm(2\%$ of reading + 0.2% of range) to base accuracy $100\text{KHz} \leq f \leq 1\text{MHz}$: add $\pm(2\%$ of reading + 0.5% of range) to base accuracy
	Range 4	0.0uA ~ 126.0uA, frequency 15Hz - 1MHz
	Resolution	1uA
	Additional Error	$15\text{Hz} \leq f < 30\text{Hz}$: add $\pm(2\%$ of reading + 0.2% of range) to base accuracy $30\text{Hz} \leq f \leq 100\text{KHz}$: add $\pm(2\%$ of reading + 0.2% of range) to base accuracy $100\text{KHz} \leq f \leq 1\text{MHz}$: add $\pm(2\%$ of reading + 0.5% of range) to base accuracy
	Range 5	0.0uA ~ 504uA, frequency 15Hz - 1MHz

	Resolution	1uA
	Additional Error	15Hz ≤ f < 30Hz: add ±(2% of reading + 0.2% of range) to base accuracy 30Hz ≤ f ≤ 100KHz : add ±(2% of reading + 0.2% of range) to base accuracy 100KHz ≤ f ≤ 1MHZ : add ±(2% of reading + 0.5% of range) to base accuracy
	Range 6	0.0uA ~ 600uA, frequency DC – 100KHz
	Resolution	1uA
	Additional Error	15Hz ≤ f ≤ 100KHz : add ±(2% of reading + 0.2% of range) to base accuracy
DISPLAY AUTO RANGE		
Touch Current Display (DC Only)	Range 1	0.0uA ~ 32.0uA, DC
	Resolution	0.1uA
	Accuracy	DC : ±(2% of reading + 3counts)
	Range 2	28.0uA ~ 130.0uA, DC
	Resolution	0.1uA
	Accuracy	DC : ±(2% of reading + 3counts)
	Range 3	120.0uA ~ 525.0uA, DC
	Resolution	0.1uA
	Accuracy	DC : ±(2% of reading + 3counts)
	Range 4	400uA ~ 2100uA, DC
	Resolution	0.1uA, 1uA
	Accuracy	DC : ±(2% of reading + 3counts)
	Range 5	1800uA ~ 8400uA, DC
	Resolution	1uA
	Accuracy	DC : ±(2% of reading + 3counts)
	Range 6	8.00mA ~ 10.00mA, DC
Resolution	1uA, 0.01mA	
Accuracy	DC : ±5% of reading (0.01mA - 10.00mA)	

DISPLAY FIXED RANGE (>6% OF RANGE)			
Touch Current Display	(DC Only)	Range 1	0.0uA ~ 32.0uA, DC
		Resolution	0.1uA
		Base Accuracy	DC : $\pm(2\%$ of reading + 3counts) (>10uA)
		Range 2	7.8uA ~ 130.0uA, DC
		Resolution	0.1uA
		Base Accuracy	DC : $\pm(2\%$ of reading + 3counts) (>10uA)
		Range 3	31.5uA ~ 525.0uA, DC
		Resolution	0.1uA
		Base Accuracy	DC : $\pm(2\%$ of reading + 3counts) (>10uA)
		Range 4	126.0uA ~ 999.9uA, 1000uA ~ 2100uA, DC
		Resolution	1uA
		Base Accuracy	DC : $\pm(2\%$ of reading + 3counts) (>10uA)
		Range 5	504uA ~ 999.9uA, 1000uA ~ 8400uA, DC
		Resolution	1uA
		Base Accuracy	DC : $\pm(2\%$ of reading + 3counts) (>10uA)
		Range 6	600uA ~ 8399uA, 8.40mA ~ 10.00mA, DC
		Resolution	1uA, 0.01mA
		Base Accuracy	DC : $\pm 5\%$ of reading (0.01mA - 10.00mA)
DISPLAY FIXED RANGE (<6% OF RANGE)			
Touch Current Display	(DC Only)	Range 1	N/A
		Resolution	N/A
		Additional Error	N/A
		Range 2	0.0uA ~ 7.8uA, DC

	Resolution	0.1uA
	Additional Error	DC: add $\pm(2\%$ of reading + 0.2% of range) to base accuracy
	Range 3	0.0uA ~ 31.5uA, DC
	Resolution	0.1uA
	Additional Error	DC: add $\pm(2\%$ of reading + 0.2% of range) to base accuracy
	Range 4	0.0uA ~ 126.0uA, DC
	Resolution	1uA
	Additional Error	DC: add $\pm(2\%$ of reading + 0.2% of range) to base accuracy
	Range 5	0.0uA ~ 504uA, DC
	Resolution	1uA
	Additional Error	DC: add $\pm(2\%$ of reading + 0.2% of range) to base accuracy
	Range 6	0.0uA ~ 999.9uA, 1000uA ~ 1200uA, DC
	Resolution	1uA
	Additional Error	DC: add $\pm(2\%$ of reading + 0.2% of range) to base accuracy
DISPLAY AUTO RANGE		
Touch Current Display (Peak) (AC+DC)	Range 1	0.0uA ~ 32.0uA, frequency DC, 15Hz – 1MHz
	Resolution	0.1uA
	Accuracy	DC: $\pm(2\%$ of reading + 2uA) , 15Hz \leq f < 1MHz: $\pm(10\%$ of reading + 2uA)
	Range 2	28.0uA ~ 130.0uA, frequency DC, 15Hz - 1MHz
	Resolution	0.1uA
	Accuracy	DC: $\pm(2\%$ of reading + 2uA) , 15Hz \leq f < 1MHz: $\pm(10\%$ of reading + 2uA)
	Range 3	120.0uA ~ 525.0uA, frequency DC, 15Hz - 1MHz
	Resolution	0.1uA
	Accuracy	DC: $\pm(2\%$ of reading + 2uA) , 15Hz \leq f < 1MHz: $\pm(10\%$ of reading + 2uA)
	Range 4	400uA ~ 999.9uA, 1000uA-2100uA,

		frequency DC, 15Hz - 1MHz
	Resolution	0.1uA, 1uA
	Accuracy	DC: $\pm(2\% \text{ of reading} + 2\mu\text{A})$, 15Hz $\leq f < 1\text{MHz}$: $\pm(10\% \text{ of reading} + 2\mu\text{A})$
	Range 5	1800uA ~ 8400uA, frequency DC, 15Hz - 1MHz
	Resolution	1uA
	Accuracy	DC: $\pm(2\% \text{ of reading} + 2\mu\text{A})$, 15Hz $\leq f < 1\text{MHz}$: $\pm(10\% \text{ of reading} + 2\mu\text{A})$
	Range 6	8000uA ~ 8399uA, 8.40mA ~ 10.00mA, frequency DC, 15Hz – 100KHz
	Resolution	1uA, 0.01mA
	Accuracy	DC: $\pm(2\% \text{ of reading} + 3\text{counts})$, 15Hz $\leq f < 100\text{KHz}$: $\pm(10\% \text{ of reading} + 2\text{counts})$
DISPLAY FIXED RANGE (>6% OF RANGE)		
Touch Current Display (Peak) (AC+DC)	Range 1	0.0uA ~ 32.0uA, frequency 15Hz - 1MHz
	Resolution	0.1uA
	Base Accuracy	DC: $\pm(2\% \text{ of reading} + 2\mu\text{A})$ 15Hz $\leq f \leq 100\text{KHz}$: $\pm(10\% \text{ of reading} + 2\mu\text{A})$ 100KHz $\leq f \leq 1\text{MHz}$: $\pm(10\% \text{ of reading} + 2\mu\text{A})$
	Range 2	7.8uA ~ 130.0uA, frequency 15Hz - 1MHz
	Resolution	0.1uA
	Base Accuracy	DC: $\pm(2\% \text{ of reading} + 2\mu\text{A})$ 15Hz $\leq f \leq 100\text{KHz}$: $\pm(10\% \text{ of reading} + 2\mu\text{A})$ 100KHz $\leq f \leq 1\text{MHz}$: $\pm(10\% \text{ of reading} + 2\mu\text{A})$
	Range 3	31.5uA ~ 525.0uA, frequency 15Hz - 1MHz
	Resolution	0.1uA
	Base Accuracy	DC: $\pm(2\% \text{ of reading} + 2\mu\text{A})$ 15Hz $\leq f \leq 100\text{KHz}$: $\pm(10\% \text{ of reading} + 2\mu\text{A})$ 100KHz $\leq f \leq 1\text{MHz}$: $\pm(10\% \text{ of reading} + 2\mu\text{A})$
	Range 4	126.0uA ~ 999.9uA, 1000uA ~ 2100uA, frequency 15Hz - 1MHz
	Resolution	1uA

	Base Accuracy	DC: $\pm(2\%$ of reading + 2uA) 15Hz $\leq f \leq$ 100KHz : $\pm(10\%$ of reading + 2uA) 100KHz $\leq f \leq$ 1MHZ : $\pm(10\%$ of reading + 2uA)
	Range 5	504uA ~ 999.9uA, 1000uA ~ 8400uA, frequency 15Hz - 1MHz
	Resolution	1uA
	Base Accuracy	DC: $\pm(2\%$ of reading + 2uA) 15Hz $\leq f \leq$ 100KHz : $\pm(10\%$ of reading + 2uA) 100KHz $\leq f \leq$ 1MHZ : $\pm(10\%$ of reading + 2uA)
	Range 6	1200uA ~ 8399uA, 8.40mA ~ 10.00mA, frequency 15Hz - 1MHz
	Resolution	1uA, 0.01mA
	Base Accuracy	DC: $\pm(2\%$ of reading + 3counts) ,15Hz $\leq f <$ 100KHz: $\pm(10\%$ of reading + 2counts)
DISPLAY FIXED RANGE (<6% OF RANGE)		
Touch Current Display (Peak) (AC+DC)	Range 1	N/A
	Resolution	N/A
	Additional Error	N/A
	Range 2	0.0uA ~ 7.8uA, frequency 15Hz - 1MHz
	Resolution	0.1uA
	Additional Error	DC: add $\pm(2\%$ of reading + 0.2% of range) to base accuracy 15Hz $\leq f \leq$ 100KHz : add $\pm(2\%$ of reading + 0.2% of range) to base accuracy 100KHz $\leq f \leq$ 1MHZ : add $\pm(2\%$ of reading + 0.5% of range) to base accuracy
	Range 3	0.0uA ~ 31.5uA, frequency 15Hz - 1MHz
	Resolution	0.1uA
	Additional Error	DC: add $\pm(2\%$ of reading + 0.2% of range) to base accuracy 15Hz $\leq f \leq$ 100KHz : add $\pm(2\%$ of reading + 0.2% of range) to base accuracy 100KHz $\leq f \leq$ 1MHZ : add $\pm(2\%$ of reading + 0.5% of range) to base accuracy

	Range 4	0.0uA ~ 126.0uA, frequency 15Hz - 1MHz
	Resolution	1uA
	Additional Error	DC: add $\pm(2\%$ of reading + 0.2% of range) to base accuracy $15\text{Hz} \leq f \leq 100\text{KHz}$: add $\pm(2\%$ of reading + 0.2% of range) to base accuracy $100\text{KHz} \leq f \leq 1\text{MHz}$: add $\pm(2\%$ of reading + 0.5% of range) to base accuracy
	Range 5	0.0uA ~ 504uA, frequency 15Hz - 1MHz
	Resolution	1uA
	Additional Error	DC: add $\pm(2\%$ of reading + 0.2% of range) to base accuracy $15\text{Hz} \leq f \leq 100\text{KHz}$: add $\pm(2\%$ of reading + 0.2% of range) to base accuracy $100\text{KHz} \leq f \leq 1\text{MHz}$: add $\pm(2\%$ of reading + 0.5% of range) to base accuracy
	Range 6	0.0uA ~ 600uA, frequency DC – 100KHz
	Resolution	1uA
	Additional Error	DC: add $\pm(2\%$ of reading + 0.2% of range) to base accuracy $15\text{Hz} \leq f \leq 100\text{KHz}$: add $\pm(2\%$ of reading + 0.2% of range) to base accuracy
DISPLAY AUTO RANGE		
Touch Current Display (Peak) (AC Only)	Range 1	0.0uA ~ 32.0uA, frequency DC, 15Hz – 1MHz
	Resolution	0.1uA
	Accuracy	$15\text{Hz} \leq f < 1\text{MHz}$: $\pm(10\%$ of reading + 2uA)
	Range 2	28.0uA ~ 130.0uA, frequency DC, 15Hz - 1MHz
	Resolution	0.1uA
	Accuracy	$15\text{Hz} \leq f < 1\text{MHz}$: $\pm(10\%$ of reading + 2uA)
	Range 3	120.0uA ~ 525.0uA, frequency DC, 15Hz - 1MHz
	Resolution	0.1uA
	Accuracy	$15\text{Hz} \leq f < 1\text{MHz}$: $\pm(10\%$ of reading + 2uA)

	Range 4	400uA ~ 999.9uA, 1000uA-2100uA, frequency DC, 15Hz - 1MHz
	Resolution	0.1uA, 1uA
	Accuracy	15Hz ≤ f < 1MHz: ±(10% of reading + 2uA)
	Range 5	1800uA ~ 8400uA, frequency DC, 15Hz - 1MHz
	Resolution	1uA
	Accuracy	15Hz ≤ f < 1MHz: ±(10% of reading + 2uA)
	Range 6	8000uA ~ 8399uA, 8.40mA ~ 10.00mA, frequency DC, 15Hz – 100KHz
	Resolution	1uA, 0.01mA
	Accuracy	15Hz ≤ f < 100KHz: ±(10% of reading + 2counts)
DISPLAY FIXED RANGE (>6% OF RANGE)		
Touch Current Display (Peak) (AC Only)	Range 1	0.0uA ~ 32.0uA, frequency 15Hz - 1MHz
	Resolution	0.1uA
	Base Accuracy	15Hz ≤ f ≤ 100KHz : ±(10% of reading + 2uA) 100KHz ≤ f ≤ 1MHZ : ±(10% of reading + 2uA)
	Range 2	7.8uA ~ 130.0uA, frequency 15Hz - 1MHz
	Resolution	0.1uA
	Base Accuracy	15Hz ≤ f ≤ 100KHz : ±(10% of reading + 2uA) 100KHz ≤ f ≤ 1MHZ : ±(10% of reading + 2uA)
	Range 3	31.5uA ~ 525.0uA, frequency 15Hz - 1MHz
	Resolution	0.1uA
	Base Accuracy	15Hz ≤ f ≤ 100KHz : ±(10% of reading + 2uA) 100KHz ≤ f ≤ 1MHZ : ±(10% of reading + 2uA)
	Range 4	126.0uA ~ 999.9uA, 1000uA ~ 2100uA, frequency 15Hz - 1MHz
	Resolution	1uA
	Base Accuracy	15Hz ≤ f ≤ 100KHz : ±(10% of reading + 2uA) 100KHz ≤ f ≤ 1MHZ : ±(10% of reading + 2uA)

	Range 5	504uA ~ 999.9uA, 1000uA ~ 8400uA, frequency 15Hz - 1MHz
	Resolution	1uA
	Base Accuracy	15Hz ≤ f ≤ 100KHz : ±(10% of reading + 2uA) 100KHz ≤ f ≤ 1MHZ : ±(10% of reading + 2uA)
	Range 6	1200uA ~ 8399uA, 8.40mA ~ 10.00mA, frequency 15Hz - 1MHz
	Resolution	1uA, 0.01mA
	Base Accuracy	15Hz ≤ f < 100KHz: ±(10% of reading + 2counts)
DISPLAY FIXED RANGE (<6% OF RANGE)		
Touch Current Display (Peak) (AC Only)	Range 1	N/A
	Resolution	N/A
	Additional Error	N/A
	Range 2	0.0uA ~ 7.8uA, frequency 15Hz - 1MHz
	Resolution	0.1uA
	Additional Error	15Hz ≤ f ≤ 100KHz : add ±(2% of reading + 0.2% of range) to base accuracy 100KHz ≤ f ≤ 1MHZ : add ±(2% of reading + 0.5% of range) to base accuracy
	Range 3	0.0uA ~ 31.5uA, frequency 15Hz - 1MHz
	Resolution	0.1uA
	Additional Error	15Hz ≤ f ≤ 100KHz : add ±(2% of reading + 0.2% of range) to base accuracy 100KHz ≤ f ≤ 1MHZ : add ±(2% of reading + 0.5% of range) to base accuracy
	Range 4	0.0uA ~ 126.0uA, frequency 15Hz - 1MHz
	Resolution	1uA
	Additional Error	15Hz ≤ f ≤ 100KHz : add ±(2% of reading + 0.2% of range) to base accuracy 100KHz ≤ f ≤ 1MHZ : add ±(2% of reading + 0.5% of range) to base accuracy
	Additional Error	15Hz ≤ f ≤ 100KHz : add ±(2% of reading + 0.2% of range) to base accuracy 100KHz ≤ f ≤ 1MHZ : add ±(2% of reading + 0.5% of range) to base accuracy

	Range 5	0.0uA ~ 504uA, frequency 15Hz - 1MHz
	Resolution	1uA
	Additional Error	15Hz ≤ f ≤ 100KHz : add ±(2% of reading + 0.2% of range) to base accuracy 100KHz ≤ f ≤ 1MHz : add ±(2% of reading + 0.5% of range) to base accuracy
	Range 6	0.0uA ~ 600uA, frequency DC – 100KHz
	Resolution	1uA
	Additional Error	15Hz ≤ f ≤ 100KHz : add ±(2% of reading + 0.2% of range) to base accuracy
DISPLAY AUTO RANGE		
Touch Voltage Display (RMS) (AC+DC)	Range 1	0.0mV ~ 32.0mV, frequency DC, 15Hz – 1MHz
	Resolution	0.1mV
	Accuracy	DC , 15Hz ≤ f <100KHz: ±(2% of reading + 3counts) 100KHz ≤ f ≤ 1MHz : ±5% of reading (10.0mV - 999.9mV)
	Range 2	28.0mV ~ 130.0mV, frequency DC, 15Hz - 1MHz
	Resolution	0.1mV
	Accuracy	DC , 15Hz ≤ f <100KHz: ±(2% of reading + 3counts) 100KHz ≤ f ≤ 1MHz : ±5% of reading (10.0mV - 999.9mV)
	Range 3	120.0mV ~ 525.0mV, frequency DC, 15Hz - 1MHz
	Resolution	0.1mV
	Accuracy	DC , 15Hz ≤ f <100KHz: ±(2% of reading + 3counts) 100KHz ≤ f ≤ 1MHz : ±5% of reading (10.0mV - 999.9mV)
	Range 4	400mV ~ 999.9mV, 1000mV ~ 2100mV, frequency DC, 15Hz - 1MHz
	Resolution	0.1mV, 1mV
	Accuracy	DC , 15Hz ≤ f <100KHz: ±(2% of reading + 3counts) 100KHz ≤ f ≤ 1MHz : ±5% of reading (10mV - 8500mV)
	Range 5	1800mV ~ 8400mV, frequency DC, 15Hz - 1MHz
	Resolution	1mV

	Accuracy	DC , $15\text{Hz} \leq f < 100\text{KHz}$: $\pm(2\%$ of reading + 3counts) $100\text{KHz} \leq f \leq 1\text{MHZ}$: $\pm 5\%$ of reading (10mV - 8500mV)
	Range 6	8000mV ~ 8399mV, 8.40V ~ 10.00V, frequency DC, 15Hz – 100kHz
	Resolution	1mV, 0.01V
	Accuracy	DC, $15\text{Hz} < f < 100\text{KHz}$: $\pm 5\%$ of reading (0.01V -10.00V)
DISPLAY FIXED RANGE (>6% OF RANGE)		
Touch Voltage Display (RMS) (AC+DC)	Range 1	0.0mV ~ 32.0mV, frequency DC, 15Hz – 1MHz
	Resolution	0.1mV
	Basic Accuracy	DC , $15\text{Hz} \leq f < 100\text{KHz}$: $\pm(2\%$ of reading + 3counts) $100\text{KHz} \leq f \leq 1\text{MHZ}$: $\pm 5\%$ of reading (10.0mV - 999.9mV)
	Range 2	7.8mV ~ 130.0mV, frequency DC, 15Hz - 1MHz
	Resolution	0.1mV
	Basic Accuracy	DC , $15\text{Hz} \leq f < 100\text{KHz}$: $\pm(2\%$ of reading + 3counts) $100\text{KHz} \leq f \leq 1\text{MHZ}$: $\pm 5\%$ of reading (10.0mV - 999.9mV)
	Range 3	31.5mV ~ 525.0mV, frequency DC, 15Hz - 1MHz
	Resolution	0.1mV
	Basic Accuracy	DC , $15\text{Hz} \leq f < 100\text{KHz}$: $\pm(2\%$ of reading + 3counts) $100\text{KHz} \leq f \leq 1\text{MHZ}$: $\pm 5\%$ of reading (10.0mV - 999.9mV)
	Range 4	126.0mV ~ 999.9mV, 1000mV ~ 2100mV, frequency DC, 15Hz - 1MHz
	Resolution	1mV
	Basic Accuracy	DC , $15\text{Hz} \leq f < 100\text{KHz}$: $\pm(2\%$ of reading + 3counts) $100\text{KHz} \leq f \leq 1\text{MHZ}$: $\pm 5\%$ of reading (10mV - 8500mV)
	Range 5	504.0mV ~ 999.9mV, 1000mV ~ 8400mV, frequency DC, 15Hz - 1MHz
	Resolution	1mV
	Basic Accuracy	DC , $15\text{Hz} \leq f < 100\text{KHz}$: $\pm(2\%$ of reading + 3counts) $100\text{KHz} \leq f \leq 1\text{MHZ}$: $\pm 5\%$ of reading (10mV - 8500mV)
	Range 6	600mV ~ 8399mV, 8.40V ~ 10.00V, frequency DC, 15Hz – 100kHz
	Resolution	1mV, 0.01V

	Basic Accuracy	DC, 15Hz < f < 100KHz : $\pm 5\%$ of reading (0.01V -20.00V)
DISPLAY FIXED RANGE (<6% OF RANGE)		
Touch Voltage Display (RMS) (AC+DC)	Range 1	N/A
	Resolution	N/A
	Additional Error	N/A
	Range 2	0.0mV ~ 7.8mV, frequency 15Hz - 1MHz
	Resolution	0.1mV
	Additional Error	15Hz \leq f \leq 100KHz : add $\pm(2\%$ of reading + 0.2% of range) to base accuracy 100KHz \leq f \leq 1MHz : add $\pm(2\%$ of reading + 0.5% of range) to base accuracy
	Range 3	0.0mV ~ 31.5mV, frequency 15Hz - 1MHz
	Resolution	0.1mV
	Additional Error	15Hz \leq f \leq 100KHz : add $\pm(2\%$ of reading + 0.2% of range) to base accuracy 100KHz \leq f \leq 1MHz : add $\pm(2\%$ of reading + 0.5% of range) to base accuracy
	Range 4	0.0mV ~ 126.0mV, frequency 15Hz - 1MHz
	Resolution	1mV
	Additional Error	15Hz \leq f \leq 100KHz : add $\pm(2\%$ of reading + 0.2% of range) to base accuracy 100KHz \leq f \leq 1MHz : add $\pm(2\%$ of reading + 0.5% of range) to base accuracy
	Range 5	0.0mV ~ 504mV, frequency 15Hz - 1MHz
	Resolution	1mV
	Additional Error	15Hz \leq f \leq 100KHz : add $\pm(2\%$ of reading + 0.2% of range) to base accuracy 100KHz \leq f \leq 1MHz : add $\pm(2\%$ of reading + 0.5% of range) to base accuracy
	Range 6	0.0mV ~ 600mV, frequency DC – 100KHz

	Resolution	1mV
	Additional Error	DC, 15Hz ≤ f ≤ 100KHz : add ±(2% of reading + 0.2% of range) to base accuracy
DISPLAY AUTO RANGE		
Touch Voltage Display (RMS) (AC Only)	Range 1	0.0mV ~ 32.0mV, frequency DC, 15Hz – 1MHz
	Resolution	0.1mV
	Accuracy	15Hz ≤ f < 30Hz: ±(3% of reading + 5counts) 30Hz ≤ f < 100KHz: ±(2% of reading + 3counts) 100KHz ≤ f ≤ 1MHz : ±5% of reading (10.0mV - 999.9mV)
	Range 2	28.0mV ~ 130.0mV, frequency DC, 15Hz - 1MHz
	Resolution	0.1mV
	Accuracy	15Hz ≤ f < 30Hz: ±(3% of reading + 5counts) 30Hz ≤ f < 100KHz: ±(2% of reading + 3counts) 100KHz ≤ f ≤ 1MHz : ±5% of reading (10.0mV - 999.9mV)
	Range 3	120.0mV ~ 525.0mV, frequency DC, 15Hz - 1MHz
	Resolution	0.1mV
	Accuracy	15Hz ≤ f < 30Hz: ±(3% of reading + 5counts) 30Hz ≤ f < 100KHz: ±(2% of reading + 3counts) 100KHz ≤ f ≤ 1MHz : ±5% of reading (10.0mV - 999.9mV)
	Range 4	400mV ~ 999.9mV, 1000mV ~ 2100mV, frequency DC, 15Hz - 1MHz
	Resolution	0.1mV, 1mV
	Accuracy	15Hz ≤ f < 30Hz: ±(3% of reading + 5counts) 30Hz ≤ f < 100KHz: ±(2% of reading + 3counts) 100KHz ≤ f ≤ 1MHz : ±5% of reading (10.0mV - 999.9mV)
	Range 5	1800mV ~ 8400mV, frequency DC, 15Hz - 1MHz
	Resolution	1mV
	Accuracy	15Hz ≤ f < 30Hz: ±(3% of reading + 5counts) 30Hz ≤ f < 100KHz: ±(2% of reading + 3counts) 100KHz ≤ f ≤ 1MHz : ±5% of reading (10.0mV - 999.9mV)
	Range 6	8000mV ~ 8399mV, 8.40V ~ 10.00V, frequency DC, 15Hz – 100kHz

	Resolution	1mV, 0.01V
	Accuracy	15Hz < f < 100KHz : $\pm 5\%$ of reading (0.01V - 10.00V)
DISPLAY FIXED RANGE (>6% OF RANGE)		
Touch Voltage Display (RMS) (AC Only)	Range 1	0.0mV ~ 32.0mV, frequency DC, 15Hz – 1MHz
	Resolution	0.1mV
	Basic Accuracy	15Hz \leq f < 30Hz: $\pm(3\%$ of reading + 5counts) 30Hz \leq f < 100KHz: $\pm(2\%$ of reading + 3counts) 100KHz \leq f \leq 1MHz : $\pm 5\%$ of reading (10.0mV - 999.9mV)
	Range 2	7.8mV ~ 130.0mV, frequency DC, 15Hz - 1MHz
	Resolution	0.1mV
	Basic Accuracy	15Hz \leq f < 30Hz: $\pm(3\%$ of reading + 5counts) 30Hz \leq f < 100KHz: $\pm(2\%$ of reading + 3counts) 100KHz \leq f \leq 1MHz : $\pm 5\%$ of reading (10.0mV - 999.9mV)
	Range 3	31.5mV ~ 525.0mV, frequency DC, 15Hz - 1MHz
	Resolution	0.1mV
	Basic Accuracy	15Hz \leq f < 30Hz: $\pm(3\%$ of reading + 5counts) 30Hz \leq f < 100KHz: $\pm(2\%$ of reading + 3counts) 100KHz \leq f \leq 1MHz : $\pm 5\%$ of reading (10.0mV - 999.9mV)
	Range 4	126.0mV ~ 999.9mV, 1000mV ~ 2100mV, frequency DC, 15Hz - 1MHz
	Resolution	1mV
	Basic Accuracy	15Hz \leq f < 30Hz: $\pm(3\%$ of reading + 5counts) 30Hz \leq f < 100KHz: $\pm(2\%$ of reading + 3counts) 100KHz \leq f \leq 1MHz : $\pm 5\%$ of reading (10.0mV - 999.9mV)
	Range 5	504.0mV ~ 999.9mV, 1000mV ~ 8400mV, frequency DC, 15Hz - 1MHz
	Resolution	1mV
	Basic Accuracy	15Hz \leq f < 30Hz: $\pm(3\%$ of reading + 5counts) 30Hz \leq f < 100KHz: $\pm(2\%$ of reading + 3counts) 100KHz \leq f \leq 1MHz : $\pm 5\%$ of reading (10.0mV - 999.9mV)
	Range 6	600mV ~ 8399mV, 8.40V ~ 10.00V, frequency DC, 15Hz – 100kHz
	Resolution	1mV, 0.01V

	Basic Accuracy	15Hz < f < 100KHz : $\pm 5\%$ of reading (0.01V -10.00V)
DISPLAY FIXED RANGE (<6% OF RANGE)		
Touch Voltage Display (RMS) (AC Only)	Range 1	N/A
	Resolution	N/A
	Additional Error	N/A
	Range 2	0.0mV ~ 7.8mV, frequency 15Hz - 1MHz
	Resolution	0.1mV
	Additional Error	15Hz \leq f \leq 30Hz : add $\pm(2\%$ of reading + 0.2% of range) to base accuracy 30Hz \leq f \leq 100KHz: add $\pm(2\%$ of reading + 0.2% of range) to base accuracy 100KHz \leq f \leq 1MHz : add $\pm(2\%$ of reading + 0.5% of range) to base accuracy
	Range 3	0.0mV ~ 31.5mV, frequency 15Hz - 1MHz
	Resolution	0.1mV
	Additional Error	15Hz \leq f \leq 30Hz : add $\pm(2\%$ of reading + 0.2% of range) to base accuracy 30Hz \leq f \leq 100KHz: add $\pm(2\%$ of reading + 0.2% of range) to base accuracy 100KHz \leq f \leq 1MHz : add $\pm(2\%$ of reading + 0.5% of range) to base accuracy
	Range 4	0.0mV ~ 126.0mV, frequency 15Hz - 1MHz
	Resolution	1mV
	Additional Error	15Hz \leq f \leq 30Hz : add $\pm(2\%$ of reading + 0.2% of range) to base accuracy 30Hz \leq f \leq 100KHz: add $\pm(2\%$ of reading + 0.2% of range) to base accuracy 100KHz \leq f \leq 1MHz : add $\pm(2\%$ of reading + 0.5% of range) to base accuracy
	Range 5	0.0mV ~ 504mV, frequency 15Hz - 1MHz
	Resolution	1mV

		Additional Error	15Hz ≤ f ≤ 30Hz : add ±(2% of reading + 0.2% of range) to base accuracy 30Hz ≤ f ≤ 100KHz: add ±(2% of reading + 0.2% of range) to base accuracy 100KHz ≤ f ≤ 1MHZ : add ±(2% of reading + 0.5% of range) to base accuracy
		Range 6	0.0mV ~ 600mV, frequency DC – 100KHz
		Resolution	1mV
		Additional Error	15Hz ≤ f ≤ 100KHz : add ±(2% of reading + 0.2% of range) to base accuracy
DISPLAY AUTO RANGE			
Touch Voltage Display	(DC Only)	Range 1	0.0mV ~ 32.0mV, DC
		Resolution	0.1mV
		Accuracy	DC : ±(2% of reading + 3counts) (>10.0mV)
		Range 2	28.0mV ~ 130.0mV, DC
		Resolution	0.1mV
		Accuracy	DC : ±(2% of reading + 3counts) (>10.0mV)
		Range 3	120.0mV ~ 525.0mV, DC
		Resolution	0.1mV
		Accuracy	DC : ±(2% of reading + 3counts) (>10.0mV)
		Range 4	400mV ~ 2100mV, DC
		Resolution	0.1mV, 1mV
		Accuracy	DC : ±(2% of reading + 3counts) (>10.0mV)
		Range 5	1800mV ~ 8400mV, DC
		Resolution	1mV
		Accuracy	DC : ±(2% of reading + 3counts) (>10.0mV)
		Range 6	8.00V ~ 10.00V, DC
		Resolution	1mV, 0.01V
		Accuracy	DC : ±5% of reading (0.01V -10.00V)
DISPLAY FIXED RANGE (>6% OF RANGE)			
Touch Voltage Display	(DC Only)	Range 1	0.0mV ~ 32.0mV, DC

	Resolution	0.1mV
	Base Accuracy	DC : $\pm(2\%$ of reading + 3counts) ($>10\text{mV}$)
	Range 2	7.8mV ~ 130.0mV, DC
	Resolution	0.1mV
	Base Accuracy	DC : $\pm(2\%$ of reading + 3counts) ($>10\text{mV}$)
	Range 3	31.5mV ~ 525.0mV, DC
	Resolution	0.1mV
	Base Accuracy	DC : $\pm(2\%$ of reading + 3counts) ($>10\text{mV}$)
	Range 4	126.0mV ~ 999.9mV, 1000mV ~ 2100mV, DC
	Resolution	1mV
	Base Accuracy	DC : $\pm(2\%$ of reading + 3counts) ($>10\text{mV}$)
	Range 5	504mV ~ 999.9mV, 1000mV ~ 8400mV, DC
	Resolution	1mV
	Base Accuracy	DC : $\pm(2\%$ of reading + 3counts) ($>10\text{mV}$)
	Range 6	600mV ~ 8399mV, 8.40mV ~ 10.00mV, DC
	Resolution	1mV, 0.01V
	Base Accuracy	DC : $\pm 5\%$ of reading (0.01V -10.00V)
DISPLAY FIXED RANGE (<6% OF RANGE)		
Touch Voltage Display (DC Only)	Range 1	N/A
	Resolution	N/A
	Additional Error	N/A
	Range 2	0.0mV ~ 7.8mV, DC
	Resolution	0.1mV
	Additional Error	DC: add $\pm(2\%$ of reading + 0.2% of range) to base accuracy

	Range 3	0.0mV ~ 31.5mV, DC
	Resolution	0.1mV
	Additional Error	DC: add $\pm(2\%$ of reading + 0.2% of range) to base accuracy
	Range 4	0.0mV ~ 126.0mV, DC
	Resolution	1mV
	Additional Error	DC: add $\pm(2\%$ of reading + 0.2% of range) to base accuracy
	Range 5	0.0mV ~ 504mV, DC
	Resolution	1mV
	Additional Error	DC: add $\pm(2\%$ of reading + 0.2% of range) to base accuracy
	Range 6	0.0mV ~ 600mV, DC
	Resolution	1mV
	Additional Error	DC: add $\pm(2\%$ of reading + 0.2% of range) to base accuracy
DISPLAY AUTO RANGE		
Touch Voltage Display (Peak) (AC+DC)	Range 1	0.0mV ~ 32.0mV, frequency DC, 15Hz – 1MHz
	Resolution	0.1mV
	Accuracy	DC: $\pm(2\%$ of reading + 2mV) , 15Hz \leq f < 1MHz: $\pm(10\%$ of reading + 2mV)
	Range 2	28.0mV ~ 130.0mV, frequency DC, 15Hz - 1MHz
	Resolution	0.1mV
	Accuracy	DC: $\pm(2\%$ of reading + 2mV) , 15Hz \leq f < 1MHz: $\pm(10\%$ of reading + 2mV)
	Range 3	120.0mV ~ 525.0mV, frequency DC, 15Hz - 1MHz
	Resolution	0.1mV
	Accuracy	DC: $\pm(2\%$ of reading + 2mV) , 15Hz \leq f < 1MHz: $\pm(10\%$ of reading + 2mV)
	Range 4	400mV ~ 999.9mV, 1000mV-2100mV, frequency DC, 15Hz - 1MHz
	Resolution	0.1mV, 1mV
	Accuracy	DC: $\pm(2\%$ of reading + 2mV) , 15Hz \leq f < 1MHz: $\pm(10\%$ of reading +

		2mV)
	Range 5	1800mV ~ 8400mV, frequency DC, 15Hz - 1MHz
	Resolution	1mV
	Accuracy	DC: $\pm(2\% \text{ of reading} + 3\text{counts})$ $15\text{Hz} \leq f < 1\text{MHz}$: $\pm(10\% \text{ of reading} + 2\text{mV})$
	Range 6	8000mV ~ 8399mV, 8.40V ~ 10.00V, frequency DC, 15Hz – 100KHz
	Resolution	1mV, 0.01V
	Accuracy	DC: $\pm(2\% \text{ of reading} + 3\text{counts})$ $15\text{Hz} \leq f < 100\text{KHz}$: $\pm(10\% \text{ of reading} + 2\text{counts})$
DISPLAY FIXED RANGE (>6% OF RANGE)		
Touch Voltage Display (Peak) (AC+DC)	Range 1	0.0mV ~ 32.0mV, frequency 15Hz - 1MHz
	Resolution	0.1mV
	Base Accuracy	DC: $\pm(2\% \text{ of reading} + 2\text{mV})$ $15\text{Hz} \leq f \leq 100\text{KHz}$: $\pm(10\% \text{ of reading} + 2\text{mV})$ $100\text{KHz} \leq f \leq 1\text{MHz}$: $\pm(10\% \text{ of reading} + 2\text{mV})$
	Range 2	7.8mV ~ 130.0mV, frequency 15Hz - 1MHz
	Resolution	0.1mV
	Base Accuracy	DC: $\pm(2\% \text{ of reading} + 2\text{mV})$ $15\text{Hz} \leq f \leq 100\text{KHz}$: $\pm(10\% \text{ of reading} + 2\text{mV})$ $100\text{KHz} \leq f \leq 1\text{MHz}$: $\pm(10\% \text{ of reading} + 2\text{mV})$
	Range 3	31.5mV ~ 525.0mV, frequency 15Hz - 1MHz
	Resolution	0.1mV
	Base Accuracy	DC: $\pm(2\% \text{ of reading} + 2\text{mV})$ $15\text{Hz} \leq f \leq 100\text{KHz}$: $\pm(10\% \text{ of reading} + 2\text{mV})$ $100\text{KHz} \leq f \leq 1\text{MHz}$: $\pm(10\% \text{ of reading} + 2\text{mV})$
	Range 4	126.0mV ~ 999.9mV, 1000mV ~ 2100mV, frequency 15Hz - 1MHz
	Resolution	1mV
	Base Accuracy	DC: $\pm(2\% \text{ of reading} + 2\text{mV})$ $15\text{Hz} \leq f \leq 100\text{KHz}$: $\pm(10\% \text{ of reading} + 2\text{mV})$ $100\text{KHz} \leq f \leq 1\text{MHz}$: $\pm(10\% \text{ of reading} + 2\text{mV})$

	Range 5	504mV ~ 999.9mV, 1000mV ~ 8400mV, frequency 15Hz - 1MHz
	Resolution	1mV
	Base Accuracy	DC: $\pm(2\%$ of reading + 2mV) $15\text{Hz} \leq f \leq 100\text{KHz}$: $\pm(10\%$ of reading + 2mV) $100\text{KHz} \leq f \leq 1\text{MHz}$: $\pm(10\%$ of reading + 2mV)
	Range 6	600mV ~ 8399mV, 8.40V ~ 10.00V, frequency 15Hz - 1MHz
	Resolution	1mV, 0.01V
	Base Accuracy	DC: $\pm(2\%$ of reading + 3counts) $15\text{Hz} \leq f < 100\text{KHz}$: $\pm(10\%$ of reading + 2counts)
DISPLAY FIXED RANGE (<6% OF RANGE)		
Touch Voltage Display (Peak) (AC+DC)	Range 1	N/A
	Resolution	N/A
	Additional Error	N/A
	Range 2	0.0mV ~ 7.8mV, frequency 15Hz - 1MHz
	Resolution	0.1mV
	Additional Error	DC: add $\pm(2\%$ of reading + 0.2% of range) to base accuracy $15\text{Hz} \leq f \leq 100\text{KHz}$: add $\pm(2\%$ of reading + 0.2% of range) to base accuracy $100\text{KHz} \leq f \leq 1\text{MHz}$: add $\pm(2\%$ of reading + 0.5% of range) to base accuracy
	Range 3	0.0mV ~ 31.5mV, frequency 15Hz - 1MHz
	Resolution	0.1mV
	Additional Error	DC: add $\pm(2\%$ of reading + 0.2% of range) to base accuracy $15\text{Hz} \leq f \leq 100\text{KHz}$: add $\pm(2\%$ of reading + 0.2% of range) to base accuracy $100\text{KHz} \leq f \leq 1\text{MHz}$: add $\pm(2\%$ of reading + 0.5% of range) to base accuracy
	Range 4	0.0mV ~ 126.0mV, frequency 15Hz - 1MHz
	Resolution	1mV

	Additional Error	DC: add $\pm(2\%$ of reading + 0.2% of range) to base accuracy 15Hz \leq f \leq 100KHz : add $\pm(2\%$ of reading + 0.2% of range) to base accuracy 100KHz \leq f \leq 1MHZ : add $\pm(2\%$ of reading + 0.5% of range) to base accuracy
	Range 5	0.0mV ~ 504mV, frequency 15Hz - 1MHz
	Resolution	1mV
	Additional Error	DC: add $\pm(2\%$ of reading + 0.2% of range) to base accuracy 15Hz \leq f \leq 100KHz : add $\pm(2\%$ of reading + 0.2% of range) to base accuracy 100KHz \leq f \leq 1MHZ : add $\pm(2\%$ of reading + 0.5% of range) to base accuracy
	Range 6	0.0mV ~ 600mV, frequency DC – 100KHz
	Resolution	1mV
	Additional Error	DC: add $\pm(2\%$ of reading + 0.2% of range) to base accuracy 15Hz \leq f \leq 100KHz : add $\pm(2\%$ of reading + 0.2% of range) to base accuracy
DISPLAY AUTO RANGE		
Touch Voltage Display (Peak) (AC Only)	Range 1	0.0mV ~ 32.0mV, frequency, 15Hz – 1MHz
	Resolution	0.1mV
	Accuracy	15Hz \leq f < 1MHz: $\pm(10\%$ of reading + 2mV)
	Range 2	28.0mV ~ 130.0mV, frequency, 15Hz - 1MHz
	Resolution	0.1mV
	Accuracy	15Hz \leq f < 1MHz: $\pm(10\%$ of reading + 2mV)
	Range 3	120.0mV ~ 525.0mV, frequency, 15Hz - 1MHz
	Resolution	0.1mV
	Accuracy	15Hz \leq f < 1MHz: $\pm(10\%$ of reading + 2mV)
	Range 4	400mV ~ 999.9mV, 1000mV-2100mV, frequency, 15Hz - 1MHz
	Resolution	0.1mV, 1mV

	Accuracy	15Hz ≤ f < 1MHz: ±(10% of reading + 2mV)
	Range 5	1800mV ~ 8400mV, frequency, 15Hz - 1MHz
	Resolution	1mV
	Accuracy	15Hz ≤ f < 1MHz: ±(10% of reading + 2mV)
	Range 6	8000mV ~ 8399mV, 8.40V ~ 10.00V, frequency, 15Hz – 100KHz
	Resolution	1mV, 0.01V
	Accuracy	15Hz ≤ f < 100KHz: ±(10% of reading + 2counts)
DISPLAY FIXED RANGE (>6% OF RANGE)		
Touch Voltage Display (Peak) (AC Only)	Range 1	0.0mV ~ 32.0mV, frequency 15Hz - 1MHz
	Resolution	0.1mV
	Base Accuracy	15Hz ≤ f ≤ 100KHz : ±(10% of reading + 2mV) 100KHz ≤ f ≤ 1MHZ : ±(10% of reading + 2mV)
	Range 2	7.8mV ~ 130.0mV, frequency 15Hz - 1MHz
	Resolution	0.1mV
	Base Accuracy	15Hz ≤ f ≤ 100KHz : ±(10% of reading + 2mV) 100KHz ≤ f ≤ 1MHZ : ±(10% of reading + 2mV)
	Range 3	31.5mV ~ 525.0mV, frequency 15Hz - 1MHz
	Resolution	0.1mV
	Base Accuracy	15Hz ≤ f ≤ 100KHz : ±(10% of reading + 2mV) 100KHz ≤ f ≤ 1MHZ : ±(10% of reading + 2mV)
		Range 4
	Resolution	1mV
	Base Accuracy	15Hz ≤ f ≤ 100KHz : ±(10% of reading + 2mV) 100KHz ≤ f ≤ 1MHZ : ±(10% of reading + 2mV)
	Range 5	504mV ~ 999.9mV, 1000mV ~ 8400mV, frequency 15Hz - 1MHz
	Resolution	1mV

	Base Accuracy	15Hz ≤ f ≤ 100KHz : ±(10% of reading + 2mV) 100KHz ≤ f ≤ 1MHZ : ±(10% of reading + 2mV)
	Range 6	600mV ~ 8399mV, 8.40V ~ 10.00V, frequency 15Hz - 1MHz
	Resolution	1mV, 0.01V
	Base Accuracy	15Hz ≤ f < 100KHz: ±(10% of reading + 2counts)
DISPLAY FIXED RANGE (<6% OF RANGE)		
Touch Voltage Display (Peak) (AC Only)	Range 1	N/A
	Resolution	N/A
	Additional Error	N/A
	Range 2	0.0mV ~ 7.8mV, frequency 15Hz - 1MHz
	Resolution	0.1mV
	Additional Error	15Hz ≤ f ≤ 100KHz : add ±(2% of reading + 0.2% of range) to base accuracy 100KHz ≤ f ≤ 1MHZ : add ±(2% of reading + 0.5% of range) to base accuracy
	Range 3	0.0mV ~ 31.5mV, frequency 15Hz - 1MHz
	Resolution	0.1mV
	Additional Error	15Hz ≤ f ≤ 100KHz : add ±(2% of reading + 0.2% of range) to base accuracy 100KHz ≤ f ≤ 1MHZ : add ±(2% of reading + 0.5% of range) to base accuracy
	Range 4	0.0mV ~ 126.0mV, frequency 15Hz - 1MHz
	Resolution	1mV
	Additional Error	15Hz ≤ f ≤ 100KHz : add ±(2% of reading + 0.2% of range) to base accuracy 100KHz ≤ f ≤ 1MHZ : add ±(2% of reading + 0.5% of range) to base accuracy
	Range 5	0.0mV ~ 504mV, frequency 15Hz - 1MHz
	Resolution	1mV

Additional Error	$15\text{Hz} \leq f \leq 100\text{KHz}$: add $\pm(2\%$ of reading + 0.2% of range) to base accuracy $100\text{KHz} \leq f \leq 1\text{MHZ}$: add $\pm(2\%$ of reading + 0.5% of range) to base accuracy
Range 6	0.0mV ~ 600mV, frequency DC – 100KHz
Resolution	1mV
Additional Error	$15\text{Hz} \leq f \leq 100\text{KHz}$: add $\pm(2\%$ of reading + 0.2% of range) to base accuracy

Index

AC Withstand.....	42, 60, 62, 67, 69, 70, 72, 73, 75, 99, 101
Adapter Box.....	10, 29, 32, 91, 92, 211
Arc.....	3, 15, 61, 63, 64, 70, 71, 101, 115, 118, 121, 122
Benefits.....	8
Breakdown.....	3, 4, 101
Calibration.....	10, 30, 188, 197, 198
Calibration Alert.....	33, 37, 39
Calibration Procedure.....	188
Charge-LO.....	15, 18, 61, 64, 71, 72, 73, 101, 112, 113, 115, 118
Connected Steps.....	55, 58, 66, 67, 69, 94, 95, 96, 97, 98, 112, 114, 117, 121, 127, 149, 159, 173, 189
Continuity Test.....	61, 73, 74, 76, 112, 142
Controls.....	12, 15, 28, 30, 31, 33, 53, 57, 77, 94, 130, 175
Controls.....	15
DC Withstand.....	42, 55, 59, 61, 62, 66, 70, 71, 72, 99, 101
Default Parameters.....	62, 63, 67, 115, 117
Delay.....	18, 22, 23, 60, 64, 65, 72, 77, 79, 100, 107, 115, 118, 122, 154
Dielectric Withstand Test.....	63, 64, 67, 113, 114, 115, 117, 118, 121, 122, 123, 124, 127, 150, 153, 154, 173, 174, 177
Discharge.....	7, 16
DUT.....	7, 8, 40, 61, 97, 197, 198
Dwell.....	16, 19, 20, 22, 23, 60, 63, 64, 65, 70, 71, 74, 76, 77, 100, 115, 118, 122, 154
Edit Parameters.....	35, 38, 53, 55, 57, 62, 66, 67, 71, 73, 74, 76, 121, 122, 123, 124, 140, 141, 143
ESD.....	6, 7
Ethernet Card	136, 161, 162, 163, 164, 165, 166, 167, 171, 173, 174, 175, 212, 213
Exit Key.....	68
Fail Stop.....	45, 53, 58, 94, 95, 114, 121, 125
Features.....	8, 143, 150
File	
Create.....	57, 58, 66
Recall.....	43
Setup.....	57, 58, 66, 68
Frequency....	3, 4, 15, 16, 19, 24, 25, 26, 61, 63, 64, 70, 74, 76, 83, 87, 115, 117, 118, 122, 123, 177, 215, 216, 217, 218, 219, 220, 221, 223, 224, 225, 226, 227, 228, 229, 230, 231, 232, 233, 234, 235, 236, 237, 238, 239, 240, 241, 242, 243, 244
Glossary.....	3
GPIOB	21, 65, 109, 110, 111, 112, 126, 132, 135, 136, 139, 141, 143, 161, 176, 212, 213
HI-Limit.....	60, 63, 64, 70, 71, 72, 74, 76, 101, 115, 118, 122
Interlock.....	21, 30, 92, 101, 107, 108, 126, 127, 211
LCD.....	28, 114, 127, 140, 141, 143, 211
Leakage.....	4, 8, 13, 40, 61
Applied Part.....	32, 81
Earth.....	77, 78, 81
Leakage-HI.....	60, 65, 77, 78, 79, 115, 118

Leakage-LO	60, 65, 77, 79, 115, 118
Line	32, 79, 83, 87, 99
Limits	101
Lockout	92, 102, 107
LO-Limit	15, 19, 20, 60, 63, 64, 70, 73, 101, 115, 118, 122, 177
Max-Lmt.....	61
Measuring Device	32, 60, 79, 81, 83, 86, 87
Medical Restrictions.....	7
Memory..	21, 73, 97, 102, 107, 111, 112, 114, 127, 128, 130, 132, 138, 139, 140, 141, 143, 144, 145, 146, 151, 153, 155, 156, 158
Menu.	33, 34, 53, 54, 66, 68, 69, 94, 125, 137, 138, 140, 144, 150, 151, 152, 155, 157, 158, 164, 166, 179
My Menu	8, 28, 51, 53, 89, 90
Offset	8, 93, 112, 115, 117, 137
Operator.....	6, 7, 8, 12, 14, 21, 29, 32, 40, 82, 106, 162
Options	21, 31, 39, 67, 109, 112, 136, 145, 164, 165
Parameters	
System Parameters	124, 159
Test Parameters	42, 54, 55, 59, 62, 93, 109, 111, 113, 159
PLC.....	21, 39, 41, 65, 106, 125, 137, 138, 139, 140, 141
Power.....	4, 6, 12
Power Factor	4, 22, 23, 77, 103, 154
Printing.....	158
Probe-HI	32, 81, 82, 83, 87, 116, 118, 123, 198, 199, 200, 201, 202, 203, 204, 205, 206, 207, 208, 209
Probe-LO ...	32, 81, 82, 83, 87, 116, 118, 123, 198, 199, 200, 201, 202, 203, 204, 205, 206, 207, 208, 209
Programming	33, 54
Ramp-HI	15, 61, 64, 71, 72, 115, 123
Ramping	100
Rear Panel Controls.....	12, 30, 31
Receptacle.....	30, 80, 105
Regulation.....	16, 19
Remote	21, 30, 39, 41, 65, 92, 100, 101, 105, 106, 107, 108, 109, 111, 125, 126, 127, 137, 138, 139, 140, 161, 176
Remote Interlock.....	92, 101, 107, 108, 126
Resistance	4, 6, 12
Return	13
RS-232.....	21, 30, 109, 112, 129, 132, 161, 173, 176, 213
Run Test	65, 76, 77, 99, 138, 140
Safety.....	i, ii, 3, 5, 7, 12, 21
Safety Symbols.....	3
Scanner	28, 31, 63, 64, 93, 115, 117, 123, 124, 136, 137, 142, 143, 161, 173, 212, 213
Channel	71, 72, 74, 76, 93
Control Board.....	212
Internal.....	136
Option	136
Parameter	67

Setup	61, 66, 93
Security	21, 33, 42, 43, 47, 59, 65, 89, 95, 96
Sequence	58, 97
Service	1, 3, 5, 10, 11, 132, 188
Service Interval	5
Setup	12, 28, 34
AC Withstand	69
DC Withstand	70
DUT-HV	42, 62, 197, 198
File	113, 121, 126
Ground Continuity	73, 75
Insulation Resistance	72
Leakage Current	79
Run Test	76
Scanner	61, 93, 136
Setup DUT-HV	124
Setup File	113, 121, 126
Setup System	137, 144, 158, 166, 167
System	33, 65, 137, 158
Test	29, 53, 54, 55, 57, 59, 66, 67, 68, 69, 70, 72, 73, 75, 76, 79
Short	22, 23, 56, 58, 74, 76, 87, 95, 101, 103, 142, 196, 198
Single Step	45, 94, 95, 96, 125
Smart GFI	21, 39, 40, 65, 125
Specifications	15
Test Screen	159
Test Station	6, 7
Trip Point	61
UL	179
Unpacking	9
Verification	83, 87, 179, 180, 181, 182, 183, 184, 185, 186, 187
AC Hipot	183
Continuity	179
DC Hipot	184
Ground Bond	181
IR	186
Warranty	1, 2, 188
Warranty Policies	1