



Operation & Service Manual

Model 446, 448 • V1.01

Model 446 (AC/DC Hipot with IR and Ground Bond Tester)
Model 448 (500VA AC/DC Hipot with IR and Ground Bond Tester)

Printed December 7, 2021



DECLARATION OF CONFORMITY



Manufacturer: Ikonix
Address: 28105 N. Keith Drive
Lake Forest, IL 60045
USA

Product Name: SCI 440 Series

Model Number: 446

Conforms to the following Standards:

Safety: UL 61010-1:2012
CAN/CSA-C22.2 NO. 61010-1-12

EMC: EN 61326-1:2013 Class A
EN 55011:2009+A1:2010 Group 1, Class A,
EN 61000-3-2:2014/IEC 61000-3-2:2014,
EN 61000-3-3:2013/ IEC 61000-3-3:2013,
EN 61326-1:2013(Industrial Locations)
EN 61000-4-2:2009/IEC 61000-4-2:2008
EN 61000-4-3:2006+A1:2008+A2:2010,
IEC 61000-4-3:2006+A1:2007+A2:2010,
EN 61000-4-4:2012/IEC 61000-4-4:2012,
EN 61000-4-5:2006 /IEC 61000-4-5:2005
EN 61000-4-6:2014/IEC 61000-4-6:2013,
EN 61000-4-8:2010/IEC 61000-4-8:2009,
EN 61000-4-11:2004/IEC 61000-4-11:2004

Supplementary Information:

*The product herewith complies with the requirements of the **Low Voltage Directive 2014/35/EU** and the **EMC Directive 2014/30/EU** and the **RoHS Directive 2015/863/EU** with respect to the following substances: Lead (Pb), Mercury (Hg), Cadmium (Cd), Hexavalent chromium (Cr (VI)), Polybrominated biphenyls (PBB), Polybrominated diphenyl ethers (PBDE), Deca-BDE, Bis(2-ethylhexyl) phthalate, Dibutyl phthalate, Benzyl butyl phthalate and Diisobutyl phthalate included.*

Last two digits of the year the CE mark was first affixed: 16

The technical file and other documentation are on file with Ikonix

Joseph Guerriero
President
Ikonix
Lake Forest, Illinois USA
January 29, 2021

DECLARATION OF CONFORMITY



Manufacturer: Ikonix
Address: 28105 N. Keith Drive
Lake Forest, IL 60045
USA
Product Name: SCI 440 Series
Model Number: 448

Conforms to the following Standards:

Safety: UL 61010-1:2012
CAN/CSA-C22.2 NO. 61010-1-12

EMC: EN 61326-1:2013 Class A
EN 61000-3-3:2013/ IEC 61000-3-3:2013
EN 61326-1:2013(Industrial Locations)
EN 61000-4-2:2009/ IEC 61000-4-2:2008
EN 61000-4-3:2006+A1:2008+A2:2010/
IEC 61000-4-3:2006 +A1:2007+A2:2010
EN 61000-4-4:2012/ IEC 61000-4-4:2012
EN 61000-4-5:2014/ IEC 61000-4-5:2014
EN 61000-4-6:2014/ IEC 61000-4-6:2013
EN 61000-4-8:2010/ IEC 61000-4-8:2009
EN 61000-4-11:2004/ IEC 61000-4-11:2004

Supplementary Information:

*The product herewith complies with the requirements of the **Low Voltage Directive 2014/35/EU** and the **EMC Directive 2014/30/EU** and the **RoHS Directive 2015/863/EU** with respect to the following substances: Lead (Pb), Mercury (Hg), Cadmium (Cd), Hexavalent chromium (Cr (VI)), Polybrominated biphenyls (PBB), Polybrominated diphenyl ethers (PBDE), Deca-BDE, Bis(2-ethylhexyl) phthalate, Dibutyl phthalate, Benzyl butyl phthalate and Diisobutyl phthalate included.*

Last two digits of the year the CE mark was first affixed: 16

The technical file and other documentation are on file with Ikonix

Joseph Guerriero
President
Ikonix
Lake Forest, Illinois USA
January 29, 2021

WARRANTY

Ikonix, certifies that the tester listed in this manual meets or exceeds published manufacturing specifications. This tester was calibrated using standards that are traceable to the National Institute of Standards and Technology (NIST).

Your new tester is warranted to be free from defects in workmanship and material for a period of (5) years from date of shipment.

We aim to provide an amazing experience and quality testers that last a long time. If you're not satisfied with your tester, return it within 45 days for a full refund. Calibrate annually with us or one of our authorized partners and we'll extend your warranty an additional year for the service life of your tester, and at least five years after discontinuation. If it breaks during that time, we promise to fix it for free (unless abuse or excessive damage is present). When your tester reaches the end of its service life, we'll responsibly recycle it and give you a discount on a replacement.

Ikonix recommends that your tester be calibrated on a twelve-month cycle. A return material authorization (RMA) must be obtained from Ikonix. To obtain an RMA please visit www.hipot.com or contact our Customer Support Center at 1-847-932-3662. Damages sustained as a result of improper packaging will not be honored. Transportation costs for the return of the tester for warranty service must be prepaid by the customer. Ikonix will assume the return freight costs when returning the tester to the customer. The return method will be at the discretion of Ikonix.

Except as provided, herein Ikonix makes no warranties to the purchaser of this tester and all other warranties, expressed or implied (including, without limitation, merchantability or fitness for a particular purpose), are hereby excluded, disclaimed and waived.

Any non-authorized modifications, tampering or physical damage will void your warranty. Elimination of any connections in the earth grounding system or bypassing any safety systems will void this warranty. This warranty does not cover accessories not of Ikonix manufacture. Parts used must be parts that are recommended by Ikonix as an acceptable specified part. Use of non-authorized parts in the repair of this tester will void the warranty.

TABLE OF CONTENTS

SAFETY PRECAUTIONS	6
Front Panel Controls	7
Rear Panel Controls	8
Setup Instructions	10
Power-Up Sequence	10
Getting To Know Your Tester	11
Working With Memories.....	11
Perform Test Screen	11
Program a Memory	12
Type AC	13
Type DC.....	17
Type IR.....	20
Type GND	24
System Parameter Descriptions	30
Setting System Parameters	31
Using The Display	35
Test Mode Display.....	35
Failure Mode Displays.....	36
Error Messages.....	39
Reviewing Test Results For Multistep Sequences	40
Using The Remote I/O	41
Signals On Remote I/O	42
Remote Memory Bit Selection	43
Using The Tester Accessories	44
Using The Test Leads	44
Appendix A - Installation And Test Operator Information	45
Installation	45
1. Unpacking and Inspection	45
2. Safe Lifting and Carrying Instructions.....	45
3. Contents Of The Carton	45
4. Preparation For Use	46
5. Power Cable	46
Operating Environment.....	46
Storage and Shipment	47
Packaging	47
Test Operator Safety Considerations	48
1. Qualifications	48
2. Safety Procedures.....	48
3. Dress	48
4. Medical Restrictions	48
5. Test Procedures	48
6. Test Station	49
Appendix B - 440 Series Tester Specifications	50
Appendix C - 440 Series Options	52
Appendix D - Remote Bus Interface: USB	53
Appendix E - Replacement Part List - 440 Series	61
Appendix F - Service and Maintenance	63
Appendix G - Calibration Procedure	64

SAFETY PRECAUTIONS

General

This product and its related documentation must be reviewed for familiarization with safety markings and instructions before operation. This product is a Safety Class I tester (provided with a protective earth terminal).

Before applying power, verify installed fuse and input voltage supplied to tester are within specifications.



INSTRUCTION MANUAL SYMBOL. PLEASE REFER TO THE INSTRUCTION MANUAL FOR SPECIFIC WARNING OR CAUTION INFORMATION TO AVOID PERSONAL INJURY OR DAMAGE TO THE PRODUCT.



INDICATES HAZARDOUS VOLTAGES MAY BE PRESENT.



CHASSIS GROUND SYMBOL.

WARNING

CALLS ATTENTION TO A PROCEDURE, PRACTICE, OR CONDITION, THAT COULD POSSIBLY CAUSE BODILY INJURY OR DEATH.

CAUTION

Calls attention to a procedure, practice, or condition that could cause damage to equipment or permanent loss of data.

WARNING

A HIPOT PRODUCES VOLTAGES AND CURRENTS WHICH CAN CAUSE HARMFUL OR FATAL ELECTRIC SHOCK. TO PREVENT ACCIDENTAL INJURY OR DEATH, THESE SAFETY PROCEDURES MUST BE STRICTLY OBSERVED WHEN HANDLING AND USING THE TESTER.

FRONT PANEL CONTROLS

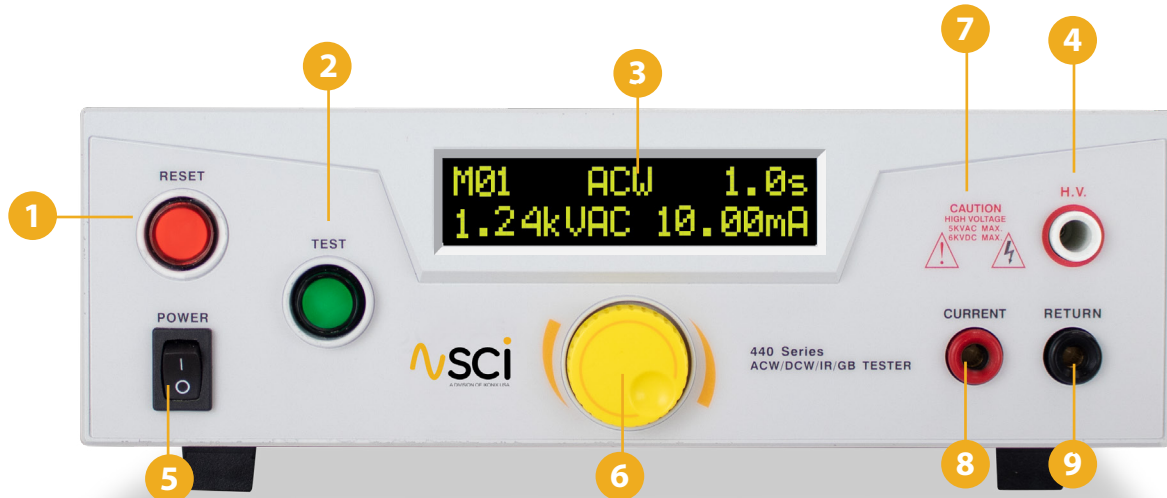

- 1 RESET BUTTON** - This is a momentary contact switch used to reset the tester. If an out-of-range reading is detected during a test, the red failure lamp within the button will light. To reset the system for the next test, press and release this button. This button may also be used to abort a test in progress.
- 2 TEST BUTTON** - This is a momentary contact switch used to start a test. Press the green button to turn on the high voltage output when in test mode. The indicator lamp within the button will light when the test ends with pass condition.
- 3 LCD DISPLAY** - The Liquid Crystal Display is the main readout for the operator and programmer of the test settings and test results.
- 4 HIGH VOLTAGE OUTPUT JACK** - Use this jack for the connection of the detachable high voltage test lead or the adapter box high voltage connector.
- 5 POWER SWITCH** - Rocker-style switch with international ON (|) and OFF (0) markings.
- 6 ROTARY KNOB** - Use this knob to advance forward/backward through the setup menus and to setup system and test parameters.
- 7 HIGH VOLTAGE ARROW (LED INDICATOR)** - This indicator flashes to warn the operator that high voltage is present at the high voltage output terminal.
- 8 CURRENT OUTPUT TERMINAL** - Connector used to attach the high current output lead, adapter box high current lead or test fixture high current lead to the instrument. This connection provides the output current for the ground bond.
- 9 RETURN TERMINAL** - Connector used to attach the return test lead, adapter box return lead or test fixture return lead to the instrument. This connection provides the return current path.

REAR PANEL CONTROLS 446



- 1 HIGH VOLTAGE OUTPUT JACK** - Use this jack for the connection of the detachable high voltage test lead or the high voltage adapter box.
- 2 RETURN TERMINAL** - Connector used to attach the return test lead, adapter box return lead or test fixture return lead to the instrument. This connection provides the return current path.
- 3 CURRENT OUTPUT TERMINAL** - Connector used to attach the high current output lead, adapter box high current lead, or test fixture high current lead to the instrument. This connection provides the output current for the ground bond.
- 4 HIGH VOLTAGE ARROW (LED INDICATOR)** - This indicator flashes to warn the operator that high voltage is present at the high voltage output terminal.
- 5 CALIBRATION ENABLE KEY** - To enter the calibration mode press this key while the tester is being powered on.
- 6 USB CONNECTOR** - USB port for serial communication. Refer to Remote Bus Interface section page 50.
- 7 REMOTE OUTPUT** - 9 pin D subminiature female connector for monitoring PASS, FAIL, and PROCESSING output relay signals.
- 8 REMOTE INPUT** - 9 pin D subminiature male connector for remote control of test, reset, and interlock functions as well as remote memory tests selection.
- 9 CHASSIS GROUND EARTH TERMINAL** - This safety ground terminal should be connected to a good earth ground before operation.
- 10 FUSE RECEPTACLE** - To change the fuse, unplug the power (mains) cord, push and turn the fuse receptacle counter-clockwise. This will expose the fuse compartment. Please replace the fuse with one of the proper rating.
- 11 INPUT POWER RECEPTACLE** - Standard IEC 320 connector for connection to a standard NEMA style line power mains cord.

REAR PANEL CONTROLS 448

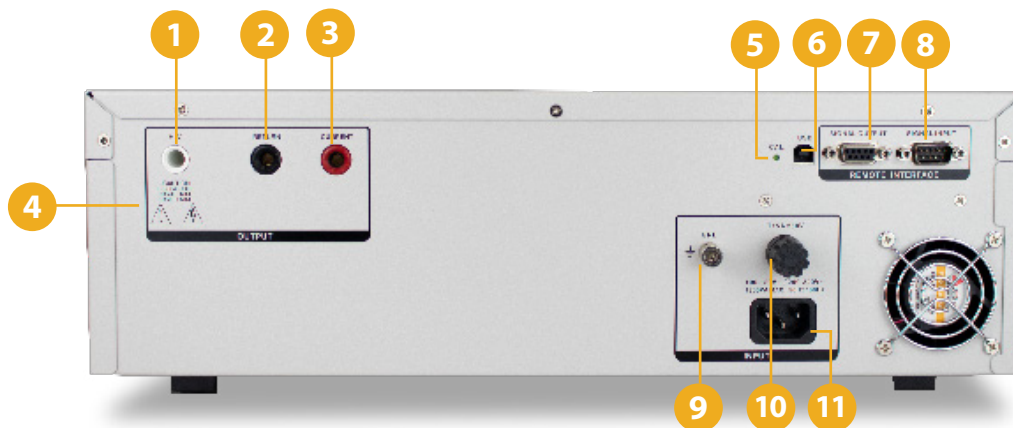

- 1 HIGH VOLTAGE OUTPUT JACK** - Use this jack for the connection of the detachable high voltage test lead or the high voltage adapter box.
- 2 RETURN TERMINAL** - Connector used to attach the return test lead, adapter box return lead or test fixture return lead to the instrument. This connection provides the return current path.
- 3 CURRENT OUTPUT TERMINAL** - Connector used to attach the high current output lead, adapter box high current lead, or test fixture high current lead to the instrument. This connection provides the output current for the ground bond.
- 4 HIGH VOLTAGE ARROW (LED INDICATOR)** - This indicator flashes to warn the operator that high voltage is present at the high voltage output terminal.
- 5 CALIBRATION ENABLE KEY** - To enter the calibration mode press this key while the tester is being powered on.
- 6 USB CONNECTOR** - USB port for serial communication. Refer to Remote Bus Interface section page 50.
- 7 REMOTE OUTPUT** - 9 pin D subminiature female connector for monitoring PASS, FAIL, and PROCESSING output relay signals.
- 8 REMOTE INPUT** - 9 pin D subminiature male connector for remote control of test, reset, and interlock functions as well as remote memory tests selection.
- 9 CHASSIS GROUND EARTH TERMINAL** - This safety ground terminal should be connected to a good earth ground before operation.
- 10 FUSE RECEPTACLE** - To change the fuse, unplug the power (mains) cord, push and turn the fuse receptacle counter-clockwise. This will expose the fuse compartment. Please replace the fuse with one of the proper rating.
- 11 INPUT POWER RECEPTACLE** - Standard IEC 320 connector for connection to a standard NEMA style line power mains cord.

SETUP INSTRUCTIONS

Power-Up Sequence

1. Check to be sure the correct input line cord is used.
2. Connect the power input plug into its socket on the rear panel of the tester. The SCI 440 Series Testers have an automatic input voltage range selection.
3. Connect the male end of the plug to the grounded AC outlet.



WARNING

PLEASE BE SURE THAT THE SAFETY GROUND ON THE POWER LINE CORD IS NOT DEFEATED AND THAT YOU ARE CONNECTING TO A GROUNDED POWER SOURCE. ALSO, CONNECT THE REAR PANEL CHASSIS GROUND FOR ADDITIONAL SAFETY.

4. Connect the Interlock Disable key to the Signal Input connector on the back panel of the tester. This is required in order to run a test.



5. Turn on the POWER switch located on the lower left hand side of the front panel. Upon powering the tester up, a POWER ON SELF TEST (POST) will automatically be performed. This test will check for the condition of the RAM chips, PCBs and other critical components. In addition, the display will show the following message, with the actual model number and software version number.



6. The tester will recall the last memory program that was active and the display will show the parameters that were programmed into that memory. The tester is now ready for operation.

GETTING TO KNOW YOUR TESTER

Working with Memories

The SCI 440 series testers are equipped with 20 memory programs numbered 1 through 20. Each memory can be connected sequentially to the next consecutive memory. Only one test type can be selected for each memory location. However, all 20 memory locations can be programmed and the parameters will be saved in each memory. The tests loaded in each memory location can be executed one at a time or as a sequence.

Perform Test Screen

The Perform Test Screen displays the following parameters:

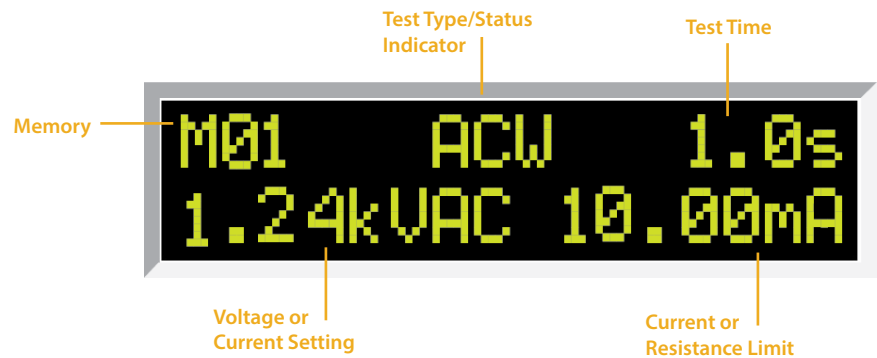

Display	Description
	AC Hipot test display
	DC Hipot test display
	Insulation Resistance test display
	Ground Bond test display

GETTING TO KNOW YOUR TESTER

Program a Memory

1. M01 DCW 1.0s
1.24kVAC 5mA



Home Screen

2. BACK <M01> M02
1.24kVAC 5mA



Turn the yellow rotary knob to scroll to M01 to edit Memory 1. (M02=Memory 2, etc.)

3. M01 DCW 1.0s
1.24kVAC 5mA



When M01 is selected, press the yellow knob to recall Memory 1.

4. BACK <TYPE> VOLT
1.24kVAC 5mA



Press the knob again to edit Memory 1. The first parameter that will be selected is TYPE.

Continue to edit each parameter as needed for Memory 1.

Go Back to the Main Menu

1. SCTY <PLC> BACK
OFF



Turn the yellow knob to scroll to BACK in order to return to the Main Menu.

2. PLC <BACK> M1
EXIT TO MAIN



When BACK is selected, press the knob. You will be returned to the Main Menu

3. M01 ACW 0.0s
0.00kVAC 100mΩ



Main Menu.

GETTING TO KNOW YOUR TESTER

Program a Memory: Type AC

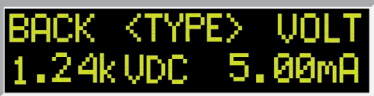
1. 

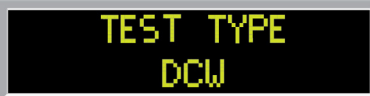

Turn the yellow rotary knob to scroll to desired parameter to edit TYPE.

2. 



When TYPE is selected, press the rotary knob to edit the Test Type. The options will blink.

3. 



Turn the rotary knob to change the Test Type: ACW, DCW, IR or GB.

4. 



Press the rotary knob to select the Test Type.

5. 



You will be returned to the previous menu.

Program a Memory: Change Voltage (AC)

1. 



Turn the yellow rotary knob to scroll to desired parameter to edit VOLT.

2. 



When VOLT is selected, press the rotary knob to edit the Voltage. The first digit of Voltage will blink.

3. 



Turn the rotary knob to change the Voltage setting for each digit.

4. 



Press the rotary knob to select the setting and move to the next digit.

5. 



When done, you will be returned to the previous menu.

GETTING TO KNOW YOUR TESTER

Program a Memory: Change HI-Limit (AC)

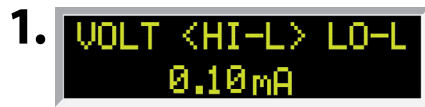

Turn the yellow rotary knob to scroll to desired parameter to edit HI-L.



When HI-L is selected, press the rotary knob to edit the HI-Limit. The first digit of HI-Limit will blink.



Turn the rotary knob to change the HI-Limit setting for each digit.



Press the rotary knob to select the setting and move to the next digit.



When done, you will be returned to the previous menu.

Program a Memory: Change LO-Limit (AC)



Turn the yellow rotary knob to scroll to desired parameter to edit LO-L.



When LO-L is selected, press the rotary knob to edit the LO-Limit. The first digit of LO-Limit will blink.



Turn the rotary knob to change the LO-Limit setting for each digit.



Press the rotary knob to select the setting and move to the next digit.



When done, you will be returned to the previous menu.

GETTING TO KNOW YOUR TESTER

Program a Memory: Change Ramp (AC)



Turn the yellow rotary knob to scroll to desired parameter to edit RAMP.



When RAMP is selected, press the rotary knob to edit the Ramp Time. The first digit of Ramp Time will blink.



Turn the rotary knob to change the Ramp Time for each digit.



Press the rotary knob to select the setting and move to the next digit.



When done, you will be returned to the previous menu.

Program a Memory: Change Dwell (AC)



Turn the yellow rotary knob to scroll to desired parameter to edit DWLL.



When DWLL is selected, press the rotary knob to edit the Dwell Time. The first digit of Dwell Time will blink.



Turn the rotary knob to change the Ramp Time for each digit.



Press the rotary knob to select the setting and move to the next digit.



When done, you will be returned to the previous menu.

GETTING TO KNOW YOUR TESTER

Program a Memory: Change Frequency (AC)



Turn the yellow rotary knob to scroll to desired parameter to edit FREQ.



When FREQ is selected, press the rotary knob to edit the Frequency. The options will blink.



Turn the rotary knob to change the Frequency setting: 50Hz or 60Hz.



Press the rotary knob to select the setting.



You will be returned to the previous menu.

Program a Memory: Change Connect (AC)



Turn the yellow rotary knob to scroll to desired parameter to edit CONN.



When CONN is selected, press the rotary knob to edit the Connect Setting. The options will blink.



Turn the rotary knob to change the Connect setting: ON or OFF.



Press the rotary knob to select the setting and move to the next digit.



When done, you will be returned to the previous menu.

GETTING TO KNOW YOUR TESTER

Program a Memory: Type DC

1. 



Turn the yellow rotary knob to scroll to desired parameter to edit TYPE.

2. 



When TYPE is selected, press the rotary knob to edit the frequency. The options will blink.

3. 



Turn the rotary knob to change the Test Type: ACW, DCW or IR.

4. 



Press the rotary knob to select the setting.

5. 



You will be returned to the previous menu.

Program a Memory: Change Voltage (DC)

1. 



Turn the yellow rotary knob to scroll to desired parameter to edit VOLT.

2. 



When VOLT is selected, press the rotary knob to edit the Voltage. The first digit of Voltage will blink.

3. 



Turn the rotary knob to change the Voltage setting for each digit.

4. 



Press the rotary knob to select the setting and move to the next digit.

5. 



When done, you will be returned to the previous menu.

GETTING TO KNOW YOUR TESTER

Program a Memory: Change HI-Limit (DC)



Turn the yellow rotary knob to scroll to desired parameter to edit HI-L.

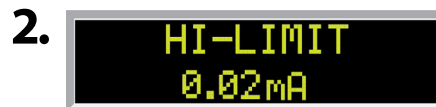

When HI-L is selected, press the rotary knob to edit the HI-Limit. The first digit of HI-Limit will blink.



Turn the rotary knob to change the HI-Limit setting for each digit.



Press the rotary knob to select the setting and move to the next digit.



When done, you will be returned to the previous menu.

Program a Memory: Change LO-Limit (DC)



Turn the yellow rotary knob to scroll to desired parameter to edit LO-L.



When LO-L is selected, press the rotary knob to edit the LO-Limit. The first digit of LO-Limit will blink.



Turn the rotary knob to change the LO-Limit setting for each digit.



Press the rotary knob to select the setting and move to the next digit.



When done, you will be returned to the previous menu.

GETTING TO KNOW YOUR TESTER

Program a Memory: Change Ramp (DC)



Turn the yellow rotary knob to scroll to desired parameter to edit RAMP.



When RAMP is selected, press the rotary knob to edit the Ramp Time. The first digit of Ramp Time will blink.



Turn the rotary knob to change the Ramp Time for each digit.



Press the rotary knob to select the setting and move to the next digit.



When done, you will be returned to the previous menu.

Program a Memory: Change Dwell (DC)



Turn the yellow rotary knob to scroll to desired parameter to edit DWLL.



When DWLL is selected, press the rotary knob to edit the Dwell Time. The first digit of Dwell Time will blink.



Turn the rotary knob to change the Ramp Time for each digit.

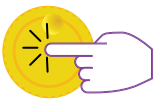

Press the rotary knob to select the setting and move to the next digit.



When done, you will be returned to the previous menu.

GETTING TO KNOW YOUR TESTER

Program a Memory: Change Connect (DC)

1. DWLL <CONN> BACK
OFF



Turn the yellow rotary knob to scroll to desired parameter to edit CONN.

2. CONNECT
OFF

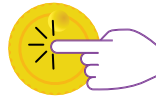

When CONN is selected, press the rotary knob to edit the Connect Setting. The options will blink.

3. CONNECT
ON



Turn the rotary knob to change the Connect setting: ON or OFF.

4. CONNECT
ON



Press the rotary knob to select the setting and move to the next digit.

5. DWLL <CONN> BACK
OFF



When done, you will be returned to the previous menu.

Program a Memory: Type IR

1. BACK <TYPE> VOLT
0.00kVAC 5.00mA



Turn the yellow rotary knob to scroll to desired parameter to edit TYPE.

2. TEST TYPE
ACW

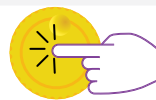

When TYPE is selected, press the rotary knob to edit the Dwell Time. The first digit of Dwell Time will blink.

3. TEST TYPE
IR



Turn the rotary knob to change the Test Type: ACW, DCW or IR.

4. TEST TYPE
IR



Press the rotary knob to select the setting and move to the next digit.

5. BACK <TYPE> VOLT
IR



When done, you will be returned to the previous menu.

GETTING TO KNOW YOUR TESTER

Program a Memory: Change Voltage (IR)

1. TYPE <VOLT> HI-L
500VDC



Turn the yellow rotary knob to scroll to desired parameter to edit VOLT.

2. VOLTAGE
500VDC

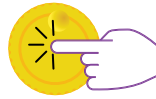

When VOLT is selected, press the rotary knob to edit the Connect Setting. The options will blink.

3. VOLTAGE
1000VDC



Turn the rotary knob to change the Voltage setting for each digit.

4. VOLTAGE
1000VDC



Press the rotary knob to select the setting and move to the next digit.

5. TYPE <VOLT> HI-L
1000VDC



When done, you will be returned to the previous menu.

Program a Memory: Change HI-Limit (IR)

1. VOLT <HI-L> LO-L
0M Ω



Turn the yellow rotary knob to scroll to desired parameter to edit HI-L.

2. HI-LIMIT
0M Ω



When HI-L is selected, press the rotary knob to edit the HI-Limit. The first digit of HI-Limit will blink.

3. HI-LIMIT
1M Ω



Turn the rotary knob to change the HI-Limit for each digit.

4. HI-LIMIT
1M Ω



Press the rotary knob to select the setting and move to the next digit.

5. VOLT <HI-L> LO-L
1M Ω



When done, you will be returned to the previous menu.

GETTING TO KNOW YOUR TESTER

Program a Memory: Change LO-Limit (IR)

1. HI-L <LO-L> RAMP
1M Ω



Turn the yellow rotary knob to scroll to desired parameter to edit LO-L.

2. LO-LIMIT
1M Ω

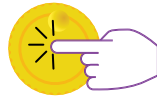

When LO-L is selected. Press the rotary knob to edit the LO-Limit. The first digit of LO-Limit will blink.

3. LO-LIMIT
0M Ω



Turn the rotary knob to change the LO-Limit setting for each digit.

4. LO-LIMIT
0M Ω



Press the rotary knob to select the setting and move to the next digit.

5. HI-L <LO-L> RAMP
0M Ω



When done, you will be returned to the previous menu.

Program A Memory: Change Ramp (IR)

1. LO-L <RAMP> DLAY
0.1s



Turn the yellow rotary knob to scroll to desired parameter to edit RAMP.

2. RAMP
000.1s



When RAMP is selected. Press the rotary knob to edit the Ramp Time. The first digit of Ramp Time will blink.

3. RAMP
2.0s



Turn the rotary knob to change the Ramp Time for each digit.

4. RAMP
2.0s



Press the rotary knob to select the setting and move to the next digit.

5. LO-L <RAMP> DLAY
2.0s



When done, you will be returned to the previous menu.

GETTING TO KNOW YOUR TESTER

Program a Memory: Change Delay (IR)

1. RAMP <DLAY> CONN
1.0s



Turn the yellow rotary knob to scroll to desired parameter to edit DLAY.

2. DELAY
001.0s

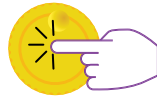

When DLAY is selected. Press the rotary knob to edit the Delay Time. The first digit of Delay Time will blink.

3. DELAY
002.0s



Turn the rotary knob to change the Delay Time for each digit.

4. DELAY
002.0s

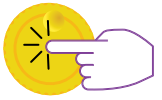

Press the rotary knob to select the setting and move to the next digit.

5. RAMP <DLAY> CONN
2.0s



When done, you will be returned to the previous menu.

Program a Memory: Change Connect (IR)

1. DLAY <CONN> BACK
OFF



Turn the yellow rotary knob to scroll to desired parameter to edit CONN.

2. CONNECT
OFF



When CONN is selected. Press the rotary knob to edit the Connect Setting. The options will blink.

3. CONNECT
ON



Turn the rotary knob to change the Connect setting: ON or OFF.

4. CONNECT
ON

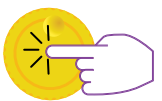

Press the rotary knob to select the setting.

5. DLAY <CONN> BACK
ON



When done, you will be returned to the previous menu.

GETTING TO KNOW YOUR TESTER

Program a Memory: Type GND

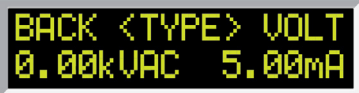
1. 



Turn the yellow rotary knob to scroll to desired parameter to edit, TYPE.

2. 

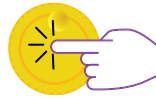

When TYPE is selected. Press the rotary knob to edit the Test Type. The options will blink.

3. 



Turn the rotary knob to change the Test Type: ACW, DCW, IR or GND.

4. 



Press the rotary knob to select the Test Type.

5. 



When done, you will be returned to the previous menu.

GETTING TO KNOW YOUR TESTER

Program a Memory: Change Current (GND)

1. 



Turn the yellow rotary knob to scroll to desired parameter to edit **CURR**.

2. 

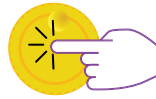

When **CURR** is selected. Press the rotary knob to edit the Current. The first digit of Current will blink.

3. 



Turn the rotary knob to change the Current for each digit.

4. 

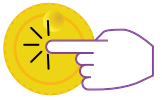

Press the rotary knob to select the setting and move to the next digit.

5. 



When done, you will be returned to the previous menu.

Program a Memory: Change HI-Limit (GND)

1. 



Turn the yellow rotary knob to scroll to desired parameter to edit **HI-L**.

2. 



When **HI-L** is selected. Press the rotary knob to edit the HI-Limit. The first digit of HI-Limit will blink.

3. 



Turn the rotary knob to change the HI-Limit setting for each digit.

4. 

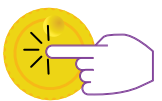

Press the rotary knob to select the setting and move to the next digit.

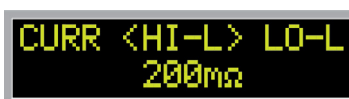
5. 



When done, you will be returned to the previous menu.

GETTING TO KNOW YOUR TESTER

Program a Memory: Change LO-Limit (GND)



Turn the yellow rotary knob to scroll to desired parameter to edit LO-L.

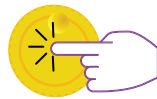

When LO-L is selected. Press the rotary knob to edit the LO-Limit. The first digit of LO-Limit will blink.

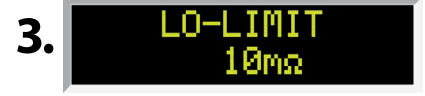

Turn the rotary knob to change the LO-Limit setting for each digit.



Press the knob to select the setting and move to the next digit.



When done, you will be returned to the previous menu.

Program a Memory: Change Dwell (GND)



Turn the yellow rotary knob to scroll to desired parameter to edit DWLL.



When DWLL is selected. Press the rotary knob to edit the Dwell Time. The first digit of Dwell Time will blink.



Turn the rotary knob to change the Ramp Time for each digit.

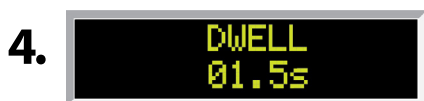

Press the rotary knob to select the setting and move to the next digit.



When done, you will be returned to the previous menu.

GETTING TO KNOW YOUR TESTER

Program a Memory: Change Frequency (GND)

1. DWLL <FREQ> OFFS
60Hz



Turn the yellow rotary knob to scroll to desired parameter to edit FREQ.

2. FREQUENCY
60Hz

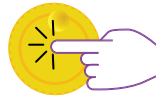

When FREQ is selected. Press the rotary knob to edit the Frequency. The options will blink.

3. FREQUENCY
50Hz



Turn the rotary knob to change the Frequency setting: 50Hz or 60Hz.

4. FREQUENCY
50Hz

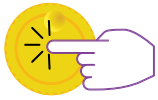

Press the rotary knob to select the setting.

5. DWLL <FREQ> OFFS
50Hz



You will be returned to the previous menu.

Program a Memory: Change Offset (Manual)

1. FREQ <OFFS> CONN
0mΩ



Turn the yellow rotary knob to scroll to desired parameter to edit OFFS.

2. TEST TO AUTO SET
PUSH KNB TO EDIT



When OFFS is selected. Press the rotary knob to edit the Offset.

3. OFFSET
10mΩ



Turn the rotary knob to change the Offset setting.

4. OFFSET
10mΩ



Press the rotary knob to select the setting.

5. FREQ <OFFS> CONN
10mΩ



You will be returned to the previous menu.

GETTING TO KNOW YOUR TESTER

Program a Memory: Change Offset (Auto)



When **OFFS** is selected. Push the rotary knob to edit the Offset. The options will blink.



Short the Red High Current lead with the Black Return Lead as shown above.



Push the green **TEST** button to start reading the offset value. **CAUTION:** The tester will start outputting once the **TEST** button is pressed.



Tester performing Auto Offset.



Push the knob to select the setting.

Program a Memory: Change Connect



Turn the yellow rotary knob to scroll to desired parameter to edit **CONN**.

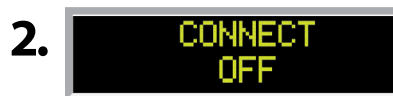

When **CONN** is selected. Press the rotary knob to edit the Connect Setting. The options will blink.



Turn the rotary knob to change the Connect setting: **ON** or **OFF**.



Press the rotary knob to select the setting.

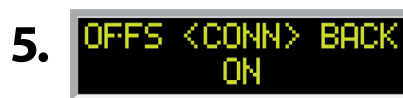

You will be returned to the previous menu.

GETTING TO KNOW YOUR TESTER

Go Back to the Home Screen

1. 

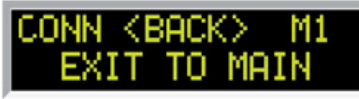

Turn the yellow rotary knob to scroll to **BACK** in order to scroll to the home screen.

2. 

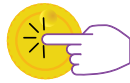

When **BACK** is selected, press the rotary knob. You will be returned to the home screen.

3. 



Home Screen

SYSTEM PARAMETER DESCRIPTIONS

System Parameter	Setting	Description
SCTY (security) ²	OFF	With SCTY set to OFF, all test and system parameters can be edited.
	RUN	With SCTY set to RUN, the user will not be able to recall any of the memory locations or edit any of the test and system parameters. With this setting, if the user attempts to edit any test or system parameter, the following message will be displayed, "Security is RUN, can't be edited."
	MEM	With SCTY set to MEM, the user will be able to recall any of the 20 available memory locations. The user will not be able to edit any test or system parameters.
PLC Remote	ON/OFF	Allows the user to initiate a test through the REMOTE INPUT on the rear panel of the tester. If PLC Remote = ON the front panel TEST button is disabled then a test may only be started through the rear panel I/O. If PLC Remote = OFF, the test must be initiated via the front panel TEST button.
DUAL TEST	ON/OFF	Allows the user to initiate a test through use of Dual Test Switch connected to the Signal Input port of the tester. This functionality requires PLC Remote parameter to be set to ON. If DUAL Test = ON, the front panel TEST button is disabled and a test may only be started by pressing dual test switches within 0.5 seconds of one another. If DUAL Test = OFF, the regular PLC remote operation applies. ¹
SINGLE STEP (SS)	ON/OFF	If Single Step = ON, the instrument will pause after each step is completed, even if Step Connect function is set to ON. To continue the test sequence, press the TEST button to execute the next connected step. Each time the TEST button is pressed the next connected step will execute. If you press the RESET button before completing all connected steps, it will return the instrument to the original starting step. If a step fails and you wish to continue to the next step, do not press the RESET button but press the TEST button.
FAIL STOP (FS)	ON/OFF	If Fail Stop = ON, a sequence of tests will stop if a failure occurs. If Fail Stop = OFF, the sequence of tests will continue to the end of the sequence regardless of whether or not a failure has occurred. If a failure has occurred, the red RESET button will light and alarm will sound indicating failure during the sequence. Pressing the RESET button will silence the alarm and reset the instrument.
GFI	ON/OFF	Since the leakage current measuring circuit of the instrument monitors only current that flows through the return lead, the possibility exists for current to flow directly from the high voltage output to earth ground without being measured. The GFI (Ground Fault Interrupt) circuit monitors the current between the high voltage output and earth ground. Therefore, if you touch the high voltage lead and earth ground, the instrument will detect this hazardous condition and shut off immediately.

If running a sequence of connected tests and all tests pass, the Dual Remote Palm switches will send a RESET signal to the tester at the end of the sequence. If a test in the sequence fails, the Dual Palm Remote switches will not send a RESET signal to the tester. In this case a reset can be performed by either using the front panel RESET button or by pressing the primary switch of the Dual Palm Remote switches. The primary switch of the Dual Remote Palm switches is directly connected to the Signal Input of the tester. If no RESET signal is received by the tester, the next press of the Dual Palm Remote switch would advance and run the next step in the memory.

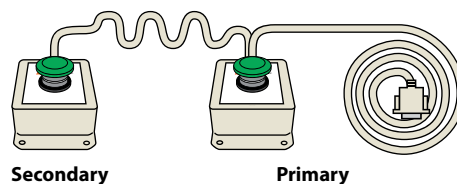

Dual Palm Remote Switches (Sold Separately)

²Anytime the Security setting is changed the user will be asked to enter a PIN number. This PIN will be required again if the Security parameter needs to be set to a different setting. Refer to the Edit Security flow chart for instructions on setting the pin.

SETTING SYSTEM PARAMETERS

Edit Security Settings

1. 



Default screen.

2. 



Turn the yellow rotary knob to scroll to **SCTY** to edit Security settings.

3. 

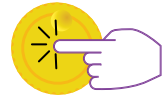

When **SCTY** is selected. Press the rotary knob to enter the Security settings. The options will blink.

4. 



Turn rotary knob to change the Security settings: **OFF**, **RUN** or **MEM**.

5. 



Press the rotary knob to select the Security setting option.

6. 



Enter a PIN number for the Security setting. Turn rotary knob to enter the PIN.

7. 

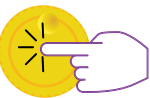

Press the rotary knob to save the PIN. This PIN will be required when the Security setting is edited.

8. 



You will be returned to the previous menu.

SETTING SYSTEM PARAMETERS

Edit PLC Remote Settings

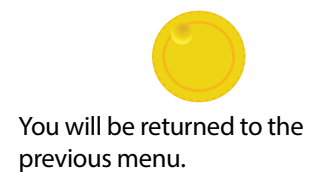
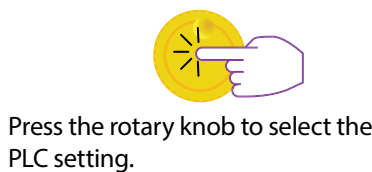
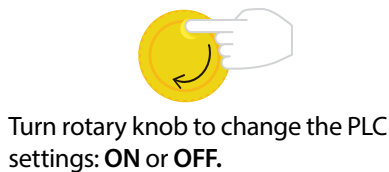
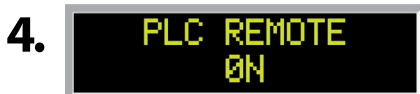
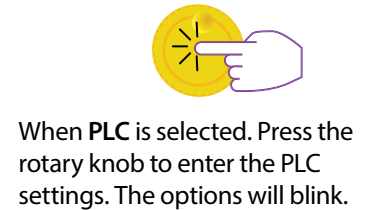
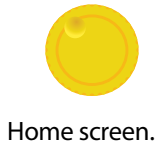

Edit Dual Settings

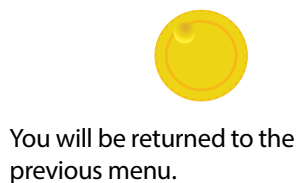
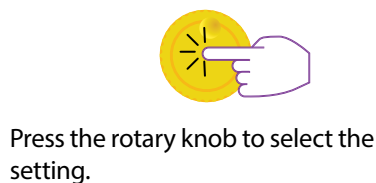
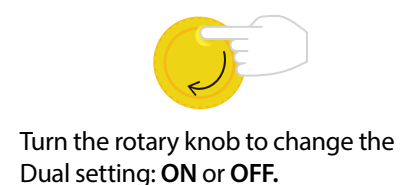
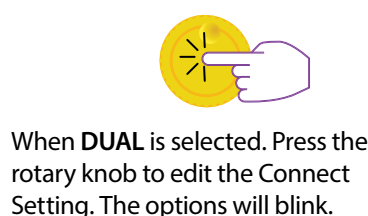
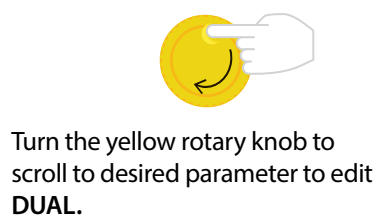

SETTING SYSTEM PARAMETERS

Edit Single Step Settings



Turn the yellow rotary knob to scroll to desired parameter to edit **SINGLE STEP**.

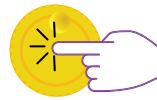

When **SINGLE STEP** is selected, press the rotary knob to edit the Single Step Setting. The options will blink.



Turn the rotary knob to change the Single Step setting: **ON** or **OFF**.



Press the rotary knob to select the setting.



You will be returned to the previous menu.

Edit Fail Stop Settings



Turn the yellow rotary knob to scroll to desired parameter to edit **FAIL STOP**.



When **FAIL STOP** is selected, press the rotary knob to edit the Fail Stop Setting. The options will blink.



Turn the rotary knob to change the Fail Stop setting: **ON** or **OFF**.

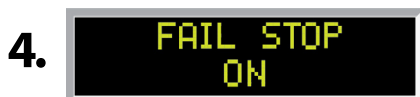

Press the rotary knob to select the setting.



You will be returned to the previous menu.

SETTING SYSTEM PARAMETERS

Edit GFI Settings



Turn the yellow rotary knob to scroll to desired parameter to edit GFI.

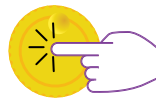

When GFI is selected, press the rotary knob to edit the GFI Setting. The options will blink.



Turn the rotary knob to change the GFI setting: ON or OFF.







Press the rotary knob to select the setting.



You will be returned to the previous menu.

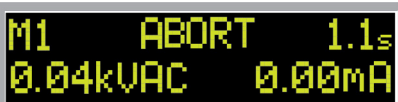

USING THE DISPLAY

Test Mode Display

Test Mode Display	Test Type	Description
	AC/DC Hipot & IR	Displayed when the test voltage is ramping up from 0.0 VAC/VDC to full test voltage.
	AC/DC Hipot & GND	Displayed when the test voltage has reached full potential. Dwell is the amount of time the potential is held at the set value.
	AC/DC Hipot, IR & GND	Displayed when a test sequence has passed. The green TEST button will illuminate and a short audible beep tone will be activated.
	AC/DC Hipot, IR & GND	Displayed if the operator elects to stop a test in process. This can be accomplished by pressing the RESET button during the test.
	IR	Displayed while the test is in process. If the insulation resistance value exceeds the set limits, the test will fail after the DELAY time has expired.

USING THE DISPLAY

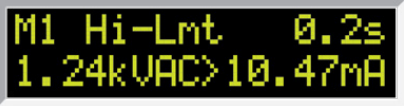
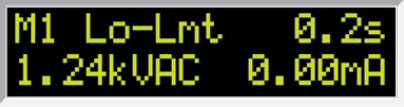

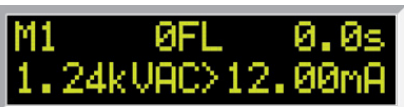
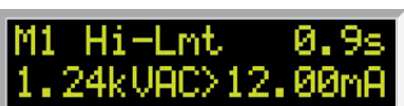
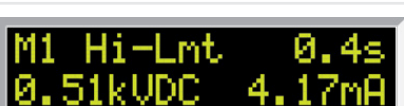
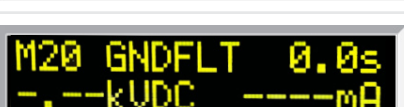
Failure Mode Display

Failure Mode Display*	Test Type	Description
	AC Hipot	Displayed if the leakage current exceeds the high limit setting, but does not exceed the metering range.
	AC Hipot	Displayed if the leakage current does not exceed the low limit setting.
	AC Hipot	Displayed if there is a short circuit in the DUT during the test.
	AC Hipot	Displayed if a flash over occurs in the DUT during the test, which results in an OFL condition due to the current exceeding the maximum metering range.
	AC Hipot	Displayed if the leakage current exceeds the metering range and neither a short circuit nor flash over occurred.
	DC Hipot	Displayed if the leakage current exceeds the high limit setting, but does not exceed the metering range.
	ACW DCW IR	This message appears on the display if the GFI threshold is exceeded during the test.

*For all failures, the red RESET button will illuminate and an alarm will be activated. To stop the alarm, please press the RESET button once. The alarm will stop and the display will retain the failure information. The tester is now ready for the next test. If the RESET button is pressed again, the failure information will be cleared and the display will indicate the setting data of the executed test.

USING THE DISPLAY

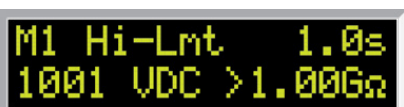
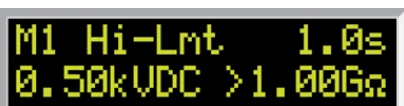
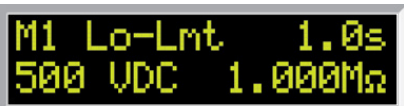

Failure Mode Display

Failure Mode Display*	Test Type	Description
	DC Hipot	Displayed if the leakage current does not exceed the low limit setting.
	DC Hipot	Displayed if there is a short circuit in the DUT during the test.
	DC Hipot	Displayed if a flash over occurs in the DUT during the test, which results in an OFL condition due to the current exceeding the maximum metering range.
	IR	Displayed if the insulation resistance exceeds the high limit setting, but does not exceed the metering range.
	IR	Displayed if the insulation resistance exceeds the high limit setting, and exceeds the metering range.
	IR	Displayed if the leakage current does not exceed the low limit setting and is within the metering range.

*For all failures, the red RESET button will illuminate and an alarm will be activated. To stop the alarm, please press the RESET button once. The alarm will stop and the display will retain the failure information. The tester is now ready for the next test. If the RESET button is pressed again, the failure information will be cleared and the display will indicate the setting data of the executed test.

USING THE DISPLAY

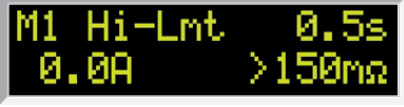
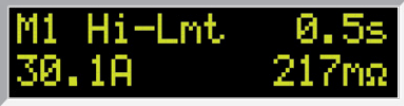
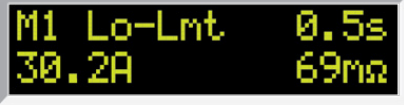

Failure Mode Display

Failure Mode Display**	Test Type	Description
	GB	Displayed if the resistance exceeds the metering range. For current range 3.0 – 10.0A
	GB	Displayed if the resistance exceeds the metering range. For current range 10.1 – 30.0A
	GB	Displayed if the resistance exceeds the metering range. For current range 30.1 – 40.0A
	GB	Displayed if the resistance exceeds the high limit trip setting, but does not exceed the metering range.
	GB	Displayed if the resistance does not exceed the low limit setting.

** For all failures, the red RESET button will illuminate and an alarm will be activated. To stop the alarm, please press the RESET button once. The alarm will stop and the display will retain the failure information. The tester is now ready for the next test. If the RESET button is pressed again, the failure information will be cleared and the display will indicate the setting data of the executed test.

USING THE DISPLAY

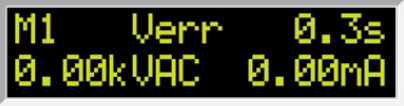
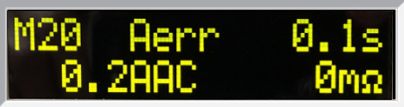
Error Messages

Display	Description
	This message appears on the display if the tester's output reading does not match the setting. When the tester has an output problem and the TEST button is pressed, the Output Error screen will appear. The failure light will illuminate and an alarm will be heard.
	Pressing the RESET key will allow you to return to the test mode. The failure light and alarm can be cleared by pressing the RESET button. If Output Error occurs please call SCI Customer Support Center at 1-800-504-0055 for assistance.
	<p>All of the buttons and keys are not active in this situation. This type of failure permanently locks the tester in the Fatal Error mode and requires that the tester be serviced by an SCI authorized service center. Contact SCI Customer Support Center at 1-800-504-0055 to receive further instruction.</p> <p>FATAL ERROR 9002 will appear on the display if the tester's System data or the Model/Option data are corrupted and do not match the setting.</p> <p>FATAL ERROR 9003 will appear on the display, if the tester's Calibration data is corrupted.</p>
	This message appears on the screen if the tester detects an over-temperature condition on the power amplifier. The fail light will illuminate and the alarm will be heard. The Reset key can be used to clear this failure condition.

REVIEWING TEST RESULTS FOR MULTISTEP SEQUENCES

After the test is performed, the test results will be indicated on the front panel display.

Pass: If the DUT passes the test, you will hear a short audible beep and the display will indicate the test result.

Fail: If a failure occurs, you will hear a long audible alarm and the red flashing indicator will light up. To stop the alarm, press the RESET button.

The test results from the memories that are executed can be reviewed by turning the rotary knob left or right. Successive rotation of the knob will continue advancing to the next result. The results of the last step in the process will be followed by the first step when scrolling through the results. Results can be reviewed at any time before the next test is executed. All results are cleared at the start of the next test cycle.

USING THE REMOTE I/O

Two 9-pin "D" type connectors are mounted on the rear panel that provides REMOTE-INPUT-OUTPUT control and information.

- These connectors mate with standard 9 pin D-sub-miniature connector provided by the user.
- The output mates to a male (plug) connector while the input mates to a female (receptacle) connector.
- For best performance, a shielded cable should be used. To avoid ground loops, the shield should not be grounded at both ends of the cable.

Suggested AMP part numbers for interconnecting to the Remote I/O

Part Number	Description
205204-4	Plug Shell with Ground Indents
205203-3	Receptacle Shell
745254-7	Crimp Snap-In Pin Contact (for Plug)
745253-7	Crimp Snap-In Socket Contact (for Receptacle)
745171-1	Shielded Cable Clamp (for either Plug or Receptacle)
747784-3	Jackscrew Set (2)

REMOTE I/O Pinouts

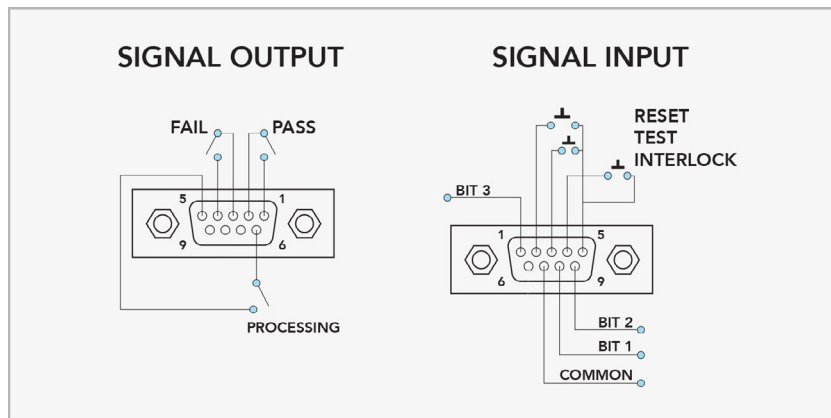

USING THE REMOTE I/O

Signals on Remote I/O

REMOTE INPUT/OUTPUT

Remote Output

Output Signal	Pins	Description
PASS	1 and 2	The relay contact closes after detecting that the device under test passed all tests. The connection is opened when the next test is initiated or the reset function is activated.
FAIL	3 and 4	The relay contact closes after detecting that the device under test failed any test. The connection is opened when the next test is initiated or the reset function is activated.
PROCESSING	5 and 6	The relay contact closes while the tester is performing a test. The connection is opened at the end of the test.

These are normally open free contacts and will not provide any voltage or current. The ratings of the contacts are 1 AAC/250 VAC (0.5 ADC). When a terminal becomes active, the relay closes thereby allowing the external voltage to operate an external device.

Remote Input

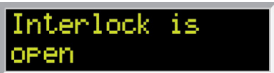
Output Signal	Pins	Description
TEST	3 and 5	A normally open momentary switch can be wired across pins 3 and 5 to allow remote operation of the TEST function.
REST	2 and 5	A normally open momentary switch can be wired across pins 2 and 5 to allow remote operation of the RESET function. For safety, the front panel RESET button remains active even when a remote reset switch is connected so that high voltage can be shut down from either location.
INTERLOCK	4 and 5	<p>Remote Interlock utilizes a set of closed contacts to enable the tester's output. The output of the tester will be disabled under the following conditions:</p> <ul style="list-style-type: none">• If the Interlock contacts are open and the TEST button is pushed• If the interlock contacts are opened during a test (test will automatically abort) <p>A pop-up message will be displayed on the screen: </p> <p>The tester can still be used without the external interlock device as long as the Interlock Connector (P/N # 99-10040-01 provided with unit) is plugged into the Remote Interface, Signal Input port. If there is nothing connected to the Remote Interface, Signal Input port to provide a connection to the interlock, the tester will not perform tests.</p>

When the PLC Remote mode is ON, the tester will respond to simple switch or relay contacts closures. When the PLC Remote function is ON the TEST button on the front panel will be disabled.

USING THE REMOTE I/O

Remote Memory Bit Selection

Remote Signal Inputs and Memory Access

- The Remote Memory Select function gives you the capability to quickly select and initiate a test remotely.
- You can access first six (6) pre-programmed memories by connecting pins 1, 8 and 9 to the common pin 7, in different combinations.
- The memory select bits should be set simultaneously and remain set for a minimum of 20ms to guarantee that the correct memory will be selected.
- The memory select bits may be set in sequential manner, provided that the time delay between each bit is less than 4ms.
- When the desired bit pattern has been established it should remain set for a minimum of 20ms to guarantee that the correct memory will be selected.
- It may be necessary to “OR” the momentary switches (relay contacts) to prevent incorrect program selection due to timing errors.

REMOTE FILE SELECT TRUTH TABLE			
BIT 3	BIT 2	BIT 1	MEM #
0	0	1	01
0	1	0	02
0	1	1	03
1	0	0	04
1	0	1	05
1	1	0	06

WARNING

ACTIVATING TEST PROGRAM FUNCTIONS THROUGH THE REMOTE CONNECTOR SELECTS THE MEMORY AND STARTS THE TEST THAT IS PRE-PROGRAMMED INTO THAT MEMORY.

CAUTION

Do not connect voltage or current to the signal inputs. Applying voltage to the signal input could result in damage to the control circuitry.

USING THE TESTER ACCESSORIES

WARNING

NEVER CONNECT THE ADAPTER BOX OR TEST LEADS TO THE TESTER WHILE THE HIGH VOLTAGE OUTPUTS ARE ENERGIZED.

Using the Test Leads

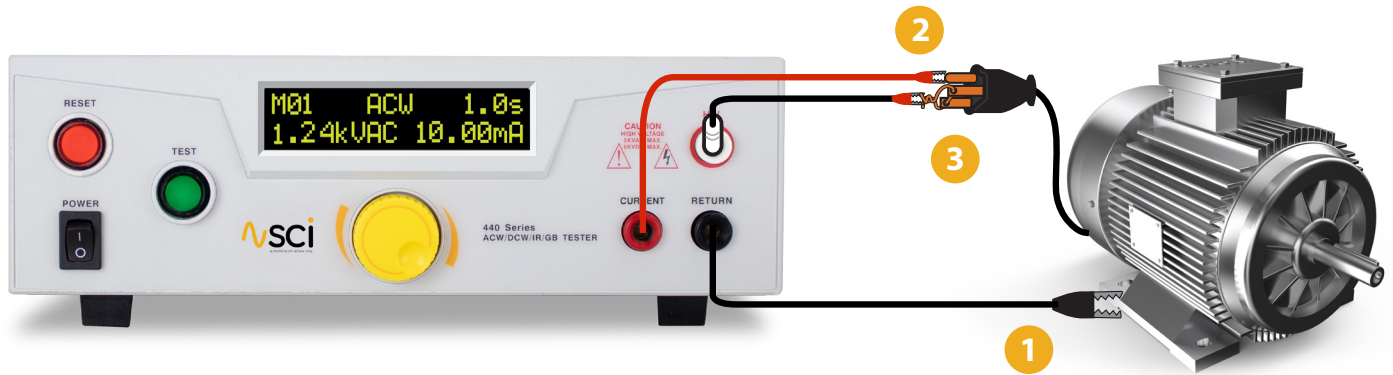

- 1 Connect the black return lead (99-10865-01) to the front panel return output terminal and connect the other end of the lead to the dead metal on the chassis of the DUT.
- 2 If you are performing a Ground Bond test, connect one end of the high current lead (99-10866-01) to the front panel current output terminal and the other end to the ground pin of the DUT line cord.
- 3 If you are using the high voltage lead (102-055-913, w/ red clip) or probe, connect it to the front panel high voltage terminal and connect the other end of the cable to both the hot and neutral pins of the line cord.

APPENDIX A: INSTALLATION AND TEST OPERATOR INFORMATION

Installation

1. Unpacking and Inspection

Your tester was shipped in a custom foam insulated container that complies with ASTM D4169-92a Assurance Level II Distribution Cycle 13 Performance Test Sequence.

If the shipping carton is damaged, inspect the contents for visible damage such as dents, scratches, or broken meters. If the tester is damaged, notify the carrier and SCL customer support department immediately. Please save the shipping carton and packing material for the carrier's inspection. Our customer support department will assist you in the repair or replacement of your tester. Please do not return your product without first notifying us and receiving an RMA (return materials authorization) number.

2. Safe Lifting and Carrying Instructions

Proper methods of lifting and carrying can help to protect against injury. Follow the recommendations below to ensure that testers are handled in a safe manner.

- Determine if the tester can be lifted by one individual or requires additional support.
- Make sure that your balance is centered and your feet are properly spaced, shoulder width apart behind the tester.
- Bend at the knees and make sure your back is straight.
- Grip the tester with your fingers and palms, and do not lift unless your back is straight.
- Lift up with your legs, not your back.
- Keep the tester close to your body while carrying.
- Lower the tester by bending your knees. Keep your back straight.

3. Contents of the Carton

Inside the carton will be the following:

DESCRIPTION	SLA PART NUMBER
440 Series Tester	440 Series Hipot, Ground Bond, IR Tester
High Voltage Cable	102-055-913
Ground Bond Return Lead	99-10865-01
Ground Bond Test Lead	99-10866-01
Fuse	99-10783-01 (446) 99-10168-01 (448)
Interlock Connector	99-10040-01
Line Cord*	125-013-001 10A (446) 99-10164-01 15A (448)
USB Cable	99-10797-01

*The Line Cord listed is American. Other combinations of the Line Cord are available upon request.

WARNING

ONLY ACCESSORIES WHICH MEET THE MANUFACTURER'S SPECIFICATION SHALL BE USED.

INSTALLATION AND TEST OPERATOR INFORMATION

Installation

4. Preparation for Use

Power Requirements and Line Voltage Selection

CAUTION

This tester requires a power source of either 115 volts AC $\pm 10\%$, 47-63 Hz single phase or 230 volts AC $\pm 10\%$, 47-63 Hz single phase. In addition, please be sure the correct fuse is selected and installed while the tester is in the off position.

5. Power Cable

WARNING

BEFORE CONNECTING POWER TO THIS TESTER, THE PROTECTIVE GROUND (EARTH) TERMINALS OF THIS TESTER MUST BE CONNECTED TO THE PROTECTIVE CONDUCTOR OF THE LINE (MAINS) POWER CORD. THE MAIN PLUG SHALL ONLY BE INSERTED IN A SOCKET OUTLET (RECEPTACLE) PROVIDED WITH A PROTECTIVE GROUND (EARTH) CONTACT. THIS PROTECTIVE GROUND (EARTH) MUST NOT BE DEFEATED BY THE USE OF AN EXTENSION CORD (POWER CABLE) WITHOUT A PROTECTIVE CONDUCTOR (GROUNDING).

This tester is shipped with a three-wire power cable. When this cable is connected to an appropriate AC power source, this cable connects the chassis to earth ground. The type of power cable shipped with each tester depends on the country of destination.

Operating Environment

This equipment is intended for indoor use only. The equipment has been evaluated according to Installation Category II and Pollution Degree 2 as specified in IEC 664.

This tester may be operated within the following environmental conditions:

Temperature32° - 104° F (0° - 40° C)

Relative humidity 20 - 80%

WARNING

DO NOT BLOCK ANY VENTILATION OPENINGS TO PREVENT OVER HEATING OF THE EQUIPMENT. KEEP THE VENTILATION SLITS UNCOVERED DURING OPERATION. FAILURE TO DO SO COULD CAUSE THE TESTER TO OVERHEAT AND MAY DAMAGE INTERNAL COMPONENTS.

If the tester is used in a matter not specified by the manufacturer, the protection provided by the tester may be impaired.

INSTALLATION AND TEST OPERATOR INFORMATION

Storage and Shipment

This tester may be stored or shipped in environments with the following limits:

Temperature -40° - 167° F (-40° - 75°C)
Altitude..... 50,000 feet (15,240 meters)

The tester should also be protected against temperature extremes which may cause condensation within the tester.

Packaging

Contact our customer support department (1-847-932-3662) for an RMA (return materials authorization) number. Please enclose the tester with all options, accessories, and test leads. Indicate the nature of the problem or type of service needed. Also, please mark the container "FRAGILE" to insure proper handling. Please refer to the RMA number for all correspondence.

Packaging Instructions:

1. Be sure to REMOVE ALL ACCESSORIES and the INTERLOCK DISABLE from the tester.
2. Wrap the tester in a bubble pack or similar foam. Enclose the same information as above.
3. Use a strong double-wall container that is made for shipping instrumentation. 350 lb. test material is adequate.
4. Use a layer of shock-absorbing material 70 to 100 mm (3 to 4 inch) thick around all sides of the tester. Protect the control panel with cardboard.
5. Seal the container securely.
6. Mark the container "FRAGILE" to insure proper handling.
7. Please ship models via Federal Express or UPS air.
8. Please refer in all correspondence to your RMA number.

TEST OPERATOR SAFETY CONSIDERATIONS

1. Qualifications

This tester generates voltages and currents which can cause **harmful or fatal electric shock** and must only be operated by a skilled worker trained in its use.

The operator should understand the electrical fundamentals of voltage, current, and resistance.

2. Safety Procedures

Operators should be thoroughly trained to follow these and all other applicable safety rules and procedures before they begin a test. Defeating any safety system should be treated as a serious offense and should result in severe penalties, such as removal from the Hipot testing job. Allowing unauthorized personnel in the area during a test should also be dealt with as a serious offense.

3. Dress

Operators should not wear jewelry which could accidentally complete a circuit.

4. Medical Restrictions

This tester should not be operated by personnel with heart ailments or devices such as pacemakers.

5. Test Procedures

WARNING NEVER PERFORM A HIPOT TEST ON ENERGIZED CIRCUITRY OR EQUIPMENT!

If the tester has an external safety-ground connection, be sure that this is connected. Then connect the return lead **first** for any test regardless of whether the device under test is a sample of insulating material tested with electrodes, a component tested with the high voltage test lead, or a cord-connected device with a two or three-prong plug.

Plug in the high voltage test lead only when it is being used. Handle its clip only by the insulator---**never touch the clip directly**. Be certain that the operator has control over any remote test switches connected to the Hipot. Double-check the return and high voltage connections to be certain that they are proper and secure.

WARNING NEVER TOUCH THE ITEM UNDER TEST OR ANYTHING CONNECTED TO IT WHILE HIGH VOLTAGE IS PRESENT DURING THE HIPOT TEST.

When testing with DC, always discharge the capacitance of the item under test and anything the high voltage may have contacted--such as test fixtures--before handling it or disconnecting the test leads.

Hot stick probes can be used to discharge any capacitance in the item under test as a further safety precaution. A hot stick is a non-conducting rod about two feet long with a metal probe at the end which is connected to a wire. To discharge the device under test, two hot sticks are required. First connect both probe wires to a good earth ground. Then touch one probe tip to the same place the return lead was connected. While holding the first probe in place, touch the second probe tip to the same place where the high voltage lead was connected.

TEST OPERATOR SAFETY CONSIDERATIONS

6. Test Station

Location

Select an area away from the main stream of activity which employees do not walk through in performing their normal duties. If this is not practical because of production line flow, then the area should be roped off and marked for **HIGH VOLTAGE TESTING**. No employees other than the test operators should be allowed inside. If benches are placed back-to-back, be especially careful about the use of the bench opposite the test station. Signs should be posted: **"DANGER - HIGH VOLTAGE TEST IN PROGRESS - UNAUTHORIZED PERSONNEL KEEP AWAY"**.

Power

Voltage-Hipot Test Equipment must be connected to a good ground. Be certain that the power wiring to the test bench is properly polarized and that the proper low resistance bonding to ground is in place.

Power to the test station should be arranged so that it can be shut off by one prominently marked switch located at the entrance to the test area. In the event of an emergency, anyone can cut off the power before entering the test area to offer assistance.

WARNING

THE MAINS PLUG IS USED AS THE DISCONNECTING DEVICE AND SHALL REMAIN READILY OPERABLE. THE SOCKET-OUTLET SHALL BE INSTALLED NEAR THE EQUIPMENT AND SHALL BE EASILY ACCESSIBLE.

CAUTION

Do not replace the power supply cord with an improperly rated cord. For North American: A UL listed and CSA labeled power cord must be used with the tester in the United States and Canada. The power cord must include a NEMA5-15 style male plug, SVT or SJT cord sets, and be rated for at least 125VAC, 10A, number 16 gauge (or 125VAC, 15A, number 14 gauge) wire or larger, and the length of the cord does not exceed 2 m must be used. For European: A certified power supply cord not lighter than light PVC sheathed flexible cord according to IEC 60227, designation H03 VV-F or H03 VVH2-F (for equipment mass not exceeding 3 kg), or H05 VV-F or H05 VVH2-F2 (for equipment mass exceeding 3 kg), and be rated for at least 3G 0.75 mm² (for rated current up to 10 A) or 3G 1.0mm² (for rated current over 10 A up to 16 A) wire or larger, and the length of the cord does not exceed 2 m must be used.

Work Area

Perform the tests on a non-conducting table or workbench, if possible. There should not be any metal in the work area between the operator and the location where products being tested will be positioned.

Position the tester so the operator does not have to reach over the product under test to activate or adjust the tester. If the product or component being tested is small, it may be possible to construct guards or an enclosure, made of a non-conducting material such as clear acrylic, such that the item being tested is within the guards or enclosure during the test, and fit them with switches so that the tester will not operate unless the guards are in place or the enclosure closed. The outlet which is used to provide power to the tester should be easily accessible.

Keep the area clean and uncluttered. All test equipment and test leads not absolutely necessary for the test should be removed from the test bench and put away. It should be clear to both the operator and to any observers which product is being tested, and which ones are waiting to be tested or have already been tested. If the tester is used in a manner not specified by SCI the protection provided by the tester may be impaired.

Do not perform Hipot tests in a combustible atmosphere or in any area where combustible materials are present.

KEY SAFETY POINTS TO REMEMBER

- Keep unqualified and unauthorized personnel away from the test area.
- Arrange the test station in a safe and orderly manner.
- Never touch the product or connections during a test.
- In case of any problem, turn off the high voltage first.
- Properly discharge any item tested with DC before touching connections.

APPENDIX B - 440 SERIES TESTER SPECIFICATIONS

Unless otherwise stated, accuracies are relative to a laboratory standard measurement.

Why use the term "Counts"?

SCI publishes some specifications using COUNTS which allows us to provide a better indication of the tester's capabilities across measurement ranges. A COUNT refers to the lowest resolution of the display for a given measurement range. For example, if the resolution for voltage is 1V then 2 counts = 2V.

440 Functional Specifications

INPUT (446 and 448)		
Voltage	100 - 120Vac / 200 - 240Vac ±10% Auto Range	
Frequency	50/60Hz ± 5%	
Fuse	446	10A / 250Vac Slow-Blow
	448	15A / 250Vac Fast-Blow

DIELECTRIC WITHSTAND TEST MODE		
Output Rating	446	5 KV @ 20 mA AC 6 KV @ 5 mA DC
	448	5 KV @ 99.99 mA AC 6 KV @ 10 mA DC
Voltage Setting/Display	Range	0 - 5.00 KV AC 0 - 6.00 KV DC
	Resolution	0.01
	Accuracy	± (2% of setting + 5V)
Current Display	446	Range: 0 - 20.00 mA AC, 0 - 5.00 mA DC Resolution: 0.01 mA Accuracy: ± (2% of reading + 0.02 mA)
	448	Range: 0 - 99.99 mA AC, 0 - 10.00 mA DC Resolution: 0.01 mA Accuracy: ± (2% of reading + 0.06 mA)
Hi-Limit Lo-Limit	446 AC	Range: Lo-Limit 0 - 20.00 mA, Hi-Limit 0.10 - 20.00 mA Resolution: 0.01 mA Accuracy: ± (2% of setting + 2 counts)
	446 DC	Range: Lo-Limit 0 - 5.00 mA, Hi-Limit 0.02 - 5.00 mA Resolution: 0.01 mA Accuracy: ± (2% of setting + 2 counts)
	448 AC	Range: Lo-limit 0 - 99.99 mA, Hi-Limit 0.10 - 99.99 mA Resolution: 0.01 mA Accuracy: ± (2% of reading + 6 counts)
	448 DC	Range: Lo-Limit 0 - 10.00 mA, Hi-Limit 0.02 - 10.00mA Resolution: 0.01 mA Accuracy: ± (2% of reading + 6 counts)
Failure Detector	Audible and Visual	
DC Output Ripple	446	<5 % (6KV / 5mA at Resistive Load)
	448	<5 % (6KV / 10mA at Resistive Load)

DIELECTRIC WITHSTAND TEST MODE (Cont.)		
Discharge Time	446	< 50 ms for no load, < 200 ms for capacitor load
	448	< 50 ms for no load, < 100 ms for capacitor load
Max. Capacitive Load in DC Mode	1µF < 1KV 0.75µF < 2KV 0.5µF < 3KV	0.08µF < 4KV 0.04µF < 5KV 0.015µF < 6KV
AC Wave Form	Sine Wave, Crest Factor = 1.3 - 1.5 and output voltage > 300V	
AC Output Frequency	50Hz/60Hz ± 0.1%, User Selection	
Output Regulation	± (1% of output + 5V), From no load to full load	
Dwell Timer	Range:	0, 0.2 - 60.0 (0=continuous)
	Resolution:	0.1
	Accuracy:	± (0.1% of setting + 0.05 sec)
Ramp Timer	Range:	0.2-180.0
	Resolution:	0.1
	Accuracy:	± (0.1% of setting + 0.05 sec)

INSULATION RESISTANCE TEST MODE		
Output Voltage, VDC	Range: Resolution: Accuracy:	100 - 1000 1 ± (2% of setting + 5V)
Hi-Limit resistance, MΩ	Range: Resolution: Accuracy:	0, 1 - 1000 (0 = OFF) 1 100-499V ± (7% of setting + 2 counts)
Lo-Limit resistance, MΩ	Range: Resolution: Accuracy:	1 - 1000 1 500-1000V ± (3% of setting + 2 counts)
Ramp Time, second	Range: Resolution: Accuracy:	0.1 or 2.0 0.1 ± (0.1% of setting + 0.05 sec)
Delay Time, second	Range: Resolution: Accuracy:	0, 0.5 - 999.9 (0=continuous) 0.1 ± (0.1% of setting + 0.05 sec)

Specifications subject to change without notice.

440 SERIES TESTER SPECIFICATIONS

440 Functional Specifications

GROUND BOND		
Output AC Current, A	Range: Resolution: Accuracy:	1.0 – 40.0 0.1 ± (2 % of setting + 2 counts)
Output AC Voltage, V	8V(Fixed)	
Output Frequency, Hz	50Hz/60Hz ± 0.1%, User Selectable	
Maximum Loading	1.0–10.0A/0–600mΩ, 10.1–30.0A/0–200mΩ, 30.1–40.0A/0–150mΩ	
Offset, mΩ	Range: Resolution: Accuracy:	0-100 1 ± (2 % of setting + 2 counts)
HI and LO-Limit Resistance, mΩ	Range: Resolution: Accuracy:	0 – 150 (30.1-40.0A) 1 ± (2 % of setting + 2 counts)
	Range: Resolution: Accuracy:	0 – 200 (10.1-30.0A) 1 ± (2 % of setting + 2 counts)
	Range: Resolution: Accuracy:	0 – 600 (1.0-10.0A) 1 ± (2 % of setting + 2 counts)
Fix Ramp Timer, second	Range: Resolution: Accuracy	0.4 0.1 ± 0.05 sec
	0-250mOhm à 0.1sec ramp up 251-300mOhm à 0.2sec ramp up 301-450mOhm à 0.3sec ramp up >450mOhm = 0.4sec	
Dwell Timer, second	Range: Resolution: Accuracy	0, 0.1 - 240.0 (0 = continuous) 0.1 ± 0.05 sec

GENERAL SPECIFICATIONS	
PLC Remote Control	Input: Test, Reset, Interlock, Recall Memory 1 - 6 Output: Pass, Fail, Test-in-Process
Safety Agency Listing	CE, cTUVus, RoHS2
Memory	20 Memories All memories are linkable
Security	Run Only Mode (RUN) - To avoid unauthorized access to test parameters and memory locations. Memory Mode (MEM)- Allows access to memory locations but restricts any changes in test parameters. Off – Full function
Meter Max	When a fault condition occurs during the test, the voltage meter will be shown the values of a 0.1 seconds before.
Line Cord	Detachable 6 ft (1.8 m) power cable terminated in a three-prong grounding plug.
Terminations	6 ft (1.8 m) high voltage and return leads (2) with clips. An optional remote receptacle box may be purchased for testing items terminated with a line cord. International receptacles are also available.
Mechanical 446	Tilt up front feet. Dimensions: 280mm(W) × 89mm(H) × 400 mm(D) Weight: 8 Kg
Mechanical 448	Tilt up front feet. Dimensions: 430mm(W) × 132mm(H) × 400 mm(D) Weight: 24 Kg
Environmental	Operating Temperature: 32° - 104°F (0° - 40°C) Relative Humidity: 20 to 80%
Calibration	Traceable to National Institute of Standards and Technology (NIST). Calibration controlled by software. Adjustments are made through front panel keypad in a restricted access calibration mode. Calibration information stored in non-volatile memory.

Specifications subject to change without notice.

APPENDIX C - 440 SERIES OPTIONS

Introduction

This section contains a list and descriptions of available factory installed options at the time of this printing. The list of options contains an option code number which can be referenced on the model option label on the rear panel of the unit when options are present.

Model Option Label

On the rear panel of the tester, you will find a label that contains the option code.

Fore example, your options code may appear as follows:

If fitted with option 1:

OPT: 01

If fitted with options 01 and 02:

OPT: 0102

440 Options List

Code	Description
01	Rear Output
03	Activate USB Port

Option 01 – Rear Output

This option provides three output connections on the rear panel of the tester. These are the same as the front panel HV, RETURN and Ground Bond connections.



- 1 Connector used to attach the high current output lead, adapter box high current lead, or test fixture high current lead to the instrument. This connection provides the output current for the ground bond.
- 2 Return jack for the connection of the black return test lead or three-prong receptacle adapter box. This jack is always active when performing a test.
- 3 High Voltage jack for the connection of the red high voltage test lead or three-prong receptacle adapter box. The jack is recessed for safety when this lead is not being used. This jack is always active when performing a Hipot Test.

Option 03 – USB Interface

This option may be added as a serial type communication protocol. This option provides all of the function control of the USB interface. The Type B USB connector labeled "USB" is for connection of the SCI 440 Series Testers to any compatible PC. When selecting USB Interface, the protocol for interfacing and communicating with a PC can be found in Appendix D: Remote Bus Interface: USB of this manual.

APPENDIX D - REMOTE BUS INTERFACE: USB

This section provides information on the proper use and configuration of bus remote interface. The USB remote interface is optional on all 440 Series models. Please see the OPTIONS section of the manual for details.

USB Interface

This interface provides all of the control commands and parameter setting commands. All commands can be found in the command list of this manual. The USB interface card requires you to download a driver in order for the instrument to recognize the USB interface. The driver can be found on the SCI website:

www.hipot.com/products.html?series=52

Click on “USB Driver” to download the driver. This link contains an automatic extract and install program. Follow the instructions of the installation program to initialize the driver install. NOTE: The USB port acts as a USB to RS-232 converter. As a result, the PC will recognize the USB port as a virtual COM port.

The COM port should have the following configuration. 115200 baud rate, 8 data bits, 1 stop bit, no parity. This interface does not support XON/XOFF protocol or any hardware handshaking.

When sending command over the USB bus, the tester will send a response string of 06 hex or 6 decimal, the Acknowledge (ACK) ASCII control code if the transfer was recognized and completed by the tester. If there is an error with the command string that is sent, the tester will respond with 15 hex or 21 decimal, the Not Acknowledge (NAK) ASCII control code. The ACK or NAK response allows for software handshaking, to monitor and control data flow. When requesting data from the tester, it will automatically send the data back to the controller input buffer. The controller input buffer will accumulate data being sent from the tester including the ACK and NAK response strings, until it has been read by the controller.

USB Interface Command List

The USB bus will automatically send any response back to the controller’s input buffer. Note that the commands are case sensitive and must be typed in capital letters. Each command string should be terminated by the ASCII control code, New Line <NL>, or OAh.

The following conventions are used to describe the commands syntax for the 440 Series testers. Braces ({ }) enclose each parameter for a command string. Triangle brackets (< >) indicate that you must substitute a value for the enclosed parameter. The Pipe (|) is used to separate different parameter options for a command. The command and the parameter data must be separated with a space. All commands that end with a question mark (?) are query commands and require an IEEE-488 read command to retrieve the data from the device’s output buffer.

Test Execution Commands

The following commands are used to control actual output voltage and current from the tester. Please observe all safety precautions.

Command	Description
TEST	Execute a Test
RESET	Abort a Test in Process or Reset Failures
SAO	Set Auto Offset

REMOTE BUS INTERFACE: USB

TEST - Starts the test sequence at the selected step loaded into memory (RAM).

RESET - Stop or abort a test. Also used to reset a latched failure condition.

SAO - Set the offset for the Ground bond test. The cables and any test fixture should be connected before executing the command. This command will perform an actual test and all safety precautions should be observed when using this command.

Memory Location Edits and Companion Queries

The following commands are used to create or modify Test Setup at each Memory Locations.

Command	Description	Value
FL <memory location number> example: FL 01	Load Test Located at Memory Location	Memory location number = 1-20
FL?	Query Memory Location	1-20
SAA	Add ACW Test	
SAD	Add DCW Test	
SAI	Add IR Test	
SAG	Add Default GB Test	
ADD <ACW,p,p,p,p,p,p,p,p,p>	Add all parameters for ACW Test	ACW, Voltage(kV), HI-Limit(mA), LO-Limit(mA), Ramp(s), Dwell(s), Frequency, Connect(ON/OFF)
ADD <DCW,p,p,p,p,p,p,p,p,p>	Add all parameters for DCW Test	DCW, Voltage(kV), HI-Limit(mA), LO-Limit(mA), Ramp(s), Dwell(s), Connect(ON/OFF)
ADD <IR,p,p,p,p,p,p>	Add all parameters for IR Test	IR, Voltage(V), HI-Limit(Ω), LO-Limit(Ω), Ramp(s), Delay(s), Connect (ON/OFF)
ADD <GND,p,p,p,p,p,p,p>	Add all parameters for GND Test	<GND,Current,Hi-Limit,Lo-Limit,Dwell,Frequency,Offset, Connect(ON/OFF)>

REMOTE BUS INTERFACE: USB

FL <memory location number> - Load a memory location from non-volatile memory into random access memory RAM.

The parameter values should use complete text and not use the coded values that are associated with the individual parameter setting commands. Such as "ON" and "OFF" and any toggle field that use words or phrases like "OPEN", "CLOSE". The LS? companion command will also list all parameters in complete text as they appear on the setting screen.

FL? - Query the memory location of the current selection.

ADD command needs test type and parameters listed below:

	ACW	DCW	IR	GND
1	Voltage	Voltage	Voltage	Current
2	HI-Limit	HI-Limit	HI-Limit	HI-Limit
3	LO-Limit	LO-Limit	LO-Limit	LO-Limit
4	Ramp Up	Ramp Up	Ramp Up	Dwell
5	Dwell	Dwell	Delay	Offset
6	Frequency	Connect (ON/OFF)	Connect (ON/OFF)	Frequency
7	Connect (ON/OFF)			Connect (ON/OFF)

REMOTE BUS INTERFACE: USB

Test Parameter Editing Commands

These commands are used to modify the test parameter within each step. These commands require a parameter value to be included with the command. The companion query command will read the parameter. The writing of the parameter requires that the unit not be included with the value, only the numeric value should be included with the command. Also when the query commands are used the response will not include the units characters. Many of the commands will function the same way for multiple test types however the input range may be different and therefore used a different possible set of values.

COMMAND	NAME	TEST TYPES	VALUE
ECC {1 0} ECC?	Edit Memory Connect	ALL	1= On, 0=Off
EC < value > EC?	Edit Current	GND	1.00 - 40.00A
EDE < value > EDE?	Edit Delay	IR	0.0, 0.5 - 999.9s 0.0 = Continuous
EDW < value > EDW?	Edit Dwell	ACW DCW GND	0.0, 0.2 – 60.0s 0.0, 0.2 – 60.0s 0.0, 0.1 – 240.0s 0.0 = Continuous
EF {1 0} EF?	Edit Frequency	ACW GND	1=60Hz, 0=50Hz
EH < value > EH?	Edit HI-Limit	ACW DCW IR GND	.10-20.0mAAC 448: .10-99.99mAAC .02-5.0mADC 448: .02-10.0mADC 1-1000MΩ 0-600mΩ
EL < value > EL?	Edit LO-Limit	ACW DCW IR GND	0.0 – 20.0mA 0.0 – 5.0mA 0 - 1000MΩ 0 - 600mΩ
EO < value > EO?	Edit Offset	GND	0 - 100mΩ
ERU < value> ERU?	Edit Ramp-Up	ACW/DCW IR	0.2-180.0s .1 or 2.0s
EV <value> EV?	Edit Voltage	ACW DCW IR	0.00 – 5kV 0.00 – 6kV 100 - 1000V

REMOTE BUS INTERFACE: USB

System Parameter Editing Commands and Companion Queries

These commands are used to modify the system parameters for the tester. These commands require a parameter value to be included with the command.

COMMAND	NAME	TEST TYPES
SPR {1 0} SPR?	PLC Remote ON/OFF	1=On, 0=Off
SSI {1 0} SSI?	Single Step ON/OFF	1=On, 0=Off
SF {1 0} SF?	Fail Stop ON/OFF	1=On, 0=Off
SEC 0 SEC n, mmm (n=1-2)	Edit Security	n: 0=off, 1=run, 2=mem, mmm=password
SEC?	Query security	0=OFF, 1=run, 2=mem
SDUT	Edit Dual Test	0=off, 1=ON
SDUT?	Query Dual Test	0=off, 1=on
SFW	Query Firmware version	Version

Query Commands

These query commands will retrieve data from the tester. These commands include functions for retrieving test data, test results and remote hardware.

COMMAND	NAME	TEST TYPES
TD?	List Testing Data	Data from test in Process
RD <mem number>?	Result Data Query	1-20
RR?	Read Reset Query	1=Open, 0=Closed
RI?	Read Interlock Query	1=Open, 0=Closed
LS?	List Step Parameters	
LS <mem number>?	List Step Parameters by step number	mem number 1-20
RDM?	Read Current Max	Returns max leakage recorded during Hipot test

REMOTE BUS INTERFACE: USB

TD? - Read the active data being displayed on the LCD display while the test is in process. It will also read the last data taken when the test sequence has completed. Each parameter is separated by commas and includes memory location, test type, test status, and metering. The syntax for this command response is {memory - step, test type, status, meter 1, meter 2, meter 3}.

{Memory, GND, Status, Current(A), Resistance(mΩ), Time(s)}

RD <mem number>? - Read the results for an individual memory location. Each parameter is separated by commas and includes memory location, test type, test status, and metering. The syntax for this command response is {memory - step, test type, status, meter 1, meter 2, meter 3}.

{Memory, GND, Status, Current(A), Resistance(mΩ), Time(s)}

RR? - Read the remote Reset input signal. When the remote reset has to be activated by closing the contacts the query will return a value of 0 to indicate the tester is being Reset.

RI? - Read the remote Interlock input signal. When the remote Interlock has to be activated by opening the contacts the query will return a value of 1 to indicate the tester is in the Interlock state and will not be able to generate output voltage or current.

LS? - Lists all the Parameters for the individual step that is currently selected.

The response will be formatted as follows;

{Memory, ACW, Status, Voltage(kV), Current(mA), Time(s)}

{Memory, DCW, Status, Voltage(kV), Current(mA), Time(s)}

{Memory, DCW, Status, Voltage(kV), Current(mA), Time(s)}

LS <memory location>? - Lists all parameters for the individual memories indicated by mem number = 1-20.

RDM? - Returns max leakage recorded during hipot test.

SFW? - Return the current firmware version of the tester.

REMOTE BUS INTERFACE: USB

IEEE 488.2 Common Commands

These commands are required by the IEEE-488.2 standard with the exception of *PSC, *PSC?. Most of these commands are not available over the RS-232 bus except for the *IDN? command which can be used to retrieve the tester identification information, and the four status reporting commands *ESR?, *ESE, *ESE? and *STB?.

Command	Name	Description
*IDN?	Identification Query	SLA, Model Number, Serial Number, Firmware Revision
*RST	Reset Command	Reset Tester
*TST?	Self-Test Query	00H=OK 01H=TEST EEPROM ERROR
*CLS	Clear Status Command	Clear Standard Event Status Register Clear Service Request Register
*OPC	Operation Complete Command	When TEST command ok setting ESR BIT0 =1
*OPC?	Operation Complete Query	1 = TEST completed ok 0 = TEST in process
*WAI	Wait-to-Continue Command	
*PSC {1 0}	Power-on Status Clear Command	1 = Power-on clear enable registers 0 = Power-on load previous enable registers
*PSC?	Power-on Status Clear Query	
*ESR?	Standard Event Status Register Query	BIT 0, 01H, (1) Operation Complete BIT 1, 02H, (2) Not Used BIT 2, 04H, (4) Query Error BIT 3, 08H, (8) Device Error BIT 4, 10H, (16) Execution Error BIT 5, 20H, (32) Command Error BIT 6, 40H, (64) Not Used BIT 7, 80H, (128) Power On
*ESE <value>	Standard Event Status Enable Command	value = 0 - 255
*ESE?	Standard Event Status Enable Query	0 - 255
*STB?	Read Status Byte Query	BIT 0, 01H, (1) ALL PASS BIT 1, 02H, (2) FAIL BIT 2, 04H, (4) ABORT BIT 3, 08H, (8) PROCESS BIT 4, 10H, (16) Message Available BIT 5, 20H, (32) Standard Event (ESB) BIT 6, 40H, (64) Request Service (MSS) BIT 7, 80H, (128) PROMPT
*SRE <value>	Service Request Enable Command	value = 0 - 255
*SRE?	Service Request Enable Query	0 - 255

REMOTE BUS INTERFACE: USB

***IDN?** - Read the tester identification string. Company =SLA.

***RST** - Reset the tester to original power on configuration. Does not clear Enable register for Standard Summary Status or Standard Event Registers. Does not clear the output queue. Does not clear the power-on-status-clear flag.

***TST?** - Performs a self test of the tester data memory. Returns 0 if it is successful or 1 if the test fails.

***CLS** - Clears the Status Byte summary register and event registers. Does not clear the Enable registers.

***OPC** - Sets the operation complete bit (bit 0) in the Standard Event register after a command is completed.

***OPC?** - Returns an ASCII "1" after the command is executed.

***WAI** - After the command is executed, it prevents the tester from executing any further query or commands until the no-operation-pending flag is TRUE.

***PSC {1|0}** - Sets the power-on status clear bit. When set to 1 the Standard Event Enable register and Status Byte Enable registers will be cleared when power is turned ON. 0 setting indicates the Enable registers will be loaded with Enable register masks from non-volatile memory at power ON.

***PSC?** - Queries the power-on status clear setting. Returns 0 or 1.

***ESR?** - Queries the Standard Event register. Returns the decimal value of the binary-weighted sum of bits.

***ESE <value>** - Standard Event enable register controls which bits will be logically ordered together to generate the Event Summary bit 5 (ESB) within the Status Byte.

***ESE?** - Queries the Standard Event enable register. Returns the decimal value of the binary-weighted sum of bits.

***STB?** - Read the Status Byte. Returns the decimal value of the binary-weighted sum of bits.

***SRE <value>** - Service Request enable register controls which bits from the Status Byte should be use to generate a service request when the bit value = 1.

***SRE?** - Queries the Service Request enable register. Returns the decimal value of binary-weighted sum of bits.

APPENDIX E - REPLACEMENT PART LIST - 440 SERIES

Supplied Accessories

Part Number	Qty	Ref. Designator	Description
99-10783-01	1	F10A	Fuse 10A Slow Blow 20mm, 446
99-10168-01	1	F15A	Fuse 15A Fast Blow 30mm, 448
99-10040-01	1	KEY-02-1	Interlock Connector
99-10865-01	1	-	High Current Test Cable (Red)
99-10866-01	1	-	High Current Test Cable (Return-black)
102-055-913	1	-	HV Test Lead 6ft.
99-10797-01	1	-	USB A-B 1.8M Cable
99-10963-01	1	-	Input Power Cable 15A/6Ft., 448
99-10726-01	1	-	USB Flash Drive (Product Manual)

Panel Components

Part Number	Qty	Ref. Designator	Description
99-10946-01	1	-	Fuse Holder 30mm, 448
99-10904-01	1	-	High Voltage Connector assembly, Front 446
99-10972-01	1	-	High Voltage Connector assembly, Front 448
99-10894-01	1	-	Output Return Terminal 80A Black
99-10895-01	1	-	Output Current Terminal 80A Red
99-10016-01	1	-	Earth Connector
330-113-001	1	-	Test Switch with Green LED Lamp
330-113-002	1	-	Reset Switch with Red LED Lamp
99-10850-01	1	OLED	LCD Display 16x2 Yellow
99-10735-01	1	ROTARY KEY	Rotary Knob 3cm
99-10762-01	2	-	Feet Rubber Insert-back
175-974-002	2	-	Feet Rubber Insert-front
99-10763-01	1	-	Feet Kit w/o Rubber Inserts

REPLACEMENT PART LIST - 440 SERIES

PCB Assemblies/Internal Components

Part Number	Qty	Ref. Designator	Description
99-10883-01	1	CONSCI440A	Main Control Board 446
99-10934-01	1	CONSCI440B	Main Control Board 448
99-10882-01	1	AMPSCI446	Amplifier Board 446
99-10932-01	1	AMPM001B	Amplifier Board 448
99-10933-01	1	FLYM001A	FLYBACK Board 448
99-10885-01	1	HVSCI440A	HV Relay Board 446
99-10936-01	1	HVSCI440B	HV Relay Board 448
99-10935-01	1	GBOSB100C	Ground Bond Output Relay Board 448
99-10884-01	1	EVRSCI440A	Encoder Board
99-10893-01	1	LEDM001B	LED Board
99-10905-01	1	-	Power Switch Assembly, 446
99-10974-01	1	-	Power Switch Assembly, 448
99-10886-01	1	T2	Output High Voltage Transformer , 446
99-10944-01	1	T2	Output 500VA HV Transformer, 448
99-10945-01	1	T3	Ground Bond Transformer, 448
99-10915-01	1	-	DC Fan 24V 60x60x25mm, 446
99-10784-01	1	-	DC Fan 24V 200mm, 448

APPENDIX F - SERVICE AND MAINTENANCE

User Service

To prevent electric shock do not remove the tester cover. There are no user serviceable parts inside. Routine maintenance or cleaning of internal parts is not necessary. Any external cleaning should be done with a clean dry or slightly damp cloth. Avoid the use of cleaning agents or chemicals to prevent any foreign liquid from entering the cabinet through ventilation holes or damaging controls and switches. Also some chemicals may damage plastic parts or lettering. Schematics, when provided, are for reference only. Any replacement cables and high voltage components should be acquired directly from SCI. Refer servicing to an SCI authorized service center.

SCI
28105 N. Keith Drive
Lake Forest, IL 60045-4546
USA

Phone 1 (847) 932-3662 or 1 (800) 504-0055
Fax 1 (847) 932-3665
Email support@hipot.com
Online hipot.com

Service Interval

The tester and its power cord, test leads, and accessories must be returned **at least once a year** to an SCI authorized service center for calibration and inspection of safety related components. SCI will not be held liable for injuries suffered if the tester is not returned for its annual safety check and maintained properly.

User Modifications

Unauthorized user modifications will void your warranty. SCI will not be responsible for any injuries sustained due to unauthorized equipment modifications or use of parts not specified by SCI. Testers returned to SCI with unsafe modifications will be returned to their original operating condition at your expense.

APPENDIX G - CALIBRATION PROCEDURE

This tester has been fully calibrated at the factory in accordance to our published specifications. It has been calibrated with standards traceable to NIST. You will find in this manual a copy of the "Certificate of Calibration". It is recommended that you have this tester recalibrated and a safety check done at least once per year. SCI recommends you use "Calibration Standards" that are NIST traceable, or traceable to agencies recognized by NIST to keep this tester within published specifications.

End user metrology standards or practices may vary. These metrology standards determine the measurement uncertainty ratio of the calibration standards being used. Calibration adjustments can only be made in the Calibration mode and calibration checks or verification can only be made while operation in Test mode.

Calibration Equipment Required

The following standard equipment will be needed to properly calibrate the 440 Series tester.

CALIBRATION PROCEDURE

- A Standard AC Voltmeter with 5,000 Volts range
- A Standard AC Voltmeter with 8 Volts range
- A Standard DC Voltmeter with 6,000 Volts range
- A Standard DC Voltmeter with 1,000 Volts range
- A Standard AC Ammeter with 40 A range
- A Standard AC Milliammeter with 20 mA range
- A Standard DC Milliammeter with 10 mA range
- A Standard Resistor 100 k Ω /20Watt/1500VAC (For 446)
- A Standard Resistor 100 k Ω /50Watt/2500VAC (For 448)
- A Standard Resistor 1 M Ω /0.25Watt/400VDC
- A Standard Resistor 50 M Ω /0.25Watt/1800VDC

1. Calibration Initialization

To enter the calibration mode the tester must be in the OFF position. Using a pen or small screwdriver, press and hold the recessed calibration key on the rear panel, then turn on the input POWER switch. The display will show:



To calibrate AC voltage please follow procedure on next step or to calibrate other parameters use the yellow rotary knob to scroll the desired calibration point, then follow the procedure on relative paragraph below. Below are the various calibration points available on the 440 Series:

- | | |
|--------------------------------------|---------------------|
| 1. 1-1 AC 5000V | 7. 11-1 DC 350.00uA |
| 1-2 AC 1000V | 11-2 DC 60.00uA |
| 2. 4-1 DC 6000V | 8. 12-1 DC 35.00uA |
| 4-2 DC 1000V | 12-2 DC 6.00uA |
| 4-3 IR 1000V | 9. 13-1 DC 3.500uA |
| 4-4 IR 100V | 13-2 DC 0.600uA |
| 3. 5-1 AC 10.00mA (446) ; 20mA (448) | 10. 15-1 GND 8.00V |
| 5-2 AC 6.00mA (446) ; 10mA (448) | 15-2 GND 0.500V |
| 4. 6-1 AC 4.00mA | 11. 16-1 GND 40.00A |
| 6-2 AC 0.60mA | 16-2 GND 5.00A |
| 5. 9-1 DC 5.00mA (446) ; 10mA (448) | |
| 9-2 DC 5.00mA (446) ; 8mA (448) | |
| 6. 10-1 DC 4.00mA | |
| 10-2 DC 0.60mA | |

CALIBRATION PROCEDURE

If there is an error or mistake during the entry of the calibration values, press the reset button to cancel or return to the previous menu.

When the calibration process is completed successfully and the tester accepts the entered calibration values it will output one short “beep” and advance to the next calibration point, otherwise the tester will output two short “beeps” and will not advance to the next calibration point.

2. To Calibration AC Voltage

Please connect a standard 5000V AC Voltmeter to the HV and RETURN connectors.

Then press the TEST button on the front panel. The tester will provide around 4500VAC on the output connectors and the display will show:



Turn and press the yellow rotary knob to enter the reading of the standard AC Voltmeter into the tester. Once all the digits are entered the tester will advance to the next calibration point.



Press the Test button on the front panel. The tester will provide around 1000VAC on the output connectors and the display will show:



Turn and press the yellow rotary knob to enter the reading of the standard AC Voltmeter into the tester. Once all the digits are entered the tester will advance to the next calibration point.

3. To calibrate DC Voltage

Please connect a standard 6000V DC Voltmeter to the HV and RETURN connectors.

Rotate the yellow knob until the display shows:



CALIBRATION PROCEDURE

Then press the TEST button on the front panel. The tester will provide around 6000VDC on the output connectors and the display will show:

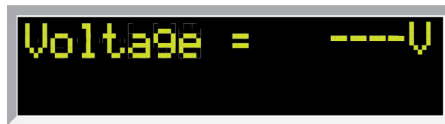

Turn and press the yellow rotary knob to enter the reading of the standard DC Voltmeter into the tester. Once all the digits are entered the tester will advance to the next calibration point.

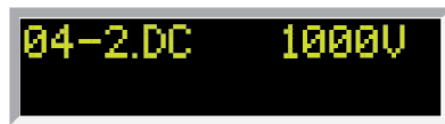

Press the TEST button on the front panel. The tester will provide around 1000VDC on the output connectors and the display will show:



Turn and press the yellow rotary knob to enter the reading of the standard DC Voltmeter into the tester. Once all the digits are entered the tester will advance to the next calibration point.



Press the TEST button on the front panel. The display will show:



Turn and press the yellow rotary knob to enter the reading of the standard DC Voltmeter into the tester. Once all the digits are entered the tester will advance to the next calibration point.



CALIBRATION PROCEDURE

Then press the TEST button on the front panel. The tester will provide around 100VDC on the output connectors and the display will show:



Turn and press the yellow rotary knob to enter the reading of the standard DC Voltmeter into the tester. Once all the digits are entered the tester will advance to the next calibration point.

4. To calibrate AC Current

Please connect a 100 k Ω resistor in series with the standard 20mA Autorange AC Milliammeter and connect these across the HV and RETURN connectors of the tester.

Note: Use 100k Ω 20 watts for model 446 and 50 watts for model 448.

Rotate the yellow rotary knob until the display shows:



Note: The above display is for 446. For 448, it will display 20mA

Then press the TEST button on the front panel. The tester will provide around 1000VAC(446)/2000VAC(448) on the output connectors and the display will show:



Turn and press the yellow rotary knob to enter the reading of the standard AC ammeter into the tester. Once all the digits are entered the tester will advance to the next calibration point.



Note: The above display is for 446. For 448, it will display 10mA

CALIBRATION PROCEDURE

Press the TEST button on the front panel. The tester will provide around 600VAC(446)/1000VAC(448) on the output connectors and the display will show:



Current = --.--mA

Turn and press the yellow rotary knob to enter the reading of the standard AC ammeter into the tester. Once all the digits are entered the tester will advance to the next calibration point.



06-1.AC 4.00mA
Load = 100k Ω

Press the TEST button on the front panel. The tester will provide around 400VAC on the output connectors and the display will show:



Current = --.--mA

Turn and press the yellow rotary knob to enter the reading of the standard AC ammeter into the tester. Once all the digits are entered the tester will advance to the next calibration point.



06-2.AC 0.60mA
Load = 100k Ω

CALIBRATION PROCEDURE

Press the TEST button on the front panel. The tester will provide around 80VAC on the output connectors and the display will show:



Turn and press the yellow rotary knob to enter the reading of the standard AC ammeter into the tester. Once all the digits are entered the tester will advance to the next calibration point.

5. To calibrate DC and IR Current

Please connect a 100 k Ω resistor in series with the standard 10mA Autorange AC milliammeter and connect these across the HV and RETURN connectors of the tester.

Rotate the yellow rotary knob until the display shows:



Note: The above display is for 446. For 448, it will display 10.00mA

Press the TEST button on the front panel. The tester will provide around 500Vdc(446)/1000Vdc(448) on the output connectors and the display will show:



Turn and press the yellow rotary knob to enter the reading of the standard DC ammeter into the tester. Once all the digits are entered the tester will advance to the next calibration point.



Note: The above display is for 446. For 448, it will display 8.00mA

CALIBRATION PROCEDURE

Press the TEST button on the front panel. The tester will provide around 500Vdc(446)/800Vdc(448) on the output connectors and the display will show:



Current = --.--mA

Turn and press the yellow rotary knob to enter the reading of the standard DC ammeter into the tester. Once all the digits are entered the tester will advance to the next calibration point.



10-1.DC 4.00mA
Load = 100k Ω

Press the TEST button on the front panel. The tester will provide around 400VDC on the output connectors and the display will show:



Current = --.--mA

Turn and press the yellow rotary knob to enter the reading of the standard DC ammeter into the tester. Once all the digits are entered the tester will advance to the next calibration point.

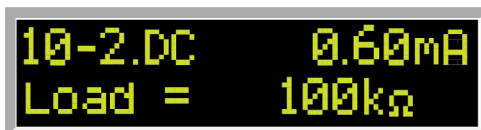

10-2.DC 0.60mA
Load = 100k Ω

CALIBRATION PROCEDURE

Press the TEST button on the front panel. The tester will provide around 80VAC on the output connectors and the display will show:



Current = --.--mA

Turn and press the yellow rotary knob to enter the reading of the standard DC ammeter into the tester. Once all the digits are entered the tester will advance to the next calibration point.



11-1.DC 350.0uA
Load = 1M Ω

At this point, please replace the Load Resistor with 1 M Ω resistor in series with the standard 1mA Autorange DC milliammeter and connect these across the HV and RETURN connectors of the tester.

Press the TEST button on the front panel. The tester will provide around 350Vdc on the output connectors and the display will show:



Current = --.--uA

Turn and press the yellow rotary knob to enter the reading of the standard DC ammeter into the tester. Once all the digits are entered the tester will advance to the next calibration point.



11-2.DC 60.0uA
Load = 1M Ω

CALIBRATION PROCEDURE

Press the TEST button on the front panel. The tester will provide around 60Vdc on the output connectors and the display will show:



Current = --.--uA

Turn and press the yellow rotary knob to enter the reading of the standard DC ammeter into the tester. Once all the digits are entered the tester will advance to the next calibration point.



12-1.DC 35.00uA
Load = 50M Ω

At this point, please replace the Load Resistor with 50 M Ω resistor in series with the standard 1mA Autorange DC milliammeter and connect these across the HV and RETURN connectors of the tester.

Press the TEST button on the front panel. The tester will provide around 1750Vdc on the output connectors and the display will show:



Current = --.--uA

Turn and press the yellow rotary knob to enter the reading of the standard DC ammeter into the tester. Once all the digits are entered the tester will advance to the next calibration point.



12-2.DC 6.00uA
Load = 50M Ω

Press the TEST button on the front panel. The tester will provide around 300Vdc on the output connectors and the display will show:



Current = --.--uA

CALIBRATION PROCEDURE

Turn and press the yellow rotary knob to enter the reading of the standard DC ammeter into the tester. Once all the digits are entered the tester will advance to the next calibration point.



13-1.DC 3.500uA
Load = 50MΩ

Press the TEST button on the front panel. The tester will provide around 175Vdc on the output connectors and the display will show:



Current = .---uA

Turn and press the yellow rotary knob to enter the reading of the standard DC ammeter into the tester. Once all the digits are entered the tester will advance to the next calibration point.



13-2.DC 0.600uA
Load = 50MΩ

Press the TEST button on the front panel. The tester will provide around 30Vdc on the output connectors and the display will show:



Current = .---uA

Turn and press the yellow rotary knob to enter the reading of the standard DC ammeter into the tester. Once all the digits are entered the tester will advance to the next calibration point.

6. To calibrate Ground Bond voltage

Please connect a standard AC Voltmeter across the CURRENT and RETURN connectors of the tester.

Rotate the yellow rotary knob until the display shows:



15-1.GND 8.000V

CALIBRATION PROCEDURE

Then press the TEST button on the front panel. The tester will provide around 8Vac on the output connectors and the display will show:



Turn and press the yellow rotary knob to enter the reading of the standard AC voltmeter into the tester. Once all the digits are entered the tester will advance to the next calibration point.



Press the TEST button on the front panel. The tester will provide around 0.5Vac on the output connectors and the display will show:



Turn and press the yellow rotary knob to enter the reading of the standard AC voltmeter into the tester. Once all the digits are entered the tester will advance to the next calibration point.

7. To calibrate Ground Bond test current

Please connect the standard 40A AC Ammeter across the CURRENT and RETURN connectors of the tester.

Rotate the yellow rotary knob until the display shows:



CALIBRATION PROCEDURE

Press the TEST button on the front panel. The tester will provide around 40 Amperes on the output connectors and the display will show:



Current = --.--A

Turn and press the yellow rotary knob to enter the reading of the standard AC Ammeter into the tester. Once all the digits are entered the tester will advance to the next calibration point.



16-2.GND 5.0A

Then press the TEST button on the front panel. The tester will provide around 40 Amperes on the output connectors and the display will show:



Current = -.--A

Turn and press the yellow rotary knob to enter the reading of the standard AC Ammeter into the tester.

8. Exit Calibration Mode

When all calibration parameters are completed successfully, it will display the calibration complete for about 3 seconds then automatically exits the calibration and Power cycle the tester.



Calibration
complete