

WAVECOM® W74PC

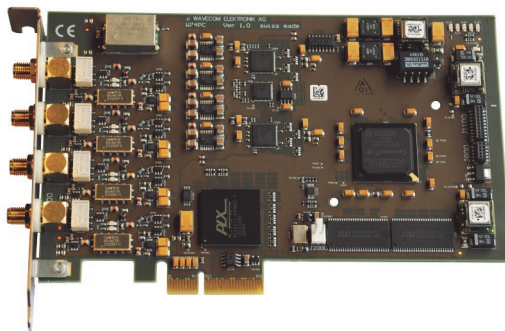

W74PC offers four completely independent Digital Down Converter (DDC) inputs at IF and AF level, ideally suited for connection to narrowband and broadband receivers and wideband down converters. With two simultaneous and independent decoding instances on one card, W74PC delivers a modern complete solution in classification, decoding and monitoring with various interfaces in hardware and software and includes all functionalities of W-CODE.

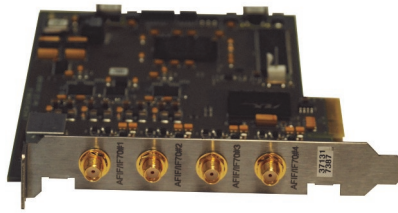

W74PC

The Complete Solution for Decoding and Monitoring

WAVECOM®
NACHRICHTENTECHNIK

W74PC Features and Facts

- ◆ W74PC offers four high-quality DDC inputs with wideband frequency range. The DDCs extract the narrowband signal of interest from a broadband input signal. The extracted signal is then used for further analysis, decoding and recording.
- ◆ W74PC card in a compact design: four SMA connectors, each switchable to AFIF (0-25 MHz) and IF 70 MHz by a mini signal relay.
- ◆ W74PC does not need a USB license dongle. The key is integrated in the card.
- ◆ W74PC provides all functions required to analyze, decode, record and process radio data communications throughout the radio spectrum from HF, VHF, UHF to SHF.
- ◆ W74PC includes all functionalities of W-CODE.
- ◆ Two lines of decoding on one card: genuine simultaneous dual instance decoding of two different signals.
- ◆ W74PC supports automatic classification, code check, demodulation and decoding to content level (text, live voice or image etc.) of signals and predefined unknown signals.
- ◆ The easy-to-use graphical user interface (GUI) with well-structured pull-down menus allows an operator to rapidly get familiar with W74PC decoder software.
- ◆ A W74PC card can be controlled from anywhere via the Internet, an Ethernet LAN or a W-LAN.
- ◆ W74PC supports remote control from other applications using third party software with TCP/IP and XML.
- ◆ The implementation of complex systems for monitoring is limited only by the performance of the hardware and software.

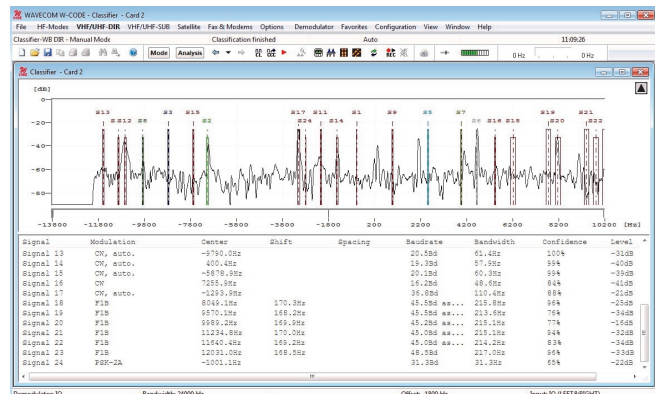

Classifier-WB display containing 24 identified signals



Simultaneous dual channel decoding on one W74PC card: STANAG4285 on AF#4 (instance 1) and SAT signals on IF70#1 (instance 2)

Signal Sources and Devices

- ◆ System components can be individually configured according to the requirements of the customer.
- ◆ The application processing the W74PC input is compatible to W-CODE. The Device Selector supports a great number of input interfaces and devices. W74PC supports dual IF inputs from 0 – 25 MHz or 70 MHz +/-17.5 MHz.
- ◆ W74PC is a universal signal interface and can be installed in any PC with PCIe x4 card slots.
- ◆ A number of other interfaces, e.g. SDR I/Q data or digital TCP/IP input streams using W-CLOUD, IP-PXGF, Virtual Audio Cable (VAC) or WiNRADiO Digital Bridge Virtual Sound Card (VSC) are also available with W74PC.

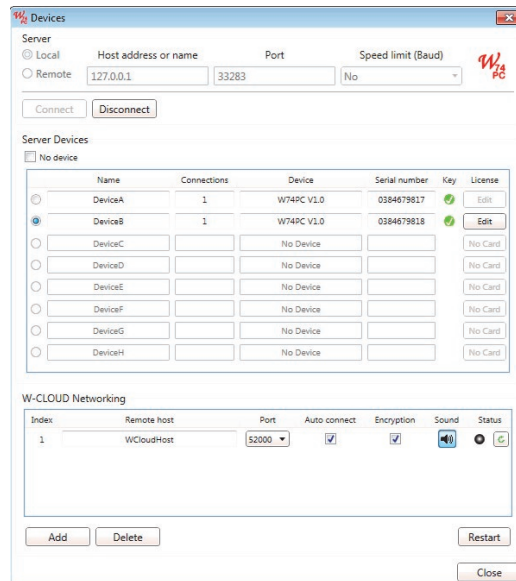

Device selector in W74PC: one card is listed as two instances for simultaneous decoding

- ◆ W74PC is configured with four independent Digital Down Converters (DDC) corresponding to the well-known Software Defined Radio (SDR) technology.

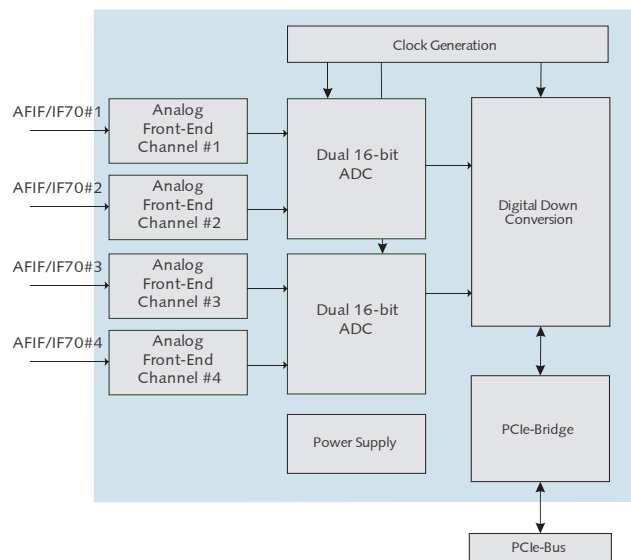

W74PC block diagram

W74PC

The Complete Solution for Decoding and Monitoring

WAVECOM®
NACHRICHTENTECHNIK

Wide Range of Applications

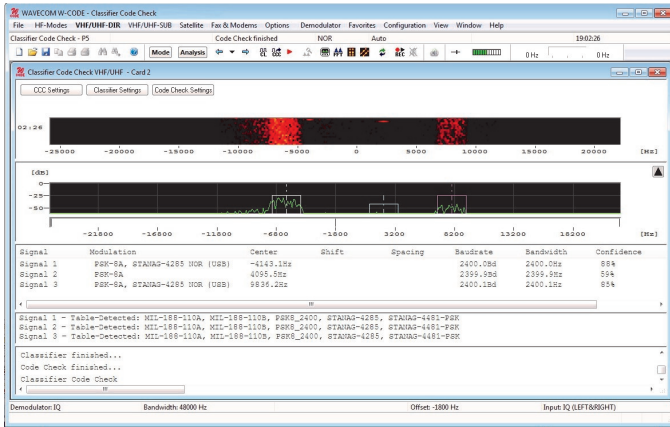

Automatic Signal Classification

Data Decoding

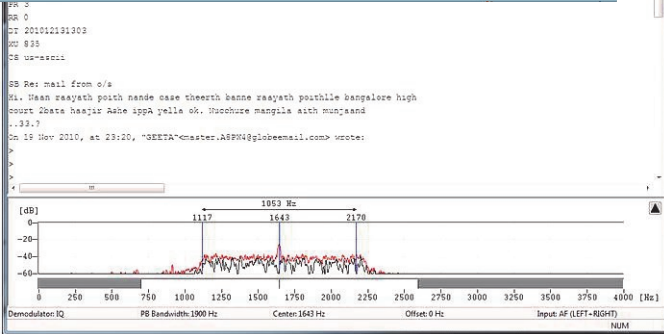

Signal Analysis

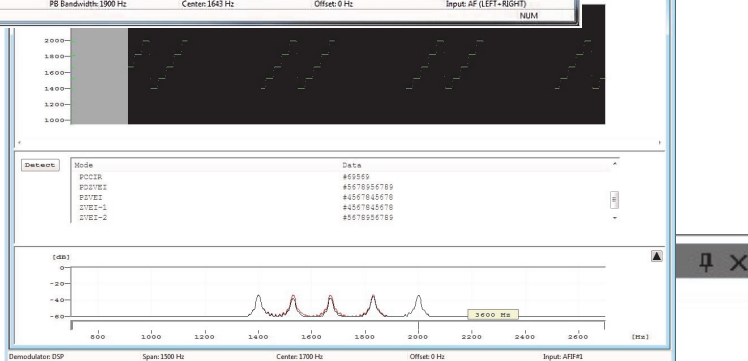

Bit Analysis

- Extraction (Mask)
- test STANAG 4285 Descrambler
- test Symbol Transcoding
- Extraction (Mask)
- test STANAG-4285 DeInterleaver
- test Stream setup for Viterbi
- Viterbi
- Mirroring
- ASCII
- UTF-8

W74PC

The Complete Solution for Decoding and Monitoring

WAVECOM®
NACHRICHTENTECHNIK

Practical Application

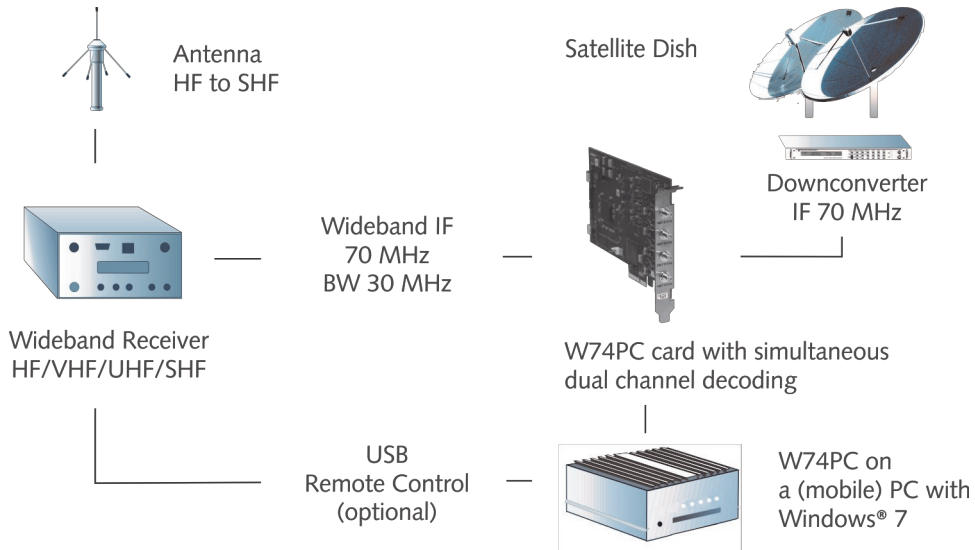

W74PC and wideband receiver configuration

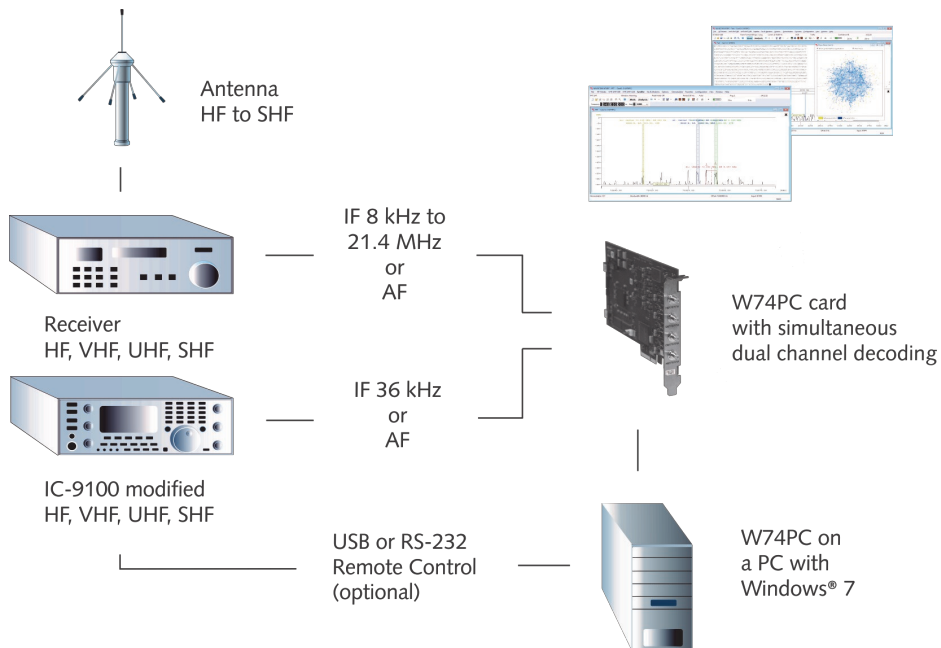

W74PC and IF or AF configuration

W74PC

The Complete Solution for Decoding and Monitoring

Satellite Application

Inmarsat monitoring is an integral part of the wide range of modes available for the Wavecom suite of decoders. W74PC decoder functions include

- ◆ Real-time voice (Inmarsat B and M), data and fax decoding
- ◆ SAT-AERO decoding
- ◆ Remote control interface enabling customers to build their own customized monitoring system
- ◆ Output can be fed to optional W-SAT -email decoder

The Inmarsat system covers four ocean regions, each served by a satellite. A Network Coordination Station (NCS) in each region assigns a free traffic frequency, timeslot or logical channel to the session between the Mobile Earth Station (MES) and the Land Earth Station (LES). After the session has terminated, the frequency, time slot or logical channel is returned to the common resource pool.

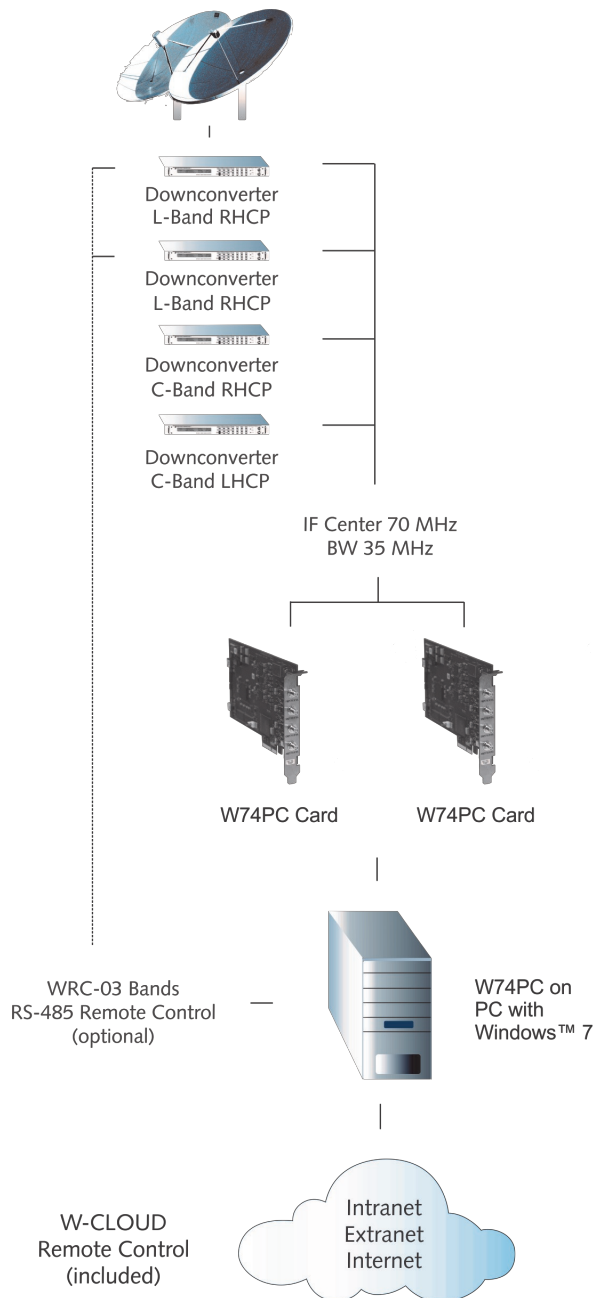





W74PC

The Complete Solution for Decoding and Monitoring

WAVECOM
NACHRICHTENTECHNIK

W74PC Card Specifications and Technical Data

Inputs	AFIF#1 — AFIF#4	IF70#1 — IF70#4
Connector	SMA female	SMA female
Frequency range	50 Hz to 25 MHz	52.5 MHz to 87.5 MHz (SAW filter)
Bandwidth	5 kHz to 500 kHz	5 kHz to 500 kHz
Frequency raster DDC	< 1.0 Hz	< 1.0 Hz
Signal level	2 mVrms to 0.5 Vrms	20 mVrms to 2.5 Vrms
Input impedance	> 1 kOhm	50 Ohm
Input max sampling rate	98.304 MHz	98.304 MHz
Input sampling rate jitter	< 1 ps (RMS 12 kHz to 20 MHz)	< 1 ps (RMS 12 kHz to 20 MHz)
Available for mode group	HF / VHF / UHF / Fax and Modem	HF / VHF / UHF / SAT

Card type	Half-size PCIe card (PCI Express x 4 slot)
Number of concurrent, independent inputs	Four SMA connectors: AFIF/IF70#1 — AFIF/IF70#4, each switchable by a mini signal relay
Dimensions (L x W x H)	168 x 106 x 22 mm
Weight	0.15 kg
Power requirement (typical values)	< 25W
Bus interface	PCIe x4 Link 2 Gbit/s
Operating temperature range	0 °C to 50 °C
Case temperature range	0 °C to 55 °C
Storage temperature range	0 °C to 70 °C
Relative humidity	10 to 90 % (non-condensing)
A/D converter	2 x AD9268 dual 16 bit ADC
Dynamic range	> 60 dB
Digital down converter DDC	FPGA Cyclone IV
Oscillator and clock	High stability temperature compensated crystal oscillator Low phase noise clock distribution
Watchdog for on-board generated voltages	Yes
License key	Built-in license, no external USB dongle necessary
Conformity	   

W74PC

The Complete Solution for Decoding and Monitoring

WAVECOM[®]
NACHRICHTENTECHNIK

Since more than thirty years Wavecom Elektronik AG has developed, manufactured and distributed high quality devices and software for the decoding and retrieval of information from wireless data communication in all frequency bands. The nature

of the data communication may be arbitrary, but commonly contains text, images and voice. The company is internationally established within this industry and maintains a longstanding, world-wide network of distributors and business partners.

Product Information

Products	http://www.wavecom.ch/product-summary.php
Datasheets	http://www.wavecom.ch/brochures.php
Specifications	http://www.wavecom.ch/product-specifications.php
Documentation	http://www.wavecom.ch/manuals.php
Online help	http://www.wavecom.ch/content/ext/DecoderOnlineHelp/default.htm
Software warranty	One year free releases and bug fixes, update by DVD
Hardware warranty	Two years hardware warranty
Prices	http://www.wavecom.ch/contact-us.php

System Requirements and Ordering Information

	<i>Minimum</i>	<i>Recommended</i>
CPU	P4 Dual-Core 2.4 GHz	Core i5 or Core i7 2.8 GHz
Memory	2 GB RAM	4 - 8 GB RAM
OS	Windows XP	Windows 7 32-bit or Windows 7 64-bit

Product Code	Description
W74PC	Four channel PCI Express x 4 bus PC card with decoder software on a in-card license
WLW	Vocoder live voice output to the speaker. Option for W-CODE, W74PC, W-PCIe, W-PCI and W-SPECTRA
WHWL2	Second license for simultaneous decoding. Available for W-PCI, W-PCIe and W74PC cards

Distributors and Regional Contacts

You will find a list of distributors and regional contacts at <http://www.wavecom.ch/distributors.php>

WAVECOM[®]

NACHRICHTENTECHNIK

WAVECOM ELEKTRONIK AG, Hammerstrasse 8
8180 Buelach, Switzerland
Phone +41 44 872 70 60 Fax +41 44 872 70 66
E-Mail: sales@wavecom.ch
Internet: www.wavecom.ch

© WAVECOM[®] ELEKTRONIK AG - Brochure 2020 - All rights reserved

Microsoft, Encarta, MSN and Windows are either registered trademarks or trademarks of Microsoft Corporation in the United States and/or other countries. WINRADIO[®] is a registered trademark of Radixon Group Pty. Ltd. and Rosetta Laboratories Pty Ltd. ICOM[®] logo is a registered trademark of Icom Incorporated (Japan) in Japan.